

TPS3600D20, TPS3600D25, TPS3600D33, TPS3600D50 BATTERY-BACKUP SUPERVISORS FOR LOW-POWER PROCESSORS

SLVS336B – DECEMBER 2000 – REVISED JANUARY 2007

features

- Supply Current of 40 μ A (Max)
- Precision Supply Voltage Monitor
 - 2.0 V, 2.5 V, 3.3 V, 5.0 V
 - Other Versions on Request
- Watchdog Timer With 800-ms Time-Out
- Backup-Battery Voltage Can Exceed V_{DD}
- Power-On Reset Generator With Fixed 100-ms Reset Delay Time
- Battery OK Output
- Voltage Monitor for Power-Fail or Low-Battery Monitoring
- Manual Switchover to Battery-Backup Mode
- Chip-Enable Gating –3 ns (at $V_{DD} = 5$ V)
Max. Propagation Delay
- Manual Reset
- Battery Freshness Seal
- 14-Pin TSSOP Package
- Temperature Range . . . -40°C to 85°C

typical applications

- Fax Machines
- Set-Top Boxes
- Advanced Voice Mail Systems
- Portable Battery Powered Equipment
- Computer Equipment
- Advanced Modems
- Automotive Systems
- Portable Long-Time Monitoring Equipment
- Point of Sale Equipment

TSSOP (PW) Package
(TOP VIEW)

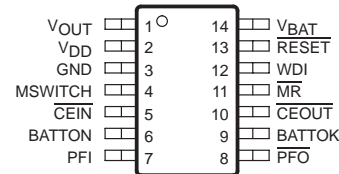

ACTUAL SIZE
(5,10mm x 6,60mm)

typical operating circuit

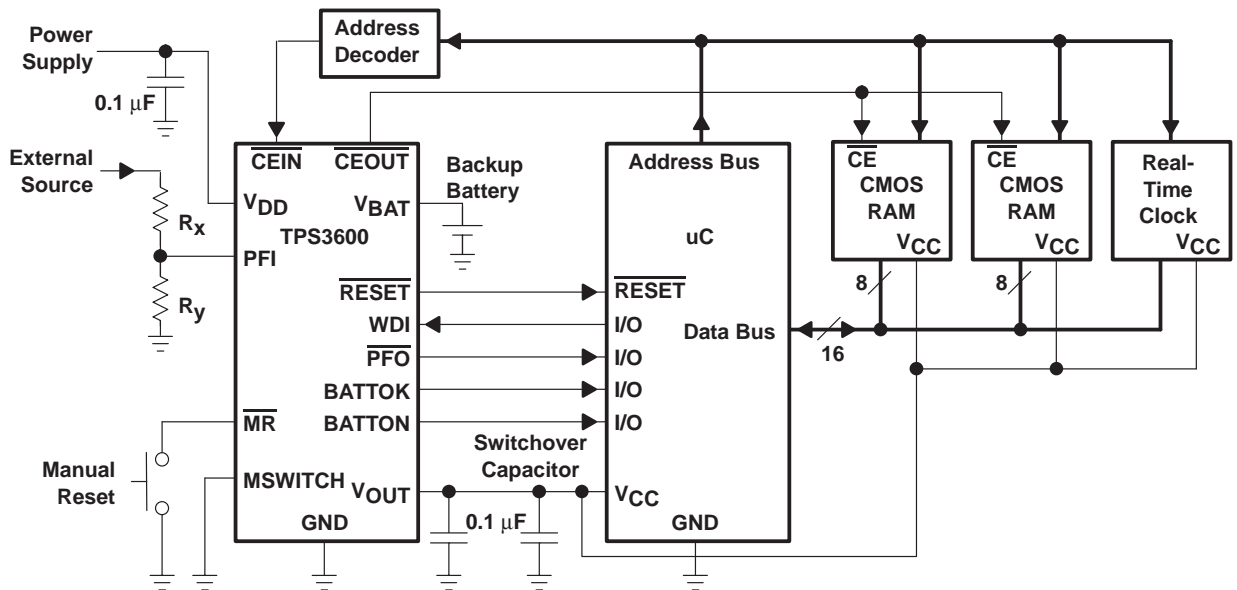

Please be aware that an important notice concerning availability, standard warranty, and use in critical applications of Texas Instruments semiconductor products and disclaimers thereto appears at the end of this data sheet.

All trademarks are the property of their respective owners.

PRODUCTION DATA information is current as of publication date. Products conform to specifications per the terms of Texas Instruments standard warranty. Production processing does not necessarily include testing of all parameters.

**TEXAS
INSTRUMENTS**
www.ti.com

Copyright © 2000–2007, Texas Instruments Incorporated

TPS3600D20, TPS3600D25, TPS3600D33, TPS3600D50 BATTERY-BACKUP SUPERVISORS FOR LOW-POWER PROCESSORS

SLVS336B – DECEMBER 2000 – REVISED JANUARY 2007

description

The TPS3600 family of supervisory circuits monitor and control processor activity. In case of power-fail or brownout conditions, the backup-battery switchover function of TPS3600 allows to run a low-power processor and its peripherals from the installed backup battery without asserting a reset beforehand.

During power on, $\overline{\text{RESET}}$ is asserted when the supply voltage (V_{DD} or V_{BAT}) becomes higher than V_{res} . Thereafter, the supply voltage supervisor monitors V_{OUT} and keeps $\overline{\text{RESET}}$ output active as long as V_{OUT} remains below the threshold voltage (V_{IT}). An internal timer delays the return of the output to the inactive state (high) to ensure proper system reset. This delay timer starts its time-out, after V_{OUT} has risen above the threshold voltage (V_{IT}). In case of a brownout or power failure of both supply sources, a voltage drop below the threshold voltage (V_{IT}) get detected and the output becomes active (low) again.

The product spectrum is designed for supply voltages of 2 V, 2.5 V, 3.3 V, and 5 V. The circuits are available in a 14-pin TSSOP package. They are characterized for operation over a temperature range of -40°C to 85°C .

PACKAGE INFORMATION

T_A	DEVICE NAME
-40°C to 85°C	TPS3600D20
	TPS3600D25
	TPS3600D33
	TPS3600D50

ordering information application specific versions (see Note)

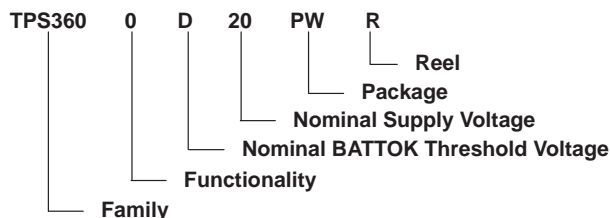

DEVICE NAME	NOMINAL VOLTAGE, V_{NOM}
TPS3600x20 PW	2.0 V
TPS3600x25 PW	2.5 V
TPS3600x33 PW	3.3 V
TPS3600x50 PW	5.0 V

DEVICE NAME	NOMINAL BATTOK THRESHOLD VOLTAGE, V_{BOK}
TPS3600Dxx PW	$V_{\text{IT}} + 7\%$
TPS3600Fxx PW [†]	$V_{\text{IT}} + 6\%$
TPS3600Hxx PW [†]	$V_{\text{IT}} + 8\%$
TPS3600Jxx PW [†]	$V_{\text{IT}} + 10\%$

[†] For the application specific versions, please contact the local TI sales office for availability and lead time.

TPS3600D20, TPS3600D25, TPS3600D33, TPS3600D50 BATTERY-BACKUP SUPERVISORS FOR LOW-POWER PROCESSORS

SLVS336B – DECEMBER 2000 – REVISED JANUARY 2007

FUNCTION TABLES

$V_{DD} > V_{SW}$	$V_{OUT} > V_{IT}$	$V_{DD} > V_{BAT}$	MSWITCH	\overline{MR}	V_{OUT}	BATTON	\overline{RESET}	\overline{CEOUT}
0	0	0	0	0	V_{BAT}	1	0	DIS
0	0	0	0	1	V_{BAT}	1	0	DIS
0	0	0	1	0	V_{BAT}	1	0	DIS
0	0	0	1	1	V_{BAT}	1	0	DIS
0	0	1	0	0	V_{DD}	0	0	DIS
0	0	1	0	1	V_{DD}	0	0	DIS
0	0	1	1	0	V_{BAT}	1	0	DIS
0	0	1	1	1	V_{BAT}	1	0	DIS
0	1	0	0	0	V_{BAT}	1	0	DIS
0	1	0	0	1	V_{BAT}	1	1	EN
0	1	0	1	0	V_{BAT}	1	0	DIS
0	1	0	1	1	V_{BAT}	1	1	EN
0	1	1	0	0	V_{DD}	0	0	DIS
0	1	1	0	1	V_{DD}	0	1	EN
0	1	1	1	0	V_{BAT}	1	0	DIS
0	1	1	1	1	V_{BAT}	1	1	EN
1	1	0	0	0	V_{DD}	0	0	DIS
1	1	0	0	1	V_{DD}	0	1	EN
1	1	0	1	0	V_{BAT}	1	0	DIS
1	1	0	1	1	V_{BAT}	1	1	EN
1	1	1	0	0	V_{DD}	0	0	DIS
1	1	1	0	1	V_{DD}	0	1	EN
1	1	1	1	0	V_{BAT}	1	0	DIS
1	1	1	1	1	V_{BAT}	1	1	EN

$V_{BAT} > V_{BOK}$	BATTOK
0	0
1	1

CONDITION: $V_{OUT} > V_{DD(min)}$

\overline{CEIN}	\overline{CEOUT}
0	0
1	1

CONDITION: Enabled

$PFI > V_{PFI}$	\overline{PFO}
0	0
1	1

CONDITION: $V_{OUT} > V_{DD(min)}$

TPS3600D20, TPS3600D25, TPS3600D33, TPS3600D50 BATTERY-BACKUP SUPERVISORS FOR LOW-POWER PROCESSORS

SLVS336B – DECEMBER 2000 – REVISED JANUARY 2007

functional schematic

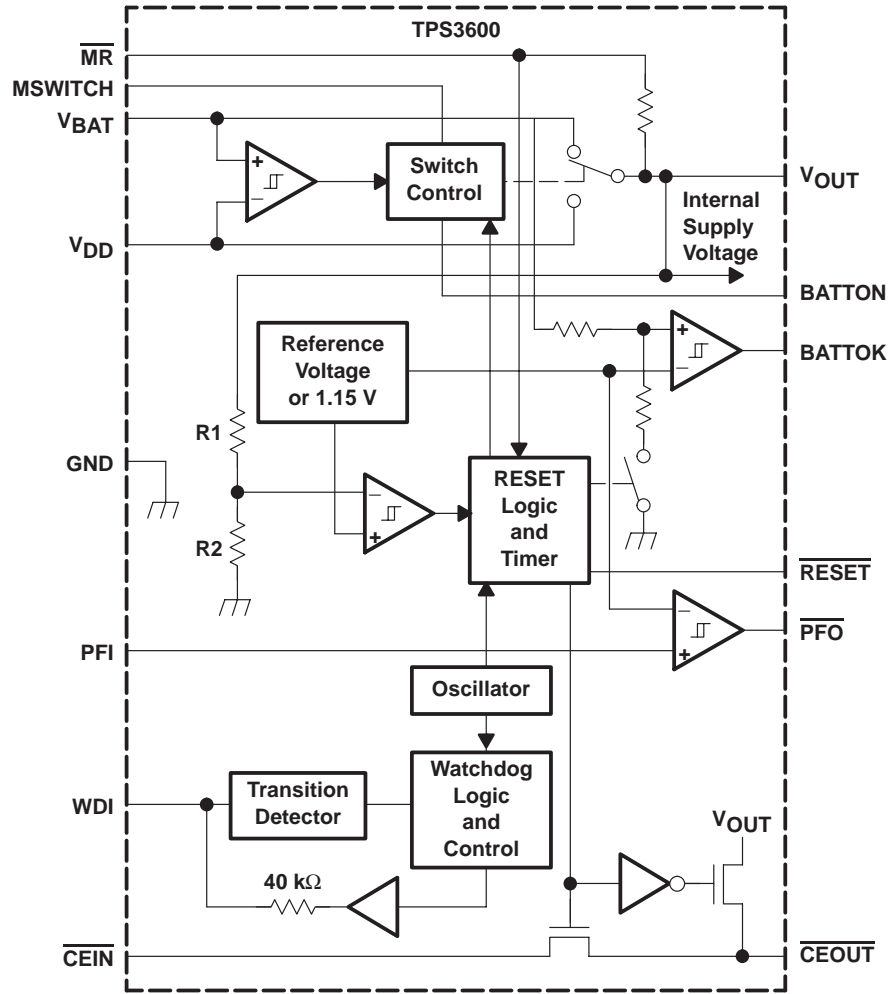

TPS3600D20, TPS3600D25, TPS3600D33, TPS3600D50 BATTERY-BACKUP SUPERVISORS FOR LOW-POWER PROCESSORS

SLVS336B – DECEMBER 2000 – REVISED JANUARY 2007

timing diagram

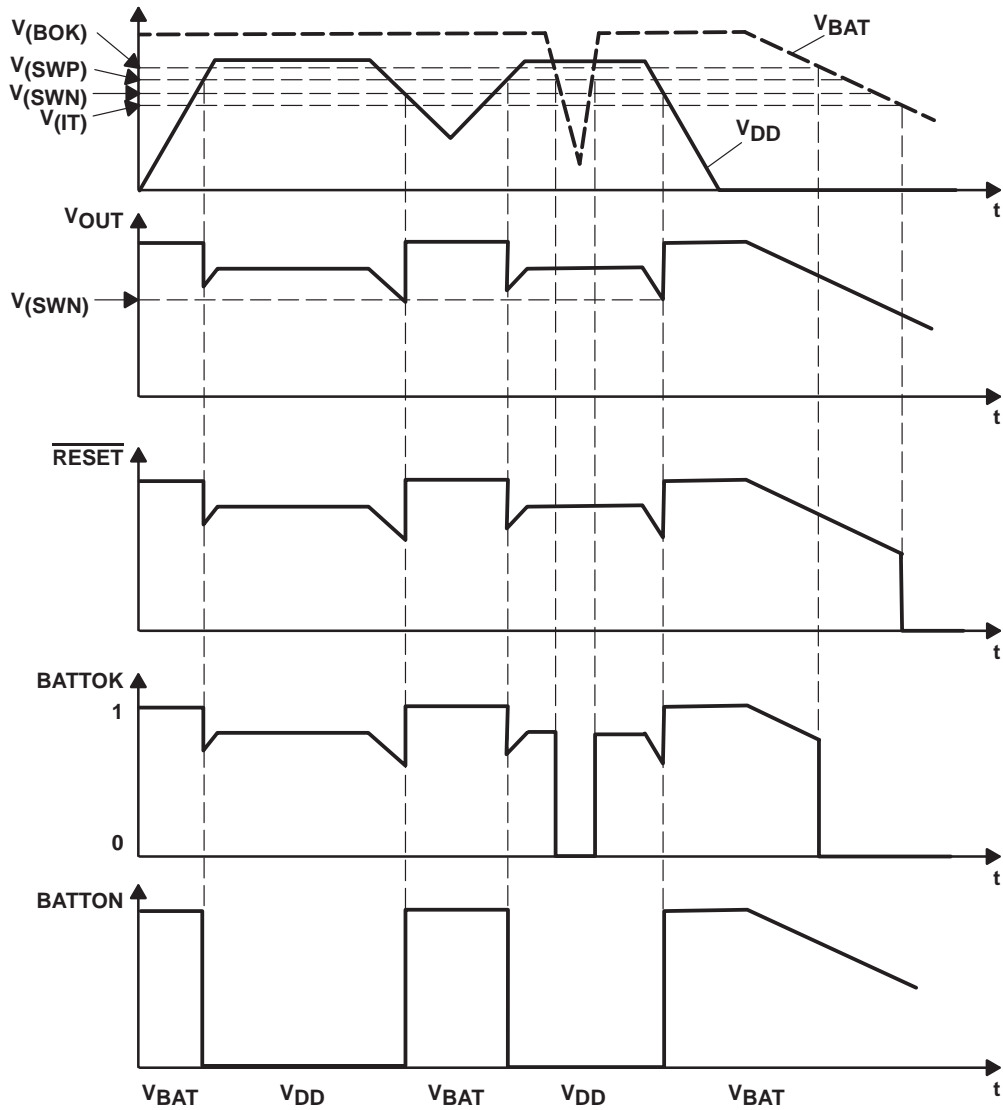

NOTES: A. $MSWITCH = 0$, $\overline{MR} = 1$

NOTES: B. Timing diagram shown under normal operation, not in freshness seal mode.

TPS3600D20, TPS3600D25, TPS3600D33, TPS3600D50 BATTERY-BACKUP SUPERVISORS FOR LOW-POWER PROCESSORS

SLVS336B – DECEMBER 2000 – REVISED JANUARY 2007

Terminal Functions

TERMINAL NAME	NO.	I/O	DESCRIPTION
BATTOK	9	O	Battery status output
BATTON	6	O	Logic output/external bypass switch driver output
$\overline{\text{CEIN}}$	5	I	Chip-enable input
$\overline{\text{CEOUT}}$	10	O	Chip-enable output
GND	3	I	Ground
MR	11	I	Manual reset input
MSWITCH	4	I	Manual switch to force device into battery-backup mode (connect to GND if not used)
PFI	7	I	Power-fail comparator input (connect to GND if not used)
$\overline{\text{PFO}}$	8	O	Power-fail comparator output
$\overline{\text{RESET}}$	13	O	Active-low reset output
V _{BAT}	14	I	Backup-battery input
V _{DD}	2	I	Input supply voltage
V _{OUT}	1	O	Supply output
WDI	12	I	Watchdog timer input

detailed description

battery freshness seal

The battery freshness seal of the TPS3600 family disconnects the backup battery from the internal circuitry until it is needed. This ensures that the backup battery connected to V_{BAT} should be fresh when the final product is put to use. The following steps explain how to enable the freshness seal mode:

1. Connect V_{BAT} (V_{BAT} > V_{BAT(min)})
2. Ground $\overline{\text{PFO}}$
3. Connect PFI to V_{DD} or PFI > V_(PFI)
4. Connect V_{DD} to power supply (V_{DD} > V_{IT})
5. Ground $\overline{\text{MR}}$
6. Power down V_{DD}
7. The freshness seal mode is entered and pins $\overline{\text{PFO}}$ and $\overline{\text{MR}}$ can be disconnected.

The battery freshness seal mode is disabled by the positive-going edge of $\overline{\text{RESET}}$ when V_{DD} is applied.

BATTOK output

This is a logic feedback of the device to indicate the status of the backup battery. The supervisor checks the battery voltage every 200 ms with a voltage divider load of approximately 100 K Ω and a measure cycle on-time of 25 μ s. This measurement cycle starts after the reset is released. If the battery voltage V_{BAT} is below the negative-going threshold voltage V_(BOK), the indicator BATTOK does a high-to-low transition. Otherwise, its status remains to the V_{OUT} level.

Table 1. Typical Values for BATTOK Indication

SUPERVISOR TYPE	V _{IT} TYP	V _{BOK} MIN	V _{BOK} TYP	V _{BOK} MAX
TPS3600D20	1.78 V	1.84 V	1.91 V	1.97 V
TPS3600D25	2.22 V	2.3 V	2.38 V	2.46 V
TPS3600D33	2.93 V	3.04 V	3.14 V	3.24 V
TPS3600D50	4.40 V	4.56 V	4.71 V	4.86 V

detailed description (continued)

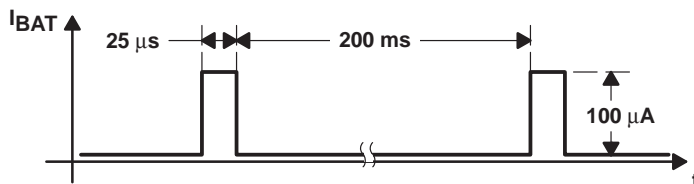

Figure 1. BATTOK Timing

chip-enable signal gating

The internal gating of chip-enable signals (CE) prevents erroneous data from corrupting CMOS RAM during an under-voltage condition. The TPS3600 use a series transmission gate from \overline{CEIN} to \overline{CEOUT} . During normal operation (reset not asserted), the CE transmission gate is enabled and passes all CE transitions. When reset is asserted, this path becomes disabled, preventing erroneous data from corrupting the CMOS RAM. The short CE propagation delay from \overline{CEIN} to \overline{CEOUT} enables the TPS3600 devices to be used with most processors.

The CE transmission gate is disabled and \overline{CEIN} is high impedance (disable mode) while reset is asserted. During a power-down sequence when V_{DD} crosses the reset threshold, the CE transmission gate will be disabled and \overline{CEIN} immediately becomes high impedance if the voltage at \overline{CEIN} is high. If \overline{CEIN} is low during reset is asserted, the CE transmission gate will be disabled same time when \overline{CEIN} goes high, or $15 \mu s$ after reset asserts, whichever occurs first. This will allow the current write cycle to complete during power down. When the CE transmission gate is enabled, the impedance of \overline{CEIN} appears as a resistor in series with the load at \overline{CEOUT} . The overall device propagation delay through the CE transmission gate depends on V_{OUT} , the source impedance of the device connected to \overline{CEIN} and the load at \overline{CEOUT} . To achieve minimum propagation delay, the capacitive load at \overline{CEOUT} should be minimized, and a low-output-impedance driver be used.

During disable mode, the transmission gate is off and an active pullup connects \overline{CEOUT} to V_{OUT} . This pullup turns off when the transmission gate is enabled.

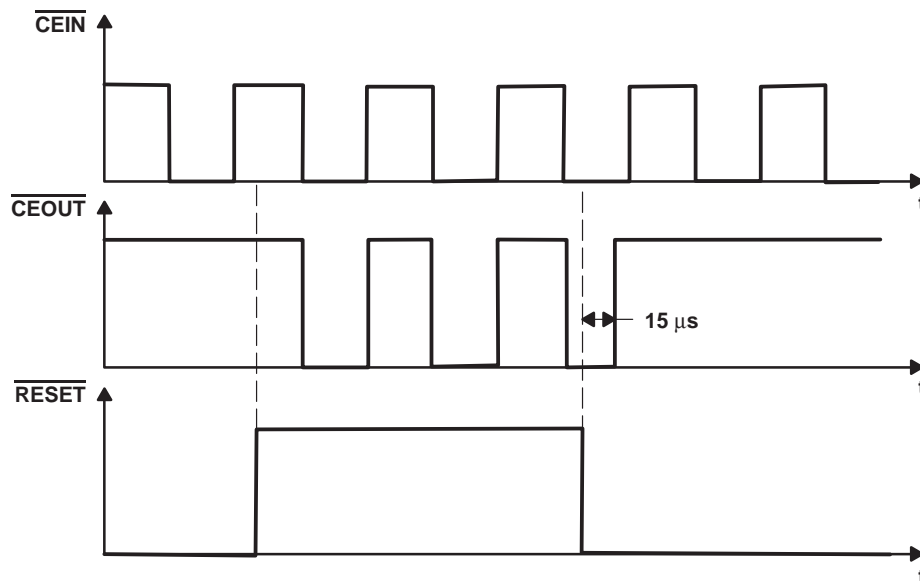

Figure 2. Chip-Enable Timing

TPS3600D20, TPS3600D25, TPS3600D33, TPS3600D50 BATTERY-BACKUP SUPERVISORS FOR LOW-POWER PROCESSORS

SLVS336B – DECEMBER 2000 – REVISED JANUARY 2007

detailed description (continued)

power-fail comparator (PFI and $\overline{\text{PFO}}$)

An additional comparator is provided to monitor voltages other than the nominal supply voltage. The power-fail input (PFI) will be compared with an internal voltage reference of 1.15 V. If the input voltage falls below the power-fail threshold, $V_{(\text{PFI})}$, of 1.15 V typical, the power-fail output ($\overline{\text{PFO}}$) goes low. If it goes above $V_{(\text{PFI})}$ plus about 12-mV hysteresis, the output returns to high. By connecting two external resistors, it is possible to supervise any voltages above $V_{(\text{PFI})}$. The sum of both resistors should be about 1 M Ω , to minimize power consumption and also to ensure that the current in the PFI pin can be neglected compared with the current through the resistor network. The tolerance of the external resistors should be not more than 1% to ensure minimal variation of sensed voltage.

If the power-fail comparator is unused, connect PFI to ground and leave $\overline{\text{PFO}}$ unconnected.

BATTON

Most often BATTON is used as a gate drive for an external pass transistor for high-current applications. In addition it can be also used as a logic output to indicate the battery switchover status. BATTON is high when V_{OUT} is connected to V_{BAT} .

BATTON can be directly connected to the gate of a PMOS transistor (see Figure 3). No current-limiting resistor is required. When using a PMOS transistor, it must be connected backwards from the traditional method (see Figure 3). This method orients the body diode from V_{DD} to V_{OUT} and prevents the backup battery from discharging through the FET when its gate is high.

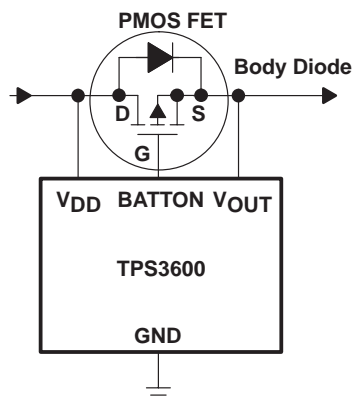

Figure 3. Driving an External MOSFET Transistor With BATTON

backup-battery switchover

In the event of a brownout or power failure, it may be necessary to keep a processor running. If a backup battery is installed at V_{BAT} , the devices automatically connect the processor to backup power when V_{DD} fails. In order to allow the backup battery (e.g., a 3.6-V lithium cell) to have a higher voltage than V_{DD} , this family of supervisors will not connect V_{BAT} to V_{OUT} when V_{BAT} is greater than V_{DD} . V_{BAT} only connects to V_{OUT} (through a 2- Ω switch) when V_{OUT} falls below $V_{(\text{SWN})}$ and V_{BAT} is greater than V_{DD} . When V_{DD} recovers, switchover is deferred either until V_{DD} crosses V_{BAT} , or when V_{DD} rises above the threshold $V_{(\text{SWP})}$. (See the timing diagram)

$V_{\text{DD}} > V_{\text{BAT}}$	$V_{\text{DD}} > V_{(\text{SW})}$	V_{OUT}
1	1	V_{DD}
1	0	V_{DD}
0	1	V_{DD}
0	0	V_{BAT}

detailed description (continued)

manual switchover (MSWITCH)

While operating in the normal mode from V_{DD} , the device can be manually forced to operate in the battery-backup mode by connecting MSWITCH to V_{DD} . The table below shows the different switchover modes.

	MSWITCH	STATUS
V_{DD} mode	GND	V_{DD} mode
	V_{DD}	Switch to battery-backup mode
Battery-backup mode	GND	Battery-backup mode
	V_{DD}	Battery-backup mode

If the manual switchover feature is not used, MSWITCH must be connected to ground.

watchdog

In a microprocessor- or DSP-based system, it is not only important to supervise the supply voltage, it is also important to ensure the correct program execution. The task of a watchdog is to ensure that the program is not stalled in an indefinite loop. The microprocessor, microcontroller, or the DSP have to toggle the watchdog input within typically 0.8 s to avoid a time-out from occurring. Either a low-to-high or a high-to-low transition resets the internal watchdog timer. If the input is unconnected the watchdog is disabled and will be retriggered internally.

saving current while using the watchdog

The watchdog input is internally driven low during the first 7/8 of the watchdog time-out period, then momentarily pulses high, resetting the watchdog counter. For minimum watchdog input current (minimum overall power consumption), leave WDI low for the majority of the watchdog time-out period, pulsing it low-high-low once within 7/8 of the watchdog time-out period to reset the watchdog timer. If instead, WDI is externally driven high for the majority of the time-out period, a current of e.g. $5\text{ V}/40\text{ k}\Omega \approx 125\text{ }\mu\text{A}$ can flow into WDI.

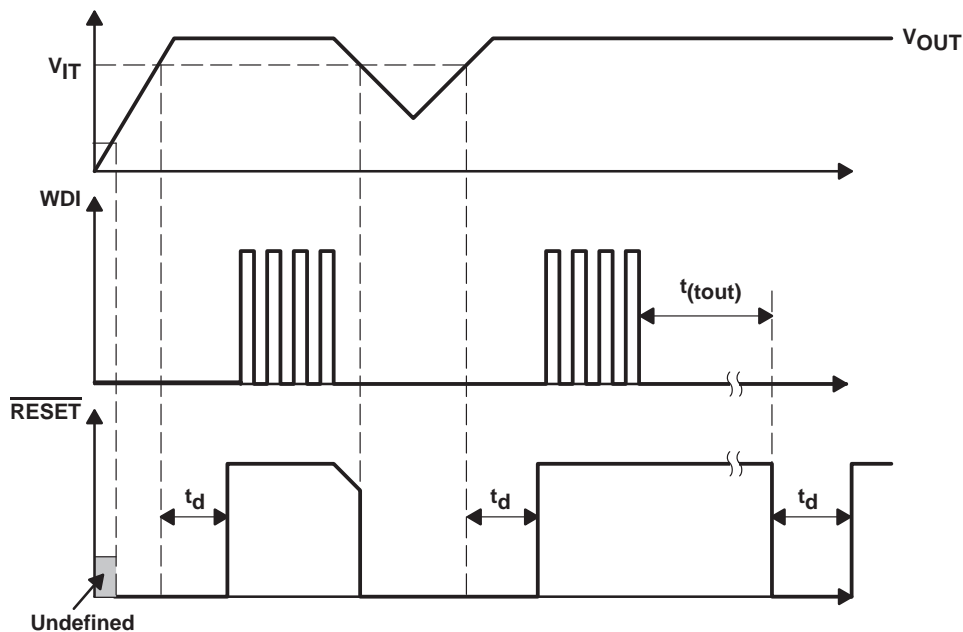

Figure 4. Watchdog Timing

TPS3600D20, TPS3600D25, TPS3600D33, TPS3600D50 BATTERY-BACKUP SUPERVISORS FOR LOW-POWER PROCESSORS

SLVS336B – DECEMBER 2000 – REVISED JANUARY 2007

absolute maximum ratings over operating free-air temperature (unless otherwise noted)†

Supply voltage: V_{DD} (see Note1)	7 V
MR and WDI	-0.3 V to ($V_{DD} + 0.3$ V)
All other pins (see Note 1)	-0.3 V to 7 V
Continuous output current at V_{OUT} : I_O	300 mA
All other pins, I_O	±10 mA
Continuous total power dissipation	See Dissipation Rating Table
Operating free-air temperature range, T_A	-40°C to 85°C
Storage temperature range, T_{stg}	-65°C to 150°C
Lead temperature soldering 1,6 mm (1/16 inch) from case for 10 seconds	260°C

† Stresses beyond those listed under “absolute maximum ratings” may cause permanent damage to the device. These are stress ratings only, and functional operation of the device at these or any other conditions beyond those indicated under “recommended operating conditions” is not implied. Exposure to absolute-maximum-rated conditions for extended periods may affect device reliability.

NOTE 1: All voltage values are with respect to GND. For reliable operation the device must not be operated at 7 V for more than $t = 1000h$ continuously.

DISSIPATION RATING TABLE

PACKAGE	$T_A < 25^\circ\text{C}$ POWER RATING	DERATING FACTOR ABOVE $T_A = 25^\circ\text{C}$	$T_A = 70^\circ\text{C}$ POWER RATING	$T_A = 85^\circ\text{C}$ POWER RATING
PW	700 mW	5.6 mW/°C	448 mW	364 mW

recommended operating conditions at specified temperature range

	MIN	MAX	UNIT
Supply voltage, V_{DD}	1.65	5.5	V
Battery supply voltage, V_{BAT}	1.5	5.5	V
Input voltage, V_I	0	$V_{OUT} + 0.3$	V
High-level input voltage, V_{IH}	$0.7 \times V_{OUT}$		V
Low-level input voltage, all other pins, V_{IL}		$0.3 \times V_{OUT}$	V
Continuous output current at V_{OUT} , I_O		200	mA
Input transition rise and fall rate at WDI, MSWITCH, $\Delta t/\Delta V$		100	ns/V
Slew rate at V_{DD} or V_{BAT}		34	mV/μs
Operating free-air temperature range, T_A	-40	85	°C

TPS3600D20, TPS3600D25, TPS3600D33, TPS3600D50 BATTERY-BACKUP SUPERVISORS FOR LOW-POWER PROCESSORS

SLVS336B – DECEMBER 2000 – REVISED JANUARY 2007

electrical characteristics over recommended operating conditions (unless otherwise noted)

PARAMETER		TEST CONDITIONS	MIN	TYP	MAX	UNIT	
V _{OH}	High-level output voltage	RESET, BATTOK, BATTON	V _{OUT} = 2.0 V, I _{OH} = -400 μA	V _{OUT} - 0.2 V		V	
			V _{OUT} = 3.3 V, I _{OH} = -2 mA	V _{OUT} - 0.4 V			
			V _{OUT} = 5.0 V, I _{OH} = -3 mA	V _{OUT} - 0.4 V			
	PFO		V _{OUT} = 1.8 V, I _{OH} = -20 μA	V _{OUT} - 0.3 V			
			V _{OUT} = 3.3 V, I _{OH} = -80 μA	V _{OUT} - 0.4 V			
			V _{OUT} = 5.0 V, I _{OH} = -120 μA	V _{OUT} - 0.4 V			
	CEOUT Enable mode CEIN = V _{OUT}		V _{OUT} = 2.0 V, I _{OH} = -1 mA	V _{OUT} - 0.2 V			
			V _{OUT} = 3.3 V, I _{OH} = -2 mA	V _{OUT} - 0.3 V			
			V _{OUT} = 5.0 V, I _{OH} = -5 mA	V _{OUT} - 0.3 V			
	CEOUT Disable mode		V _{OUT} = 3.3 V, I _{OH} = -0.5 mA	V _{OUT} - 0.4 V			
V _{OL}	Low-level output voltage	RESET, PFO, BATTOK	V _{OUT} = 2.0 V, I _{OL} = 400 μA	0.2		V	
			V _{OUT} = 3.3 V, I _{OL} = 2 mA	0.4			
			V _{OUT} = 5.0 V, I _{OL} = 3 mA	0.4			
	BATTON		V _{OUT} = 1.8 V, I _{OL} = 500 μA	0.2			
			V _{OUT} = 3.3 V, I _{OL} = 3 mA	0.4			
			V _{OUT} = 5.0 V, I _{OL} = 5 mA	0.4			
	CEOUT Enable mode CEIN = 0 V		V _{OUT} = 2.0 V, I _{OL} = 1 mA	0.2			
			V _{OUT} = 3.3 V, I _{OL} = 2 mA	0.3			
			V _{OUT} = 5.0 V, I _{OL} = 5 mA	0.3			
	V _{res}	Power-up reset voltage (see Note 2)	V _{BAT} > 1.1 V OR V _{DD} > 1.4 V, I _{OL} = 20 μA	0.4			V
V _{OUT}	Normal mode	I _O = 5 mA, V _{DD} = 1.8 V	V _{DD} - 50 mV		V		
		I _O = 75 mA, V _{DD} = 3.3 V	V _{DD} - 150 mV				
		I _O = 150 mA, V _{DD} = 5 V	V _{DD} - 250 mV				
	Battery-backup mode	I _O = 4 mA, V _{BAT} = 1.5 V	V _{BAT} - 50 mV				
		I _O = 75 mA, V _{BAT} = 3.3 V	V _{BAT} - 150 mV				
r _{ds(on)}	V _{DD} to V _{OUT} on-resistance	V _{DD} = 3.3 V	1	2	Ω		
	V _{BAT} to V _{OUT} on-resistance	V _{BAT} = 3.3 V	1	2			
V _{IT}	Negative-going input threshold voltage (see Notes 3 and 4)	TPS3600x20	T _A = -40°C to 85°C	1.74	1.78	1.82	V
		TPS3600x25		2.17	2.22	2.27	
		TPS3600x30		2.57	2.63	2.69	
		TPS3600x33		2.87	2.93	2.99	
		TPS3600x50		4.31	4.40	4.49	
		PFI		1.13	1.15	1.17	
V(PFI)							
V(BOK)		TPS3600Dxx	V _{IT} + 5.8%	V _{IT} + 7.1%	V _{IT} + 8.3%		
V(SWN)	Battery switch threshold voltage negative-going V _{OUT}		V _{IT} + 1%	V _{IT} + 2%	V _{IT} + 3.2%	V	

- NOTES: 2. The lowest supply voltage at which RESET becomes active. t_r(V_{DD}) ≥ 15 μs/V.
3. To ensure best stability of the threshold voltage, a bypass capacitor (ceramic, 0.1 μF) should be placed near the supply terminal.
4. Voltage is sensed at V_{OUT}

TPS3600D20, TPS3600D25, TPS3600D33, TPS3600D50 BATTERY-BACKUP SUPERVISORS FOR LOW-POWER PROCESSORS

SLVS336B – DECEMBER 2000 – REVISED JANUARY 2007

electrical characteristics over recommended operating conditions (unless otherwise noted) (continued)

PARAMETER		TEST CONDITIONS	MIN	TYP	MAX	UNIT
V _{hys}	Hysteresis	V _{IT}	1.65 V < V _{IT} < 2.5 V		20	mV
			2.5 V < V _{IT} < 3.5 V		40	
			3.5 V < V _{IT} < 5.5 V		50	
	BATTOK	1.65 V < V _(BOK) < 2.5 V		30		
		2.5 V < V _(BOK) < 3.5 V		60		
		3.5 V < V _(BOK) < 5.5 V		100		
	PFI			12		
	V _(BSW)	V _{DD} = 1.8 V		66		
	V _(SWN)	1.65 V < V _(SWN) < 2.5 V		85		
2.5 V < V _(SWN) < 3.5 V		100				
3.5 V < V _(SWN) < 5.5 V		110				
I _{IH}	High-level input current	WDI (see Note 5)	WDI = V _{DD} = 5 V		150	μA
		MR	MR = 0.7 × V _{DD} , V _{DD} = 5 V		-33 -76	
I _{IL}	Low-level input current	WDI (see Note 5)	WDI = 0 V, V _{DD} = 5 V		-150	μA
		MR	MR = 0 V, V _{DD} = 5 V		-110 -255	
I _I	Input current	PFI, MSWITCH	V _I < V _{DD}		-25 25	nA
I _{OS}	Short-circuit current	PFO	PFO = 0 V, V _{DD} = 1.8 V		-0.3	mA
			PFO = 0 V, V _{DD} = 3.3 V		-1.1	
			PFO = 0 V, V _{DD} = 5 V		-2.4	
I _{DD}	V _{DD} supply current		V _{OUT} = V _{DD}		40	μA
			V _{OUT} = V _{BAT}		8	
I _(BAT)	V _{BAT} supply current		V _{OUT} = V _{DD}		-0.1 0.1	μA
			V _{OUT} = V _{BAT}		40	
I _{lkg}	CEIN leakage current		Disable mode, V _I < V _{DD}		±1	μA
C _i	Input capacitance		V _I = 0 V to 5.0 V		5	pF

NOTE 5: For details on how to optimize current consumption when using WDI, see the detailed description section.

TPS3600D20, TPS3600D25, TPS3600D33, TPS3600D50 BATTERY-BACKUP SUPERVISORS FOR LOW-POWER PROCESSORS

SLVS336B – DECEMBER 2000 – REVISED JANUARY 2007

timing requirements at $R_L = 1\text{ M}\Omega$, $C_L = 50\text{ pF}$, $T_A = -40^\circ\text{C}$ to 85°C

PARAMETER		TEST CONDITIONS	MIN	TYP	MAX	UNIT
t_w	Pulse width	V_{DD}	$V_{IH} = V_{IT} + 0.2\text{ V}$, $V_{IL} = V_{IT} - 0.2\text{ V}$	5	1	μs
		$\overline{\text{MR}}$	$V_{DD} > V_{IT} + 0.2\text{ V}$, $V_{IL} = 0.3 \times V_{DD}$, $V_{IH} = 0.7 \times V_{DD}$	100		ns
		$\overline{\text{WDI}}$				

switching characteristics at $R_L = 1\text{ M}\Omega$, $C_L = 50\text{ pF}$, $T_A = -40^\circ\text{C}$ to 85°C

PARAMETER		TEST CONDITIONS	MIN	TYP	MAX	UNIT
t_d	Delay time	$V_{DD} \geq V_{IT} + 0.2\text{ V}$, $\overline{\text{MR}} \geq 0.7 \times V_{DD}$, See timing diagram	60	100	140	ms
$t_{(\text{tout})}$	Watchdog time-out	$V_{DD} > V_{IT} + 0.2\text{ V}$, See timing diagram	0.48	0.8	1.12	s
t_{PLH}	Propagation (delay) time, low-to-high-level output	50% $\overline{\text{RESET}}$ to 50% $\overline{\text{CEOUT}}$		15		μs
t_{PHL}	Propagation (delay) time, high-to-low-level output	V_{DD} to $\overline{\text{RESET}}$	$V_{IL} = V_{IT} - 0.2\text{ V}$, $V_{IH} = V_{IT} + 0.2\text{ V}$	2	5	μs
		PFI to $\overline{\text{PFO}}$	$V_{IL} = V(\text{PFI}) - 0.2\text{ V}$, $V_{IH} = V(\text{PFI}) + 0.2\text{ V}$	3	5	μs
		$\overline{\text{MR}}$ to $\overline{\text{RESET}}$	$V_{DD} \geq V_{IT} + 0.2\text{ V}$, $V_{IL} = 0.3 \times V_{DD}$, $V_{IH} = 0.7 \times V_{DD}$	0.1	1	μs
		50% $\overline{\text{CEIN}}$ to 50% $\overline{\text{CEOUT}}$ $C_L = 50\text{ pF}$ only (see Note 6)	$V_{DD} = 1.8\text{ V}$	5	15	ns
			$V_{DD} = 3.3\text{ V}$	1.6	5	ns
	$V_{DD} = 5\text{ V}$	1	3	ns		
	Transition time	V_{DD} to $\overline{\text{BATTON}}$			3	μs

NOTE 6: Ensured by design.

TYPICAL CHARACTERISTICS

Table of Graphs

			FIGURE
$r_{\text{DS(on)}}$	Static Drain-source on-state resistance V_{DD} to V_{OUT}	vs Output current	5
	Static Drain-source on-state resistance V_{BAT} to V_{OUT}		6
	Static Drain-source on-state resistance		7
I_{DD}	Supply current	vs Supply voltage	8, 9
V_{IT}	Normalized threshold voltage	vs Free-air temperature	10
V_{OH}	High-level output voltage at $\overline{\text{RESET}}$	vs High-level output current	11, 12
	High-level output voltage at $\overline{\text{PFO}}$		13, 14
	High-level output voltage at $\overline{\text{CEOUT}}$		15, 16, 17, 18
V_{OL}	Low-level output voltage at $\overline{\text{RESET}}$	vs Low-level output current	19, 20
	Low-level output voltage at $\overline{\text{CEOUT}}$		21, 22
	Low-level output voltage at $\overline{\text{BATTON}}$		23, 24
$t_{\text{p(min)}}$	Minimum Pulse Duration at V_{DD}	vs Threshold voltage overdrive at V_{DD}	25
	Minimum Pulse Duration at PFI	vs Threshold voltage overdrive at PFI	26

TPS3600D20, TPS3600D25, TPS3600D33, TPS3600D50 BATTERY-BACKUP SUPERVISORS FOR LOW-POWER PROCESSORS

SLVS336B – DECEMBER 2000 – REVISED JANUARY 2007

TYPICAL CHARACTERISTICS

STATIC DRAIN SOURCE ON-STATE RESISTANCE
(V_{DD} TO V_{OUT})
vs
OUTPUT CURRENT

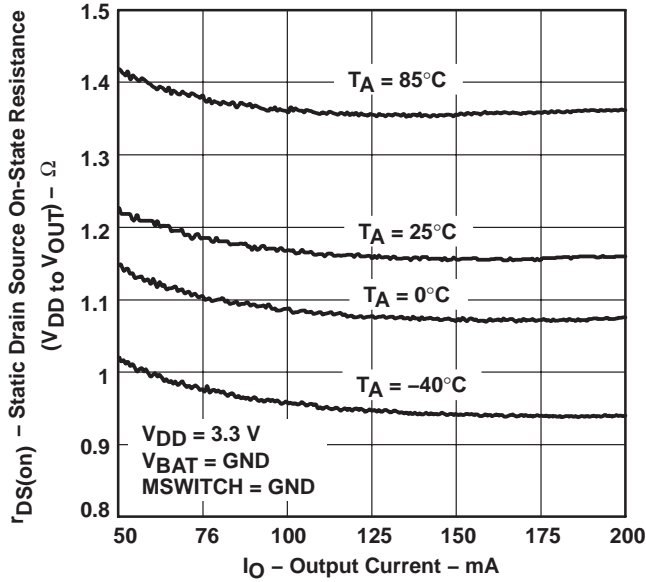

Figure 5

STATIC DRAIN SOURCE ON-STATE RESISTANCE
(V_{BAT} TO V_{OUT})
vs
OUTPUT CURRENT

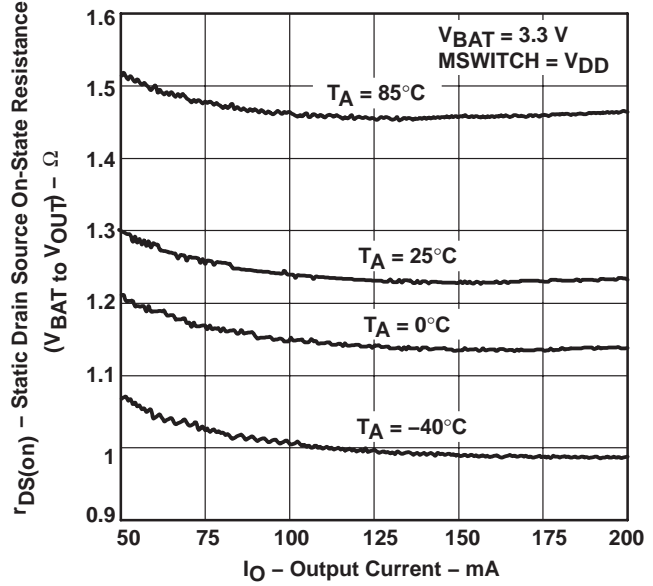

Figure 6

STATIC DRAIN SOURCE ON-STATE RESISTANCE
(CE_{IN} TO CE_{OUT})
vs
CHIP-ENABLE INPUT VOLTAGE

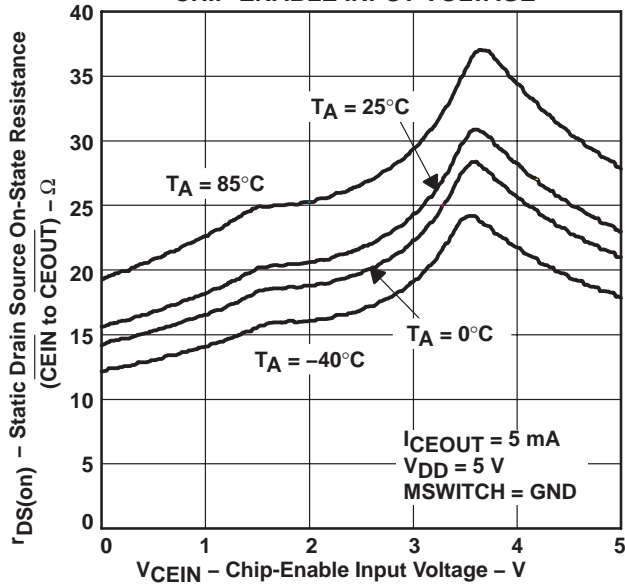

Figure 7

SUPPLY CURRENT
vs
SUPPLY VOLTAGE

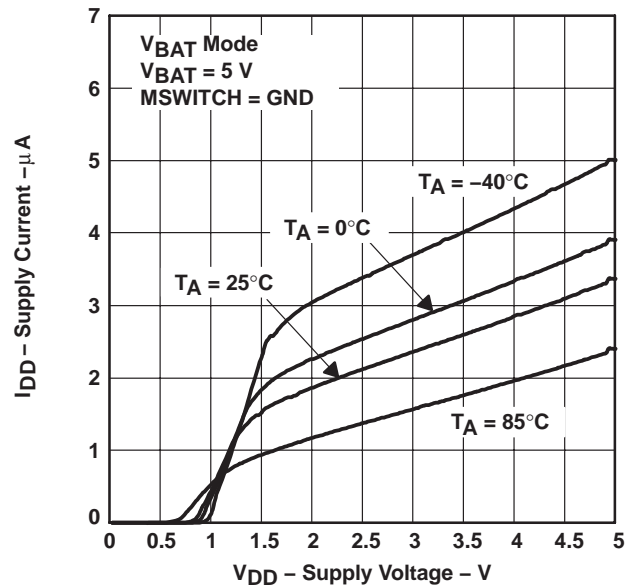

Figure 8

TYPICAL CHARACTERISTICS

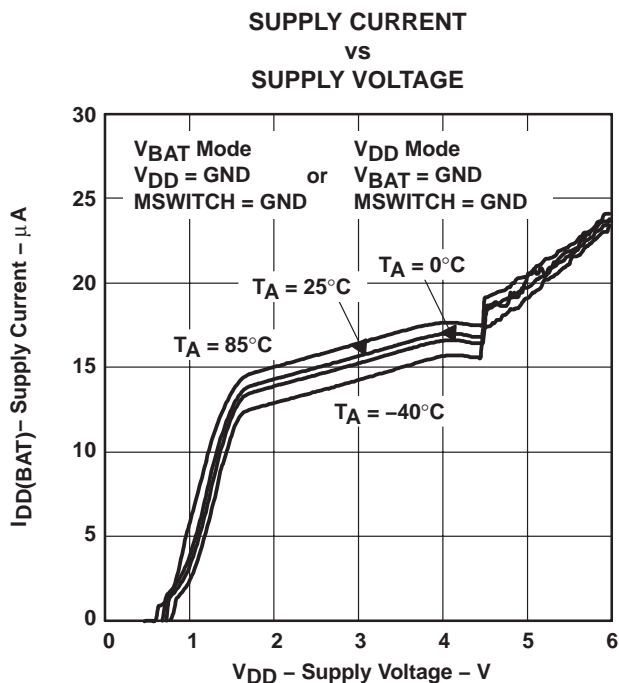

Figure 9

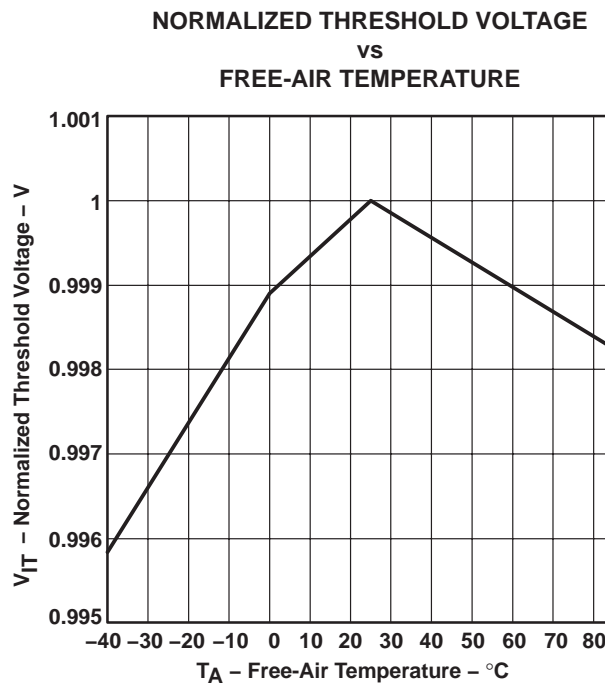

Figure 10

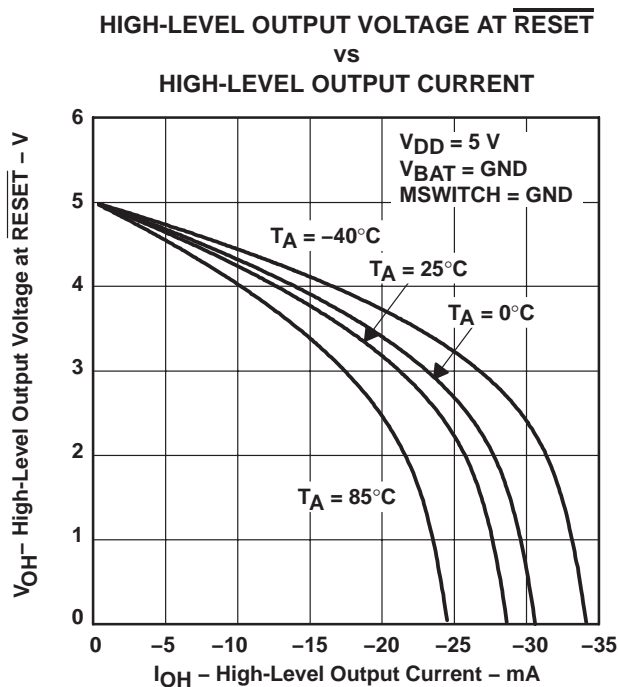

Figure 11

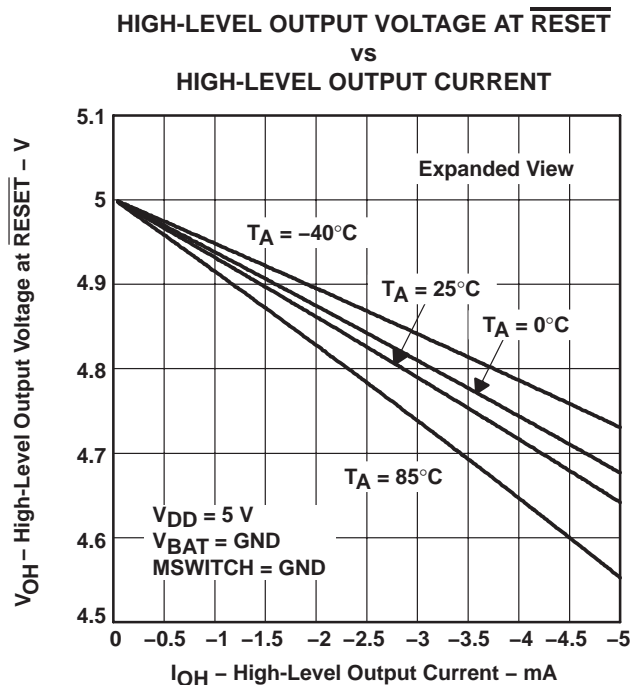
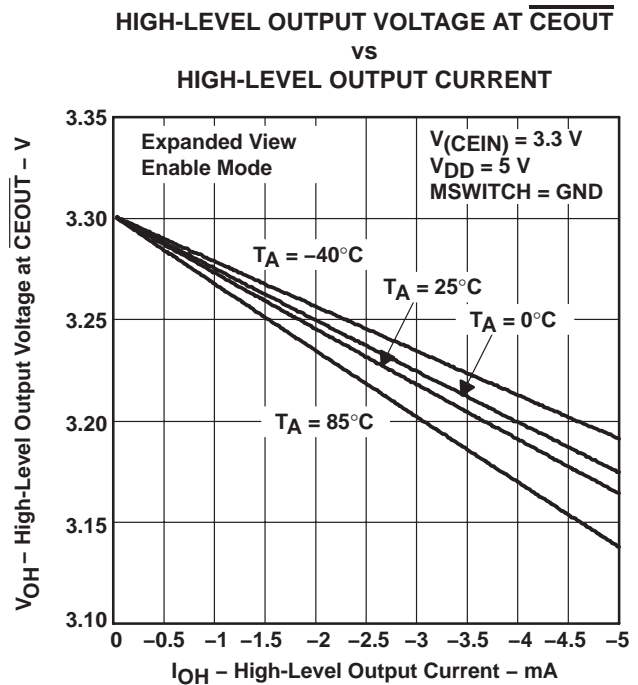
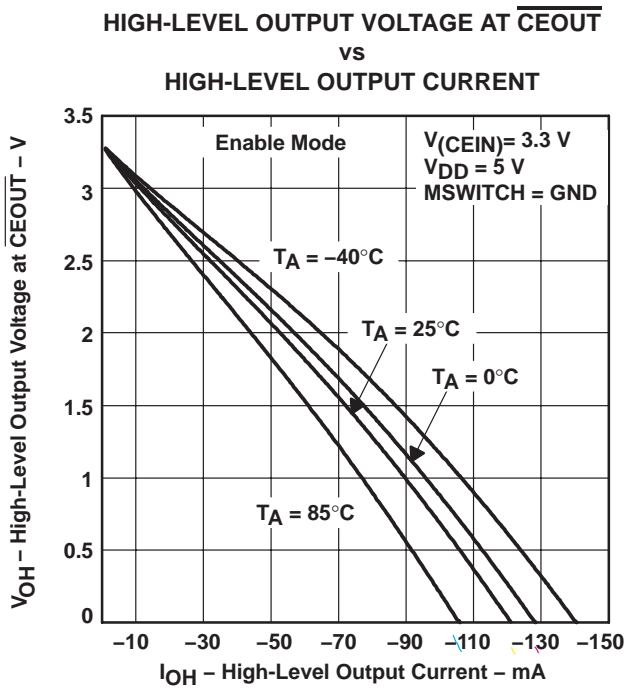
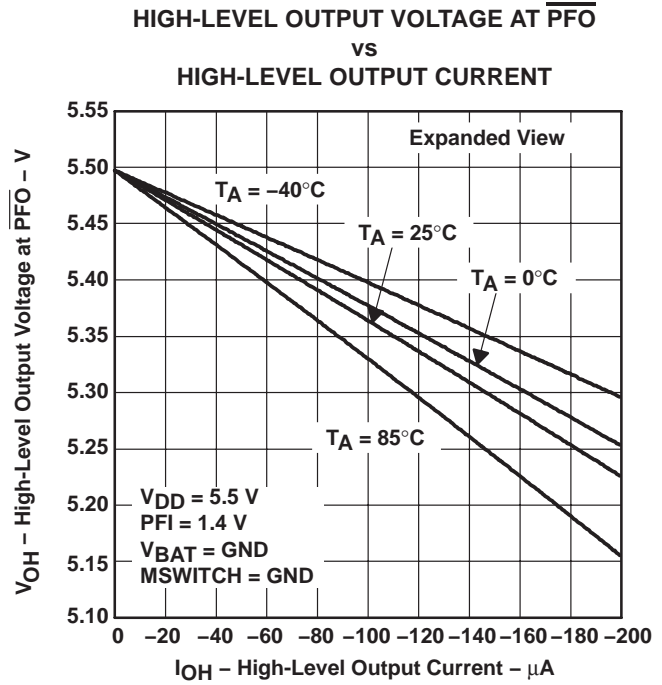
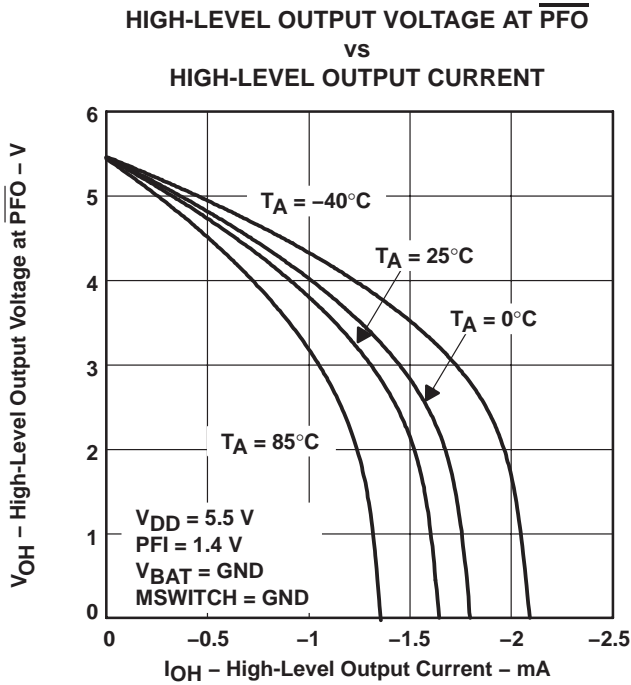

Figure 12

TPS3600D20, TPS3600D25, TPS3600D33, TPS3600D50 BATTERY-BACKUP SUPERVISORS FOR LOW-POWER PROCESSORS

SLVS336B – DECEMBER 2000 – REVISED JANUARY 2007

TYPICAL CHARACTERISTICS



TYPICAL CHARACTERISTICS

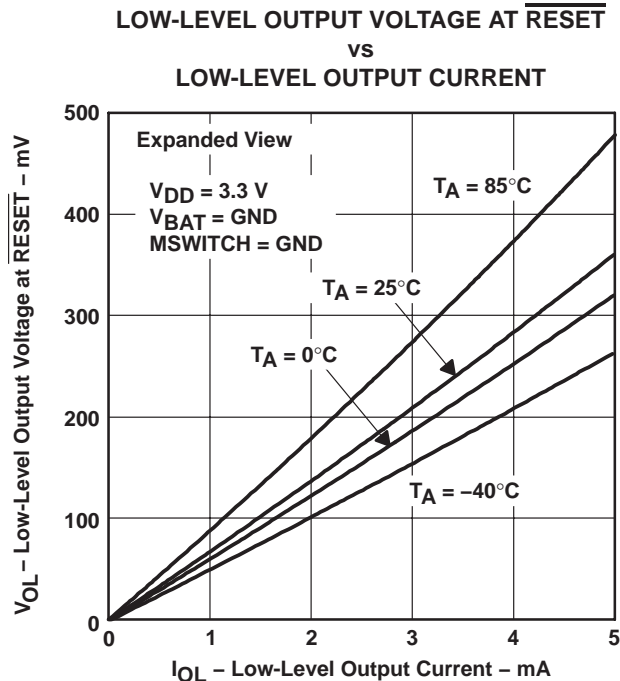
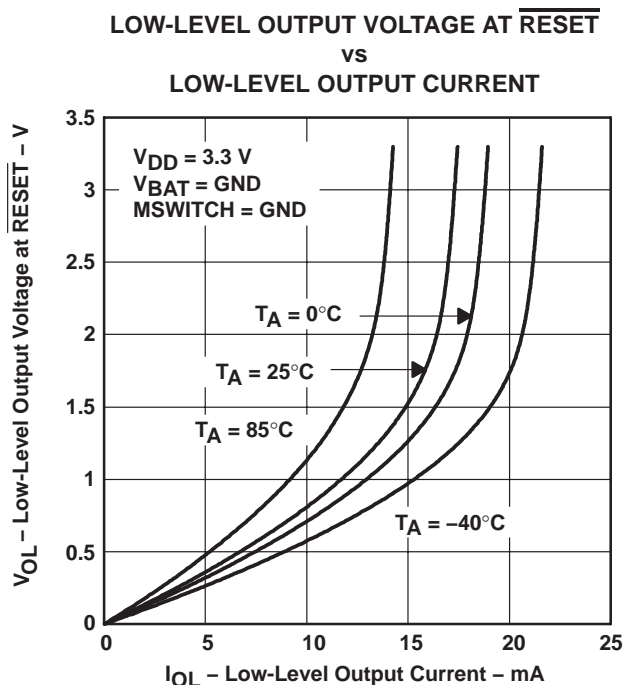
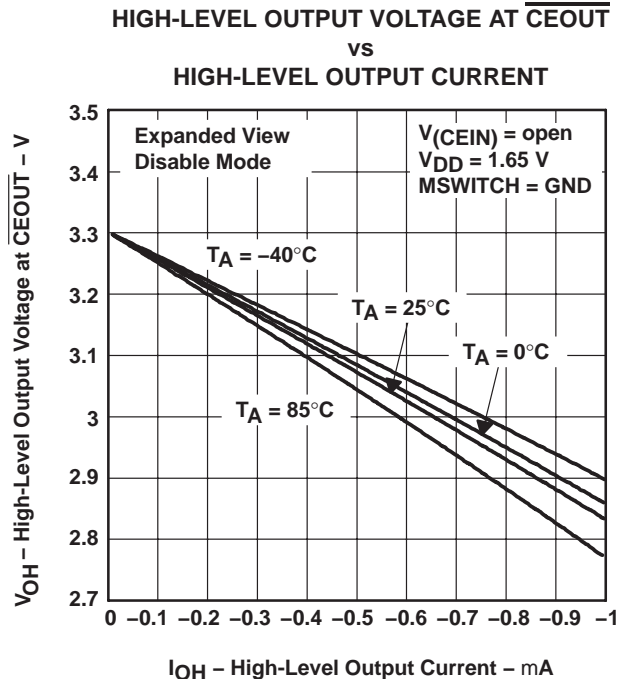
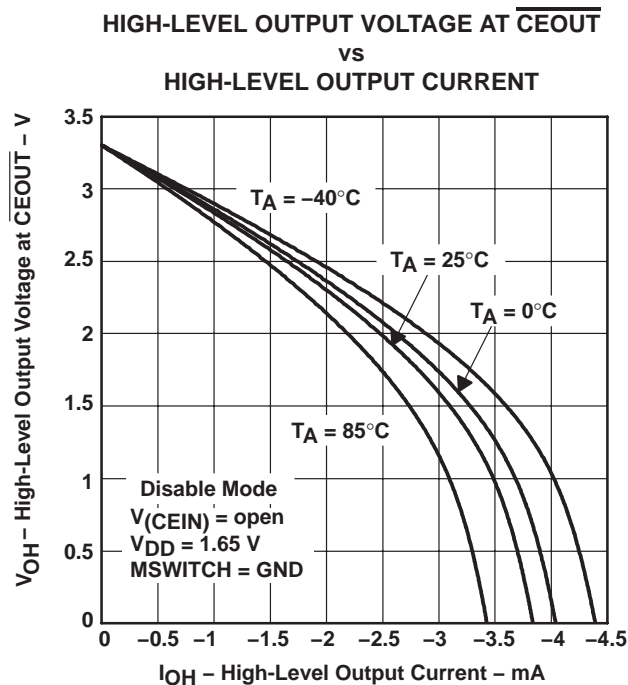

TPS3600D20, TPS3600D25, TPS3600D33, TPS3600D50 BATTERY-BACKUP SUPERVISORS FOR LOW-POWER PROCESSORS

SLVS336B – DECEMBER 2000 – REVISED JANUARY 2007

TYPICAL CHARACTERISTICS

LOW-LEVEL OUTPUT VOLTAGE AT \overline{CEOUT}
vs
LOW-LEVEL OUTPUT CURRENT

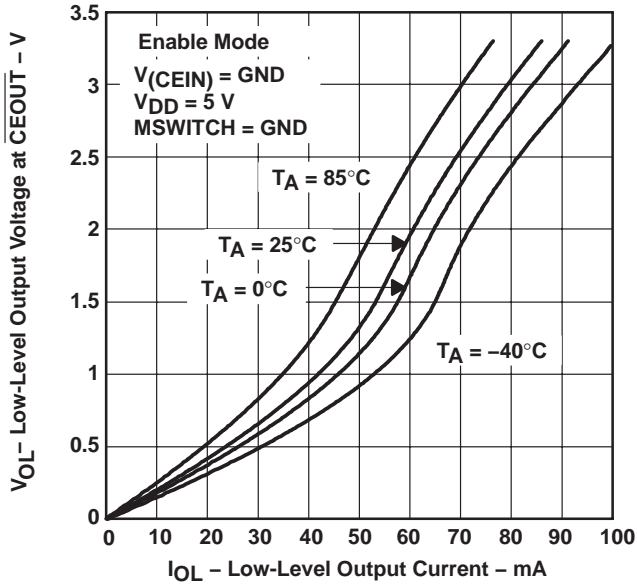

Figure 21

LOW-LEVEL OUTPUT VOLTAGE AT \overline{CEOUT}
vs
LOW-LEVEL OUTPUT CURRENT

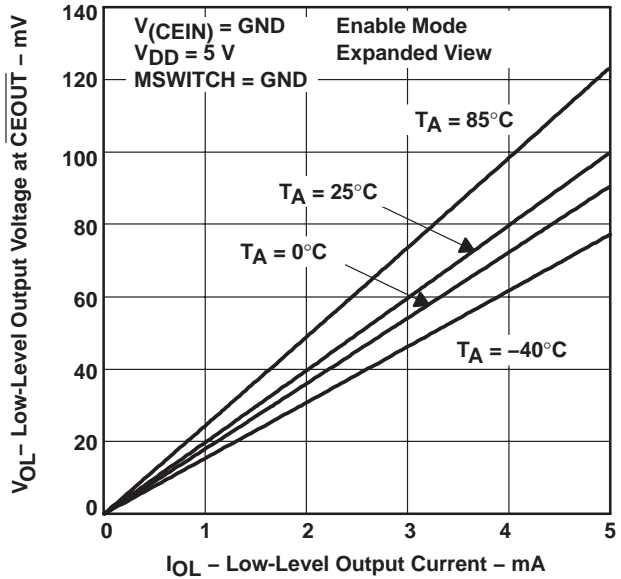

Figure 22

LOW-LEVEL OUTPUT VOLTAGE AT \overline{BATTON}
vs
LOW-LEVEL OUTPUT CURRENT

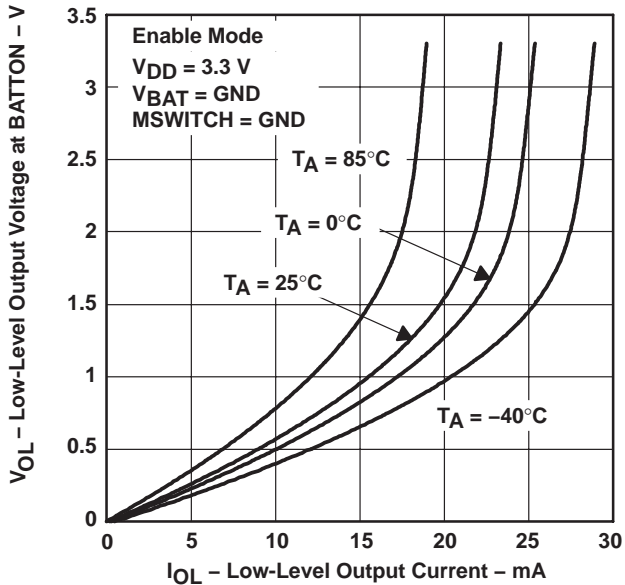

Figure 23

LOW-LEVEL OUTPUT VOLTAGE AT \overline{BATTON}
vs
LOW-LEVEL OUTPUT CURRENT

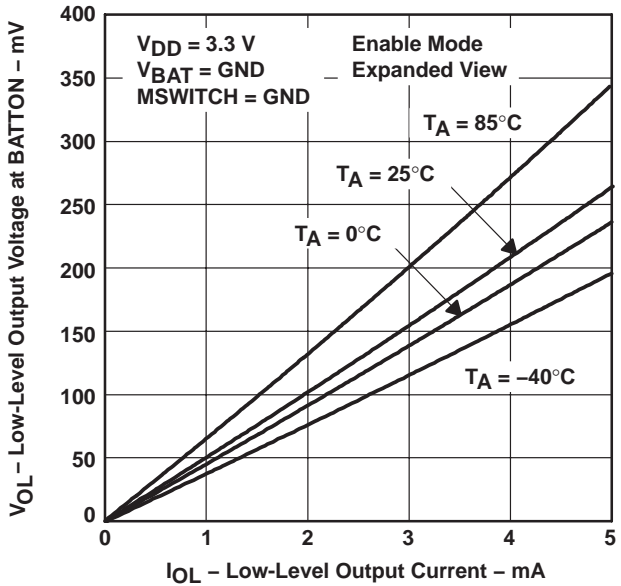

Figure 24

TYPICAL CHARACTERISTICS

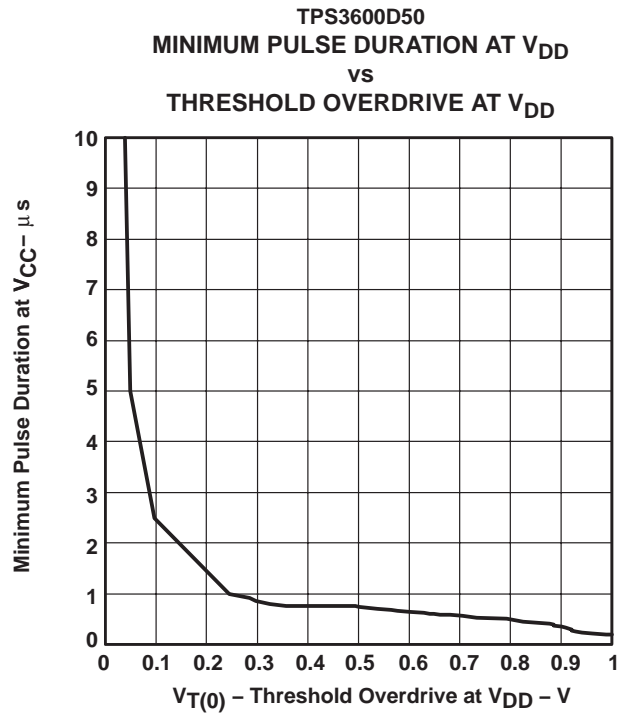

Figure 25

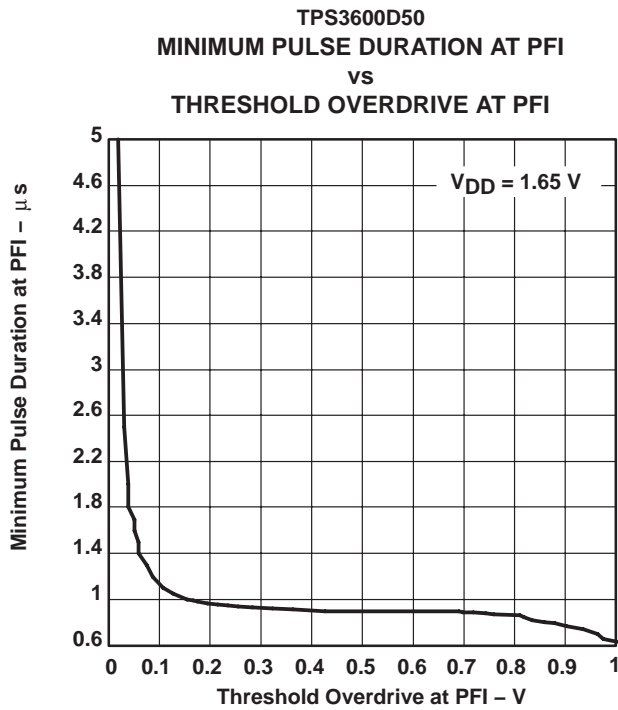

Figure 26

PACKAGING INFORMATION

Orderable Device	Status (1)	Package Type	Package Drawing	Pins	Package Qty	Eco Plan (2)	Lead finish/ Ball material (6)	MSL Peak Temp (3)	Op Temp (°C)	Device Marking (4/5)	Samples
TPS3600D20PW	OBSOLETE	TSSOP	PW	14		TBD	Call TI	Call TI	-40 to 85	3600D20	
TPS3600D20PWR	ACTIVE	TSSOP	PW	14	2000	RoHS & Green	NIPDAU	Level-1-260C-UNLIM	-40 to 85	3600D20	Samples
TPS3600D25PW	ACTIVE	TSSOP	PW	14	90	RoHS & Green	NIPDAU	Level-1-260C-UNLIM	-40 to 85	3600D25	Samples
TPS3600D33PW	ACTIVE	TSSOP	PW	14	90	RoHS & Green	NIPDAU	Level-1-260C-UNLIM	-40 to 85	3600D33	Samples
TPS3600D33PWR	ACTIVE	TSSOP	PW	14	2000	RoHS & Green	NIPDAU	Level-1-260C-UNLIM	-40 to 85	3600D33	Samples
TPS3600D50PW	ACTIVE	TSSOP	PW	14	90	RoHS & Green	NIPDAU	Level-1-260C-UNLIM	-40 to 85	3600D50	Samples

(1) The marketing status values are defined as follows:

ACTIVE: Product device recommended for new designs.

LIFEBUY: TI has announced that the device will be discontinued, and a lifetime-buy period is in effect.

NRND: Not recommended for new designs. Device is in production to support existing customers, but TI does not recommend using this part in a new design.

PREVIEW: Device has been announced but is not in production. Samples may or may not be available.

OBSOLETE: TI has discontinued the production of the device.

(2) **RoHS:** TI defines "RoHS" to mean semiconductor products that are compliant with the current EU RoHS requirements for all 10 RoHS substances, including the requirement that RoHS substance do not exceed 0.1% by weight in homogeneous materials. Where designed to be soldered at high temperatures, "RoHS" products are suitable for use in specified lead-free processes. TI may reference these types of products as "Pb-Free".

RoHS Exempt: TI defines "RoHS Exempt" to mean products that contain lead but are compliant with EU RoHS pursuant to a specific EU RoHS exemption.

Green: TI defines "Green" to mean the content of Chlorine (Cl) and Bromine (Br) based flame retardants meet JS709B low halogen requirements of <=1000ppm threshold. Antimony trioxide based flame retardants must also meet the <=1000ppm threshold requirement.

(3) MSL, Peak Temp. - The Moisture Sensitivity Level rating according to the JEDEC industry standard classifications, and peak solder temperature.

(4) There may be additional marking, which relates to the logo, the lot trace code information, or the environmental category on the device.

(5) Multiple Device Markings will be inside parentheses. Only one Device Marking contained in parentheses and separated by a "~" will appear on a device. If a line is indented then it is a continuation of the previous line and the two combined represent the entire Device Marking for that device.

(6) Lead finish/Ball material - Orderable Devices may have multiple material finish options. Finish options are separated by a vertical ruled line. Lead finish/Ball material values may wrap to two lines if the finish value exceeds the maximum column width.

Important Information and Disclaimer: The information provided on this page represents TI's knowledge and belief as of the date that it is provided. TI bases its knowledge and belief on information provided by third parties, and makes no representation or warranty as to the accuracy of such information. Efforts are underway to better integrate information from third parties. TI has taken and continues to take reasonable steps to provide representative and accurate information but may not have conducted destructive testing or chemical analysis on incoming materials and chemicals. TI and TI suppliers consider certain information to be proprietary, and thus CAS numbers and other limited information may not be available for release.

In no event shall TI's liability arising out of such information exceed the total purchase price of the TI part(s) at issue in this document sold by TI to Customer on an annual basis.

TAPE AND REEL INFORMATION

QUADRANT ASSIGNMENTS FOR PIN 1 ORIENTATION IN TAPE

*All dimensions are nominal

Device	Package Type	Package Drawing	Pins	SPQ	Reel Diameter (mm)	Reel Width W1 (mm)	A0 (mm)	B0 (mm)	K0 (mm)	P1 (mm)	W (mm)	Pin1 Quadrant
TPS3600D20PWR	TSSOP	PW	14	2000	330.0	12.4	6.65	5.55	1.6	8.0	12.0	Q1
TPS3600D33PWR	TSSOP	PW	14	2000	330.0	12.4	6.9	5.6	1.6	8.0	12.0	Q1

TAPE AND REEL BOX DIMENSIONS

*All dimensions are nominal

Device	Package Type	Package Drawing	Pins	SPQ	Length (mm)	Width (mm)	Height (mm)
TPS3600D20PWR	TSSOP	PW	14	2000	367.0	367.0	38.0
TPS3600D33PWR	TSSOP	PW	14	2000	350.0	350.0	43.0

TUBE

*All dimensions are nominal

Device	Package Name	Package Type	Pins	SPQ	L (mm)	W (mm)	T (μm)	B (mm)
TPS3600D25PW	PW	TSSOP	14	90	530	10.2	3600	3.5
TPS3600D33PW	PW	TSSOP	14	90	530	10.2	3600	3.5
TPS3600D50PW	PW	TSSOP	14	90	530	10.2	3600	3.5



4220202/B 12/2023

NOTES:

1. All linear dimensions are in millimeters. Any dimensions in parenthesis are for reference only. Dimensioning and tolerancing per ASME Y14.5M.
2. This drawing is subject to change without notice.
3. This dimension does not include mold flash, protrusions, or gate burrs. Mold flash, protrusions, or gate burrs shall not exceed 0.15 mm per side.
4. This dimension does not include interlead flash. Interlead flash shall not exceed 0.25 mm per side.
5. Reference JEDEC registration MO-153.

EXAMPLE BOARD LAYOUT

PW0014A

TSSOP - 1.2 mm max height

SMALL OUTLINE PACKAGE



LAND PATTERN EXAMPLE
EXPOSED METAL SHOWN
SCALE: 10X



4220202/B 12/2023

NOTES: (continued)

- 6. Publication IPC-7351 may have alternate designs.
- 7. Solder mask tolerances between and around signal pads can vary based on board fabrication site.

EXAMPLE STENCIL DESIGN

PW0014A

TSSOP - 1.2 mm max height

SMALL OUTLINE PACKAGE



SOLDER PASTE EXAMPLE
BASED ON 0.125 mm THICK STENCIL
SCALE: 10X

4220202/B 12/2023

NOTES: (continued)

8. Laser cutting apertures with trapezoidal walls and rounded corners may offer better paste release. IPC-7525 may have alternate design recommendations.
9. Board assembly site may have different recommendations for stencil design.

IMPORTANT NOTICE AND DISCLAIMER

TI PROVIDES TECHNICAL AND RELIABILITY DATA (INCLUDING DATA SHEETS), DESIGN RESOURCES (INCLUDING REFERENCE DESIGNS), APPLICATION OR OTHER DESIGN ADVICE, WEB TOOLS, SAFETY INFORMATION, AND OTHER RESOURCES "AS IS" AND WITH ALL FAULTS, AND DISCLAIMS ALL WARRANTIES, EXPRESS AND IMPLIED, INCLUDING WITHOUT LIMITATION ANY IMPLIED WARRANTIES OF MERCHANTABILITY, FITNESS FOR A PARTICULAR PURPOSE OR NON-INFRINGEMENT OF THIRD PARTY INTELLECTUAL PROPERTY RIGHTS.

These resources are intended for skilled developers designing with TI products. You are solely responsible for (1) selecting the appropriate TI products for your application, (2) designing, validating and testing your application, and (3) ensuring your application meets applicable standards, and any other safety, security, regulatory or other requirements.

These resources are subject to change without notice. TI grants you permission to use these resources only for development of an application that uses the TI products described in the resource. Other reproduction and display of these resources is prohibited. No license is granted to any other TI intellectual property right or to any third party intellectual property right. TI disclaims responsibility for, and you will fully indemnify TI and its representatives against, any claims, damages, costs, losses, and liabilities arising out of your use of these resources.

TI's products are provided subject to [TI's Terms of Sale](#) or other applicable terms available either on [ti.com](https://www.ti.com) or provided in conjunction with such TI products. TI's provision of these resources does not expand or otherwise alter TI's applicable warranties or warranty disclaimers for TI products.

TI objects to and rejects any additional or different terms you may have proposed.

Mailing Address: Texas Instruments, Post Office Box 655303, Dallas, Texas 75265
Copyright © 2024, Texas Instruments Incorporated