

NCP1602

Enhanced, High-Efficiency Power Factor Controller

The 6-pin PFC controller NCP1602 is designed to drive PFC boost stages. It is based on an innovative Valley Synchronized Frequency Fold-back (VSFF) method. In this mode, the circuit classically operates in Critical conduction Mode (CrM) when $V_{control}$ voltage exceeds a programmable value $V_{ctrl,FF}$. When $V_{control}$ is below this preset level $V_{ctrl,FF}$, the NCP1602 (versions [B**] and [D**]) linearly decays the frequency down to about 30 kHz until $V_{control}$ reaches the SKIP mode threshold. VSFF maximizes the efficiency at both nominal and light load. In particular, the stand-by losses are reduced to a minimum. Like in FCCrM controllers, internal circuitry allows near-unity power factor even when the switching frequency is reduced. Housed in a TSOP6 package, the circuit also incorporates the features necessary for robust and compact PFC stages, with few external components.

General Features

- Near-Unity Power Factor
- Critical Conduction Mode (CrM)
- Valley Synchronized Frequency Fold-back (VSFF): Low Frequency Operation is Forced at Low Current Levels
- Works With or Without a Transformer w/ ZCD Winding (simple inductor)
- On-time Modulation to Maintain a Proper Current Shaping in VSFF Mode
- Skip Mode at Very Low Load Current (versions [B**] and [D**])
- Fast Line / Load Transient Compensation (*D*ynamic *R*esponse *E*nhancer)
- Valley Turn-on
- High Drive Capability: -500 mA / +800 mA
- V_{CC} Range: from 9.5 V to 30 V
- Low Start-up Consumption for:
 - [**C] & [**D] Versions: Low V_{CC} Start-up level (10.5 V)
 - [**A] & [**B] Versions: High V_{CC} Start-up level (17.0 V)
- Line Range Detection for Reduced Crossover Frequency Spread
- This is a Pb-Free Device

Safety Features

- Thermal Shutdown
- Non-latching, Over-Voltage Protection
- Second Over-Voltage Protection
- Brown-Out Detection
- Soft-Start for Smooth Start-up Operation ([**C] & [**D] Versions)
- Over Current Limitation
- Disable Protection if the Feedback Pin is Not Connected
- Low Duty-Cycle Operation if the Bypass Diode is Shorted
- Open Ground Pin Fault Monitoring



ON Semiconductor®

www.onsemi.com



TSOP-6
SN SUFFIX
CASE 318G

MARKING DIAGRAM

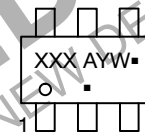

XXX = Specific Device Code
A = Assembly Location
Y = Year
W = Work Week
▪ = Pb-Free Package

(Note: Microdot may be in either location)

PIN CONNECTIONS

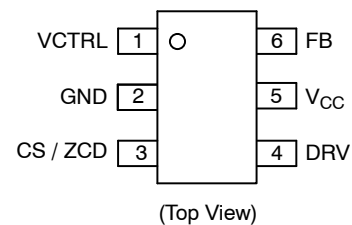

ORDERING INFORMATION

See detailed ordering, marking and shipping information in the package dimensions section on page 2 of this data sheet.

Typical Applications

- PC Power Supplies
- Lighting Ballasts (LED, Fluorescent)
- Flat TV
- All Off Line Appliances Requiring Power Factor Correction

NCP1602

DEVICE ORDERING INFORMATION

Operating Part Number (OPN)	L ₁ , L ₂ , L ₃ Option	Marking	Package Type	Shipping
NCP1602ABASNT1G	ABA	ABA	TSOP-6 (Pb-Free)	3000 / Tape & Reel
NCP1602ACCSNT1G	ACC	A6C		
NCP1602AEASNT1G	AEA	AEA		
NCP1602AFCSNT1G	AFC	AFC		
NCP1602BEASNT1G	BEA	2EA		
NCP1602DCCSNT1G	DCC	DCC		
NCP1602DFCSNT1G	DFC	DFC		

NOTE: Other L₁, L₂, L₃ combinations are available upon request.
Product versions are coded with three letters (L₁,L₂,L₃).

Table 1. NCP1602 1st LETTER CODING OF PRODUCT VERSIONS

L ₁	Brown-out Function	Skip Mode Function
A	NO	NO
B	NO	YES (trim)
C	YES (trim)	NO
D	YES (trim)	YES (trim)

Table 2. NCP1602 2nd LETTER CODING OF PRODUCT VERSIONS

L ₂	CrM to DCM V _{CTRL} Threshold (V)	t _{ON,max,LL} (μs)	t _{ON,max,HL} (μs)
B	1.026	25	8.33
C	1.296	25	8.33
E	1.553	12.5	4.17
F	2.079	12.5	4.17

Table 3. NCP1602 3rd LETTER CODING OF PRODUCT VERSIONS

L ₃	V _{CC} Startup Level (V)
A	17.0
C	10.5

NCP1602

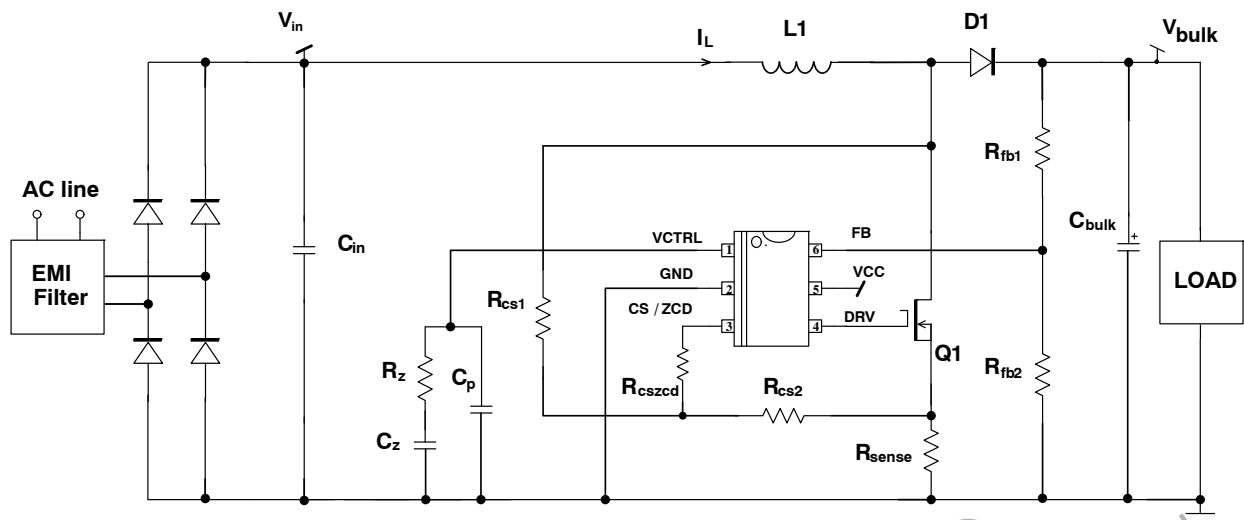

Figure 1. NCP1602 Application Schematic

Table 4. DETAILED PIN DESCRIPTION

Pin Number	Name	Function
1	VCTRL	The error amplifier output is available on this pin. The network connected between this pin and ground adjusts the regulation loop bandwidth that is typically set below 20 Hz to achieve high Power Factor ratios. VCTRL pin is internally pulled down when the circuit is off so that when it starts operation, the power increases slowly to provide a soft-start function. VCTRL pin must not be controlled or pulled down externally.
2	GND	Connect this pin to the PFC stage ground.
3	CS / ZCD	This pin monitors the MOSFET current to limit its maximum current. This pin is the output of a resistor bridge connected between the drain and the source of the power MOSFET. Internal circuitry takes care of extracting V_{in} , V_{out} , I_{ind} and ZCD
4	DRV	The high-current capability of the totem pole gate drive (-0.5/+0.8A) makes it suitable to effectively drive high gate charge power MOSFETs.
5	VCC	This pin is the positive supply of the IC. The circuit starts to operate when VCC exceeds 17.0 V (**A) Versions) or 10.5 V (**C) Versions) and turns off when VCC goes below 9.0 V (typical values). After start-up, the operating range is 9.5 V up to 30 V.
6	FB	This pin receives a portion of the PFC output voltage for the regulation and the Dynamic Response Enhancer (DRE) that drastically speeds-up the loop response when the output voltage drops below 95.5% of the desired output level. FB pin voltage V_{FB} is also the input signal for the (non-latching) Over-Voltage (OVP) and Under-Voltage (UVP) comparators. The UVP comparator prevents operation as long as FB pin voltage is lower than V_{UVPH} internal voltage reference. A SOFTOVP comparator gradually reduces the duty-ratio when FB pin voltage exceeds 105% of V_{REF} . If the output voltage still increases, the driver is immediately disabled if the output voltage exceeds 107% of the desired level (fast OVP). A 250 nA sink current is built-in to trigger the UVP protection and disable the part if the feedback pin is accidentally open.

NCP1602

Table 5. MAXIMUM RATINGS TABLE

Symbol	Pin	Rating	Value	Unit
VCTRL	1	V _{CONTROL} pin	-0.3, V _{ctrl,max} (*)	V
CS/ZCD	3	CS/ZCD Pin	-0.3, +9	V
DRV	4	Driver Voltage Driver Current	-0.3, V _{DRV} (*) -500, +800	V mA
VCC	5	Power Supply Input	-0.3, +30	V
VCC	5	Maximum (dV/dt) that can be applied to VCC	TBD upon test engineer measurements	V/s
FB	6	Feedback Pin	-0.3, +9	V
P _D R _{θJA}		Power Dissipation and Thermal Characteristics Maximum Power Dissipation @ T _A = 70°C Thermal Resistance Junction to Air	550 145	mW °C/W
T _J		Operating Junction Temperature Range	-40 to +125	°C
T _{J,max}		Maximum Junction Temperature	150	°C
T _{S,max}		Storage Temperature Range	-65 to 150	°C
T _{L,max}		Lead Temperature (Soldering, 10 s)	300	°C
MSL		Moisture Sensitivity Level	1	-
		ESD Capability, HBM model (Note 1)	> 2000	V
		ESD Capability, Charged Device Model (Note 1)	> 1500	V

Stresses exceeding those listed in the Maximum Ratings table may damage the device. If any of these limits are exceeded, device functionality should not be assumed, damage may occur and reliability may be affected.

*V_{ctrl,max} is the VCTRL pin clamp voltage. "V_{DRV}" is the DRV clamp voltage (V_{DRVhigh}) if V_{CC} is higher than (V_{DRVhigh}). "V_{DRV}" is V_{CC} otherwise.

1. This device(s) contains ESD protection and exceeds the following tests:

Human Body Model 2000 V per JEDEC Standard JESD22-A114E

Charged Device Model Method 1500 V per JEDEC Standard JESD22-C101E.

2. This device contains latch-up protection and exceeds 100 mA per JEDEC Standard JESD78.

DISCO

THIS DEVICE IS NOT RECOMMENDED FOR NEW DESIGN
PLEASE CONTACT YOUR ONSEMI REPRESENTATIVE FOR INFORMATION

NCP1602

Table 6. TYPICAL ELECTRICAL CHARACTERISTICS

 (Conditions: $V_{CC} = 18\text{ V}$, T_J from -40°C to $+125^\circ\text{C}$, unless otherwise specified) (Note 3)

Symbol	Rating	Min	Typ	Max	Unit
--------	--------	-----	-----	-----	------

START-UP AND SUPPLY CIRCUIT

$V_{CC,on}$	Start-Up Threshold, V_{CC} increasing: [**C] Versions [**A] Versions	9.75 15.80	10.50 17.00	11.25 18.20	V
$V_{CC,off}$	Minimum Operating Voltage, V_{CC} falling	8.50	9.00	9.50	V
$V_{CC,hyst}$	Hysteresis ($V_{CC,on} - V_{CC,off}$) [**C] Versions [**A] Versions	0.75 6.00	1.50 8.00	- -	V
$I_{CC,start}$	Maximum Start-Up Current, for V_{CC} lower than 9.4 V, below startup voltage	-	-	480	μA
$I_{CC,op1}$	Operating Consumption, no switching.	-	0.5	1.00	mA
$I_{CC,op2}$	Operating Consumption, 50 kHz switching, no load on DRV pin	-	2.00	3.00	mA

FREQUENCY FOLD-BACK DEAD TIME FOR CONFIGURATIONS $L_2 = \text{B, C, E, F}$ @ $K_m = 2.28$

$t_{DT,B,1}$	Dead-Time, $V_{ctrl} = 0.65\text{V}$ w/ B config	5.73	7.64	9.55	μs
$t_{DT,B,2}$	Dead-Time, $V_{ctrl} = 0.75\text{V}$ w/ B config	2.91	3.88	4.85	μs
$t_{DT,C,1}$	Dead-Time, $V_{ctrl} = 0.65\text{V}$ w/ C config	8.90	11.90	14.84	μs
$t_{DT,C,2}$	Dead-Time, $V_{ctrl} = 0.75\text{V}$ w/ C config	5.69	7.50	9.48	μs
$t_{DT,E,1}$	Dead-Time, $V_{ctrl} = 0.65\text{V}$ w/ E config	9.96	13.28	16.60	μs
$t_{DT,E,2}$	Dead-Time, $V_{ctrl} = 0.75\text{V}$ w/ E config	6.70	8.93	10.80	μs
$t_{DT,F,1}$	Dead-Time, $V_{ctrl} = 0.65\text{V}$ w/ F config	13.00	17.30	21.66	μs
$t_{DT,F,2}$	Dead-Time, $V_{ctrl} = 0.75\text{V}$ w/ F config	9.97	13.10	16.61	μs

CrM TO DCM THRESHOLD AND HYSTERESIS

$V_{ctrl,th,B}$	V_{ctrl} threshold CrM to DCM mode w/ B config	0.923	1.026	1.129	V
$V_{ctrl,th,C}$	V_{ctrl} threshold CrM to DCM mode w/ C config	1.16	1.29	1.43	V
$V_{ctrl,th,E}$	V_{ctrl} threshold CrM to DCM mode w/ E config	1.398	1.553	1.708	V
$V_{ctrl,th,F}$	V_{ctrl} threshold CrM to DCM mode w/ F config	1.865	2.08	2.29	V

SKIP CONTROL ([] & [D**] Versions)**

V_{SKIP-H}	V_{ctrl} pin SKIP Level, $V_{control}$ rising	555	617	678	mV
V_{SKIP-L}	V_{ctrl} pin SKIP Level, $V_{control}$ falling	516	593	665	mV
$V_{SKIP-Hyst}$	V_{ctrl} pin SKIP Hysteresis	-	30	-	mV

GATE DRIVE

t_R	Output voltage rise-time @ $C_L = 1\text{ nF}$, 10-90% of output signal	-	30	-	ns
t_F	Output voltage fall-time @ $C_L = 1\text{ nF}$, 10-90% of output signal	-	20	-	ns
R_{OH}	Source resistance @ 200 mV under High VCC	-	10	-	Ω
R_{OL}	Sink resistance @200 mV above Low VCC	-	7	-	Ω
$V_{DRV,low}$	DRV pin level for $V_{CC} = V_{CC,off} + 200\text{ mV}$ (10 k Ω resistor between DRV and GND)	8.0	-	-	V
$V_{DRV,high}$	DRV pin level at $V_{CC} = 30\text{ V}$ ($R_L = 33\text{ k}\Omega$ & $C_L = 1\text{ nF}$)	10	12	14	V

REGULATION BLOCK

V_{REF}	Feedback Voltage Reference	2.44	2.50	2.56	V
I_{EA}	Error Amplifier Current Capability, Sinking and Sourcing	15	20	26	μA
G_{EA}	Error Amplifier Gain	110	200	290	μS

Product parametric performance is indicated in the Electrical Characteristics for the listed test conditions, unless otherwise noted. Product performance may not be indicated by the Electrical Characteristics if operated under different conditions.

3. The above specification gives the targeted values of the parameters. The final specification will be available once the complete circuit characterization has been performed.

NCP1602

Table 6. TYPICAL ELECTRICAL CHARACTERISTICS

(Conditions: $V_{CC} = 18\text{ V}$, T_J from -40°C to $+125^\circ\text{C}$, unless otherwise specified) (Note 3)

Symbol	Rating	Min	Typ	Max	Unit
REGULATION BLOCK					
V_{ctrl} $V_{ctrl,min}$ $V_{ctrl,max}$	V_{CTRL} pin Voltage (V_{ctrl}): - @ $V_{FB} = 2\text{ V}$ (OTA is sourcing $20\ \mu\text{A}$) - @ $V_{FB} = 3\text{ V}$ (OTA is sinking $20\ \mu\text{A}$)	- -	4.5 0.5	- -	V V
$V_{out,L} / V_{REF2}$	Ratio (V_{out} Low Detect Threshold / V_{REF}) (guaranteed by design)	-	95.5	-	%
$H_{out,L} / V_{REF2}$	Ratio (V_{out} Low Detect Hysteresis / V_{REF}) (guaranteed by design)	-	0.35	-	%
I_{BOOST}	V_{CTRL} pin Source Current when (V_{OUT} Low Detect) is activated	147	220	277	μA

CURRENT SENSE AND ZERO CURRENT DETECTION BLOCKS

$V_{CS(th)}$	Current Sense Voltage Reference	450	500	550	mV
$V_{CS,OVs(th)}$	Current Sense Overstress Voltage Reference	675	750	825	mV
$t_{LEB,OVs}$	"Overstress" Leading edge Blanking Time (guaranteed by design)	-	250	-	ns
$t_{LEB,OCp}$	"Over-Current Protection" Leading edge Blanking Time (guaranteed by design)	-	400	-	ns
t_{OCp}	Over-Current Protection Delay from $V_{CS/ZCD} > V_{CS(th)}$ to DRV low ($dV_{CS/ZCD} / dt = 10\text{ V}/\mu\text{s}$)	-	40	200	ns
$V_{ZCD(th)H}$	Zero Current Detection, $V_{CS/ZCD}$ rising	8	35	62	mV
$V_{ZCD(th)L}$	Zero Current Detection, $V_{CS/ZCD}$ falling	-68	-46	-25	mV
$V_{ZCD(hyst)}$	Hysteresis of the Zero Current Detection Comparator	46	84	-	mV
To discuss versus what esd protection will be used					
$V_{CL(pos)}$	CS/ZCD Positive Clamp @ $I_{CS/ZCD} = 5\text{ mA}$ (guaranteed by design)	-	9.5	-	V
t_{ZCD}	($V_{CS/ZCD} < V_{ZCD(th)L}$) to (DRV high)	-	60	200	ns
t_{SYNC}	Minimum ZCD Pulse Width	-	110	200	ns
t_{WDG}	Watch Dog Timer	80	200	320	μs
$t_{WDG(OS)}$	Watch Dog Timer in "OverStress" Situation	400	800	1200	μs
$I_{ZCD(gnd)}$	Source Current for CS/ZCD pin impedance Testing	-	50	-	μA
$I_{ZCD(Vcc)}$	Pull-up current source referenced to V_{CC} for open pin detection	-	200	-	nA

STATIC OVP

D_{MIN}	Duty Cycle, $V_{FB} = 3\text{ V}$ (When low clamp of V_{ctrl} is reached)	-	-	0	%
-----------	---	---	---	---	---

ON-TIME CONTROL (Options [*E*], [*B*], [*F*], [*C*] for maximum t_{ON} value)

$t_{on,LL,B}$	Maximum On Time, $avg(V_{CS}) = 0.9\text{ V}$ and V_{ctrl} maximum (CrM)	22	25	28	μs
$t_{on,HL,B}$	Maximum On Time, $avg(V_{CS}) = 2.8\text{ V}$ and V_{ctrl} maximum (CrM)	7.49	8.33	9.16	μs
$t_{on,LL,C}$	Maximum On Time, $avg(V_{CS}) = 0.9\text{ V}$ and V_{ctrl} maximum (CrM)	22	25	28	μs
$t_{on,HL,C}$	Maximum On Time, $avg(V_{CS}) = 2.8\text{ V}$ and V_{ctrl} maximum (CrM)	7.49	8.40	9.16	μs
$t_{on,LL,E}$	Maximum On Time, $avg(V_{CS}) = 0.9\text{ V}$ and V_{ctrl} maximum (CrM)	11.4	12.5	13.6	μs
$t_{on,HL,E}$	Maximum On Time, $avg(V_{CS}) = 2.8\text{ V}$ and V_{ctrl} maximum (CrM)	3.75	4.17	4.59	μs
$t_{on,LL,F}$	Maximum On Time, $avg(V_{CS}) = 0.9\text{ V}$ and V_{ctrl} maximum (CrM)	11.4	12.5	13.6	μs
$t_{on,HL,F}$	Maximum On Time, $avg(V_{CS}) = 2.8\text{ V}$ and V_{ctrl} maximum (CrM)	3.75	4.20	4.59	μs
$K_{ton,LL-HL}$	t_{ON} @LL over t_{ON} @HL ratio (all t_{ON} versions)	-	3	-	w/o
Specifying max $t_{ON,min}$ means $t_{ON,min}$ can go down to zero					
$t_{on,LL,min}$	Minimum On Time, $avg(V_{CS}) = 0.9\text{ V}$ (not tested, guaranteed by design)	-	300	-	ns

Product parametric performance is indicated in the Electrical Characteristics for the listed test conditions, unless otherwise noted. Product performance may not be indicated by the Electrical Characteristics if operated under different conditions.

3. The above specification gives the targeted values of the parameters. The final specification will be available once the complete circuit characterization has been performed.

NCP1602

Table 6. TYPICAL ELECTRICAL CHARACTERISTICS

(Conditions: $V_{CC} = 18\text{ V}$, T_J from -40°C to $+125^\circ\text{C}$, unless otherwise specified) (Note 3)

Symbol	Rating	Min	Typ	Max	Unit
ON-TIME CONTROL (Options [*E*], [*B*], [*F*], [*C*] for maximum t_{ON} value)					
$t_{on,HL,min}$	Minimum On Time, $avg(V_{CS}) = 2.8\text{ V}$ (not tested, guaranteed by design)	–	200	–	ns
FEED-BACK OVER AND UNDER-VOLTAGE PROTECTIONS (OVP and UVP)					
$R_{softOVP}$	Ratio (Soft OVP Threshold, V_{FB} rising) over V_{REF} (or V_{REF2}) (guaranteed by design)	–	105	–	%
$R_{softOVP(HYST)}$	Ratio (Soft OVP Hysteresis) over V_{REF} (or V_{REF2}) (guaranteed by design)	–	1.87	–	%
$R_{fastOVP}$	Ratio (Fast OVP Threshold, V_{FB} rising) over V_{REF} (or V_{REF2}) (guaranteed by design)	–	107	–	%
$R_{fastOVP(HYST)}$	Ratio (Fast OVP Hysteresis) over V_{REF} (or V_{REF2}) (guaranteed by design)	–	4.0	–	%
V_{UVPH}	UVP Threshold, V_{FB} increasing	555	612	670	mV
V_{UVPL}	UVP Threshold, V_{FB} decreasing	252	303	357	mV
$V_{UVPH(HYST)}$	UVP Hysteresis	273	307	342	mV
$I_{B,FB}$	FB pin Bias Current @ $V_{FB} = V_{OVP}$ and $V_{FB} = V_{UVP}$	50	200	450	nA
BROWN-OUT PROTECTION AND FEED-FORWARD (V_{sense} is an internal pin that replaces V_{sense})					
V_{BOH}	Brown-Out Threshold V_{mains} increasing, V_{FB} based ([C**] and [D**] versions)	754	819	894	mV
V_{BOL}	Brown-Out Threshold, V_{mains} decreasing, $avg(V_{CS})$ based ([C**] and [D**] versions)	659	737	801	mV
$V_{BO(HYST)}$	Brown-Out Comparator Hysteresis ([C**] and [D**] versions)	75	100	–	mV
$t_{BO(blank)}$	Brown-Out Blanking Time ([C**] and [D**] versions)	36	50	67	ms
$I_{VCTRL(BO)}$	VCTRL pin sink current during BO condition	20	30	42	μA
V_{HL}	Comparator Threshold for Line Range Detection, $avg(V_{CS})$ rising	1.718	1.801	1.882	V
V_{LL}	Comparator Threshold for Line Range Detection, $avg(V_{CS})$ falling	1.310	1.392	1.474	V
$V_{HL(hyst)}$	Comparator Hysteresis for Line Range Detection	75	400	–	mV
$t_{HL(blank)}$	Blanking Time for Line Range Detection	13	25	43	ms
THERMAL SHUTDOWN					
T_{LIMIT}	Thermal Shutdown Threshold	150	–	–	$^\circ\text{C}$
H_{TEMP}	Thermal Shutdown Hysteresis	–	50	–	$^\circ\text{C}$
SECOND OVERVOLTAGE PROTECTION (OVP2)					
$V_{OVP2H,HL}$	OVP2 Threshold, V_{CS} rising, $K_{CS} = 138$, @ $V_{REF2} = 2.5\text{ V}$	3.048	3.175	3.302	V
$V_{OVP2L,HL}$	OVP2 Threshold, V_{CS} falling, $K_{CS} = 138$, @ $V_{REF2} = 2.5\text{ V}$	2.969	3.093	3.217	V
$V_{OVP2(HYST),HL}$	OVP2 Comparator Hysteresis, $K_{CS} = 138$, @ $V_{REF2} = 2.5\text{ V}$	50	100	–	mV
$t_{LEB,OVP2}$	OVP2 Leading Edge Blanking Time, V_{CS} rising (guaranteed by design)	–	1000	–	ns
$t_{RST(OVP2)}$	Reset Timer for OVP2 latch	400	800	1200	μs

Product parametric performance is indicated in the Electrical Characteristics for the listed test conditions, unless otherwise noted. Product performance may not be indicated by the Electrical Characteristics if operated under different conditions.

3. The above specification gives the targeted values of the parameters. The final specification will be available once the complete circuit characterization has been performed.

NCP1602

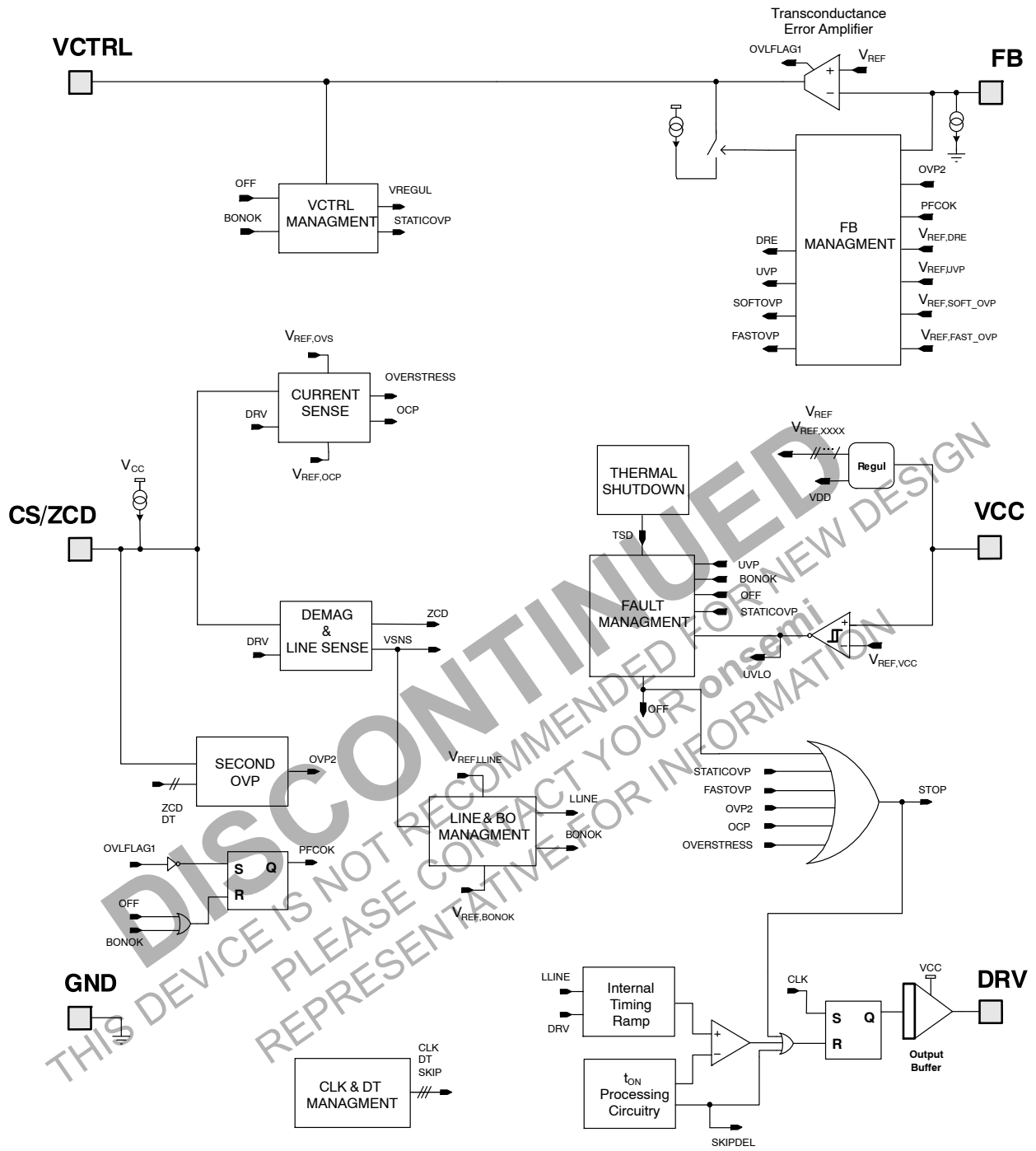

Figure 2. NCP1602 Block Diagram

NCP1602

TYPICAL CHARACTERISTICS

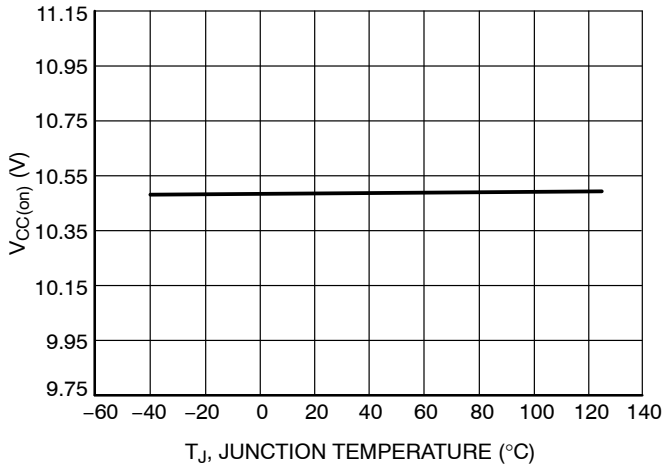

Figure 3. Start-Up Threshold, V_{CC} Increasing ($V_{CC,on}$) vs. Junction Temperature (versions [C]&[**D])**

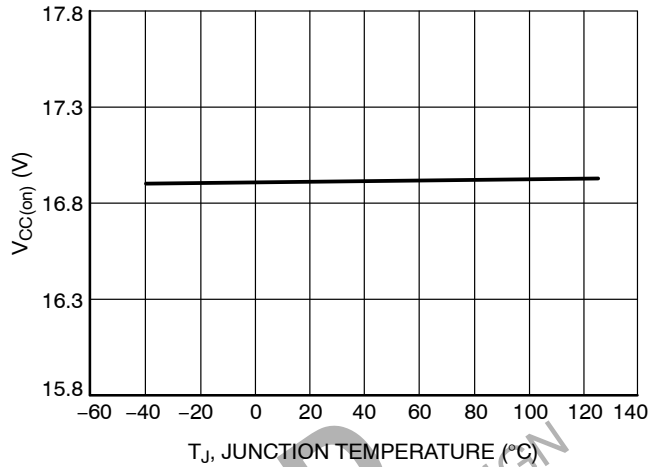

Figure 4. Start-Up Threshold, V_{CC} Increasing ($V_{CC,on}$) vs. Junction Temperature (versions [A]&[**B])**

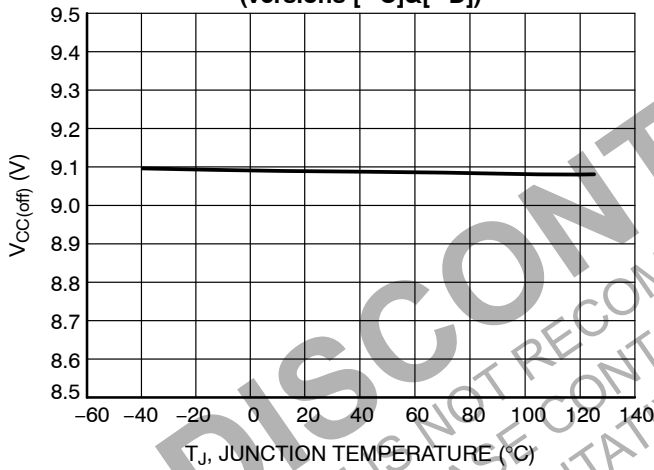

Figure 5. Minimum Operating Voltage, V_{CC} Falling ($V_{CC,off}$) vs. Junction Temperature

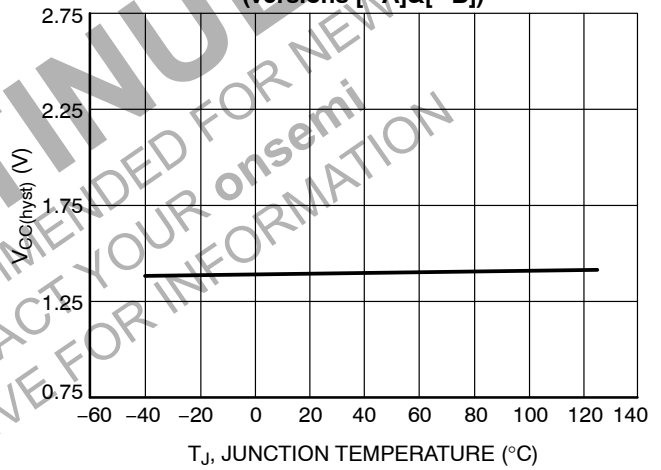

Figure 6. Hysteresis ($V_{CC,on} - V_{CC,off}$) vs. Junction Temperature (versions [C]&[**D])**

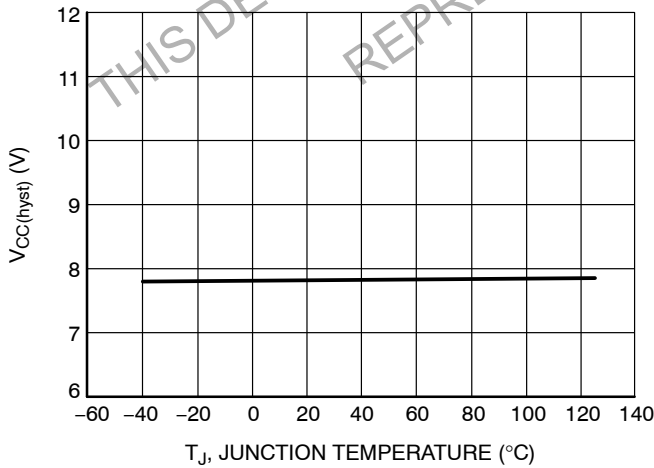

Figure 7. Hysteresis ($V_{CC,on} - V_{CC,off}$) vs. Junction Temperature (versions [A]&[**B])**

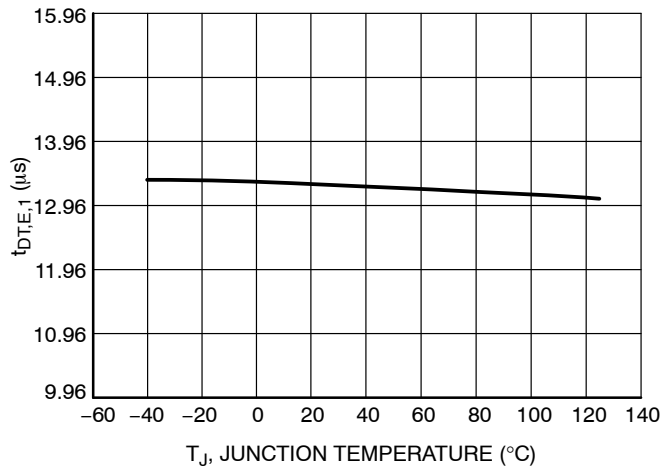

Figure 8. Dead-Time, $V_{ctrl} = 0.65$ V w/ E Config ($t_{DTE,1}$) vs. Junction Temperature

TYPICAL CHARACTERISTICS

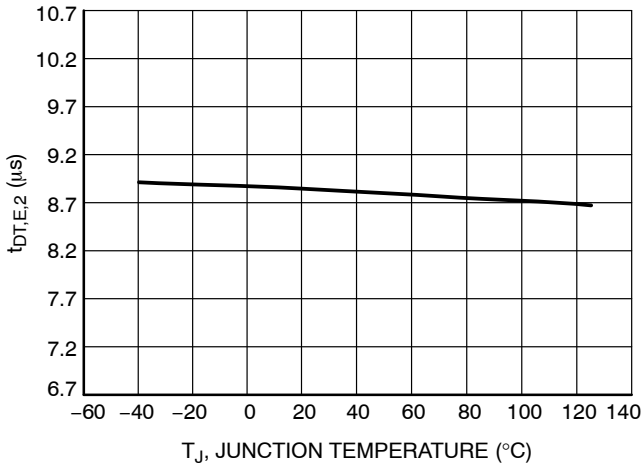

Figure 9. Dead-Time, $V_{ctrl} = 0.75\text{ V}$ w/ E Config ($t_{DT,E,2}$) vs. Junction Temperature

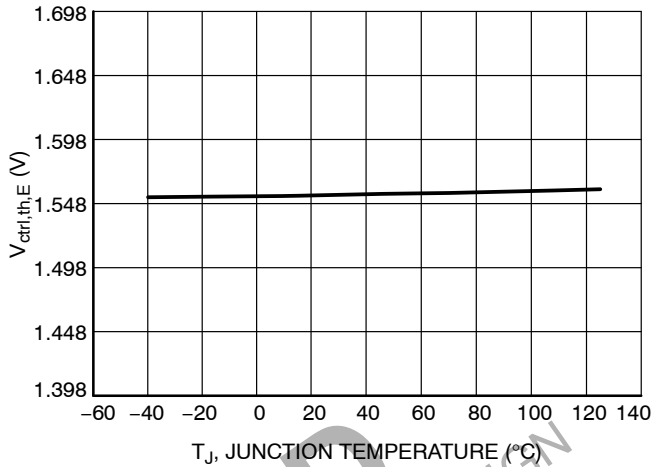

Figure 10. V_{ctrl} Threshold CrM to DCM Mode w/ E Config ($V_{ctrl,th,E}$) vs. Junction Temperature

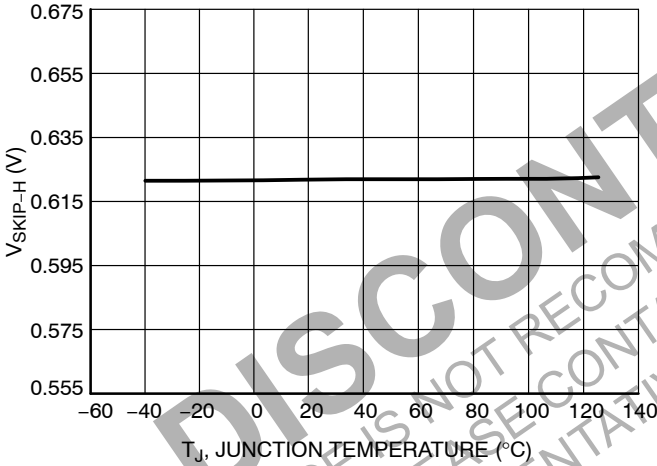

Figure 11. V_{ctrl} Pin SKIP Level, V_{ctrl} Rising (V_{SKIP-H}) vs. Junction Temperature

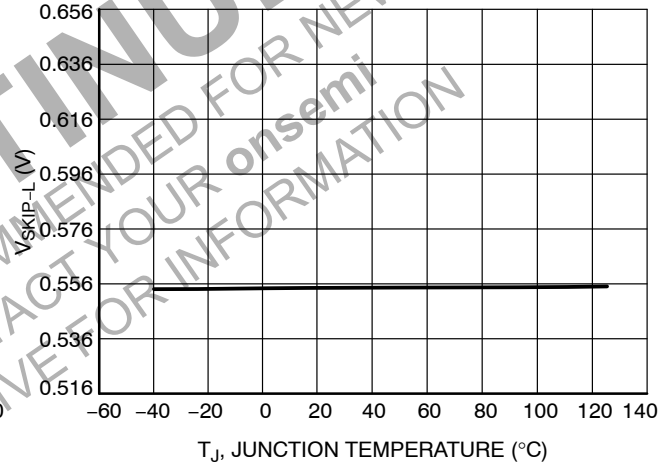

Figure 12. V_{ctrl} pin SKIP Level, V_{ctrl} Falling (V_{SKIP-L}) vs. Junction Temperature

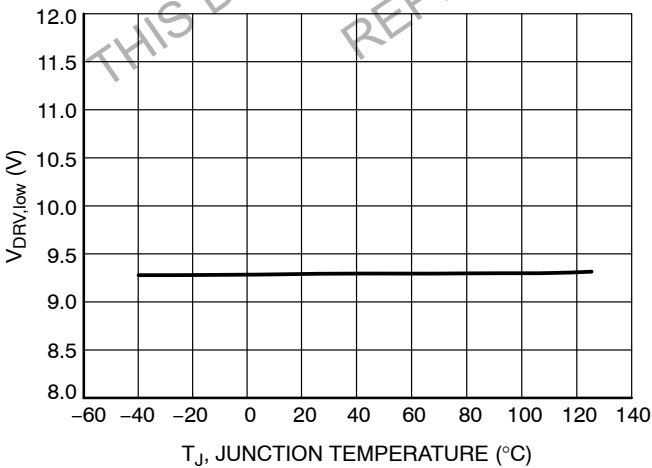

Figure 13. DRV Pin Level for $V_{CC} = V_{CC,off} + 200\text{ mV}$ (10-kΩ Resistor between DRV and GND) ($V_{DRV,low}$) vs. Junction Temperature

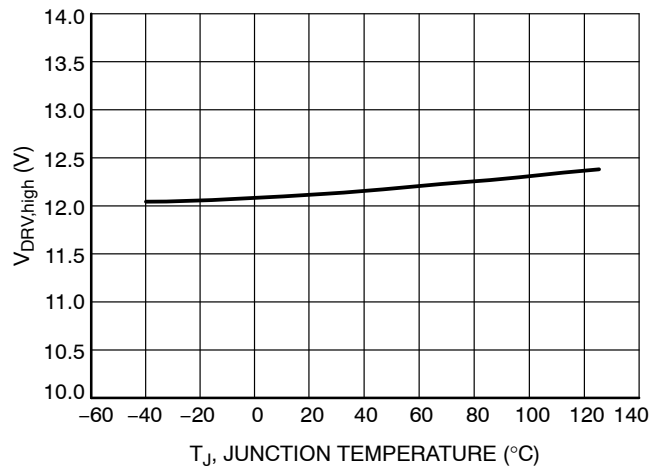

Figure 14. DRV Pin Level @ $V_{CC} = 30\text{ V}$ ($R_L = 33\text{ k}\Omega$ & $C_L = 1\text{ nF}$) ($V_{DRV,high}$) vs. Junction Temperature

TYPICAL CHARACTERISTICS

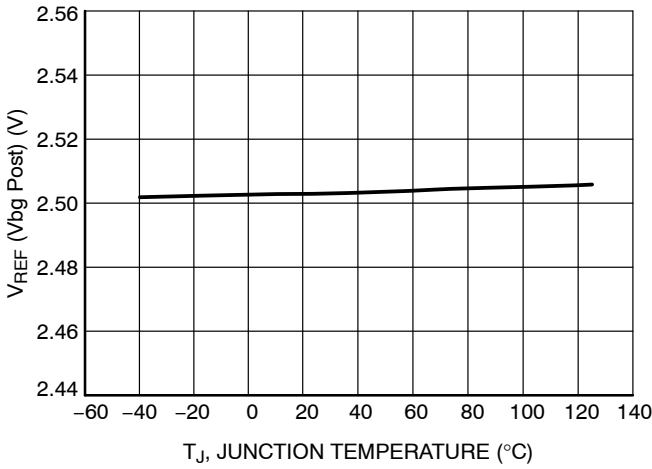

Figure 15. Feedback Voltage Reference (V_{REF}) vs. Junction Temperature

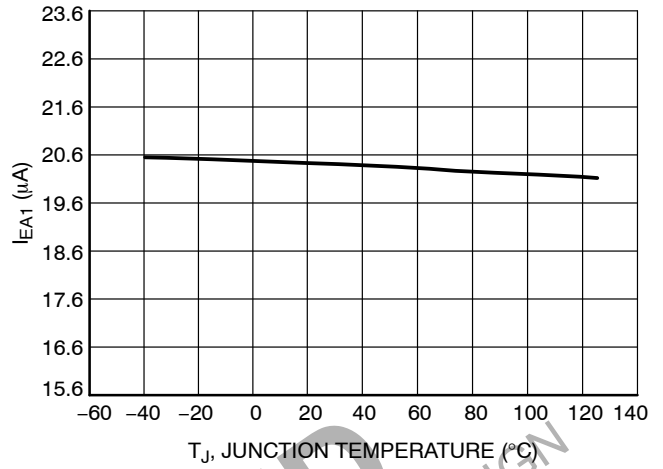

Figure 16. Error Amplifier Current Capability, Sourcing (I_{EA1}) vs. Junction Temperature

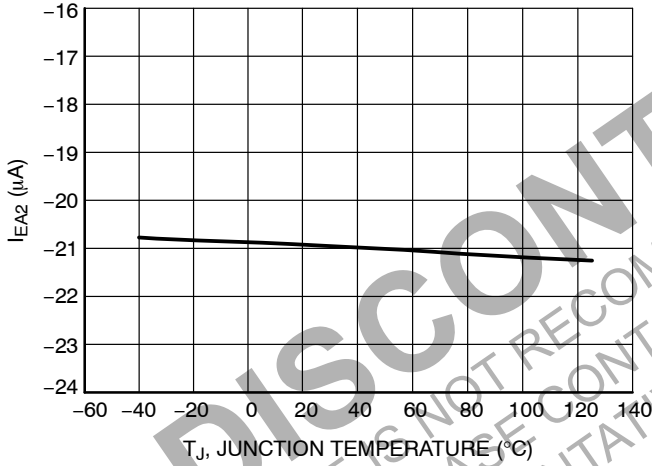

Figure 17. Error Amplifier Current Capability, Sinking (I_{EA2}) vs. Junction Temperature

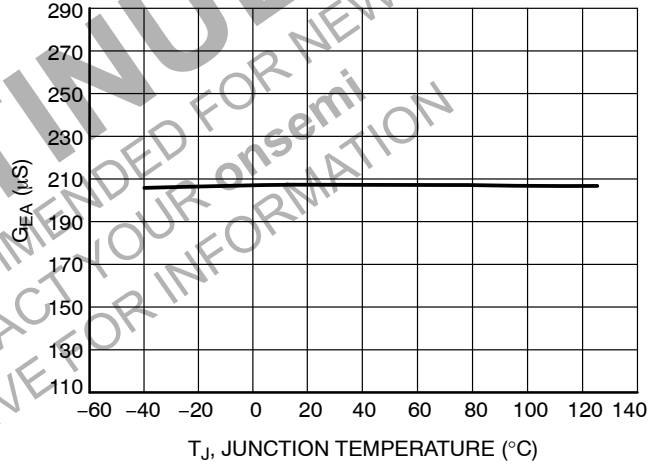

Figure 18. Error Amplifier Transconductance (G_{EA}) vs. Junction Temperature

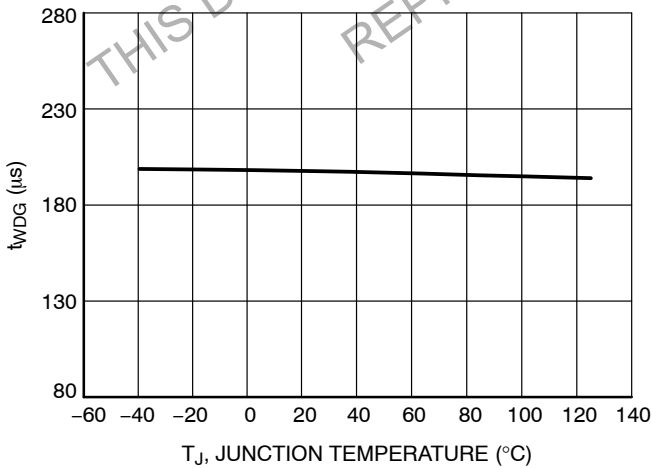

Figure 19. Watch Dog Timer Duration (t_{WDG}) vs. Junction Temperature

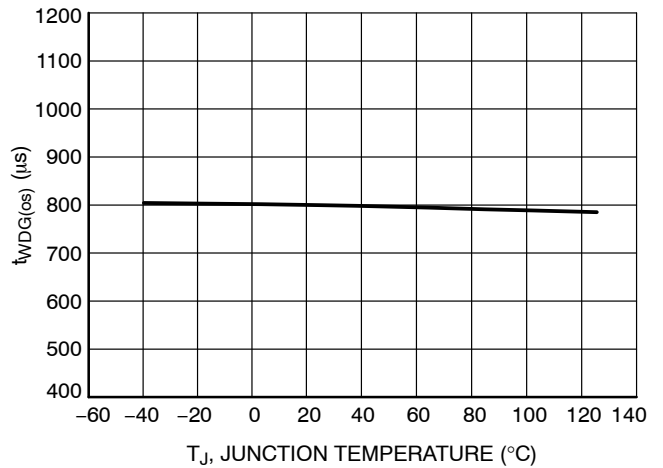

Figure 20. Watch Dog Timer Duration in "OverStress" Situation ($t_{WDG(OS)}$) vs. Junction Temperature

TYPICAL CHARACTERISTICS

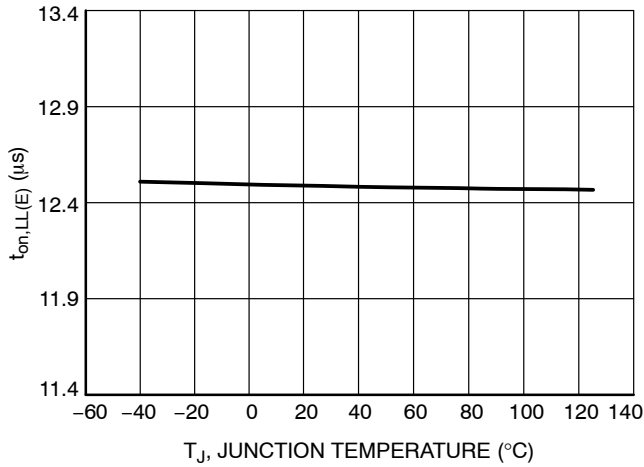

Figure 21. Maximum On Time, avg(V_{CS}) = 0.9 V & V_{ctrl} Maximum (CrM) & Low Line for E Version (t_{on,LL,E}) vs. Junction Temperature

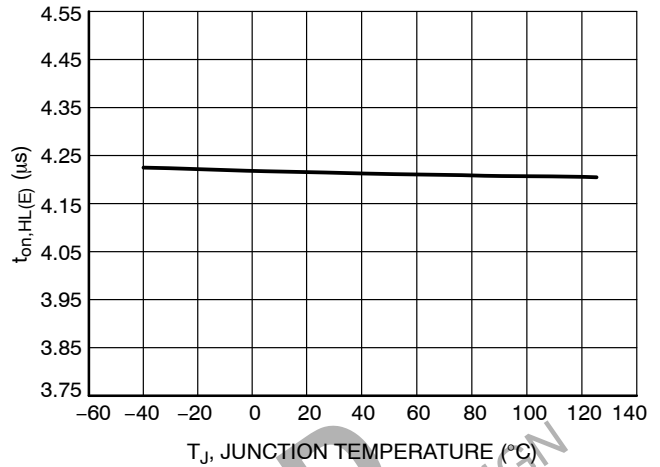

Figure 22. Maximum On Time, avg(V_{CS}) = 2.8 V & V_{ctrl} Maximum (CrM) & High Line for E Version (t_{on,HL,E}) vs. Junction Temperature

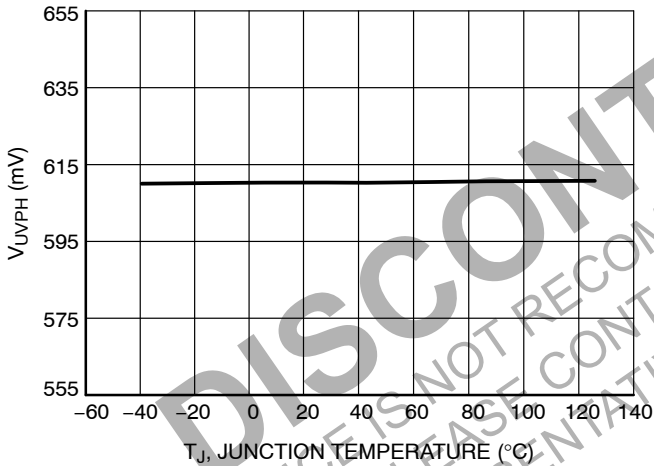

Figure 23. UVP Threshold, V_{FB} Increasing (V_{UVPH}) vs. Junction Temperature

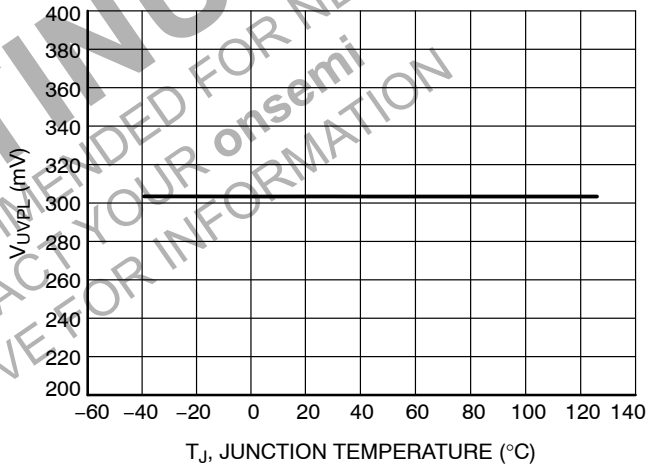

Figure 24. UVP Threshold, V_{FB} Decreasing (V_{UVPL}) vs. Junction Temperature

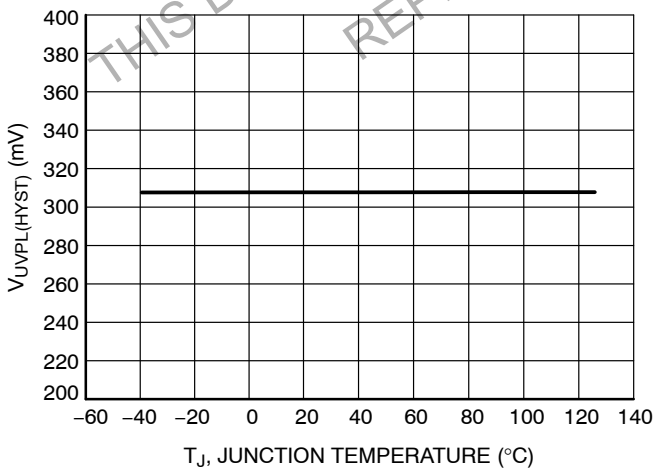

Figure 25. UVP Threshold Hysteresis (V_{UVPL(HYST)}) vs. Junction Temperature

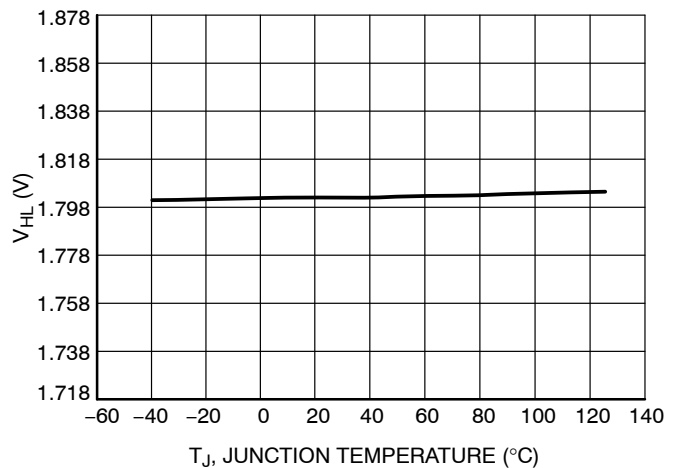

Figure 26. Comparator Threshold for Line Range Detection, avg(V_{CS}) Rising, (V_{HL}) vs. Junction Temperature

NCP1602

TYPICAL CHARACTERISTICS

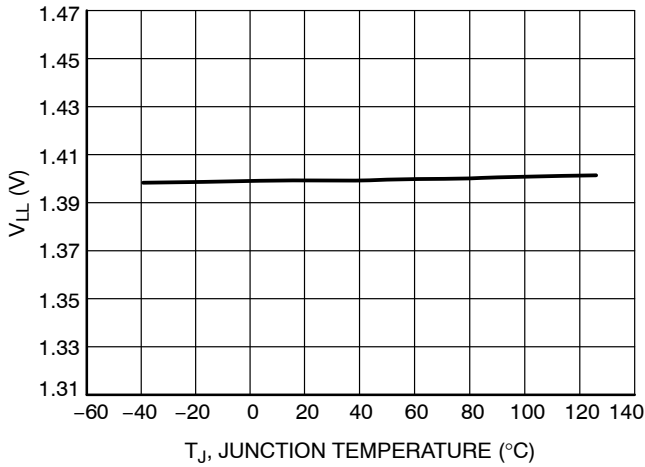

Figure 27. Comparator Threshold for Line Range Detection, avg(V_{CS}) Falling, (V_{LL}) vs. Junction Temperature

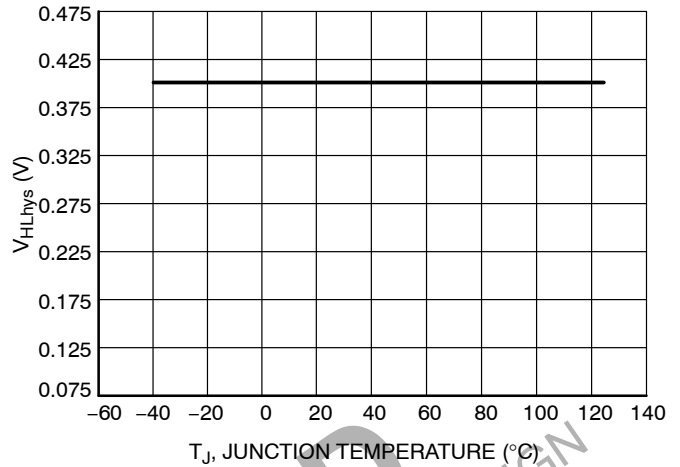

Figure 28. Comparator Hysteresis for Line Range Detection, (V_{HL(hyst)}) vs. Junction Temperature

DISCONTINUED
THIS DEVICE IS NOT RECOMMENDED FOR NEW DESIGN
PLEASE CONTACT YOUR onsemi
REPRESENTATIVE FOR INFORMATION

Detailed Operating Description

Introduction

NCP1602 is designed to optimize the efficiency of your PFC stage throughout the load range. In addition, it incorporates protection features for rugged operation. More generally, NCP1602 is ideal in systems where cost-effectiveness, reliability, low stand-by power and high efficiency are key requirements:

- **Valley Synchronized Frequency Fold-back:**

NCP1602 is designed to drive PFC boost stages in so-called Valley Synchronized Frequency Fold-back (*VSFF*). In this mode, the circuit classically operates in Critical conduction Mode (*CrM*) when V_{ctrl} exceeds a programmable value. When the V_{ctrl} is below this preset level, NCP1602 linearly reduces the frequency down to about 33 kHz before reaching the SKIP threshold voltage (SKIP Mode versions [B**] and [D**]). *VSFF* maximizes the efficiency at both nominal and light load. In particular, stand-by losses are reduced to a minimum. Similarly to *FCCrM* controllers, an internal circuitry allows near-unity power factor even when the switching frequency is reduced.

- **SKIP Mode (Versions [B**] and [D**]):**

to further optimize the efficiency, the circuit skips cycles at low load current when V_{ctrl} reaches the SKIP threshold voltage. This is to avoid circuit operation when the power transfer is particularly inefficient at the cost of current distortion. This SKIP function is not present on versions [A**] and [C**].

- **Low Start-up Current and large V_{CC} range ([**A] versions):** The start-up consumption of the circuit is minimized to allow the use of high-impedance start-up resistors to pre-charge the V_{CC} capacitor. Also, the minimum value of the UVLO hysteresis is 6 V to avoid the need for large V_{CC} capacitors and help shorten the start-up time without the need for too dissipative start-up elements. The [**C] version is preferred in applications where the circuit is fed by an external power source (from an auxiliary power supply or from a downstream converter). Its maximum start-up level (11.25 V) is set low enough so that the circuit can be powered from a 12-V rail. After start-up, the high V_{CC} maximum rating allows a large operating range from 9.5 V up to 30 V.

- **Fast Line / Load Transient Compensation (Dynamic Response Enhancer):** Since PFC stages exhibit low loop bandwidth, abrupt changes in the load or input voltage (e.g. at start-up) may cause excessive over or under-shoot. This circuit limits possible deviations from the regulation level as follows:

- ◆ NCP1602 linearly decays the power delivery to zero when the output voltage exceeds 105% of its desired

level (soft OVP). If this soft OVP is too smooth and the output continues to rise, the circuit immediately interrupts the power delivery when the output voltage is 107% above its desired level.

- ◆ NCP1602, dramatically speeds-up the regulation loop when the output voltage goes below 95.5% of its regulation level. This function is enabled only after the PFC stage has started-up to allow normal soft-start operation to occur.
- **Safety Protections:** Permanently monitoring the input and output voltages, the MOSFET current and the die temperature to protect the system from possible over-stress making the PFC stage extremely robust and reliable. In addition to the OVP protection, the following methods of protection are provided:
 - ◆ **Maximum Current Limit:** The circuit senses the MOSFET current and turns off the power switch if the set current limit is exceeded. In addition, the circuit enters a low duty-cycle operation mode when the current reaches 150% of the current limit as a result of the inductor saturation or a short of the bypass diode.
 - ◆ **Under-Voltage Protection:** This circuit turns off when it detects that the output voltage is below 12% of the voltage reference (typically). This feature protects the PFC stage if the ac line is too low or if there is a failure in the feedback network (e.g., bad connection).
 - ◆ **Brown-Out Detection:** The circuit detects low ac line conditions and stops operation thus protecting the PFC stage from excessive stress.
 - ◆ **Thermal Shutdown:** An internal thermal circuitry disables the gate drive when the junction temperature exceeds 150°C (typically). The circuit resumes operation once the temperature drops below approximately 100°C (50°C hysteresis).
- **Output Stage Totem Pole:** NCP1602 incorporates a -0.5 A / +0.8 A gate driver to efficiently drive most TO220 or TO247 power MOSFETs.

NCP1602 Operation Modes

As mentioned, NCP1602 PFC controller implements a Valley Synchronized Frequency Fold-back (*VSFF*) where:

- ◆ The circuit operates in classical Critical conduction Mode (*CrM*) when V_{ctrl} exceeds a programmable value $V_{ctrl,th,*}$.
- ◆ When V_{ctrl} is below this $V_{ctrl,th,*}$, the NCP1602 linearly reduces the operating frequency down to about 33 kHz
- ◆ When V_{ctrl} reaches V_{ctrl} minimum value or the V_{ctrl} SKIP mode threshold, the system works in low frequency burst mode.

NCP1602

High Current
No delay → CrM



Low Current
The next cycle is delayed

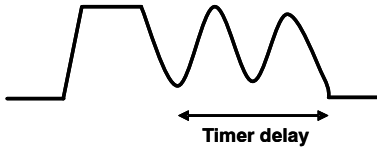

Lower Current
Longer dead-time

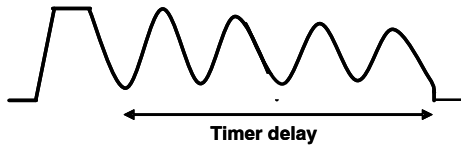

Figure 29. Valley Switching Operation in CrM and DCM Modes

As illustrated in Figure 29, under high load conditions, the boost stage is operating in CrM but as the load is reduced, the controller enters controlled frequency discontinuous operation.

To further reduce the losses, the MOSFET turn-on is stretched until its drain-source voltage is at its valley. The end of the dead time is synchronized with the drain-source ringing.

Valley Synchronized Frequency Foldback (VSFF) a/ Valley Synchronized (VS)

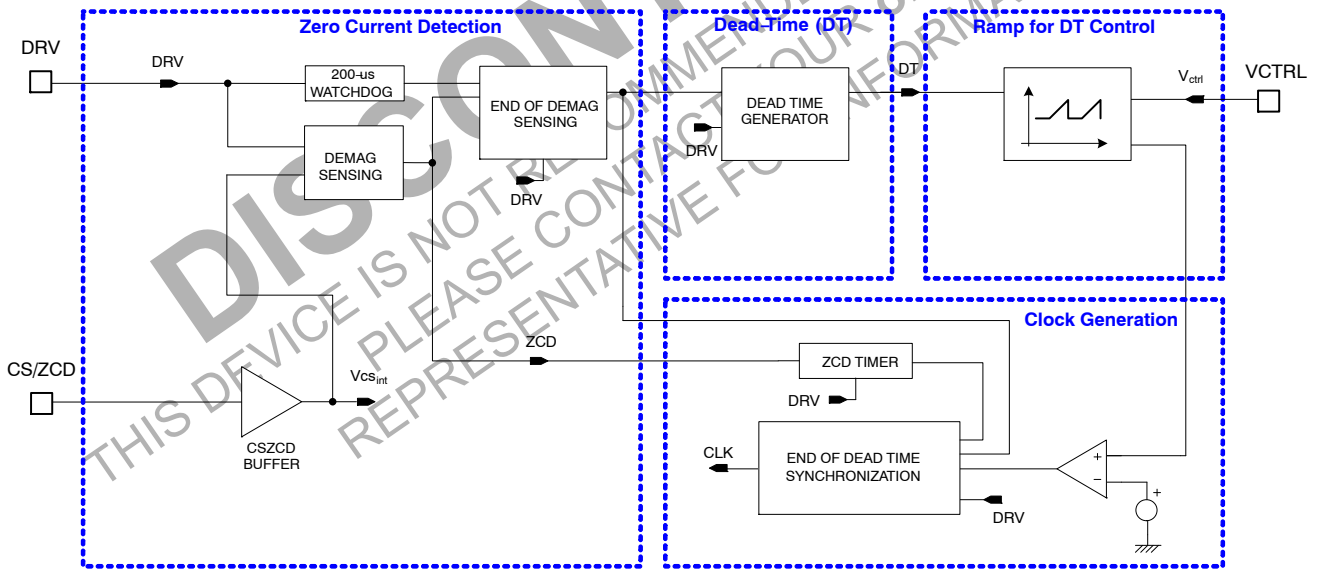

Figure 30. Valley Synchronized Turn-on Block Diagram

Valley Synchronized is the first half of the VSFF system.

Synchronizing the Turn-on with the drain voltage valley maximizes the efficiency at both nominal and light load conditions. In particular, the stand-by losses are reduced to a minimum. The synchronization of Power MOSFET Turn-on (rising edge of CLK signal) with drain voltage valley is depicted on Figure 30. This method avoids system stalls between valleys. Instead, the circuit acts so that the PFC controller transitions from the n valley to $(n+1)$ valley or vice versa from the n valley to $(n-1)$ cleanly as illustrated

by the simulation results of Figure 31. When the Line voltage and inductor current are very low, or when the amplitude of the drain voltage gets too low (in the case of long dead times), the turn-on of the power MOSFET is no longer synchronized with the drain valley but will start exactly at the end of a programmed dead time looks to the ZCD TIMER block.

If no demagnetization is sensed the power MOSFET will be turned-on after a watchdog timing of 200- μ s.

NCP1602

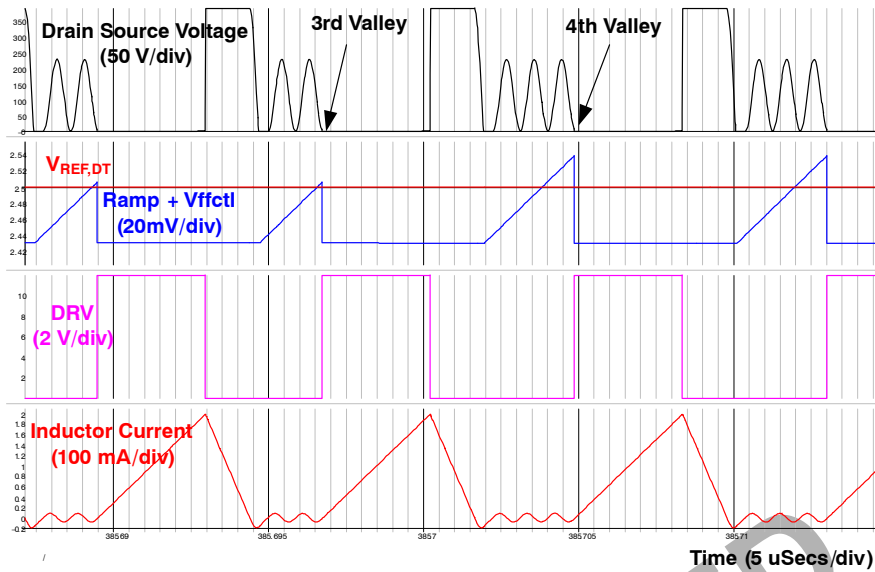

Figure 31. Clean Transition Without Hesitation Between Valleys

b/ Frequency Foldback (FF)

Frequency Foldback is the second half of the VSFF system.

When V_{ctrl} falls below an option-programmable $V_{ctrl,th,*}$ threshold, the NCP1602 enters DCM and linearly reduces the operating frequency down to about 33 kHz by adding a dead-time after the end of inductor demagnetization. The end of the dead-time is synchronized with the valley in the

drain voltage, hence the name Valley Synchronized (VS). The lower the V_{ctrl} value, the longer the dead-time.

The Frequency Foldback (FF) system adjusts the on-time versus t_{DT} (see Figure 32) and the output power in order to ensure that the instantaneous mains current is in phase with the mains instantaneous voltage (creating a PF=1).

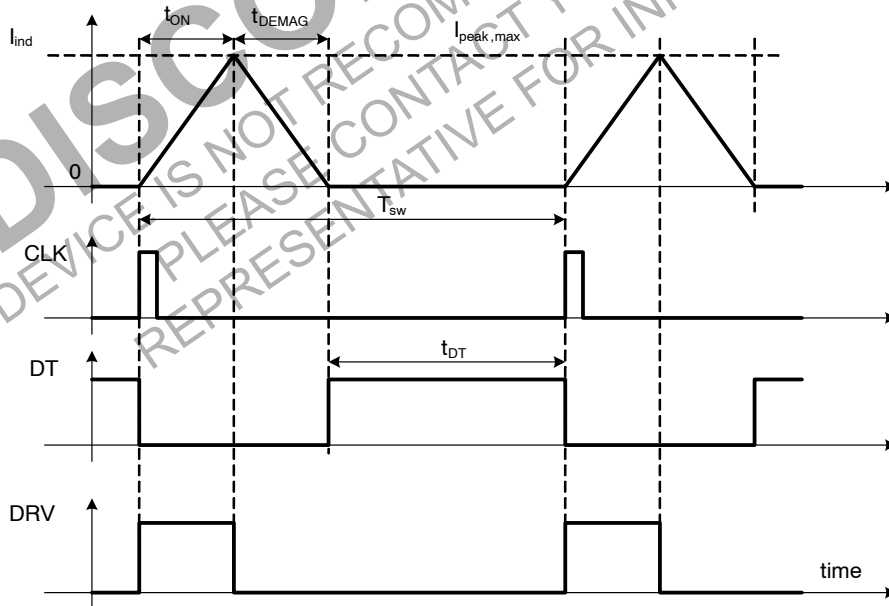

Figure 32. NCP1602 Clock, Dead Time and t_{ON} Waveforms

When the load is at its maximum (the maximum V_{ctrl} value and inductor peak current limitation is not triggering), the controller runs in CrM mode and the frequency ($@V_{in}=V_{in,max}$) has its minimum value. As we start decreasing the output power, the V_{ctrl} voltage decreases, the switching frequency ($@V_{in}=V_{in,max}$) increases and the controller stays in CrM mode until V_{ctrl} reaches a threshold voltage named $V_{ctrl,th,*}$. From this point, continuing to reduce the output power makes the controller to continue increase the dead time (T_{DT}) after the end of demagnetization resulting in a DCM conduction mode and a switching frequency decrease (Frequency Foldback).

When the output power is reduced and we enter DCM mode, the switching frequency decreases down to a value given by the following equation, which is valid down to before entering SKIP mode. This minimum DCM frequency value is dominated by the dead time value, t_{ON} plus t_{DEMAG} being negligible versus t_{DT} that has reached its maximum value $t_{DT,max}$.

$$FSW, DCM, min = \frac{1}{t_{DT,max} + t_{ON} + t_{DEMAG}} \approx \frac{1}{t_{DT,max}} \quad (\text{eq. 1})$$

In order to have, depending on customer application, a different limitation of the maximum switching frequency ($@V_{in}=V_{in,max}$), as well as different V_{ctrl} thresholds for CrM to DCM boundary, different product versions are made available (see Table 2).

CrM–DCM and DCM–CrM Transition Hysteresis

Hesitation of the system to transition between the modes CrM and DCM may have a consequences on inductor current shape and distort the mains current, resulting in a bad PF value when the operating point is at the CrM–DCM boundary.

To avoid such undesired behavior, a 40–mV hysteresis is added on V_{ctrl} threshold. The V_{ctrl} threshold for transitioning

from CrM to DCM mode is named $V_{ctrl,th,*}$ (see Table 6) and the V_{ctrl} threshold for transitioning from DCM to CrM mode is $V_{ctrl,th,*} + 40 \text{ mV}$.

NCP1602 Skip Mode (Active on Versions [B] and [D**], Disabled on Versions [A**] and [C**])**

The circuit also skips cycles when V_{ctrl} decreases towards V_{SKIP-L} threshold. A comparator monitors the V_{ctrl} voltage and inhibits the drive when V_{ctrl} is lower than the SKIP Mode threshold V_{SKIP-L} . Switching resumes when V_{ctrl} exceeds V_{SKIP-H} threshold. The skip mode capability is disabled whenever the PFC stage is not in nominal operation (as dictated by the PFCOK signal – see PFCOK Operation section).

NCP1602 On–time Modulation and V_{TON} Processing Circuit

Let’s analyze the ac line current absorbed by the PFC boost stage. The initial inductor current at the beginning of each switching cycle is always zero. The coil current ramps up when the MOSFET is on. The slope is (V_{in}/L) where L is the coil inductance. At the end of the on–time (t_1), the inductor starts to demagnetize. The inductor current ramps down until it reaches zero. The duration of this phase is (t_2). In some cases, the system enters then the dead–time (t_3) that lasts until the next clock is generated.

One can show that the ac line current is given by:

$$I_{in} = V_{in} \frac{t_1(t_1 + t_2)}{2T L} \quad (\text{eq. 2})$$

Where

$$T = t_1 + t_2 + t_3 \quad (\text{eq. 3})$$

is the switching period and V_{in} is the ac line rectified voltage.

In light of this equation, we immediately note that I_{in} is proportional to V_{in} if $[t_1.(t_1+t_2)/T]$ is a constant.

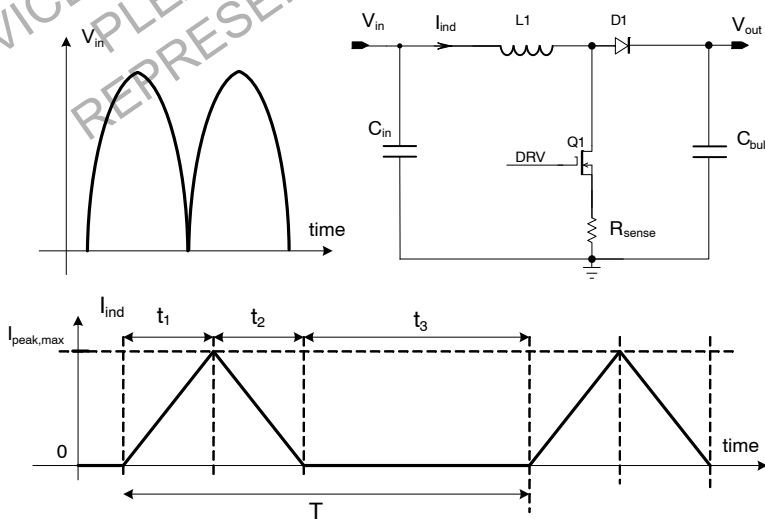

Figure 33. PFC Boost Converter and Inductor Current in DCM

The NCP1602 operates in voltage mode. As portrayed by Figure 33 & Figure 34, the MOSFET on-time t_1 is set by a dedicated circuitry monitoring V_{ctrl} and dead-time t_{DT} ensuring $[t_1.(t_1+t_2)/T]$ is constant and as a result making I_{in} proportional to V_{in} (PF=1)

On-time t_1 is also called t_{on} and its maximum value $t_{on,max}$ is obtained when V_{ctrl} is at maximum level. The internal circuitry makes $t_{on,max}$ at High Line condition (HLINE) to be 3 times the $t_{on,max}$ at Low Line condition (LLINE) (low-pass filtered internal CS-pin voltage is compared to V_{HL} and V_{LL} for deciding whether we are in HLINE or in LLINE). Two other values of $t_{on,max}$ are offered as options.

The input current is then proportional to the input voltage. Hence, the ac line current is properly shaped.

One can note that this analysis is also valid in the CrM case. This condition is just a particular case of this functioning where ($t_3=0$), which leads to ($t_1+t_2=T$) and ($V_{ton}=V_{regul}$). That is why the NCP1602 automatically adapts to the conditions and transitions from DCM and CrM (and vice versa) without power factor degradation and without discontinuity in the power delivery.

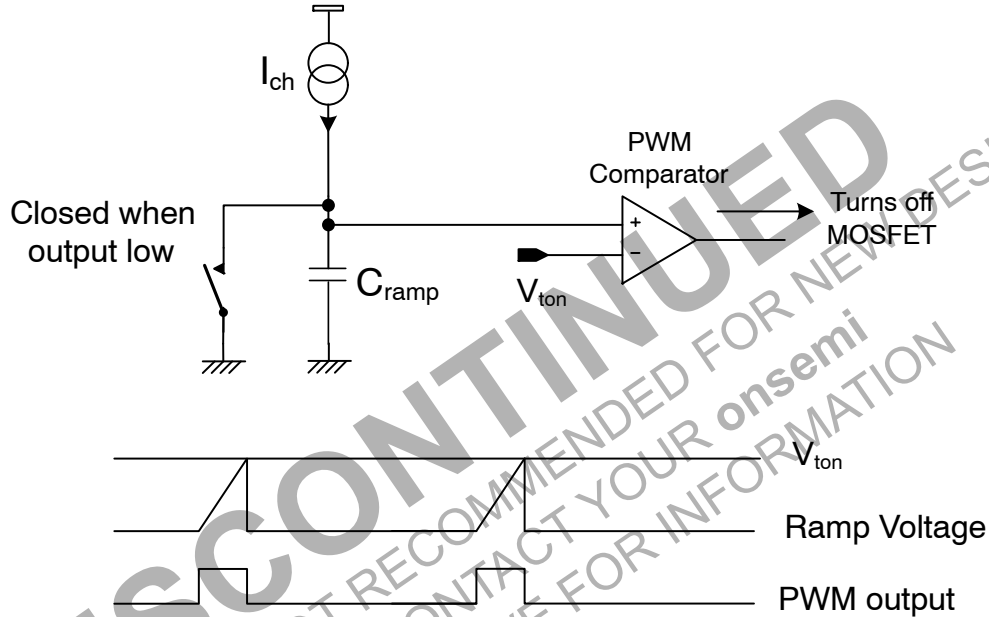

Figure 34. PWM Circuit and Timing Diagram

NCP1602 Regulation Block and Output Voltage Control

A trans-conductance error amplifier (OTA) with access to the inverting input and output is provided. It features a typical trans-conductance gain of 200 μS and a maximum current capability of $\pm 20 \mu A$. The output voltage of the PFC stage is typically scaled down by a resistors divider and monitored by the inverting input (pin FB). Bias current is minimized (less than 500 nA) to allow the use of a high impedance feed-back network. However, it is high enough so that the pin remains in low state if the pin is not connected.

The output of the error amplifier is brought to pin VCTRL for external loop compensation. Typically a type-2 network is applied between pin VCTRL and ground, to set the regulation bandwidth below about 20 Hz and to provide a decent phase boost.

The swing of the error amplifier output is limited within an accurate range:

- It is forced above a voltage drop (V_F) by some circuitry.
- It is clamped not to exceed 4.0 V + the same V_F voltage drop.

The V_F value is 0.5 V typically. The regulated output voltage V_{out} uses a reference voltage $V_{REF} = 2.5 V$

Given the low bandwidth of the regulation loop, abrupt variations of the load, may result in excessive over or under-shoot. Over-shoot is limited by the Over-Voltage Protection connected to FB pin (Feedback).

NCP1602 embeds a “Dynamic Response Enhancer” circuitry (DRE) that contains under-shoots. An internal comparator monitors the FB pin voltage (V_{FB}) and when V_{FB} is lower than 95.5% of its nominal value, it connects a 200- μA current source to speed-up the charge of the compensation network. Effectively this appears as a 10x increase in the loop gain.

The circuit also detects overshoot and immediately reduces the power delivery when the output voltage exceeds 105% of its desired level.

The error amplifier OTA and the OVP, UVP and DRE comparators share the same input information. Based on the typical value of their parameters and if ($V_{out,nom}$) is the output voltage nominal value (e.g., 390 V), we can deduce:

NCP1602

- Output Regulation Level: $V_{out,nom}$
- Output DRE Level: $V_{out,dre} = 95.5\% \times V_{out,nom}$
- Output Soft OVP Level: $V_{out,sovp} = 105\% \times V_{out,nom}$
- Output Fast OVP level: $V_{out,fovp} = 107\% \times V_{out,nom}$

Current Sense and Zero Current Detection

NCP1602 is designed to monitor the current flowing through the power switch during On-time for detecting over current and overstress and to monitor the power MOSFET drain voltage during demagnetization time and dead time in order to generate the ZCD signal.

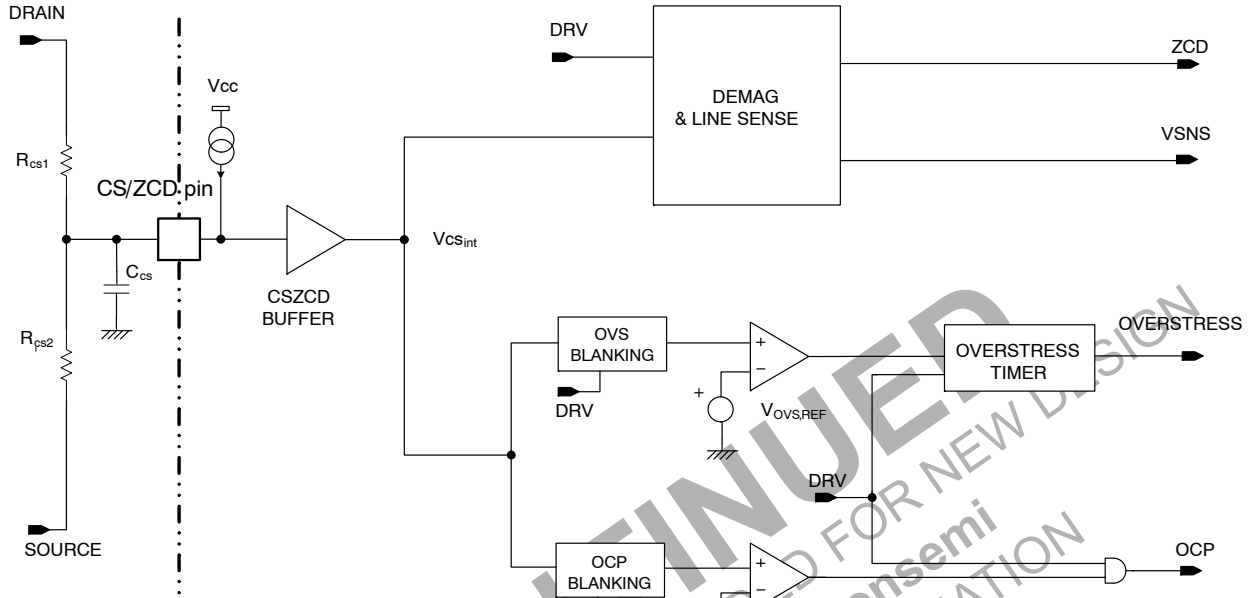

Figure 35. Current Sense, Zero Current Detection Blocks and Vin Sense

Current sense, zero current detection and Vin sense are using the CS/ZCD pin voltage as depicted in the electrical schematic of Figure 35.

Current Sense

The power MOSFET current I is sensed during the T_{ON} phase by the resistor R_{sense} inserted between the MOSFET source and ground (see Figure 36). During T_{ON} phase R_{cs1} and R_{cs2} are almost in parallel and the signal $R_{sense} \cdot I$ is equal to the voltage on pin CS.

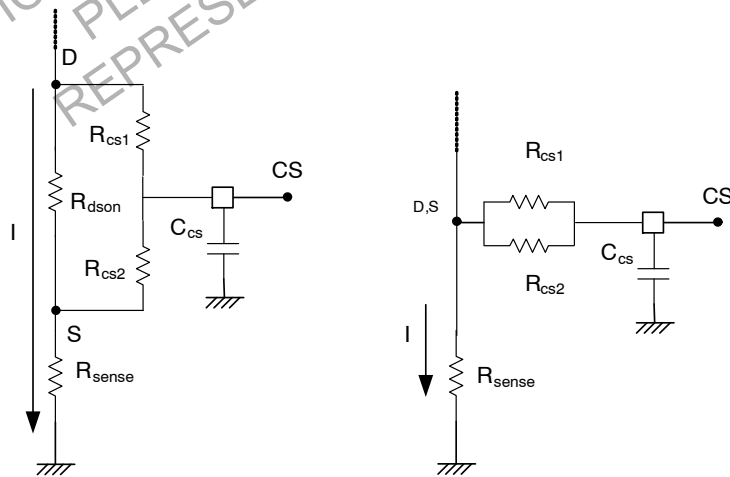

Figure 36. Current Sensing during the T_{ON} Phase

During the On-time and after a 200-ns blanking time, an OCP (Over Current Protection) signal is generated by an OCP comparator, comparing ($V_{CS} = V_{CS2}$) to a 500-mV internal reference.

When $R_{sense} I_{ds_max} = V_{CS} = V_{CS2} = 500$ mV we get:

$$I_{ds_max} = \frac{V_{ocp}}{R_{sense}} \quad (\text{eq. 4})$$

When V_{CS} exceeds the 500-mV internal reference threshold, the OCP signal turns high to reset the PWM latch and forces the driver low. The 200-ns blanking time prevents the OCP comparator from tripping because of the switching spikes that occur when the MOSFET turns on.

Zero Current Detection

The CS pin is also designed to receive, during t_{DEMAG} and t_{DT} , a scaled down (divided by 138) power MOSFET drain voltage that will be used for Zero Current Detection. It may happen that the MOSFET turns on while a huge current flows through the inductor. As an example such a situation can occur at start-up when large in-rush currents charge the bulk capacitor to the line peak voltage. Traditionally, a bypass diode is generally placed between the input and output high-voltage rails to divert this inrush current. If this diode is accidentally shorted, the demagnetization will be impossible and cycle after cycle the inductor current will increase so the MOSFET will also see a high current when it turns on. In both cases, the current can be large enough to trigger the OverStress (OVS) comparator. In this case, the “OverStress” signal goes high and disables the driver for an 800- μ s delay. This long delay leads to a very low duty-ratio operation in case of “OverStress” fault in order to limit the risk of overheating.

When no signal is received that triggers the ZCD comparator to indicate the end of inductor demagnetization, an internal 200- μ s watchdog timer initiates the next drive pulse. At the end of this delay, the circuit senses the CS/ZCD pin impedance to detect a possible grounding of this pin and prevent operation.

Brown-Out Detection (Versions [C**] and [D**])

For an application w/o Vaux (using the Drain) and using Brown-out options ([C**] and [D**]) the Brown-out feature will use the High and Low Brown-out levels.

Brown-out options ([C**] and [D**]) must not be used on an application using Vaux as these options are not designed to work in this case.

By default, the Brown-out flag is set High (BONOK=1), meaning that $V_{in,sensed}$ thru CSZCD pin and V_{SNS} (V_{SNS} is a low-pass filtered scaled down V_{in}) internal signal (see Figure 1), when higher than internal reference voltage V_{BOH} will set the brown-out flag to zero (BONOK=0) and allow the controller to start. After BONOK is set to zero, and switching activity starts, the V_{in} continues to be sensed thru CSZCD pin and when V_{SNS} falls under Brown-out internal reference voltage V_{BOL} for 50 ms, BONOK flag will be set to 1. After BONOK flag will be set to 1, drive is not disabled, instead, a 30- μ A current source is applied to VCTRL pin to gradually reduce V_{ctrl} . As a result, the circuit only stops pulsing when the STATICOVP function is activated (that is when V_{ctrl} reaches the SKIP detection threshold). At that moment, the circuit stops switching. This method limits any risk of false triggering.

For an application w/ Vaux (not using the Drain), Brown-out options ([C] and [D**]) are not be allowed and the UVP will act like a brown-in.** The reason is that before controller starts switching, the V_{out} voltage is equal to $V_{mains,rms}$ and sensed by FB pin and compared to UVP high internal reference voltage V_{UVPH} .

The input of the PFC stage has some impedance that leads to some sag of the input voltage when the input current is large. If the PFC stage suddenly stops while a high current is drawn from the mains, the abrupt decay of the current may make the input voltage rise and the circuit detect a correct line level. Instead, the gradual decrease of $V_{control}$ avoids a line current discontinuity and limits the risk of false triggering.

V_{SNS} internal voltage is also used to sense the line for feed-forward. A similar method is used:

- The V_{SNS} internal pin voltage is compared to a 1.801-V reference.
- If V_{SNS} exceeds 1.801V, the circuit detects a high-line condition and the loop gain is divided by three (the internal PWM ramp slope is three times steeper)
- Once this occurs, if V_{SNS} remains below 1.392 V for 25 ms, the circuit detects a low-line situation (500-mV hysteresis).

At startup, the circuit is in High-line state (“LLINE” Low”) and then V_{SNS} will be used to determine the High-Line or Low-Line state.

The line range detection circuit allows more optimal loop gain control for universal (wide input mains) applications.

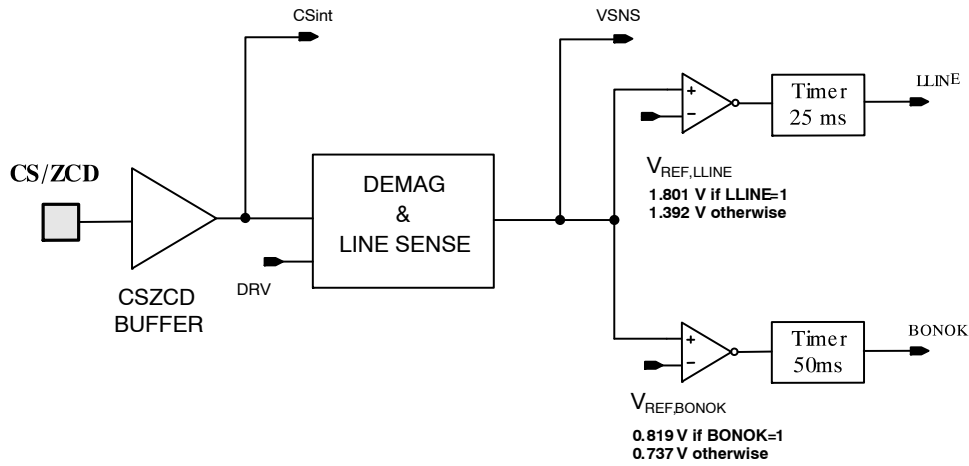

Figure 37. Input Line Sense Monitoring

Thermal Shut-Down (TSD)

An internal thermal circuitry disables the circuit gate drive and keeps the power switch off when the junction temperature exceeds 150°C. The output stage is then enabled once the temperature drops below about 100°C (50°C hysteresis).

The temperature shutdown remains active as long as the circuit is not reset, that is, as long as V_{CC} is higher than a reset threshold.

Output Drive Section

The output stage contains a totem pole optimized to minimize the cross conduction current during high frequency operation. Its high current capability (-500 mA / +800 mA) allows it to effectively drive high gate charge power MOSFET.

Second Over-Voltage Protection

On top of the existing overvoltage protection, a second and redundant overvoltage protection named OVP2 has been added. This overvoltage protection, senses, during t_{DEMAG} the value of V_{out} , thru the R_{CS1} , R_{CS2} divider bridge connected to the pin CS and compares it to an OVP2 voltage reference $V_{REF,OVP2}$. Because it is not possible to adjust the $V_{REF,OVP2}$ reference to R_{fb1} & R_{fb2} that programs the V_{out} value, it has been decided to set $V_{REF,OVP2}$ and R_{CS1} , R_{CS2} in order to get OVP2 triggering for V_{out} voltages much higher than for OVP condition (e.g. OVP2 goes high when V_{out} goes higher than 438 V)

For $V_{out} = 438$ V for OVP2 and given a K_{CS} value equal to $1/138$ ($K_{CS} = R_{CS2} / (R_{CS1} + R_{CS2})$), this gives $V_{REF,OVP2} = 3.175$ V for the threshold voltage to which is compared to the CS voltage during t_{off} . When V_{CS} goes above $V_{REF,OVP2}$ threshold of the OVP2 comparator

(100 mV hysteresis), and after a 1- μ s leading edge blanking time, the OVP2 flag is latched and will stop the switching by resetting the main PWM latch. The OVP2 latch is reset each 800 μ s.

OFF Mode

As previously mentioned, the circuit turns off when one of the following faults is detected:

- Incorrect feeding of the circuit (“UVLO” high when $V_{CC} < V_{CC(off)}$, $V_{CC(off)}$ equating 9 V typically).
- Excessive die temperature detected by the thermal shutdown
- Under-Voltage Protection
- Brown-Out Fault and STATICOVP (see Figure 2)

Generally speaking, the circuit turns off when the conditions are not proper for desired operation. In this mode, the controller stops operating. The major part of the circuit sleeps and its consumption is minimized.

More specifically, when the circuit is in OFF state:

- The drive output is kept low
- All the blocks are off except:
 - ♦ The UVLO circuitry that keeps monitoring the V_{CC} voltage and controlling the start-up current source accordingly.
 - ♦ The TSD (thermal shutdown)
 - ♦ The Under-Voltage Protection (“UVP”)
 - ♦ The brown-out circuitry
- V_{ctrl} is grounded so that when the fault is removed, the device starts-up under the soft start mode.
- The internal “PFCOK” signal is grounded.
- The output of the “ V_{ton} processing block” is grounded

Failure Detection

When manufacturing a power supply, elements can be accidentally shorted or improperly soldered. Such failures can also happen to occur later on because of the components fatigue or excessive stress, soldering defaults or external interactions. In particular, adjacent pins of controllers can be shorted; a pin can be grounded or badly connected. Such open/short situations are generally required not to cause fire, smoke nor big noise. NCP1602 integrate functions that ease meet this requirement. Among them, we can list:

- **Floating feedback pin**
A special internal circuitry detects the floating feedback pin and stops the operation of the IC.
- **Fault of the GND connection**
If the GND pin is not connected, internal circuitry

detects it and if such a fault is detected for 200 μ s, the circuit stops operating.

- **Detection the CS/ZCD pin improper connection**
If the CS/ZCD pin is floating or shorted to GND it is detected by internal circuitry and the circuit stops operating.
- **Boost or bypass diode short**
The controller addresses the short situations of the boost and bypass diodes (a bypass diode is generally placed between the input and output high-voltage rails to divert this inrush current). Practically, the overstress protection is implemented to detect such conditions and forces a low duty-cycle operation until the fault is gone.

Refer to application note ANDxxxx for more details.

DISCONTINUED
THIS DEVICE IS NOT RECOMMENDED FOR NEW DESIGN
PLEASE CONTACT YOUR onsemi
REPRESENTATIVE FOR INFORMATION

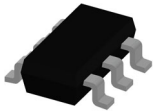

TSOP-6 3.00x1.50x0.90, 0.95P
CASE 318G
ISSUE W

DATE 26 FEB 2024

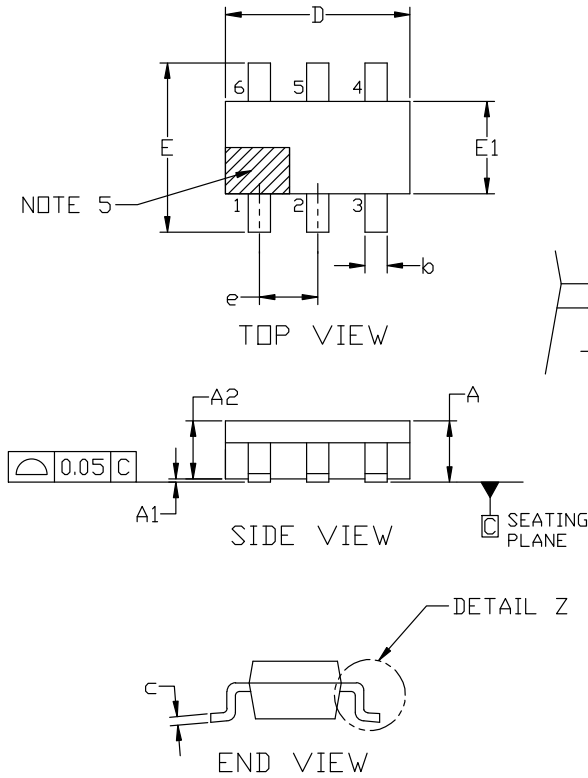

NOTES:

1. DIMENSIONING AND TOLERANCING PER ASME Y14.5M, 2018.
2. CONTROLLING DIMENSION: MILLIMETERS.
3. MAXIMUM LEAD THICKNESS INCLUDES LEAD FINISH. MINIMUM LEAD THICKNESS IS THE MINIMUM THICKNESS OF BASE MATERIAL.
4. DIMENSIONS D AND E1 DO NOT INCLUDE MOLD FLASH, PROTRUSIONS, OR GATE BURRS. MOLD FLASH, PROTRUSIONS, OR GATE BURRS SHALL NOT EXCEED 0.15 PER SIDE. DIMENSIONS D AND E1 ARE DETERMINED AT DATUM H.
5. PIN 1 INDICATOR MUST BE LOCATED IN THE INDICATED ZONE

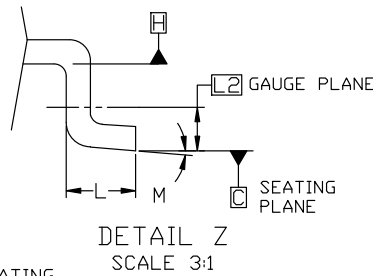

MILLIMETERS			
DIM	MIN	NOM	MAX
A	0.90	1.00	1.10
A1	0.01	0.06	0.10
A2	0.80	0.90	1.00
b	0.25	0.38	0.50
c	0.10	0.18	0.26
D	2.90	3.00	3.10
E	2.50	2.75	3.00
E1	1.30	1.50	1.70
e	0.85	0.95	1.05
L	0.20	0.40	0.60
L2	0.25 BSC		
M	0°	---	10°

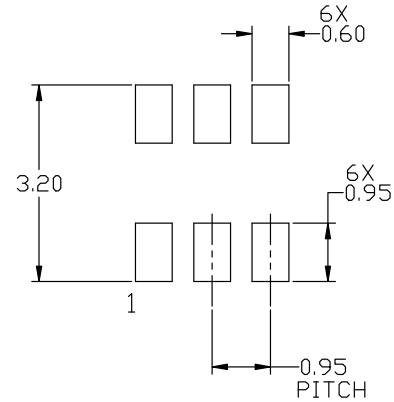

RECOMMENDED MOUNTING FOOTPRINT

*For additional information on our Pb-Free strategy and soldering details, please download the ON Semiconductor Soldering and Mounting Techniques Reference manual, SOLDERRM/D.

DOCUMENT NUMBER:	98ASB14888C	Electronic versions are uncontrolled except when accessed directly from the Document Repository. Printed versions are uncontrolled except when stamped "CONTROLLED COPY" in red.
DESCRIPTION:	TSOP-6 3.00x1.50x0.90, 0.95P	PAGE 1 OF 2

onsemi and ONSEMI are trademarks of Semiconductor Components Industries, LLC dba onsemi or its subsidiaries in the United States and/or other countries. onsemi reserves the right to make changes without further notice to any products herein. onsemi makes no warranty, representation or guarantee regarding the suitability of its products for any particular purpose, nor does onsemi assume any liability arising out of the application or use of any product or circuit, and specifically disclaims any and all liability, including without limitation special, consequential or incidental damages. onsemi does not convey any license under its patent rights nor the rights of others.

TSOP-6 3.00x1.50x0.90, 0.95P
CASE 318G
ISSUE W

DATE 26 FEB 2024

**GENERIC
MARKING DIAGRAM***

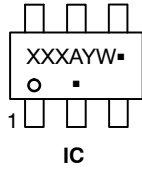

IC

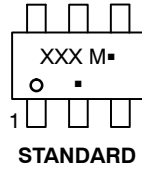

STANDARD

XXX = Specific Device Code	XXX = Specific Device Code
A = Assembly Location	M = Date Code
Y = Year	▪ = Pb-Free Package
W = Work Week	
▪ = Pb-Free Package	

*This information is generic. Please refer to device data sheet for actual part marking. Pb-Free indicator, "G" or microdot "▪", may or may not be present. Some products may not follow the Generic Marking.

- | | | | | | |
|--|--|---|---|---|--|
| STYLE 1:
PIN 1. DRAIN
2. DRAIN
3. GATE
4. SOURCE
5. DRAIN
6. DRAIN | STYLE 2:
PIN 1. EMITTER 2
2. BASE 1
3. COLLECTOR 1
4. EMITTER 1
5. BASE 2
6. COLLECTOR 2 | STYLE 3:
PIN 1. ENABLE
2. N/C
3. R BOOST
4. Vz
5. V in
6. V out | STYLE 4:
PIN 1. N/C
2. V in
3. NOT USED
4. GROUND
5. ENABLE
6. LOAD | STYLE 5:
PIN 1. EMITTER 2
2. BASE 2
3. COLLECTOR 1
4. EMITTER 1
5. BASE 1
6. COLLECTOR 2 | STYLE 6:
PIN 1. COLLECTOR
2. COLLECTOR
3. BASE
4. EMITTER
5. COLLECTOR
6. COLLECTOR |
| STYLE 7:
PIN 1. COLLECTOR
2. COLLECTOR
3. BASE
4. N/C
5. COLLECTOR
6. EMITTER | STYLE 8:
PIN 1. Vbus
2. D(in)
3. D(in)+
4. D(out)+
5. D(out)
6. GND | STYLE 9:
PIN 1. LOW VOLTAGE GATE
2. DRAIN
3. SOURCE
4. DRAIN
5. DRAIN
6. HIGH VOLTAGE GATE | STYLE 10:
PIN 1. D(OUT)+
2. GND
3. D(OUT)-
4. D(IN)-
5. VBUS
6. D(IN)+ | STYLE 11:
PIN 1. SOURCE 1
2. DRAIN 2
3. DRAIN 2
4. SOURCE 2
5. GATE 1
6. DRAIN 1/GATE 2 | STYLE 12:
PIN 1. I/O
2. GROUND
3. I/O
4. I/O
5. VCC
6. I/O |
| STYLE 13:
PIN 1. GATE 1
2. SOURCE 2
3. GATE 2
4. DRAIN 2
5. SOURCE 1
6. DRAIN 1 | STYLE 14:
PIN 1. ANODE
2. SOURCE
3. GATE
4. CATHODE/DRAIN
5. CATHODE/DRAIN
6. CATHODE/DRAIN | STYLE 15:
PIN 1. ANODE
2. SOURCE
3. GATE
4. DRAIN
5. N/C
6. CATHODE | STYLE 16:
PIN 1. ANODE/CATHODE
2. BASE
3. EMITTER
4. COLLECTOR
5. ANODE
6. CATHODE | STYLE 17:
PIN 1. EMITTER
2. BASE
3. ANODE/CATHODE
4. ANODE
5. CATHODE
6. COLLECTOR | |

DOCUMENT NUMBER:	98ASB14888C	Electronic versions are uncontrolled except when accessed directly from the Document Repository. Printed versions are uncontrolled except when stamped "CONTROLLED COPY" in red.
DESCRIPTION:	TSOP-6 3.00x1.50x0.90, 0.95P	PAGE 2 OF 2

onsemi and **ONSEMI** are trademarks of Semiconductor Components Industries, LLC dba **onsemi** or its subsidiaries in the United States and/or other countries. **onsemi** reserves the right to make changes without further notice to any products herein. **onsemi** makes no warranty, representation or guarantee regarding the suitability of its products for any particular purpose, nor does **onsemi** assume any liability arising out of the application or use of any product or circuit, and specifically disclaims any and all liability, including without limitation special, consequential or incidental damages. **onsemi** does not convey any license under its patent rights nor the rights of others.

onsemi, **Onsemi**, and other names, marks, and brands are registered and/or common law trademarks of Semiconductor Components Industries, LLC dba "**onsemi**" or its affiliates and/or subsidiaries in the United States and/or other countries. **onsemi** owns the rights to a number of patents, trademarks, copyrights, trade secrets, and other intellectual property. A listing of **onsemi**'s product/patent coverage may be accessed at www.onsemi.com/site/pdf/Patent-Marking.pdf. **onsemi** reserves the right to make changes at any time to any products or information herein, without notice. The information herein is provided "as-is" and **onsemi** makes no warranty, representation or guarantee regarding the accuracy of the information, product features, availability, functionality, or suitability of its products for any particular purpose, nor does **onsemi** assume any liability arising out of the application or use of any product or circuit, and specifically disclaims any and all liability, including without limitation special, consequential or incidental damages. Buyer is responsible for its products and applications using **onsemi** products, including compliance with all laws, regulations and safety requirements or standards, regardless of any support or applications information provided by **onsemi**. "Typical" parameters which may be provided in **onsemi** data sheets and/or specifications can and do vary in different applications and actual performance may vary over time. All operating parameters, including "Typicals" must be validated for each customer application by customer's technical experts. **onsemi** does not convey any license under any of its intellectual property rights nor the rights of others. **onsemi** products are not designed, intended, or authorized for use as a critical component in life support systems or any FDA Class 3 medical devices or medical devices with a same or similar classification in a foreign jurisdiction or any devices intended for implantation in the human body. Should Buyer purchase or use **onsemi** products for any such unintended or unauthorized application, Buyer shall indemnify and hold **onsemi** and its officers, employees, subsidiaries, affiliates, and distributors harmless against all claims, costs, damages, and expenses, and reasonable attorney fees arising out of, directly or indirectly, any claim of personal injury or death associated with such unintended or unauthorized use, even if such claim alleges that **onsemi** was negligent regarding the design or manufacture of the part. **onsemi** is an Equal Opportunity/Affirmative Action Employer. This literature is subject to all applicable copyright laws and is not for resale in any manner.

ADDITIONAL INFORMATION

TECHNICAL PUBLICATIONS:

Technical Library: www.onsemi.com/design/resources/technical-documentation
onsemi Website: www.onsemi.com

ONLINE SUPPORT: www.onsemi.com/support

For additional information, please contact your local Sales Representative at www.onsemi.com/support/sales