

CAT3606

6-Channel Low Noise Charge Pump White LED Driver

Description

The CAT3606 controls up to four LEDs for the main display and two LEDs for the sub-display in cellular phones. The device is capable of operating in either 1x (LDO) mode or 1.5x charge pump mode. All LED pin currents are regulated and tightly matched to achieve uniformity of brightness across the LCD backlight. An external resistor (R_{SET}) sets the nominal output current.

The device can deliver as much as 20 mA per channel during low voltage operation (3 V), and 30 mA per channel during nominal operation (3.3 V). A constant high-frequency switching scheme (1 MHz) provides low noise and allows the use of very small value ceramic capacitors.

A “zero” quiescent current mode can be achieved via the chip enable pin EN. The Main and Sub LEDs each have their own dedicated ON/OFF control pins ENM, ENS. Dimming can be achieved using either a DC voltage to control the R_{SET} pin current, or by applying a PWM signal on the \bar{ENM} and \bar{ENS} pins.

The device is available in a 16-pad TQFN package with a max height of 0.8 mm.

Features

- Drives up to 4 Main LEDs and 2 Sub LEDs
- Separate Control for Main and Sub LEDs
- Compatible with Supply Voltage of 3 V to 5.5 V
- Power Efficiency up to 90%
- Output Current up to 30 mA per LED
- High-frequency Operation at 1 MHz
- 2 Modes of Operation 1x and 1.5x
- White LED Detect Circuitry on All Channels
- Shutdown Current less than 1 μ A
- Small Ceramic Capacitors
- Soft Start and Current Limiting
- Short Circuit Protection
- 16-pad TQFN Package, 0.8 mm Max Height
- These Devices are Pb-Free, Halogen Free/BFR Free and are RoHS Compliant

Applications

- Cell Phone Main and Sub-display Backlight
- Navigation
- PDAs
- Digital Cameras



ON Semiconductor®

<http://onsemi.com>



TQFN-16
HV4 SUFFIX
CASE 510AE

PIN CONNECTIONS (Note 1)

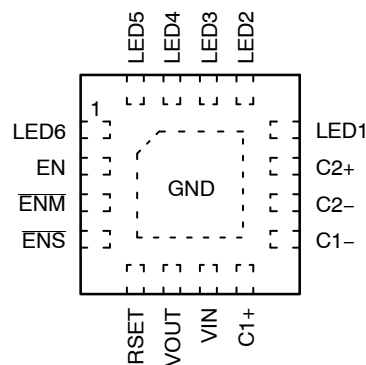

(4 x 4 mm) (Top View)

MARKING DIAGRAMS



G366 = CAT3606HV4-T2
CDBB = CAT3606HV4-GT2

ORDERING INFORMATION

Device	Package	Shipping
CAT3606HV4-T2	TQFN-16 (Note 2)	2,000/ Tape & Reel
CAT3606HV4-GT2	TQFN-16 (Note 3)	

1. The “exposed pad” under the package must be connected to the ground plane on the PCB.
2. Matte-Tin Plated Finish (RoHS-compliant).
3. NiPdAu Plated Finish (RoHS-compliant).

CAT3606

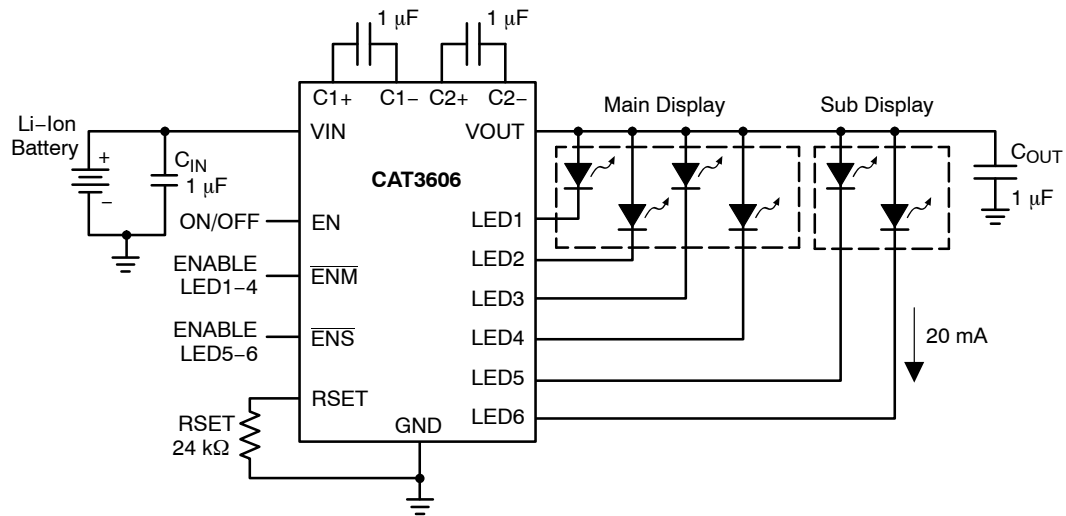

Figure 1. Typical Application Circuit

Table 1. PIN DESCRIPTION

Pin #	Name	Function
1	LED6	LED6 cathode terminal
2	EN	Enable/shutdown input, active high
3	ENM	Enable "main" input for LED1 to LED4, active low
4	ENS	Enable "sub" input for LED5 and LED6, active low
5	RSET	The LED output current is set by the current sourced out of the RSET pin
6	VOUT	Charge pump output connected to the LED anodes
7	VIN	Supply voltage
8	C1+	Bucket capacitor 1 terminal
9	C1-	Bucket capacitor 1 terminal
10	C2-	Bucket capacitor 2 terminal
11	C2+	Bucket capacitor 2 terminal
12	LED1	LED 1 cathode terminal
13	LED2	LED 2 cathode terminal
14	LED3	LED 3 cathode terminal
15	LED4	LED 4 cathode terminal
16	LED5	LED 5 cathode terminal
PAD	GND	Ground reference

CAT3606

Table 2. ABSOLUTE MAXIMUM RATINGS

Parameter	Rating	Unit
VIN, VOUT, LEDx voltage	-0.3 to 7.0	V
EN, ENM, ENS voltage	-0.3 to VIN	V
RSET voltage	-0.3 to VIN	V
RSET current	±1	mA
Ambient Temperature Range	-40 to +85	°C
Storage Temperature Range	-65 to +160	°C
Lead Temperature	300	°C
ESD Rating HBM (Human Body Model)	2,000	V
ESD Rating MM (Machine Model) (Note 4)	200	V

Stresses exceeding Maximum Ratings may damage the device. Maximum Ratings are stress ratings only. Functional operation above the Recommended Operating Conditions is not implied. Extended exposure to stresses above the Recommended Operating Conditions may affect device reliability.

4. Machine model is with 200 pF capacitor discharged directly into each pin.

Table 3. RECOMMENDED OPERATING CONDITIONS

Parameter	Range	Unit
VIN	3.0 to 5.5	V
Ambient Temperature Range	-40 to +85	°C
Input/Output/Bucket Capacitors	1 ±20% Typical	µF
I _{LED} per LED pin	0 to 30	mA
I _{OUT} Total Output Current	0 to 150	mA

Table 4. ELECTRICAL OPERATING CHARACTERISTICS

(Limits over recommended operating conditions unless specified otherwise. Typical values at T_A = 25°C, V_{IN} = 3.5 V, I_{RSET} = 5 µA.)

Symbol	Parameter	Conditions	Min	Typ	Max	Unit
I _Q	Quiescent Current	V _{EN} = 0 V		0.1	1	µA
		1x Mode, No Load		0.3	1	mA
		1.5x Mode, No Load		2.6	5	mA
V _{RSET}	RSET Regulated Voltage		1.17	1.2	1.23	V
I _{LED}	Programmed LED Current	I _{RSET} = 5 µA		2.4		mA
		I _{RSET} = 37 µA		15.0		
		I _{RSET} = 78 µA		30.0		
I _{LED}	LED Current Range with 6 LEDs	3.3 ≤ V _{IN} ≤ 4.5 V			30	mA
		3.0 ≤ V _{IN} ≤ 4.5 V			20	
I _{LED}	LED Current Range with 4 LEDs	3.3 ≤ V _{IN} ≤ 4.5 V			30	mA
I _{LED-ACC}	LED Current Accuracy	0.5 mA ≤ I _{LED} ≤ 3 mA		±15		%
		3 mA ≤ I _{LED} ≤ 30 mA		±5		
I _{LED-DEV}	LED Channel Matching	(I _{LED} - I _{LEDAVG}) / I _{LEDAVG}		±3		%
R _{OUT}	Output Resistance (Open Loop)	1x Mode,		1.4	2.5	Ω
		1.5x Mode, I _{OUT} = 100 mA		6.5	10	
f _{OSC}	Charge Pump Frequency		0.8	1.0	1.3	MHz
T _{DROPOUT}	1x to 1.5x Mode Transition Dropout Delay		0.4	0.6	0.9	ms
I _{EN-CTR}	Input Leakage Current	On Inputs EN, ENM, ENS			1	µA
V _{EN-CTR}	High Detect Threshold Low Detect Threshold	On Inputs EN, ENM, ENS		0.8	1.3	V
			0.4	0.7		
I _{SC}	Input Current Limit	V _{OUT} = GND	30	45	60	mA
I _{LIM}	Maximum Input Current	V _{OUT} > 1 V	200	400	600	mA

CAT3606

Block Diagram

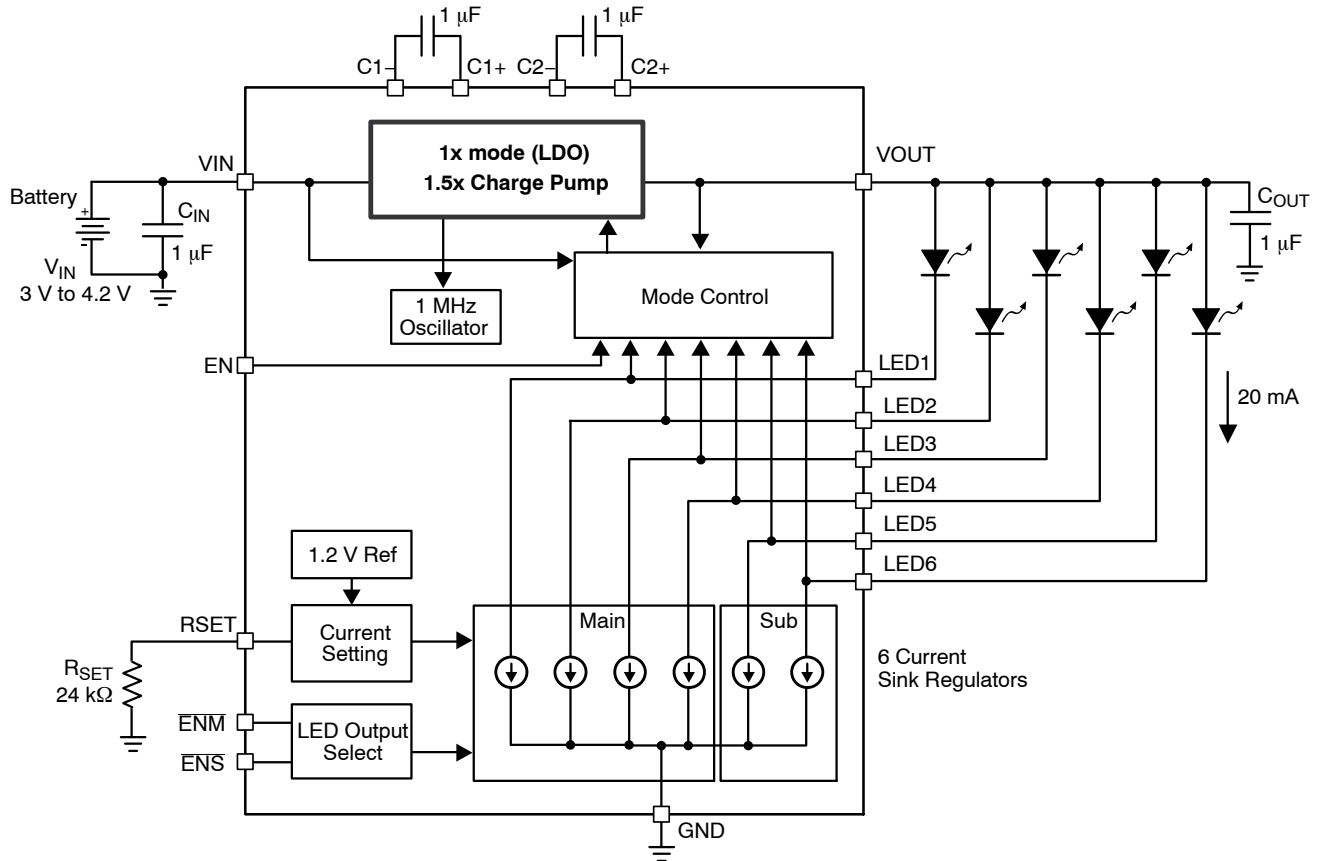

Figure 2. CAT3606 Functional Block Diagram

Basic Operation

At power-up, the CAT3606 starts operation in 1x mode. If it is able to drive the programmed LED current, it continues in 1x mode. If the battery voltage drops to a level where the LED current cannot be met, the driver automatically switches into 1.5x mode, to boost the output voltage high enough to achieve the nominal LED current.

The above sequence is reinitialized each and every time the chip is powered up or is taken out of shutdown mode (via EN pin). The use of the Main and Sub display enable pins ($\overline{\text{ENM}}$ or $\overline{\text{ENS}}$) does not affect the mode of operation.

LED Current Setting

The LED current is set by the external resistor R_{SET} connected between the RSET pin and ground. Table 5 lists various LED currents and the associated R_{SET} resistor value for standard 1% precision surface mount resistors.

Table 5. RSET Resistor Selection

LED Current (mA)	R_{SET} (k Ω)
1	649
2	287
5	102
10	49.9
15	32.4
20	23.7
30	15.4

The enable lines $\overline{\text{ENM}}$ and $\overline{\text{ENS}}$ allow to turn On or Off a group of LEDs as shown in Table 6.

Table 6. LED Selection

Control Lines			LED Outputs	
EN	$\overline{\text{ENM}}$	$\overline{\text{ENS}}$	Main LED1 - LED4	Sub LED5 - LED6
0	X	X	-	-
1	1	1	-	-
1	0	1	ON	-
1	1	0	-	ON
1	0	0	ON	ON

NOTES: 1 = logic high (or VIN)
 0 = logic low (or GND)
 - = LED output OFF
 X = don't care

The unused LED channels can also be turned off by connecting the respective LED pins to VOUT. In which case, the corresponding LED driver is disabled and the typical LED sink current is only about 0.2 mA. When the following equation is true on any channel, the driver turns off the LED channel:

$$V_{\text{OUT}} - V_{\text{LED}} \leq 1 \text{ V (LED channel OFF)}$$

Note: The CAT3606 is designed to drive LEDs with forward voltage greater than 1 V and is not compatible with resistive loads.

TYPICAL CHARACTERISTICS

($V_{IN} = 3.6\text{ V}$, $EN = V_{IN}$, $\overline{ENM} = \overline{ENS} = GND$, $C_{IN} = C_{OUT} = 1\ \mu\text{F}$, $R_{SET} = 24\ \text{k}\Omega$ (20 mA per LED), $T_{AMB} = 25^\circ\text{C}$, unless otherwise specified.)

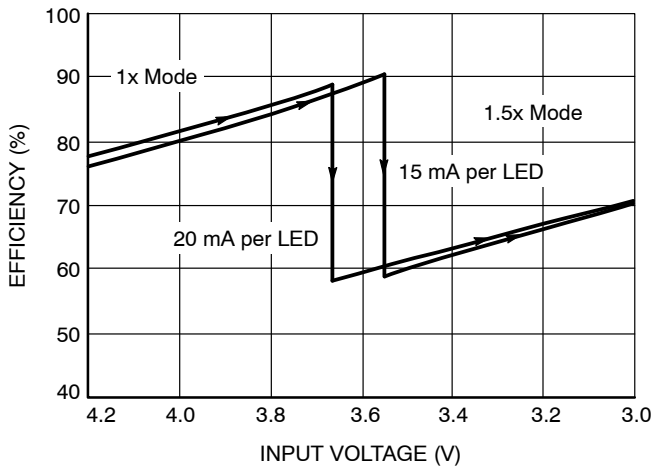

Figure 3. Efficiency vs. Input Voltage (6 LEDs)

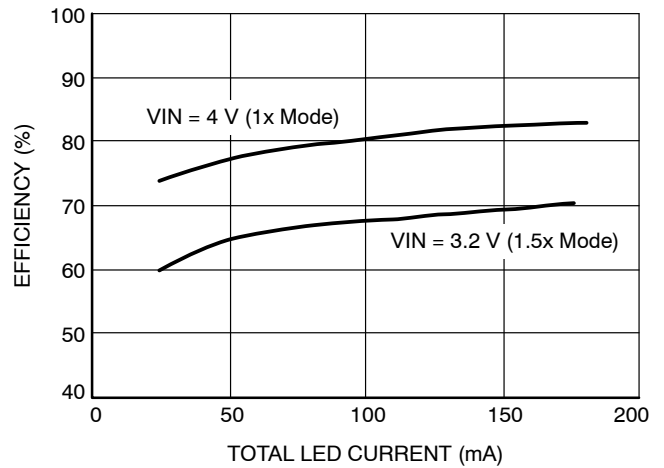

Figure 4. Efficiency vs. Total LED Current (6 LEDs)

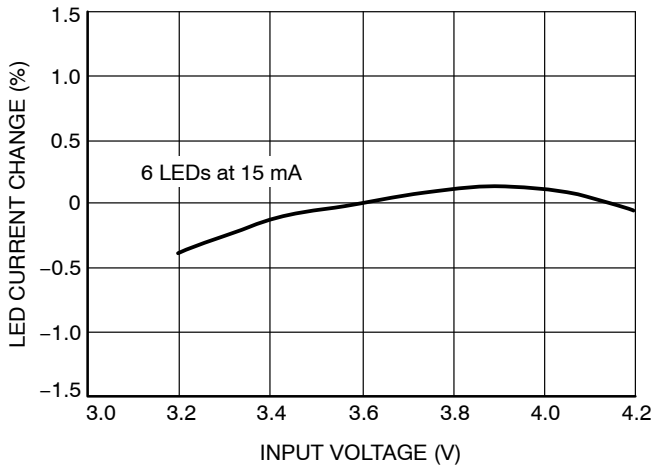

Figure 5. LED Current vs. Input Voltage

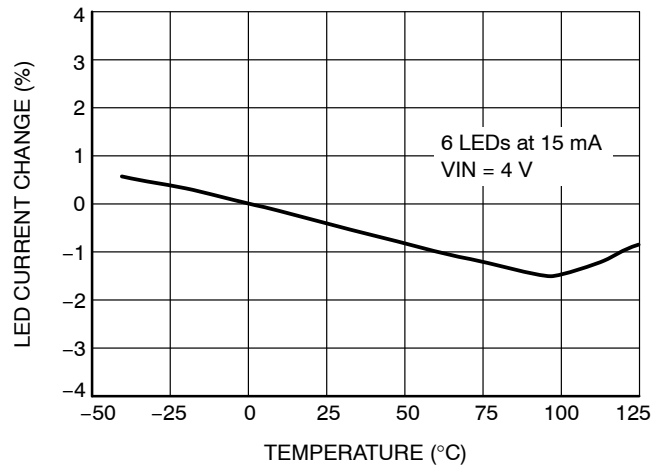

Figure 6. LED Current Change vs. Temperature

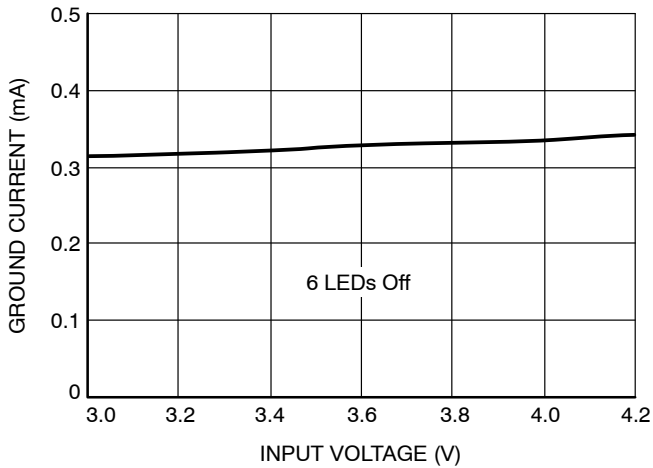

Figure 7. Ground Current vs. Input Voltage (1x Mode)

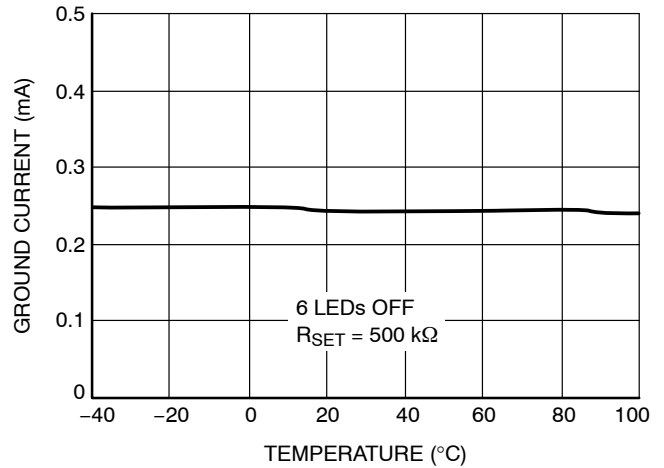

Figure 8. Ground Current vs. Temperature (1x Mode)

CAT3606

TYPICAL CHARACTERISTICS

($V_{IN} = 3.6\text{ V}$, $EN = V_{IN}$, $\overline{ENM} = \overline{ENS} = \text{GND}$, $C_{IN} = C_{OUT} = 1\ \mu\text{F}$, $R_{SET} = 24\ \text{k}\Omega$ (20 mA per LED), $T_{AMB} = 25^\circ\text{C}$, unless otherwise specified.)

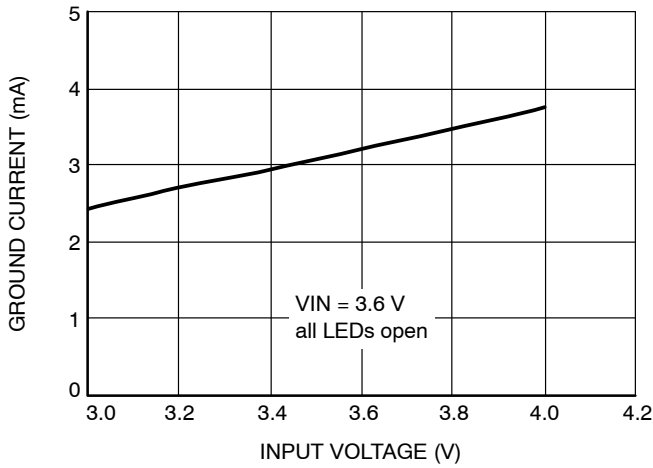

Figure 9. Ground Current vs. Input Voltage (1.5x Mode)

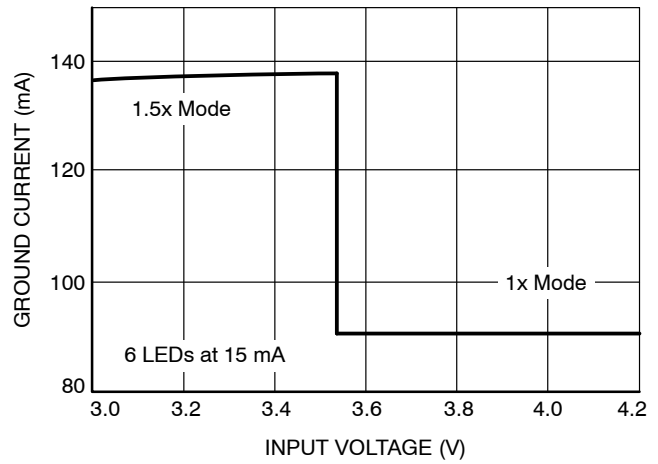

Figure 10. Supply Current vs. Input Voltage

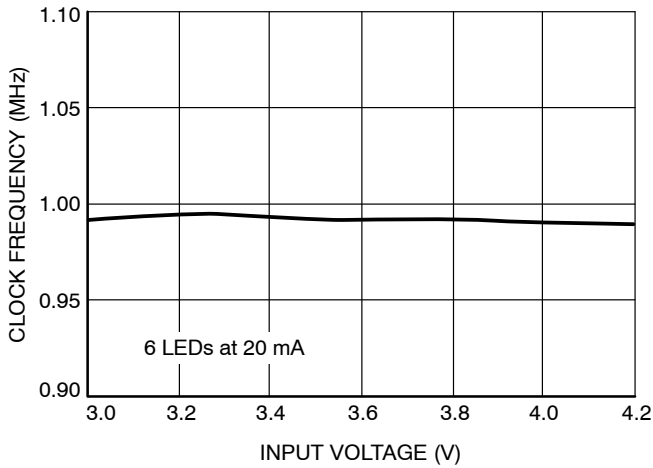

Figure 11. Oscillator Frequency vs. Input Voltage

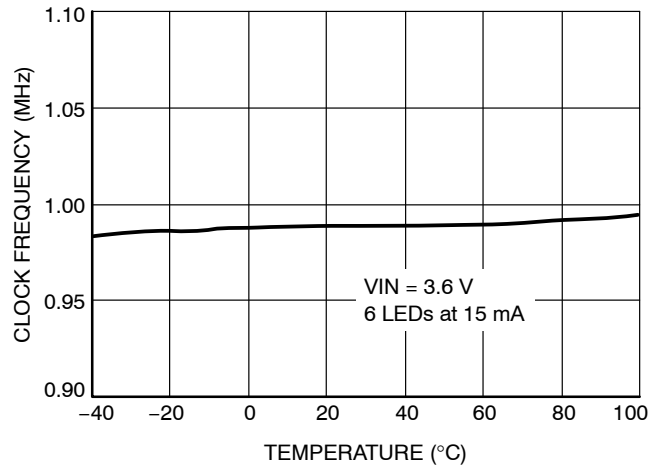

Figure 12. Oscillator Frequency vs. Temperature

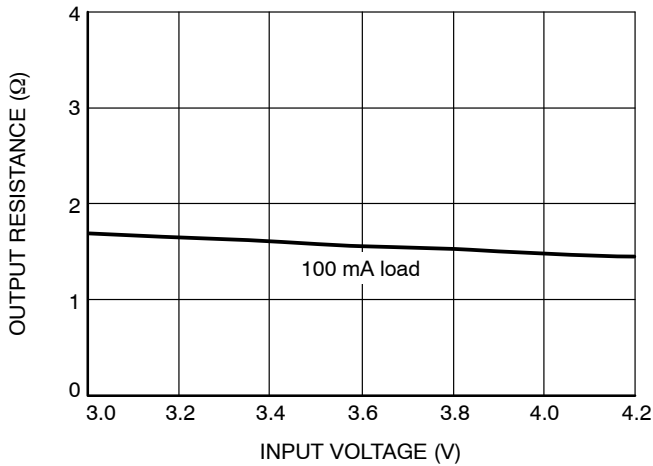

Figure 13. Output Resistance vs. Input Voltage (1x Mode)

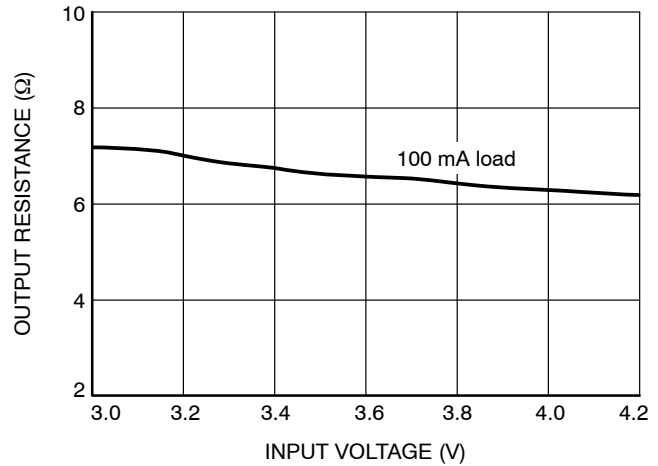

Figure 14. Output Resistance vs. Input Voltage (1.5x Mode)

CAT3606

TYPICAL CHARACTERISTICS

($V_{IN} = 3.6\text{ V}$, $EN = V_{IN}$, $\overline{ENM} = \overline{ENS} = \text{GND}$, $C_{IN} = C_{OUT} = 1\ \mu\text{F}$, $R_{SET} = 24\ \text{k}\Omega$ (20 mA per LED), $T_{AMB} = 25^\circ\text{C}$, unless otherwise specified.)

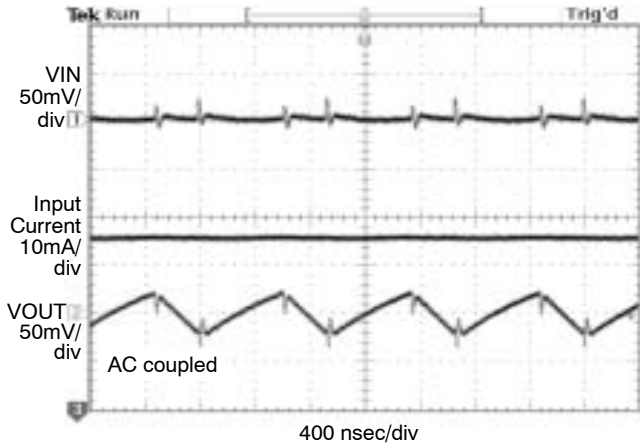

Figure 15. Switching Waveforms in 1.5x Mode

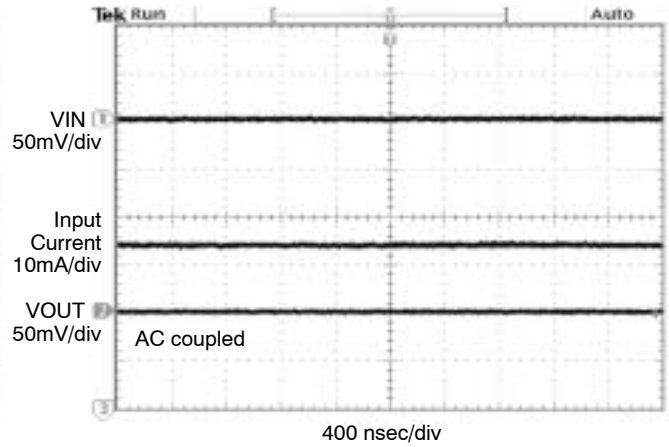

Figure 16. Operating Waveforms in 1x Mode

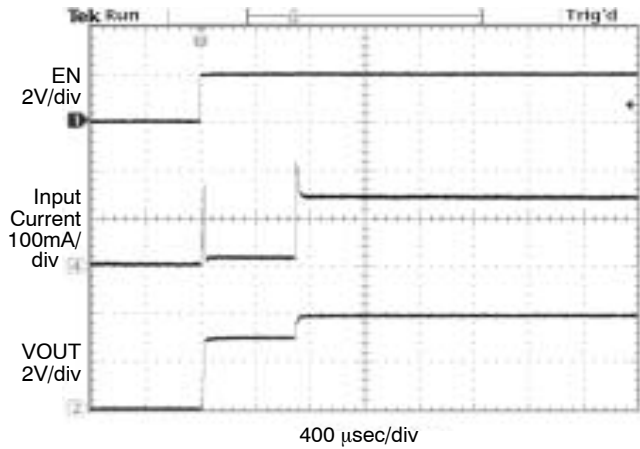

Figure 17. Power Up 6 LEDs at 15 mA, $V_{IN} = 3\text{ V}$ (1.5x Mode)

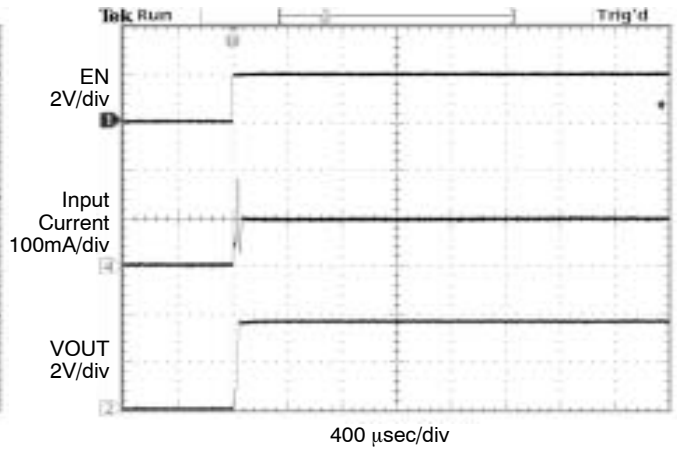

Figure 18. Power Up 6 LEDs at 15 mA, $V_{IN} = 3.6\text{ V}$ (1x Mode)

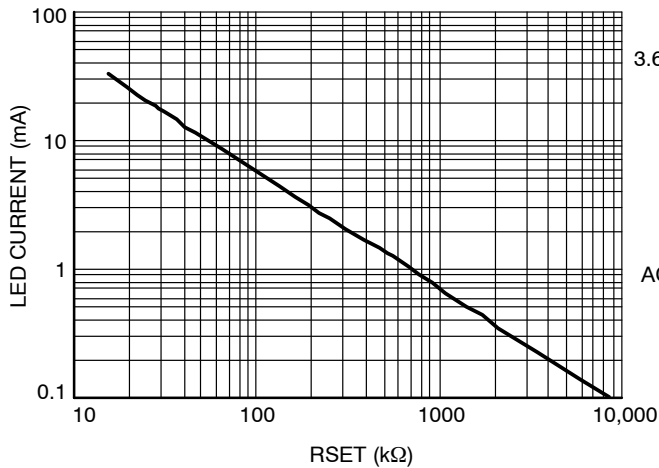

Figure 19. LED Current vs. R_{SET}

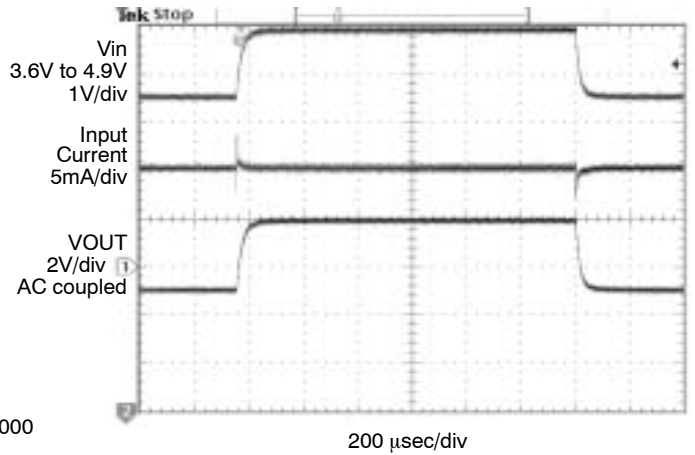

Figure 20. Line Transient Response in 1x Mode

CAT3606

TYPICAL CHARACTERISTICS

($V_{IN} = 3.6\text{ V}$, $EN = V_{IN}$, $\overline{ENM} = \overline{ENS} = \text{GND}$, $C_{IN} = C_{OUT} = 1\ \mu\text{F}$, $T_{AMB} = 25^\circ\text{C}$, unless otherwise specified.)

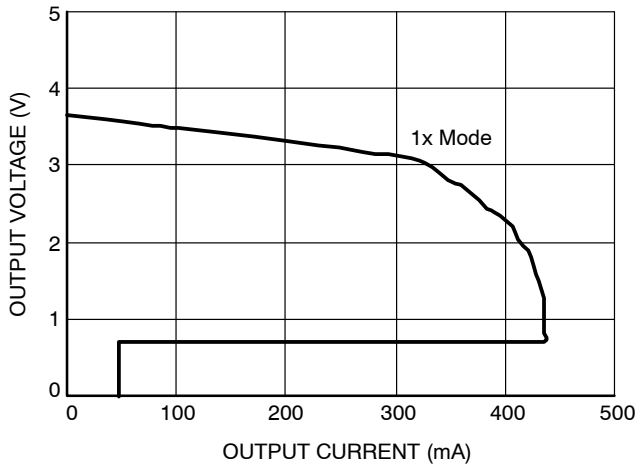

Figure 21. Foldback Current Limiting

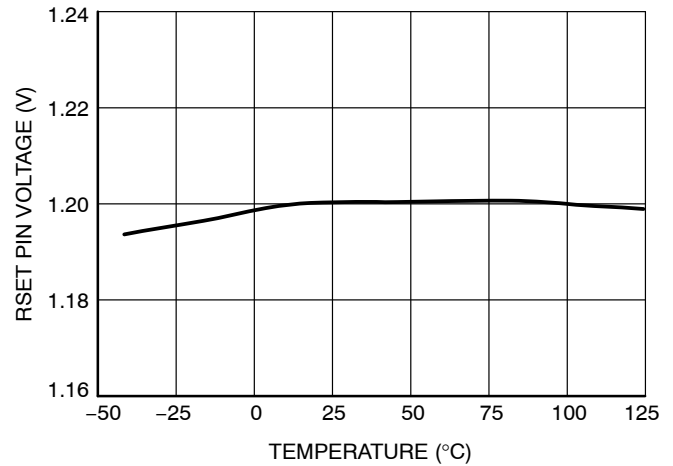

Figure 22. RSET Pin Voltage vs. Temperature

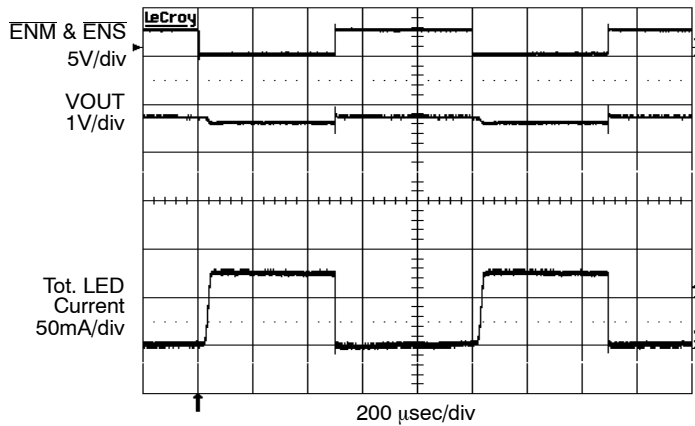

Figure 23. PWM Dimming at 1 kHz on \overline{ENM} and \overline{ENS}

Recommended Layout

When the driver is in the 1.5x charge pump mode, the 1 MHz switching frequency operation requires to minimize trace length and impedance to ground on all 4 capacitors. A ground plane should cover the area on the bottom side of the PCB opposite to the IC and the bypass capacitors. Capacitors C_{in} and C_{out} require short connection to ground which can be done with multiple vias as shown on Figure 24. A square copper area matches the QFN16 exposed pad (GND) and must be connected to the ground plane underneath. The use of multiple via will improve the heat dissipation.

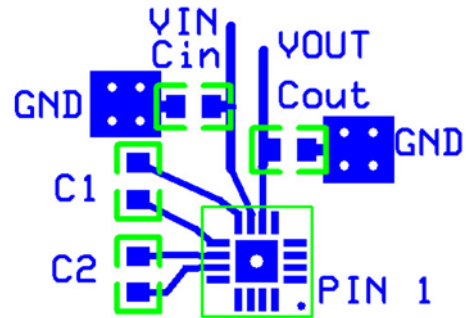
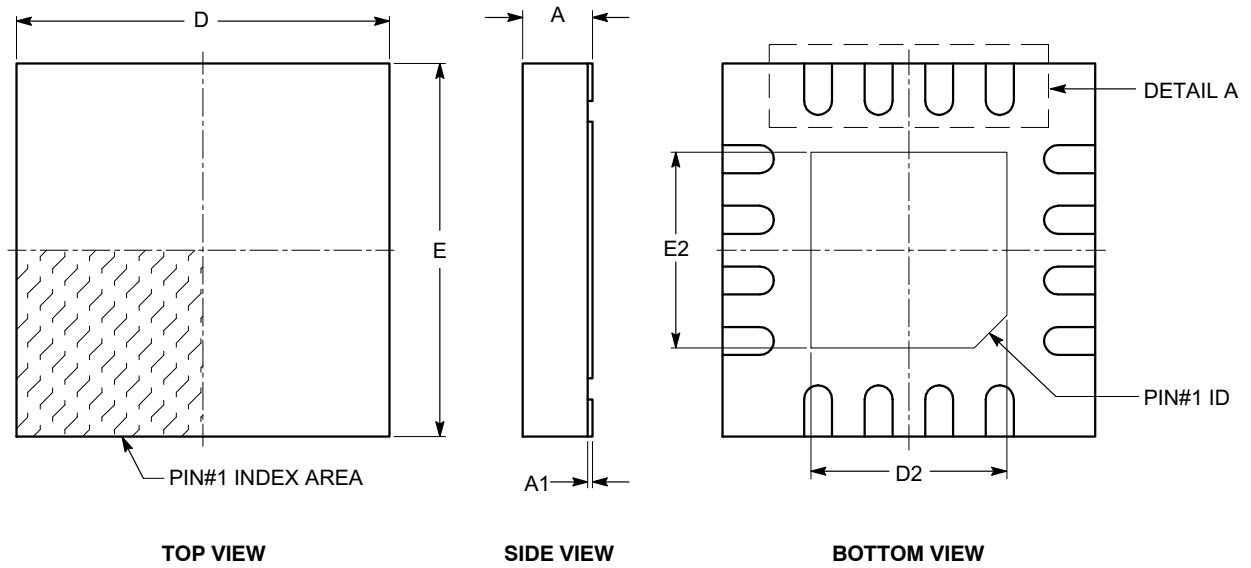

Figure 24. PCB Layout

CAT3606

PACKAGE DIMENSIONS

TQFN16, 4x4
CASE 510AE-01
ISSUE A



SYMBOL	MIN	NOM	MAX
A	0.70	0.75	0.80
A1	0.00	0.02	0.05
A3	0.20 REF		
b	0.25	0.30	0.35
D	3.90	4.00	4.10
D2	2.00	---	2.25
E	3.90	4.00	4.10
E2	2.00	---	2.25
e	0.65 BSC		
L	0.45	---	0.65

Notes:

- (1) All dimensions are in millimeters.
- (2) Complies with JEDEC MO-220.

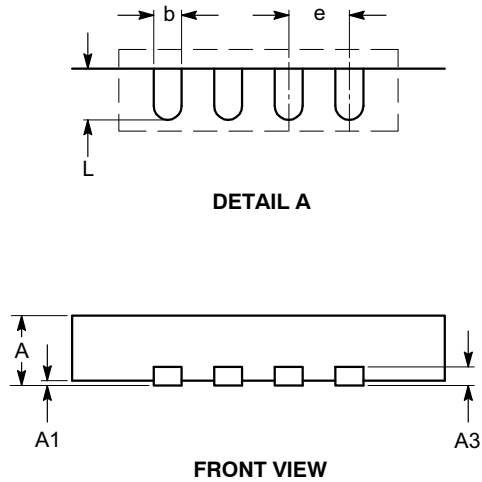

TQFN16, 4x4
CASE 510AE
ISSUE A

DATE 18 MAR 2009

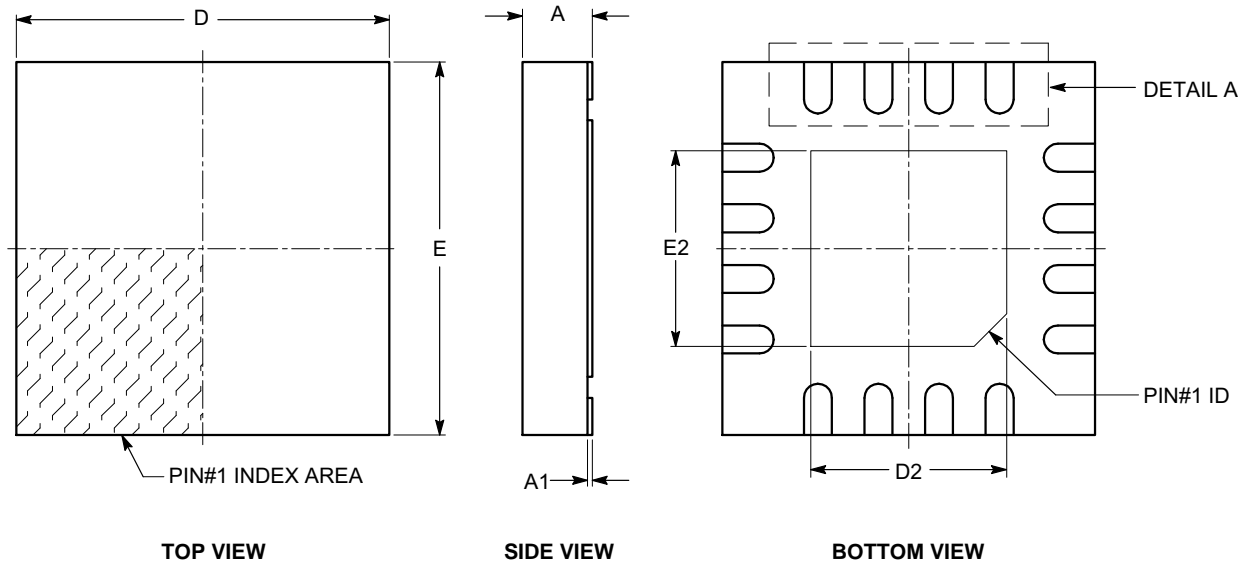

SYMBOL	MIN	NOM	MAX
A	0.70	0.75	0.80
A1	0.00	0.02	0.05
A3	0.20 REF		
b	0.25	0.30	0.35
D	3.90	4.00	4.10
D2	2.00	---	2.25
E	3.90	4.00	4.10
E2	2.00	---	2.25
e	0.65 BSC		
L	0.45	---	0.65

Notes:

- (1) All dimensions are in millimeters.
- (2) Complies with JEDEC MO-220.

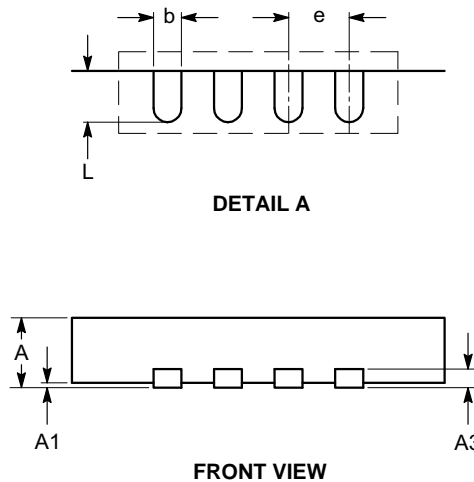

DOCUMENT NUMBER:	98AON34374E	Electronic versions are uncontrolled except when accessed directly from the Document Repository. Printed versions are uncontrolled except when stamped "CONTROLLED COPY" in red.
DESCRIPTION:	TQFN16, 4X4	PAGE 1 OF 1

onsemi and ONSEMI are trademarks of Semiconductor Components Industries, LLC dba onsemi or its subsidiaries in the United States and/or other countries. onsemi reserves the right to make changes without further notice to any products herein. onsemi makes no warranty, representation or guarantee regarding the suitability of its products for any particular purpose, nor does onsemi assume any liability arising out of the application or use of any product or circuit, and specifically disclaims any and all liability, including without limitation special, consequential or incidental damages. onsemi does not convey any license under its patent rights nor the rights of others.

onsemi, **Onsemi**, and other names, marks, and brands are registered and/or common law trademarks of Semiconductor Components Industries, LLC dba "**onsemi**" or its affiliates and/or subsidiaries in the United States and/or other countries. **onsemi** owns the rights to a number of patents, trademarks, copyrights, trade secrets, and other intellectual property. A listing of **onsemi**'s product/patent coverage may be accessed at www.onsemi.com/site/pdf/Patent-Marking.pdf. **onsemi** reserves the right to make changes at any time to any products or information herein, without notice. The information herein is provided "as-is" and **onsemi** makes no warranty, representation or guarantee regarding the accuracy of the information, product features, availability, functionality, or suitability of its products for any particular purpose, nor does **onsemi** assume any liability arising out of the application or use of any product or circuit, and specifically disclaims any and all liability, including without limitation special, consequential or incidental damages. Buyer is responsible for its products and applications using **onsemi** products, including compliance with all laws, regulations and safety requirements or standards, regardless of any support or applications information provided by **onsemi**. "Typical" parameters which may be provided in **onsemi** data sheets and/or specifications can and do vary in different applications and actual performance may vary over time. All operating parameters, including "Typicals" must be validated for each customer application by customer's technical experts. **onsemi** does not convey any license under any of its intellectual property rights nor the rights of others. **onsemi** products are not designed, intended, or authorized for use as a critical component in life support systems or any FDA Class 3 medical devices or medical devices with a same or similar classification in a foreign jurisdiction or any devices intended for implantation in the human body. Should Buyer purchase or use **onsemi** products for any such unintended or unauthorized application, Buyer shall indemnify and hold **onsemi** and its officers, employees, subsidiaries, affiliates, and distributors harmless against all claims, costs, damages, and expenses, and reasonable attorney fees arising out of, directly or indirectly, any claim of personal injury or death associated with such unintended or unauthorized use, even if such claim alleges that **onsemi** was negligent regarding the design or manufacture of the part. **onsemi** is an Equal Opportunity/Affirmative Action Employer. This literature is subject to all applicable copyright laws and is not for resale in any manner.

ADDITIONAL INFORMATION

TECHNICAL PUBLICATIONS:

Technical Library: www.onsemi.com/design/resources/technical-documentation
onsemi Website: www.onsemi.com

ONLINE SUPPORT: www.onsemi.com/support

For additional information, please contact your local Sales Representative at www.onsemi.com/support/sales