

Thank you for your interest in **onsemi** products.  
Your technical document begins on the following pages.



## Your Feedback is Important to Us!

Please take a moment to participate in our short survey.  
At **onsemi**, we are dedicated to delivering technical content that best meets your needs.

### [Help Us Improve – Take the Survey](#)

This survey is intended to collect your feedback, capture any issues you may encounter, and to provide improvements you would like to suggest.

**We look forward to your feedback.**

To learn more about **onsemi**, please visit our website at  
[www.onsemi.com](http://www.onsemi.com)

**onsemi** and **onsemi** and other names, marks, and brands are registered and/or common law trademarks of Semiconductor Components Industries, LLC dba "**onsemi**" or its affiliates and/or subsidiaries in the United States and/or other countries. **onsemi** owns the rights to a number of patents, trademarks, copyrights, trade secrets, and other intellectual property. A listing of **onsemi** product/patent coverage may be accessed at [www.onsemi.com/site/pdf/Patent-Marking.pdf](http://www.onsemi.com/site/pdf/Patent-Marking.pdf). **onsemi** reserves the right to make changes at any time to any products or information herein, without notice. The information herein is provided "as-is" and **onsemi** makes no warranty, representation or guarantee regarding the accuracy of the information, product features, availability, functionality, or suitability of its products for any particular purpose, nor does **onsemi** assume any liability arising out of the application or use of any product or circuit, and specifically disclaims any and all liability, including without limitation special, consequential or incidental damages. Buyer is responsible for its products and applications using **onsemi** products, including compliance with all laws, regulations and safety requirements or standards, regardless of any support or applications information provided by **onsemi**. "Typical" parameters which may be provided in **onsemi** data sheets and/or specifications can and do vary in different applications and actual performance may vary over time. All operating parameters, including "Typicals" must be validated for each customer application by customer's technical experts. **onsemi** does not convey any license under any of its intellectual property rights nor the rights of others. **onsemi** products are not designed, intended, or authorized for use as a critical component in life support systems or any FDA Class 3 medical devices or medical devices with a same or similar classification in a foreign jurisdiction or any devices intended for implantation in the human body. Should Buyer purchase or use **onsemi** products for any such unintended or unauthorized application, Buyer shall indemnify and hold **onsemi** and its officers, employees, subsidiaries, affiliates, and distributors harmless against all claims, costs, damages, and expenses, and reasonable attorney fees arising out of, directly or indirectly, any claim of personal injury or death associated with such unintended or unauthorized use, even if such claim alleges that **onsemi** was negligent regarding the design or manufacture of the part. **onsemi** is an Equal Opportunity/Affirmative Action Employer. This literature is subject to all applicable copyright laws and is not for resale in any manner. Other names and brands may be claimed as the property of others.

# High-Voltage Switcher for Low Power Offline SMPS

## NCP1070, NCP1071, NCP1072, NCP1075, NCP1076, NCP1077

The NCP107x products integrate a fixed frequency current mode controller with a 700 V MOSFET. Available in a PDIP-7 or SOT-223 package, the NCP107x offer a high level of integration, including soft-start, frequency-jittering, short-circuit protection, skip-cycle, a maximum peak current set point, ramp compensation, and a Dynamic Self-Supply (eliminating the need for an auxiliary winding).

Unlike other monolithic solutions, the NCP107x is quiet by nature: during nominal load operation, the part switches at one of the available frequencies (65, 100 or 130 kHz). When the output power demand diminishes, the IC automatically enters frequency foldback mode and provides excellent efficiency at light loads. When the power demand reduces further, it enters into a skip mode to reduce the standby consumption down to a no load condition.

Protection features include: a timer to detect an overload or a short-circuit event, Overvoltage Protection with auto-recovery and AC input line voltage detection.

For improved standby performance, the connection of an auxiliary winding stops the DSS operation and helps to reduce input power consumption below 50 mW at high line.

### Features

- Built-in 700 V MOSFET with  $R_{DS(on)}$  of 4.7  $\Omega$  (NCP1076/77) / 11  $\Omega$  (NCP1072/75) / 22  $\Omega$  (NCP1070/71)
- Large Creepage Distance Between High-voltage Pins
- Current-Mode Fixed Frequency Operation – 65 / 100 / 130 kHz
- Peak Current: NCP1070/72 with 250 mA, NCP1071 with 350 mA, NCP1075 with 450 mA, NCP1076 with 650 mA and NCP1077 with 800 mA
- Fixed Ramp Compensation
- Skip-Cycle Operation at Low Peak Currents Only: No Acoustic Noise!
- Dynamic Self-Supply: No Need for an Auxiliary Winding
- Internal 1 ms Soft-Start

- Auto-Recovery Output Short Circuit Protection with Timer-Based Detection
- Auto-Recovery Overvoltage Protection with Auxiliary Winding Operation
- Frequency Jittering for Better EMI Signature, Including Frequency Foldback Mode
- No Load Input Consumption < 50 mW
- Frequency Foldback to Improve Efficiency at Light Load
- Internal Temperature Shutdown
- These are Pb-Free Devices

### Typical Applications

- Auxiliary / Standby Isolated Power Supplies White Goods / Smart Meter / E-Meter

### MARKING DIAGRAMS



SOT-223  
ST SUFFIX  
CASE 318E

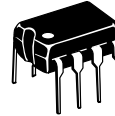
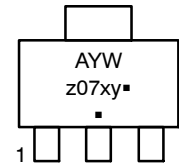

PDIP-7  
P SUFFIX  
CASE 626A

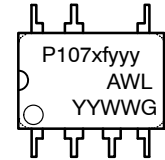

- Z = 1 for Std product; V for Automotive
- x = Current Limit (0, 1, 2, 5, 6 or 7)
- y = Oscillator Frequency  
A (65 kHz), B (100 kHz), C (130 kHz)
- yyy = 065, 100, 130
- f = OFF phase in fault mode  
P (420 ms), B (210 ms)
- A = Assembly Location
- WL = Wafer Lot
- Y, YY = Year
- W, WW = Work Week
- G or ■ = Pb-Free Package

### ORDERING INFORMATION

See detailed ordering and shipping information on page 28 of this data sheet.

# NCP1070, NCP1071, NCP1072, NCP1075, NCP1076, NCP1077

## PIN CONNECTIONS

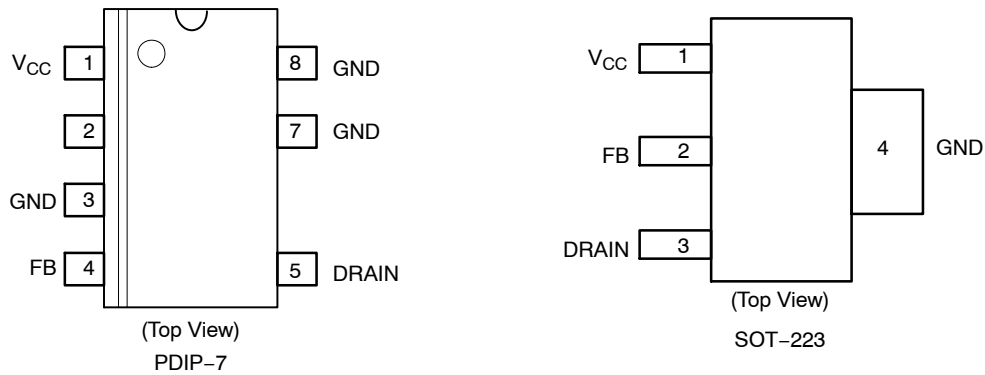

Figure 1. Pin Connections

### INDICATIVE MAXIMUM OUTPUT POWER

|                | $R_{DS(on)} - I_{PK}$ | 230 Vac | 85–265 Vac |
|----------------|-----------------------|---------|------------|
| NCP1070 / 1071 | 22 $\Omega$ – 350 mA  | 14 W    | 7.75 W     |
| NCP1072 / 1075 | 11 $\Omega$ – 450 mA  | 19 W    | 10 W       |
| NCP1076 / 1077 | 4.7 $\Omega$ – 800 mA | 25 W    | 15 W       |

NOTE: Informative values only, with  $T_{amb} = 50^{\circ}\text{C}$ ,  $F_{SW} = 65 \text{ kHz}$ , Self supply via Auxiliary winding and circuit mounted on minimum copper area as recommended.

### QUICK SELECTION TABLE

|                           | NCP1070 |     |     | NCP1071 |     |     | NCP1072 |     |      | NCP1075 |     |     | NCP1076 |     |     | NCP1077 |     |     |
|---------------------------|---------|-----|-----|---------|-----|-----|---------|-----|------|---------|-----|-----|---------|-----|-----|---------|-----|-----|
| $R_{DS(on)}$ ( $\Omega$ ) | 22      |     |     |         |     |     | 11      |     |      |         |     |     | 4.7     |     |     |         |     |     |
| $I_{peak}$ (mA)           | 250     |     |     | 350     |     |     | 250     |     |      | 450     |     |     | 650     |     |     | 800     |     |     |
| Freq (kHz)                | 65      | 100 | 130 | 65      | 100 | 130 | 65      | 100 | 130* | 65      | 100 | 130 | 65      | 100 | 130 | 65      | 100 | 130 |

\*130 kHz on demand only

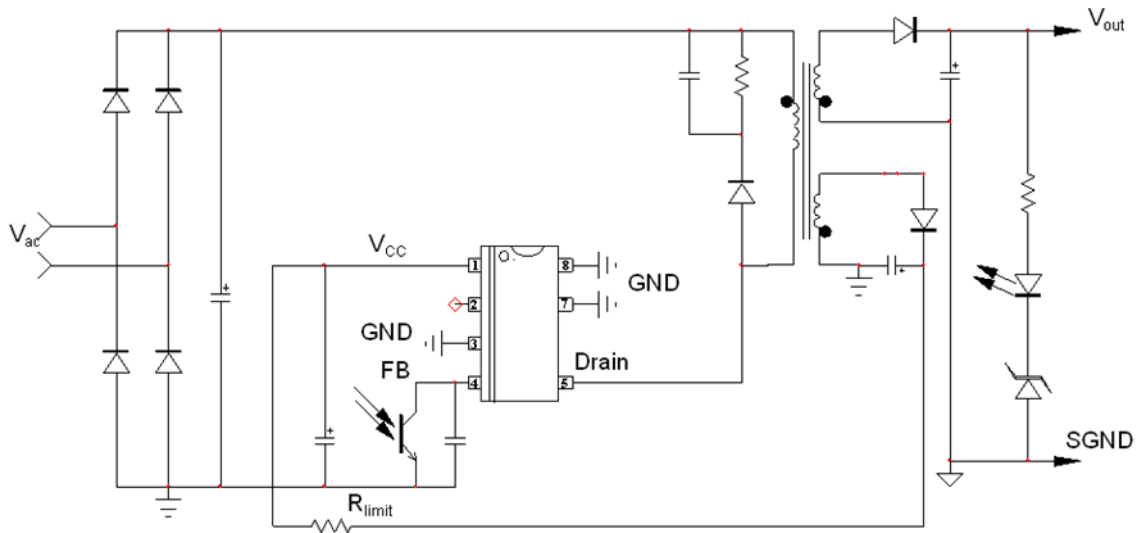

Figure 2. Typical Application Example

PIN FUNCTION DESCRIPTION

| Pin N° | Pin Name        | Function                      | Pin Description  |
|--------|-----------------|-------------------------------|--|
| 1      | V <sub>CC</sub> | Powers the internal circuitry | This pin is connected to an external capacitor. The V <sub>CC</sub> includes an active shunt which serves as an auto-recovery over voltage protection. |
| 2      | NC              |                               |  |
| 3      | GND             | The IC Ground                 |  |
| 4      | FB              | Feedback signal input         | By connecting an opto-coupler to this pin, the peak current set point is adjusted accordingly to the output power demand.                              |
| 5      | Drain           | Drain connection              | The internal drain MOSFET connection   |
| 6      |                 |                               | This un-connected pin ensures adequate creepage distance   |
| 7      | GND             | The IC Ground                 |  |
| 8      | GND             | The IC Ground                 |  |

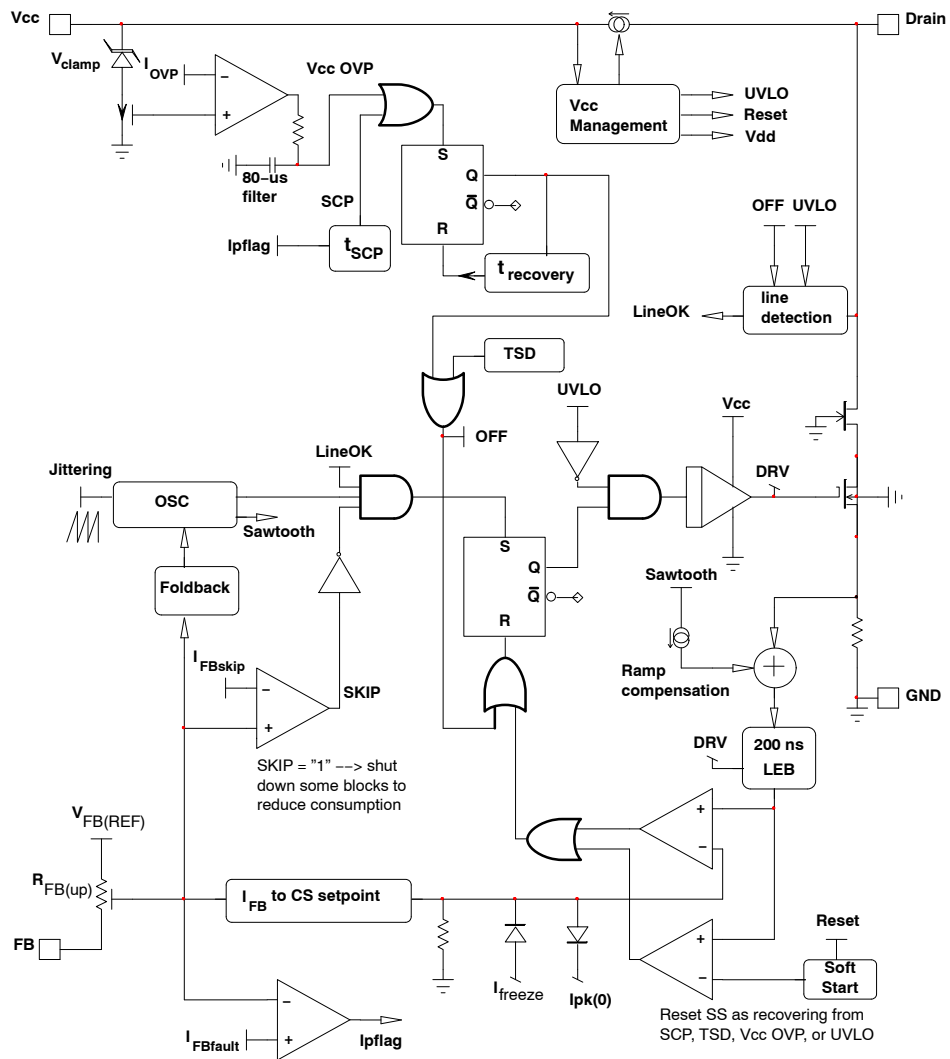

Figure 3. Simplified Internal Circuit Architecture

MAXIMUM RATINGS TABLE

| Symbol              | Rating  | Value               | Unit           |
|---------------------|---|---------------------|----------------|
| V <sub>CC</sub>     | Power Supply Voltage on all pins, except Pin 5(Drain)   | -0.3 to 10          | V              |
| BV <sub>dss</sub>   | Drain voltage   | -0.3 to 700         | V              |
| I <sub>DS(PK)</sub> | Drain current peak during transformer saturation (T <sub>J</sub> = 150°C, Note 3):<br>NCP1070/71:<br>NCP1072/75:<br>NCP1076/77: | 480<br>870<br>2200  | mA<br>mA<br>mA |
|                     | Drain current peak during transformer saturation (T <sub>J</sub> = 25°C, Note 3):<br>NCP1070/71:<br>NCP1072/75:<br>NCP1076/77:  | 850<br>1500<br>3900 | mA<br>mA<br>mA |
| I <sub>VCC</sub>    | Maximum Current into Pin 1 when Activating the 8.2 V Active Clamp   | 15                  | mA             |
| R <sub>θJ-A</sub>   | P Suffix, Case 626A   | 0.36 Sq. Inch       | °C/W           |
|                     | Junction-to-Air, 2.0 oz Printed Circuit Copper Clad   | 1.0 Sq. Inch        |                |
| R <sub>θJ-A</sub>   | ST Suffix, Plastic Package Case 318E  | 0.36 Sq. Inch       | °C/W           |
|                     | Junction-to-Air, 2.0 oz Printed Circuit Copper Clad   | 1.0 Sq. Inch        |                |
| T <sub>JMAX</sub>   | Maximum Junction Temperature  | 150                 | °C             |
|                     | Storage Temperature Range   | -60 to +150         | °C             |
|                     | ESD Capability, Human Body Model (All pins except HV)   | 2                   | kV             |
|                     | ESD Capability, Machine Model   | 200                 | V              |
|                     | ESD Capability, Charged Device Model  | 1                   | kV             |

Stresses exceeding those listed in the Maximum Ratings table may damage the device. If any of these limits are exceeded, device functionality should not be assumed, damage may occur and reliability may be affected.

1. This device series contains ESD protection and exceeds the following tests:

- Human Body Model 2000 V per JEDEC JESD22-A114-F
- Machine Model Method 200 V per JEDEC JESD22-A115-A
- Charged Device Model 1000 V per JEDEC JESD22-C101E

2. This device contains latch-up protection and exceeds 100 mA per JEDEC Standard JESD78

3. Maximum drain current I<sub>DS(PK)</sub> is obtained when the transformer saturates. It should not be mixed with short pulses that can be seen at turn on. Figure 4 below provides spike limits the device can tolerate.

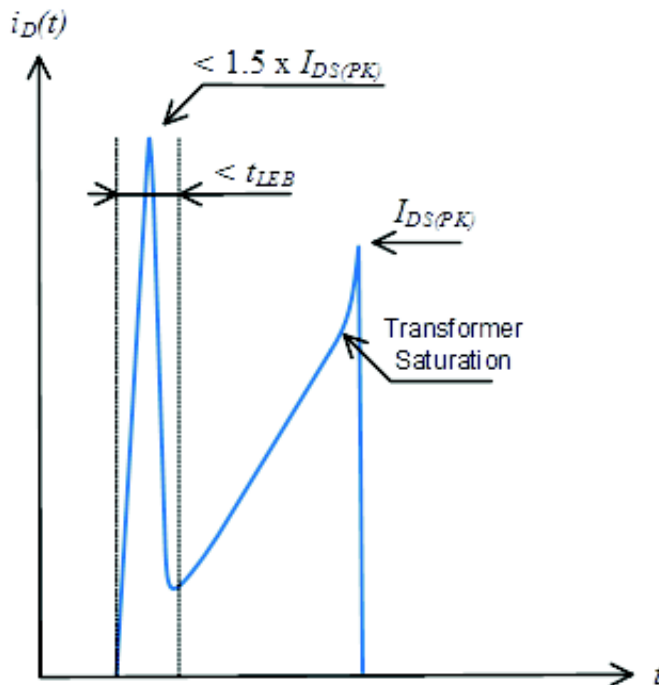

Figure 4. Spike Limits

# NCP1070, NCP1071, NCP1072, NCP1075, NCP1076, NCP1077

## ELECTRICAL CHARACTERISTICS

(For all NCP107X products except NCP1072P100BG: For typical values  $T_J = 25^\circ\text{C}$ , for min/max values  $T_J = -40^\circ\text{C}$  to  $+125^\circ\text{C}$ ,  $V_{CC} = 8\text{ V}$  unless otherwise noted)

(For NCP1072P100BG: For typical values  $T_J = 25^\circ\text{C}$ , for min/max values  $T_J = -55^\circ\text{C}$  (Note 7) to  $+125^\circ\text{C}$ ,  $V_{CC} = 8\text{ V}$  unless otherwise noted)

| Symbol | Rating | Pin | Min | Typ | Max | Unit |
|--------|--------|-----|-----|-----|-----|------|
|--------|--------|-----|-----|-----|-----|------|

### SUPPLY SECTION AND $V_{CC}$ MANAGEMENT

|                 |   |             |                   |                   |                   |               |
|-----------------|---|-------------|-------------------|-------------------|-------------------|---------------|
| $V_{CC(on)}$    | $V_{CC}$ increasing level at which the switcher starts operation<br>NCP1070/71/72/75<br>NCP1076/77                | 1<br>1      | 7.8<br>7.7        | 8.2<br>8.1        | 8.6<br>8.5        | V             |
| $V_{CC(min)}$   | $V_{CC}$ decreasing level at which the HV current source restarts   | 1           | 6.5               | 6.8               | 7.2               | V             |
| $V_{CC(off)}$   | $V_{CC}$ decreasing level at which the switcher stops operation (UVLO)  | 1           | 6.1               | 6.3               | 6.6               | V             |
| $V_{CC(reset)}$ | $V_{CC}$ voltage at which the internal latch is reset (guaranteed by design)                                      | 1           |                   | 4                 |                   | V             |
| $V_{CC(clamp)}$ | Offset voltage above $V_{CC(on)}$ at which the internal clamp activates<br>NCP1070/71<br>NCP1072/75<br>NCP1076/77 | 1<br>1<br>1 | 110<br>130<br>130 | 170<br>190<br>190 | 300<br>300<br>300 | mV            |
| $I_{CC1}$       | Internal IC consumption, Mosfet switching<br>NCP1070/71/72/75<br>NCP1076/77                                       | 1<br>1      | –<br>–            | 0.7<br>1.0        | 1.0<br>1.3        | mA            |
| $I_{CCskip}$    | Internal IC consumption, FB is 0 V (No switching on MOSFET)   | 1           |                   | 360               |                   | $\mu\text{A}$ |

### POWER SWITCH CIRCUIT

|                       |  |        |                       |                                    |                                      |               |
|-----------------------|--|--------|-----------------------|------------------------------------|--------------------------------------|---------------|
| $R_{DS(on)}$          | Power Switch Circuit on-state resistance ( $I_d = 50\text{ mA}$ )<br>NCP1070/71<br>$T_J = 25^\circ\text{C}$<br>$T_J = 125^\circ\text{C}$<br>NCP1072/75<br>$T_J = 25^\circ\text{C}$<br>$T_J = 125^\circ\text{C}$<br>NCP1076/77<br>$T_J = 25^\circ\text{C}$<br>$T_J = 125^\circ\text{C}$ | 5      | –<br>–<br>–<br>–<br>– | 22<br>38<br>11<br>19<br>4.7<br>8.7 | 32<br>55<br>16<br>24<br>6.9<br>10.75 | $\Omega$      |
| $BV_{DSS}$            | Power Switch Circuit & Startup breakdown voltage<br>( $I_{D(off)} = 120\text{ }\mu\text{A}$ , $T_J = 25^\circ\text{C}$ )   | 5      | 700                   |                                    |                                      | V             |
| $I_{DSS(off)}$        | Power Switch & Startup breakdown voltage off-state leakage current<br>$T_J = 125^\circ\text{C}$ ( $V_{ds} = 700\text{ V}$ )  | 5      |                       | 85                                 |                                      | $\mu\text{A}$ |
| $t_{on}$<br>$t_{off}$ | Switching characteristics ( $R_L = 50\text{ }\Omega$ , $V_{DS}$ set for $I_{drain} = 0.7 \times I_{lim}$ )<br>Turn-on time (90% – 10%)<br>Turn-off time (10% – 90%)  | 5<br>5 |                       | 20<br>10                           |                                      | ns            |

### INTERNAL START-UP CURRENT SOURCE

|              |   |        |          |          |            |    |
|--------------|---|--------|----------|----------|------------|----|
| $I_{start1}$ | High-voltage current source, $V = V_{CC(on)} - 200\text{ mV}$<br>NCP1070/71/76/77<br>NCP1072/75 | 5<br>5 | 5.2<br>5 | 9.2<br>9 | 12.2<br>12 | mA |
| $I_{start2}$ | High-voltage current source, $V_{CC} = 0\text{ V}$  | 5      |          | 0.5      |            | mA |
| $V_{CCTH}$   | $V_{CC}$ Transient level for $I_{start1}$ to $I_{start2}$ toggling point                        | 1      | –        | 2.2      | –          | V  |

### CURRENT COMPARATOR

|          |  |  |                            |  |                            |    |
|----------|--|--|----------------------------|--|----------------------------|----|
| $I_{PK}$ | Maximum internal current setpoint at 50% duty cycle<br>FB pin open, $T_J = 25^\circ\text{C}$<br>NCP1070<br>NCP1071<br>NCP1072<br>NCP1075<br>NCP1076<br>NCP1077 |  | –<br>–<br>–<br>–<br>–<br>– | 250<br>350<br>250<br>450<br>650<br>800 | –<br>–<br>–<br>–<br>–<br>– | mA |
|----------|--|--|----------------------------|--|----------------------------|----|

Product parametric performance is indicated in the Electrical Characteristics for the listed test conditions, unless otherwise noted. Product performance may not be indicated by the Electrical Characteristics if operated under different conditions.

4. The final switch current is:  $I_{PK(0)} / (V_{in}/L_P + S_a) \times V_{in}/L_P + V_{in}/L_P \times t_{prop}$ , with  $S_a$  the built-in slope compensation,  $V_{in}$  the input voltage,  $L_P$  the primary inductor in a flyback, and  $t_{prop}$  the propagation delay.

5. NCP1072 130 kHz on demand only.

6. Oscillator frequency is measured with disabled jittering.

7. For coldest temperature, QA sampling at  $-40^\circ\text{C}$  in production and  $-55^\circ\text{C}$  specification is Guaranteed by Characterization.

# NCP1070, NCP1071, NCP1072, NCP1075, NCP1076, NCP1077

## ELECTRICAL CHARACTERISTICS

(For all NCP107X products except NCP1072P100BG: For typical values  $T_J = 25^\circ\text{C}$ , for min/max values  $T_J = -40^\circ\text{C}$  to  $+125^\circ\text{C}$ ,  $V_{CC} = 8\text{ V}$  unless otherwise noted)

(For NCP1072P100BG: For typical values  $T_J = 25^\circ\text{C}$ , for min/max values  $T_J = -55^\circ\text{C}$  (Note 7) to  $+125^\circ\text{C}$ ,  $V_{CC} = 8\text{ V}$  unless otherwise noted)

| Symbol                    | Rating   | Pin | Min                                    | Typ                                    | Max                                     | Unit |
|---------------------------|--|-----|--|--|---|------|
| <b>CURRENT COMPARATOR</b> |  |     |  |  |   |      |
| $I_{PK(0)}$               | Maximum internal current setpoint at beginning of switching cycle<br>FB pin open, $T_J = 25^\circ\text{C}$<br>NCP1070<br>NCP1071<br>NCP1072<br>NCP1075<br>NCP1076<br>NCP1077       |     | 273<br>382<br>254<br>467<br>689<br>846 | 304<br>425<br>282<br>508<br>765<br>940 | 334<br>467<br>310<br>549<br>841<br>1034 | mA   |
| $I_{PKSW}$                | Final switch current with a primary slope of $200\text{ mA}/\mu\text{s}$ ,<br>$F_{SW} = 65\text{ kHz}$ (Note 4)<br>NCP1070<br>NCP1071<br>NCP1072<br>NCP1075<br>NCP1076<br>NCP1077  |     | –<br>–<br>–<br>–<br>–<br>–             | 314<br>427<br>296<br>510<br>732<br>881 | –<br>–<br>–<br>–<br>–<br>–              | mA   |
| $I_{PKSW}$                | Final switch current with a primary slope of $200\text{ mA}/\mu\text{s}$ ,<br>$F_{SW} = 100\text{ kHz}$ (Note 4)<br>NCP1070<br>NCP1071<br>NCP1072<br>NCP1075<br>NCP1076<br>NCP1077 |     | –<br>–<br>–<br>–<br>–<br>–             | 309<br>415<br>293<br>500<br>706<br>845 | –<br>–<br>–<br>–<br>–<br>–              | mA   |
| $I_{PKSW}$                | Final switch current with a primary slope of $200\text{ mA}/\mu\text{s}$ ,<br>$F_{SW} = 130\text{ kHz}$<br>NCP1070<br>NCP1071<br>NCP1072 (Note 5)<br>NCP1075<br>NCP1076<br>NCP1077 |     | –<br>–<br>–<br>–<br>–<br>–             | 303<br>407<br>291<br>493<br>684<br>814 | –<br>–<br>–<br>–<br>–<br>–              | mA   |
| $T_{SS}$                  | Soft-start duration (guaranteed by design)   | –   | –                                      | 1                                      | –                                       | ms   |
| $T_{LEB}$                 | Leading Edge Blanking Duration   | –   | –                                      | 200                                    | –                                       | ns   |
| $T_{prop}$                | Propagation delay from current detection to drain OFF state  | –   | –                                      | 100                                    | –                                       | ns   |

## INTERNAL OSCILLATOR

|              |   |        |          |          |          |     |
|--------------|---|--------|----------|----------|----------|-----|
| $f_{OSC}$    | Oscillation frequency, 65 kHz version, $T_J = 25^\circ\text{C}$ (Note 6)                      | –      | 59       | 65       | 71       | kHz |
| $f_{OSC}$    | Oscillation frequency, 100 kHz version, $T_J = 25^\circ\text{C}$ (Note 6)                     | –      | 90       | 100      | 110      | kHz |
| $f_{OSC}$    | Oscillation frequency, 130 kHz version, $T_J = 25^\circ\text{C}$ (Note 5 et 6)                | –      | 117      | 130      | 143      | kHz |
| $f_{jitter}$ | Frequency jittering in percentage of $f_{OSC}$  | –      | –        | $\pm 6$  | –        | %   |
| $f_{swing}$  | Jittering swing frequency   | –      | –        | 300      | –        | Hz  |
| $D_{max}$    | Maximum duty-cycle<br>NCP1070/71/72/75 except NCP1072P100BG<br>NCP1076/77/72B & NCP1072P100BG | –<br>– | 62<br>65 | 68<br>69 | 72<br>73 | %   |

## FEEDBACK SECTION

|                |   |   |   |     |   |               |
|----------------|---|---|---|-----|---|---------------|
| $I_{FBfault}$  | FB current for which Fault is detected                                  | 4 |   | –35 |   | $\mu\text{A}$ |
| $I_{FB100\%}$  | FB current for which internal current set-point is 100% ( $I_{PK(0)}$ ) | 4 |   | –44 |   | $\mu\text{A}$ |
| $I_{FBFreeze}$ | FB current for which internal current set-point is $I_{Freeze}$         | 4 | – | –90 | – | $\mu\text{A}$ |

Product parametric performance is indicated in the Electrical Characteristics for the listed test conditions, unless otherwise noted. Product performance may not be indicated by the Electrical Characteristics if operated under different conditions.

- The final switch current is:  $I_{PK(0)} / (V_{in}/L_P + S_a) \times V_{in}/L_P + V_{in}/L_P \times t_{prop}$ , with  $S_a$  the built-in slope compensation,  $V_{in}$  the input voltage,  $L_P$  the primary inductor in a flyback, and  $t_{prop}$  the propagation delay.
- NCP1072 130 kHz on demand only.
- Oscillator frequency is measured with disabled jittering.
- For coldest temperature, QA sampling at  $-40^\circ\text{C}$  in production and  $-55^\circ\text{C}$  specification is Guaranteed by Characterization.

# NCP1070, NCP1071, NCP1072, NCP1075, NCP1076, NCP1077

## ELECTRICAL CHARACTERISTICS

(For all NCP107X products except NCP1072P100BG: For typical values  $T_J = 25^\circ\text{C}$ , for min/max values  $T_J = -40^\circ\text{C}$  to  $+125^\circ\text{C}$ ,  $V_{CC} = 8\text{ V}$  unless otherwise noted)

(For NCP1072P100BG: For typical values  $T_J = 25^\circ\text{C}$ , for min/max values  $T_J = -55^\circ\text{C}$  (Note 7) to  $+125^\circ\text{C}$ ,  $V_{CC} = 8\text{ V}$  unless otherwise noted)

| Symbol | Rating | Pin | Min | Typ | Max | Unit |
|--------|--------|-----|-----|-----|-----|------|
|--------|--------|-----|-----|-----|-----|------|

### FEEDBACK SECTION

|               |  |   |  |      |  |            |
|---------------|--|---|--|------|--|------------|
| $V_{FB(REF)}$ | Equivalent pull-up voltage in linear regulation range (Guaranteed by design)   | 4 |  | 3.3  |  | V          |
| $R_{FB(up)}$  | Equivalent feedback resistor in linear regulation range (Guaranteed by design) | 4 |  | 19.5 |  | k $\Omega$ |

### FREQUENCY FOLDBACK & SKIP

|                   |   |   |    |      |    |               |
|-------------------|---|---|----|------|----|---------------|
| $I_{FBfold}$      | Start of frequency foldback feedback level                    | 4 | -  | -68  | -  | $\mu\text{A}$ |
| $I_{FBfold(end)}$ | End of frequency foldback feedback level, $F_{sw} = F_{min}$  | 4 | -  | -100 | -  | $\mu\text{A}$ |
| $F_{min}$         | The frequency below which skip-cycle occurs                   | - | 21 | 25   | 29 | kHz           |
| $I_{FBskip}$      | The feedback level to enter skip mode                         | 4 | -  | -120 | -  | $\mu\text{A}$ |
| $I_{Freeze}$      | Internal minimum current setpoint ( $I_{FB} = I_{FBFreeze}$ ) |   |    |      |    | mA            |
|                   | NCP1070   | - | -  | 88   | -  |               |
|                   | NCP1071   | - | -  | 123  | -  |               |
|                   | NCP1072   | - | -  | 88   | -  |               |
|                   | NCP1075   | - | -  | 168  | -  |               |
|                   | NCP1076   | - | -  | 228  | -  |               |
|                   | NCP1077   | - | -  | 280  | -  |               |

### RAMP COMPENSATION

|              |  |   |   |      |   |                   |
|--------------|--|---|---|------|---|-------------------|
| $S_{a(65)}$  | The internal ramp compensation @ 65 kHz  |   |   |      |   | mA/ $\mu\text{s}$ |
|              | NCP1070                                  | - | - | 7    | - |                   |
|              | NCP1071                                  | - | - | 10   | - |                   |
|              | NCP1072                                  | - | - | 4.2  | - |                   |
|              | NCP1075                                  | - | - | 7.5  | - |                   |
|              | NCP1076                                  | - | - | 15   | - |                   |
|              | NCP1077                                  | - | - | 18   | - |                   |
| $S_{a(100)}$ | The internal ramp compensation @ 100 kHz |   |   |      |   | mA/ $\mu\text{s}$ |
|              | NCP1070                                  | - | - | 11   | - |                   |
|              | NCP1071                                  | - | - | 15   | - |                   |
|              | NCP1072                                  | - | - | 6.5  | - |                   |
|              | NCP1075                                  | - | - | 11.5 | - |                   |
|              | NCP1076                                  | - | - | 23   | - |                   |
|              | NCP1077                                  | - | - | 28   | - |                   |
| $S_{a(130)}$ | The internal ramp compensation @ 130 kHz |   |   |      |   |                   |
|              | NCP1070                                  | - | - | 14   | - |                   |
|              | NCP1071                                  | - | - | 20   | - |                   |
|              | NCP1072 (Note 5)                         | - | - | 8.4  | - |                   |
|              | NCP1075                                  | - | - | 15   | - |                   |
|              | NCP1076                                  | - | - | 30   | - |                   |
|              | NCP1077                                  | - | - | 36   | - |                   |

### PROTECTIONS

|                |  |   |     |     |      |               |
|----------------|--|---|-----|-----|------|---------------|
| $t_{SCP}$      | Fault validation further to error flag assertion           | - | 40  | 53  | -    | ms            |
| $t_{recovery}$ | OFF phase in fault mode                                    |   |     |     |      | ms            |
|                | NCP1070/1/2/5/6/7  | - | -   | 420 | -    |               |
|                | NCP1072P100BG  | - | -   | 210 | -    |               |
| $I_{OVP}$      | $V_{CC}$ clamp current at which the switcher stops pulsing |   |     |     |      | mA            |
|                | NCP1070/71   | 1 | 6.2 | 8.7 | 11.2 |               |
|                | NCP1072/75/76/77   |   | 6   | 8.5 | 11   |               |
| $t_{OVP}$      | The filter of $V_{CC}$ OVP comparator                      | - | -   | 80  | -    | $\mu\text{s}$ |

Product parametric performance is indicated in the Electrical Characteristics for the listed test conditions, unless otherwise noted. Product performance may not be indicated by the Electrical Characteristics if operated under different conditions.

- The final switch current is:  $I_{PK(0)} / (V_{in}/L_P + S_a) \times V_{in}/L_P + V_{in}/L_P \times t_{prop}$ , with  $S_a$  the built-in slope compensation,  $V_{in}$  the input voltage,  $L_P$  the primary inductor in a flyback, and  $t_{prop}$  the propagation delay.
- NCP1072 130 kHz on demand only.
- Oscillator frequency is measured with disabled jittering.
- For coldest temperature, QA sampling at  $-40^\circ\text{C}$  in production and  $-55^\circ\text{C}$  specification is Guaranteed by Characterization.



# NCP1070, NCP1071, NCP1072, NCP1075, NCP1076, NCP1077

## ELECTRICAL CHARACTERISTICS

(For all NCP107X products except NCP1072P100BG: For typical values  $T_J = 25^\circ\text{C}$ , for min/max values  $T_J = -40^\circ\text{C}$  to  $+125^\circ\text{C}$ ,  $V_{CC} = 8\text{ V}$  unless otherwise noted)

(For NCP1072P100BG: For typical values  $T_J = 25^\circ\text{C}$ , for min/max values  $T_J = -55^\circ\text{C}$  (Note 7) to  $+125^\circ\text{C}$ ,  $V_{CC} = 8\text{ V}$  unless otherwise noted)

| Symbol | Rating | Pin | Min | Typ | Max | Unit |
|--------|--------|-----|-----|-----|-----|------|
|--------|--------|-----|-----|-----|-----|------|

### PROTECTIONS

|              |  |   |    |    |     |   |
|--------------|--|---|----|----|-----|---|
| $V_{HV(EN)}$ | The drain pin voltage above which allows MOSFET operate, which is detected after TSD, UVLO, SCP, or $V_{CC}$ OVP mode. | 5 | 72 | 91 | 110 | V |
|--------------|--|---|----|----|-----|---|

### TEMPERATURE MANAGEMENT

|     |   |   |     |    |  |                  |
|-----|---|---|-----|----|--|------------------|
| TSD | Temperature shutdown (Guaranteed by design)   | - | 150 |    |  | $^\circ\text{C}$ |
|     | Hysteresis in shutdown (Guaranteed by design) | - |     | 50 |  | $^\circ\text{C}$ |

Product parametric performance is indicated in the Electrical Characteristics for the listed test conditions, unless otherwise noted. Product performance may not be indicated by the Electrical Characteristics if operated under different conditions.

4. The final switch current is:  $I_{PK(0)} / (V_{in}/L_P + S_a) \times V_{in}/L_P + V_{in}/L_P \times t_{prop}$ , with  $S_a$  the built-in slope compensation,  $V_{in}$  the input voltage,  $L_P$  the primary inductor in a flyback, and  $t_{prop}$  the propagation delay.
5. NCP1072 130 kHz on demand only.
6. Oscillator frequency is measured with disabled jittering.
7. For coldest temperature, QA sampling at  $-40^\circ\text{C}$  in production and  $-55^\circ\text{C}$  specification is Guaranteed by Characterization.

TYPICAL CHARACTERISTICS

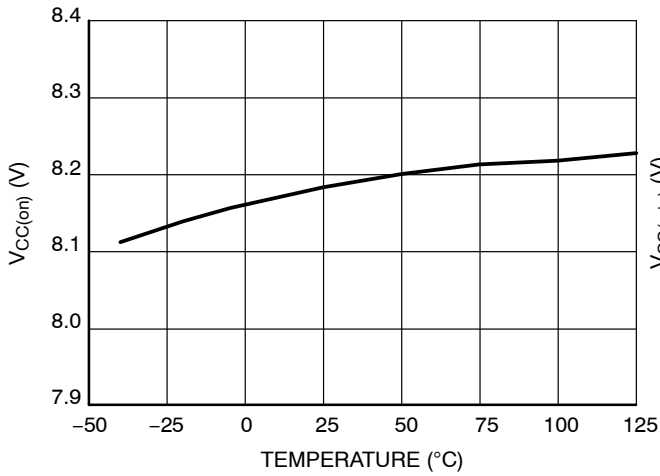

Figure 5.  $V_{CC(on)}$  vs. Temperature

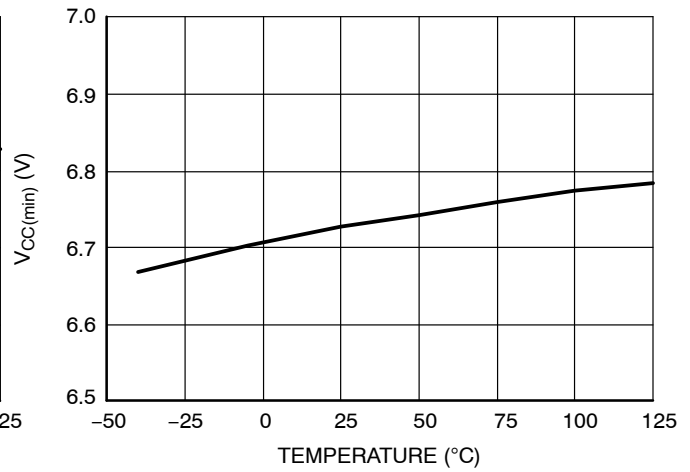

Figure 6.  $V_{CC(min)}$  vs. Temperature

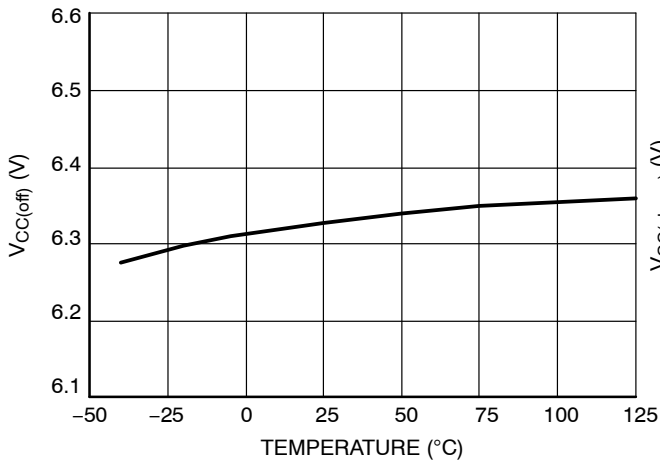

Figure 7.  $V_{CC(off)}$  vs. Temperature

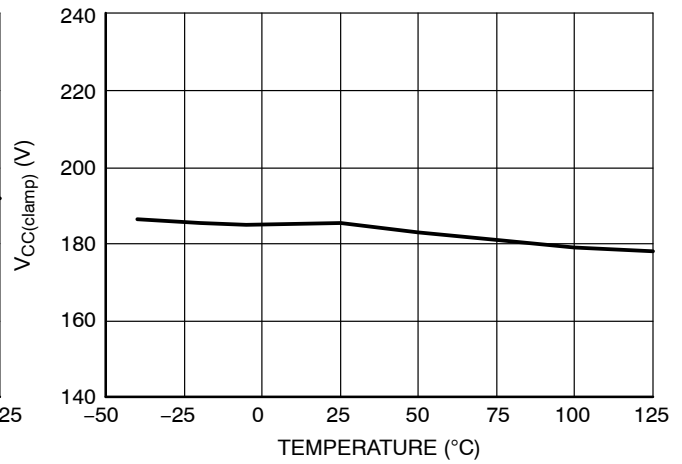

Figure 8.  $V_{CC(clamp)}$  vs. Temperature

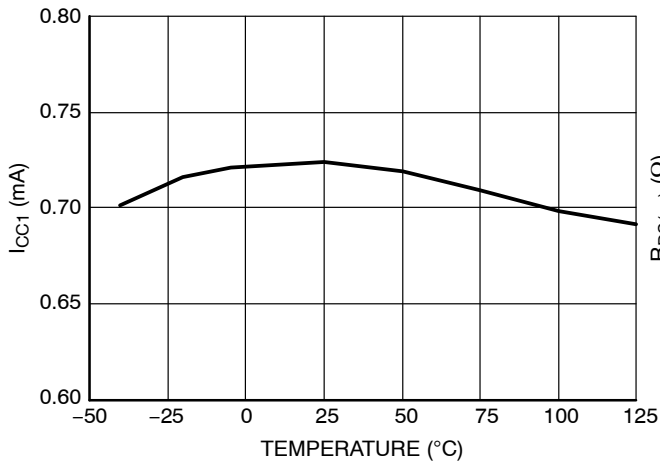

Figure 9.  $I_{CC1}$  vs. Temperature

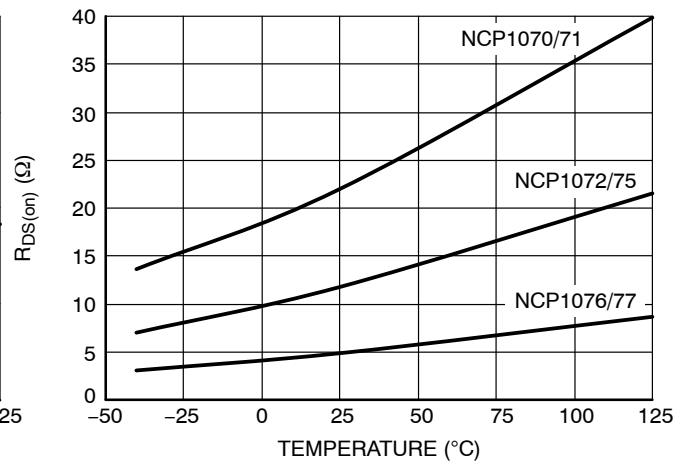

Figure 10.  $R_{DS(on)}$  vs. Temperature

TYPICAL CHARACTERISTICS

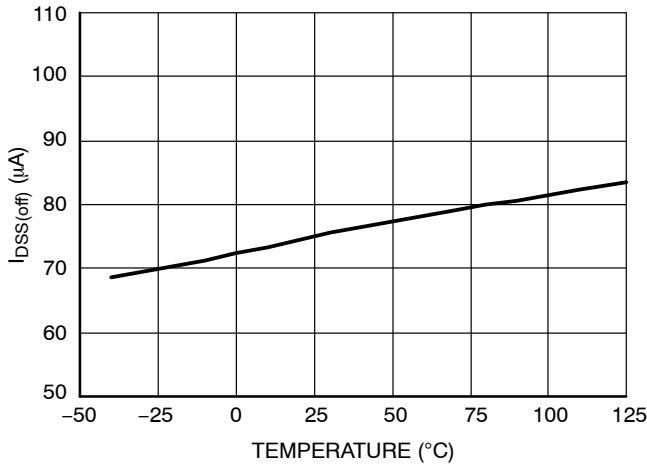

Figure 11.  $I_{DSS(off)}$  vs. Temperature

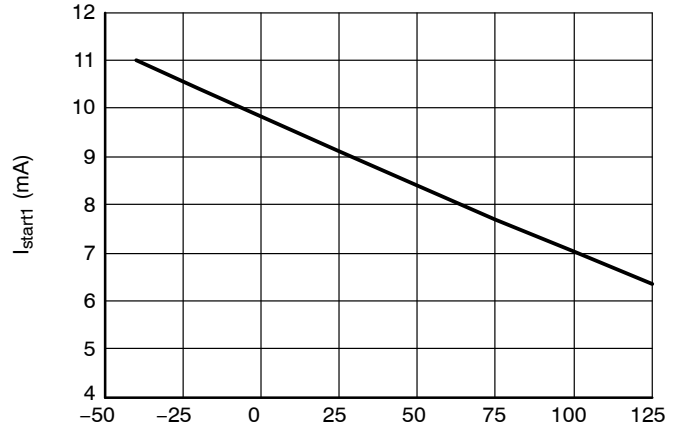

Figure 12.  $I_{start1}$  vs. Temperature

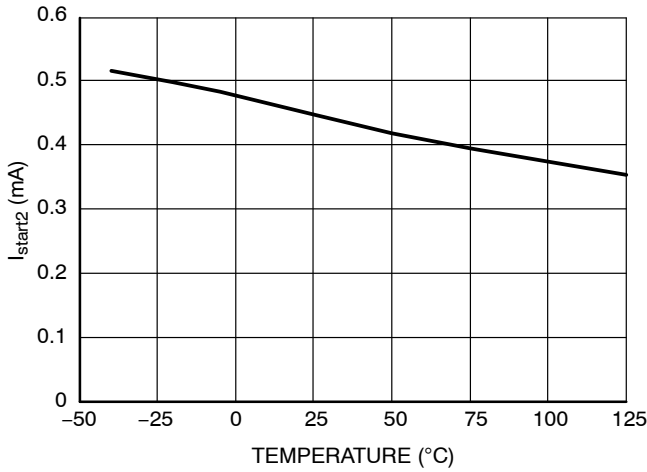

Figure 13.  $I_{start2}$  vs. Temperature

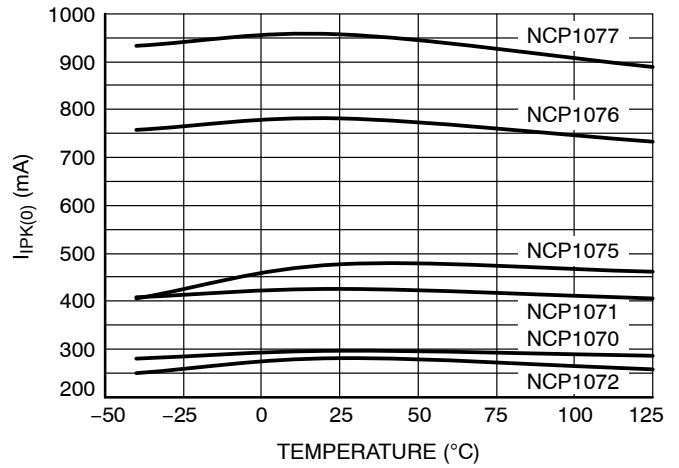

Figure 14.  $I_{IPK(0)}$  vs. Temperature

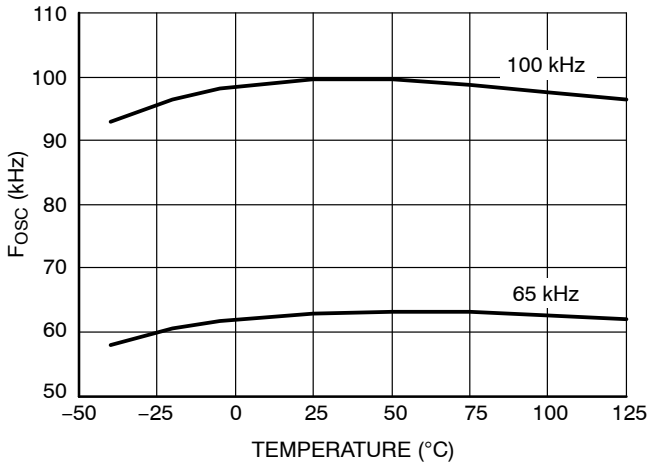

Figure 15.  $F_{osc}$  vs. Temperature

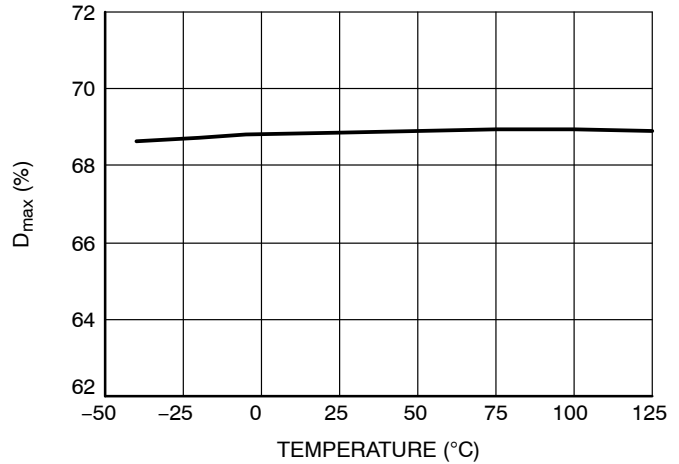

Figure 16.  $D_{(max)}$  vs. Temperature

TYPICAL CHARACTERISTICS

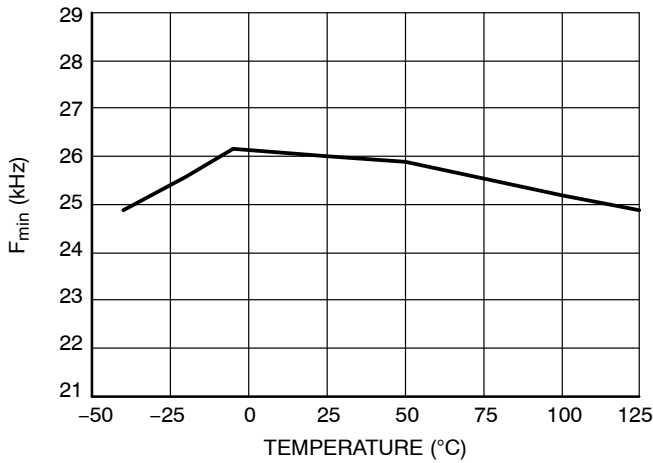

Figure 17.  $F_{min}$  vs. Temperature

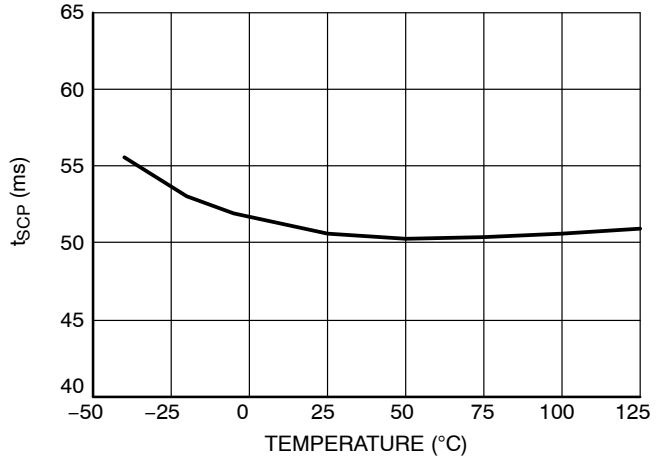

Figure 18.  $t_{SCP}$  vs. Temperature

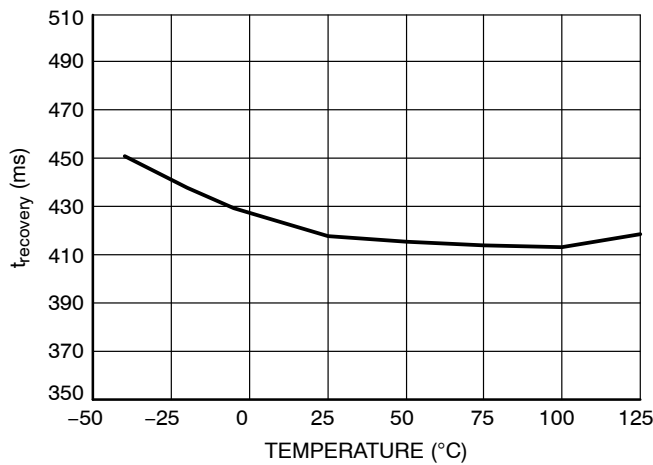

Figure 19.  $t_{recovery}$  vs. Temperature

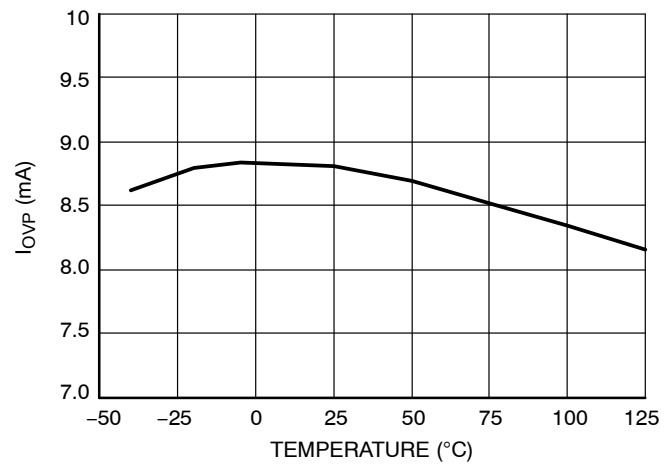

Figure 20.  $I_{OVP}$  vs. Temperature

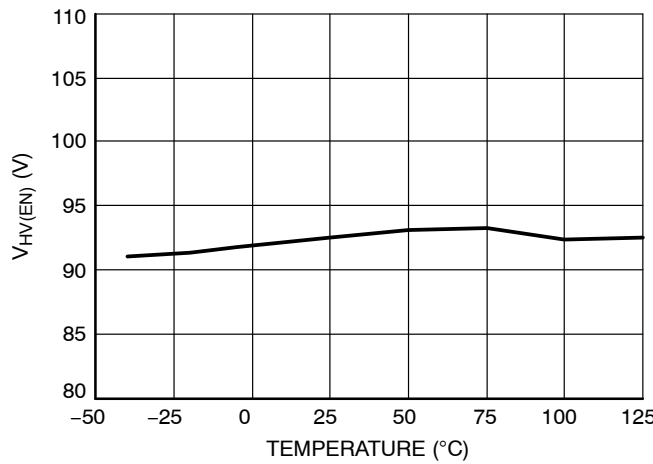

Figure 21.  $V_{HV(EN)}$  vs. Temperature

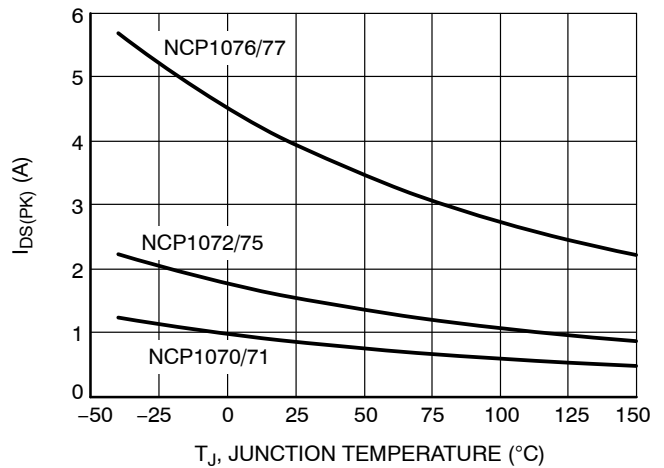

Figure 22. Drain Current Peak during Transformer Saturation vs. Junction Temperature

TYPICAL CHARACTERISTICS

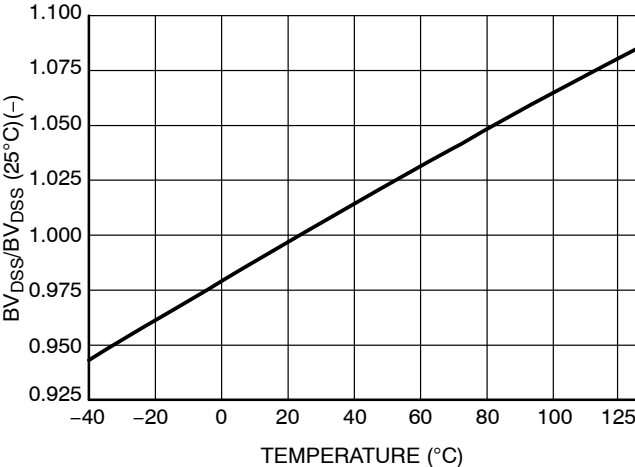

Figure 23. Breakdown Voltage vs. Temperature

## APPLICATION INFORMATION

### Introduction

The NCP107x offers a complete current-mode control solution. The component integrates everything needed to build a rugged and low-cost Switch-Mode Power Supply (SMPS) featuring low standby power. The Quick Selection Table on page 2 details the differences between references, mainly peak current setpoints and operating frequency.

- Current-mode operation: the controller uses current-mode control architecture.
- 700 V Power MOSFET: Due to **onsemi** Very High Voltage Integrated Circuit technology, the circuit hosts a high-voltage power MOSFET featuring a  $22/11/4.7 \Omega R_{DS(on)} - T_J = 25^\circ\text{C}$ . This value lets the designer build a power supply up to respectively 7.75 W, 10 W and 15 W operated on universal mains. An internal current source delivers the startup current, necessary to crank the power supply.
- Dynamic Self-Supply: Due to the internal high voltage current source, this device could be used in the application without the auxiliary winding to provide supply voltage.
- Short circuit protection: by permanently monitoring the feedback line activity, the IC is able to detect the presence of a short-circuit, immediately reducing the output power for a total system protection. A  $t_{SCP}$  timer is started as soon as the feedback current is below threshold,  $I_{FB(fault)}$ , which indicates the maximum peak current. If at the end of this timer the fault is still present, then the device enters a safe, auto-recovery burst mode, affected by a fixed timer recurrence,  $t_{recovery}$ . Once the short has disappeared, the controller resumes and goes back to normal operation.
- Built-in  $V_{CC}$  Over Voltage Protection: when the auxiliary winding is used to bias the  $V_{CC}$  pin (no DSS), an internal active clamp connected between  $V_{CC}$  and ground limits the supply dynamics to  $V_{CC(clamp)}$ . In case the current injected in this clamp exceeds a level of 6.0 mA (minimum), the controller immediately stops switching and waits a full timer period ( $t_{recovery}$ ) before

attempting to restart. If the fault is gone, the controller resumes operation. If the fault is still there, e.g. a broken opto-coupler, the controller protects the load through a safe burst mode.

- Line detection: An internal comparator monitors the drain voltage as recovering from one of the following situations:
  - ◆ Short Circuit Protection,
  - ◆  $V_{CC}$  OVP is confirmed,
  - ◆ UVLO
  - ◆ TSD

If the drain voltage is lower than the internal threshold ( $V_{HV(EN)}$ ), the internal power switch is inhibited. This avoids operating at too low ac input. This is also called brown-in function in some fields.

- Frequency jittering: an internal low-frequency modulation signal varies the pace at which the oscillator frequency is modulated. This helps spreading out energy in conducted noise analysis. To improve the EMI signature at low power levels, the jittering remains active in frequency foldback mode.
- Soft-Start: a 1 ms soft-start ensures a smooth startup sequence, reducing output overshoots.
- Frequency foldback capability: a continuous flow of pulses is not compatible with no-load/light-load standby power requirements. To excel in this domain, the controller observes the feedback current information and when it reaches a level of  $I_{FBfold}$ , the oscillator then starts to reduce its switching frequency as the feedback current continues to increase (the power demand continues to reduce). It can go down to 25 kHz (typical) reached for a feedback level of  $I_{FBfold(end)}$  (100  $\mu\text{A}$  roughly). At this point, if the power continues to drop, the controller enters classical skip-cycle mode.
- Skip: if SMPS naturally exhibits a good efficiency at nominal load, they begin to be less efficient when the output power demand diminishes. By skipping un-needed switching cycles, the NCP107x drastically reduces the power wasted during light load conditions.



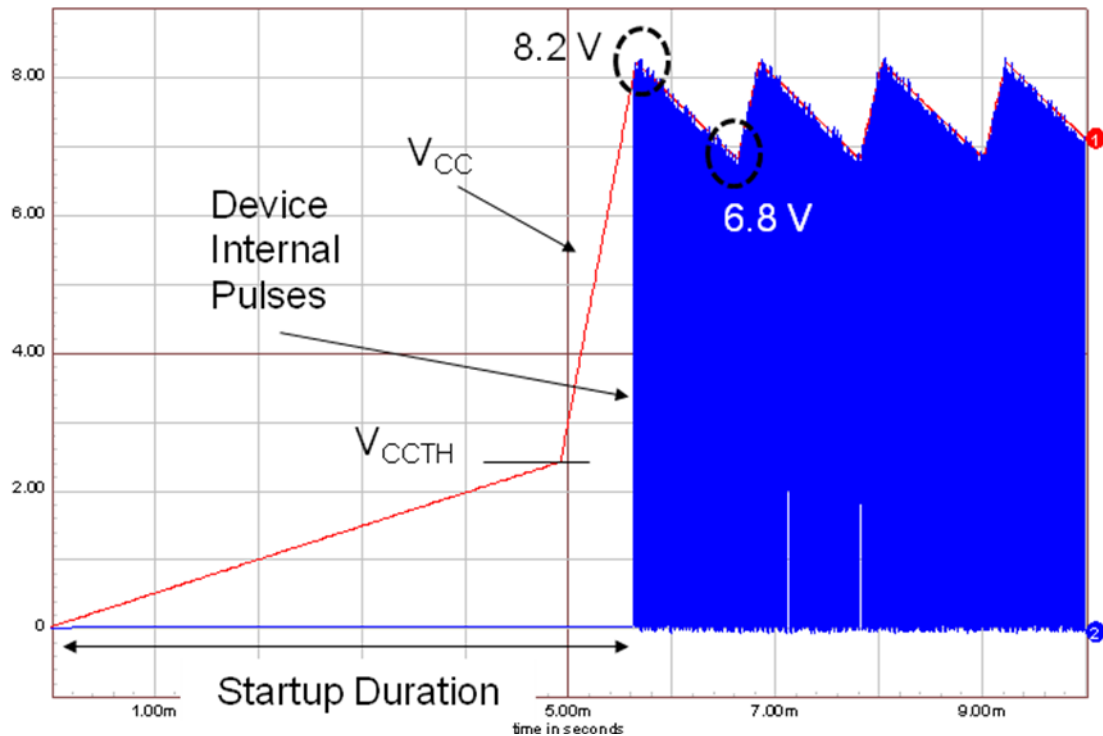

Figure 25. The Charge/Discharge Cycle Over a 1  $\mu\text{F}$   $V_{\text{CC}}$  Capacitor

As one can see, even if there is auxiliary winding to provide energy for  $V_{\text{CC}}$ , it happens that the device is still biased by DSS during start-up time or some fault mode when the voltage on auxiliary winding is not ready yet. The  $V_{\text{CC}}$  capacitor shall be dimensioned to avoid  $V_{\text{CC}}$  crosses  $V_{\text{CC(off)}}$  level, which stops operation. The  $\Delta V$  between  $V_{\text{CC(min)}}$  and  $V_{\text{CC(off)}}$  is 0.4 V. There is no current source to charge  $V_{\text{CC}}$  capacitor when driver is on, i.e. drain voltage is close to zero. Hence the  $V_{\text{CC}}$  capacitor can be calculated using

$$C_{V_{\text{CC}}} \geq \frac{I_{\text{CC1}} D_{\text{max}}}{f_{\text{OSC}} \cdot \Delta V} \quad (\text{eq. 1})$$

Take the NCP1072 65 kHz device as an example.  $C_{V_{\text{CC}}}$  should be above

$$\frac{0.8\text{m} \cdot 72\%}{59 \text{ kHz} \cdot 0.4}$$

A margin that covers the temperature drift and the voltage drop due to switching inside FET should be considered, and thus a capacitor above 0.1  $\mu\text{F}$  is appropriate.

The  $V_{\text{CC}}$  capacitor has only a supply role and its value does not impact other parameters such as fault duration or the frequency sweep period for instance. As one can see on Figure 24, an internal active zener diode, protects the switcher against lethal  $V_{\text{CC}}$  runaways. This situation can occur if the feedback loop optocoupler fails, for instance, and you would like to protect the converter against an over voltage event. In that case, the internal current increase incurred by the  $V_{\text{CC}}$  rapid growth triggers the over voltage

protection (OVP) circuit and immediately stops the output pulses for  $t_{\text{recovery}}$  duration (420 ms typically). Then a new start-up attempt takes place to check whether the fault has disappeared or not. The OVP paragraph gives more design details on this particular section.

#### Fault Condition – Short-Circuit on $V_{\text{CC}}$

In some fault situations, a short-circuit can purposely occur between  $V_{\text{CC}}$  and GND. In high line conditions ( $V_{\text{HV}} = 370 V_{\text{DC}}$ ) the current delivered by the startup device will seriously increase the junction temperature. For instance, since  $I_{\text{start1}}$  equals 5 mA (the min corresponds to the highest  $T_j$ ), the device would dissipate  $370 \times 5 \text{ m} = 1.85 \text{ W}$ . To avoid this situation, the controller includes a novel circuitry made of two startup levels,  $I_{\text{start1}}$  and  $I_{\text{start2}}$ . At power-up, as long as  $V_{\text{CC}}$  is below a 2.4 V level, the source delivers  $I_{\text{start2}}$  (around 500  $\mu\text{A}$  typical), then, when  $V_{\text{CC}}$  reaches 2.4 V, the source smoothly transitions to  $I_{\text{start1}}$  and delivers its nominal value. As a result, in case of short-circuit between  $V_{\text{CC}}$  and GND, the power dissipation will drop to  $370 \times 500\mu = 185 \text{ mW}$ . Figure 25 portrays this particular behavior.

The first startup period is calculated by the formula  $C \times V = I \times t$ , which implies a  $1\mu \times 2.4 / 500\mu = 4.8 \text{ ms}$  startup time for the first sequence. The second sequence is obtained by toggling the source to 8 mA with a delta V of  $V_{\text{CC(on)}} - V_{\text{CCTH}} = 8.2 - 2.4 = 5.8 \text{ V}$ , which finally leads to a second startup time of  $1\mu \times 5.8 / 8\text{m} = 0.725 \text{ ms}$ . The total startup time becomes  $4.8\text{m} + 0.725\text{m} = 5.525 \text{ ms}$ . Please note that this calculation is approximated by the presence of the knee in the vicinity of the transition.



**Fault Condition – Output Short–Circuit**

As soon as  $V_{CC}$  reaches  $V_{CC(on)}$ , drive pulses are internally enabled. If everything is correct, the auxiliary winding increases the voltage on the  $V_{CC}$  pin as the output voltage rises. During the start–sequence, the controller smoothly ramps up the peak drain current to maximum setting, i.e.  $I_{PK}$ , which is reached after a typical period of 1 ms. When the output voltage is not regulated, the current coming through FB pin is below  $I_{FBfault}$  level (35  $\mu$ A typically), which is not only during the startup period but also anytime an overload occurs, an internal error flag is

asserted, Ipflag, indicating that the system has reached its maximum current limit set point. The assertion of this flag triggers a fault counter  $t_{SCP}$  (53 ms typically). If at counter completion, Ipflag remains asserted, all driving pulses are stopped and the part stays off in  $t_{recovery}$  duration (about 420 ms). A new attempt to re–start occurs and will last 53 ms providing the fault is still present. If the fault still affects the output, a safe burst mode is entered, affected by a low duty–cycle operation (11%). When the fault disappears, the power supply quickly resumes operation. Figure 26 depicts this particular mode:

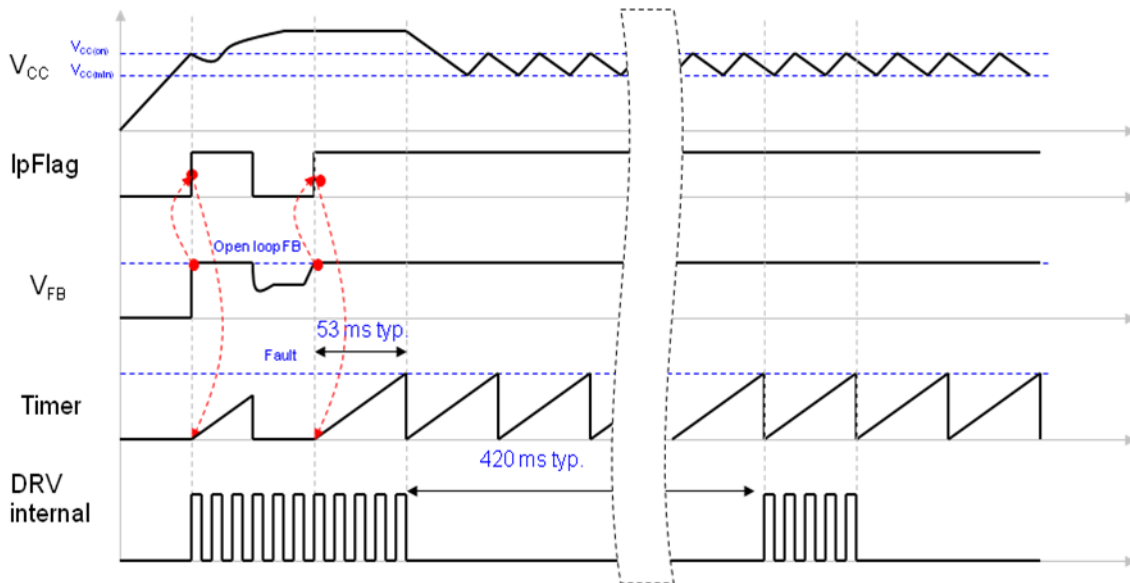

**Figure 26. In Case of Short–Circuit or Overload, the NCP107X Protects Itself and the Power Supply Via a Low Frequency Burst Mode. The  $V_{CC}$  is Maintained by the Current Source and Self–supplies the Controller.**

**Auto–Recovery Over Voltage Protection**

The particular NCP107X arrangement offers a simple way to prevent output voltage runaway when the optocoupler fails. As Figure 27 shows, an active zener diode monitors and protects the  $V_{CC}$  pin. Below its equivalent breakdown voltage, that is to say 8.4 V typical, no current flows in it. If the auxiliary  $V_{CC}$  pushes too much current inside the zener, then the controller considers an OVP situation and stops the internal drivers. When an OVP occurs, all switching pulses are permanently disabled. After  $t_{recovery}$  delay, it resumes the internal drivers. If the failure symptom still exists, e.g. feedback opto–coupler fails, the device keeps the auto–recovery OVP mode.

Figure 27 shows that the insertion of a resistor ( $R_{limit}$ ) between the auxiliary dc level and the  $V_{CC}$  pin is mandatory a) not to damage the internal 8.4 V zener diode during an overshoot for instance (absolute maximum current is 15 mA) b) to implement the fail–safe optocoupler protection (OVP) as offered by the active clamp. Please note that there cannot be bad interaction between the clamping voltage of the internal zener and  $V_{CC(on)}$  since this clamping voltage is actually built on top of  $V_{CC(on)}$  with a fixed amount of offset (200 mV typical).  $R_{limit}$  should be carefully selected to avoid

triggering the OVP as we discussed, but also to avoid disturbing the  $V_{CC}$  in low / light load conditions. The below lines detail how to evaluate the  $R_{limit}$  value...

Self–supplying controllers in extremely low standby applications often puzzles the designer. Actually, if a SMPS operated at nominal load can deliver an auxiliary voltage of an arbitrary 16 V ( $V_{nom}$ ), this voltage can drop below 10 V ( $V_{stby}$ ) when entering standby. This is because the recurrence of the switching pulses expands so much that the low frequency re–fueling rate of the  $V_{CC}$  capacitor is not enough to keep a proper auxiliary voltage. Figure 28 portrays a typical scope shot of a SMPS entering deep standby (output un–loaded). Thus, care must be taken when calculating  $R_{limit}$  1) to not trigger the  $V_{CC}$  over current latch (by injecting 6 mA into the active clamp – always use the minimum value for worse case design) in normal operation but 2) not to drop too much voltage over  $R_{limit}$  when entering standby. Otherwise, the converter will enter dynamic self supply mode (DSS mode), which increases the power dissipation. Based on these recommendations, we are able to bound  $R_{limit}$  between two equations:

## NCP1070, NCP1071, NCP1072, NCP1075, NCP1076, NCP1077

$$\frac{V_{nom} - V_{CC(clamp)}}{I_{trip}} \leq R_{limit} \leq \frac{V_{stby} - V_{CC(min)}}{I_{CCskip}} \quad (\text{eq. 2})$$

Where:

$V_{nom}$  is the auxiliary voltage at nominal load

$V_{stby}$  is the auxiliary voltage when standby is entered

$I_{trip}$  is the current corresponding to the nominal operation. It thus must be selected to avoid false tripping in overshoot conditions. Always use the minimum of the specification for a robust design, i.e.  $I_{trip} < I_{OVP}$ .

$I_{CCskip}$  is the controller consumption during skip mode.

This number decreases compared to normal operation since the part in standby does almost not switch. It is around 0.36 mA for the NCP1072 65 kHz version.

$V_{CC(min)}$  is the level above which the auxiliary voltage must be maintained to keep the controller away from the dynamic self supply mode (DSS mode), which is not a problem in itself if low standby power does not matter.

If a further improvement on standby efficiency is concerned, it is good to obtain  $V_{CC}$  around 8 V at no load condition in order not to re-activate the internal clamp circuit.

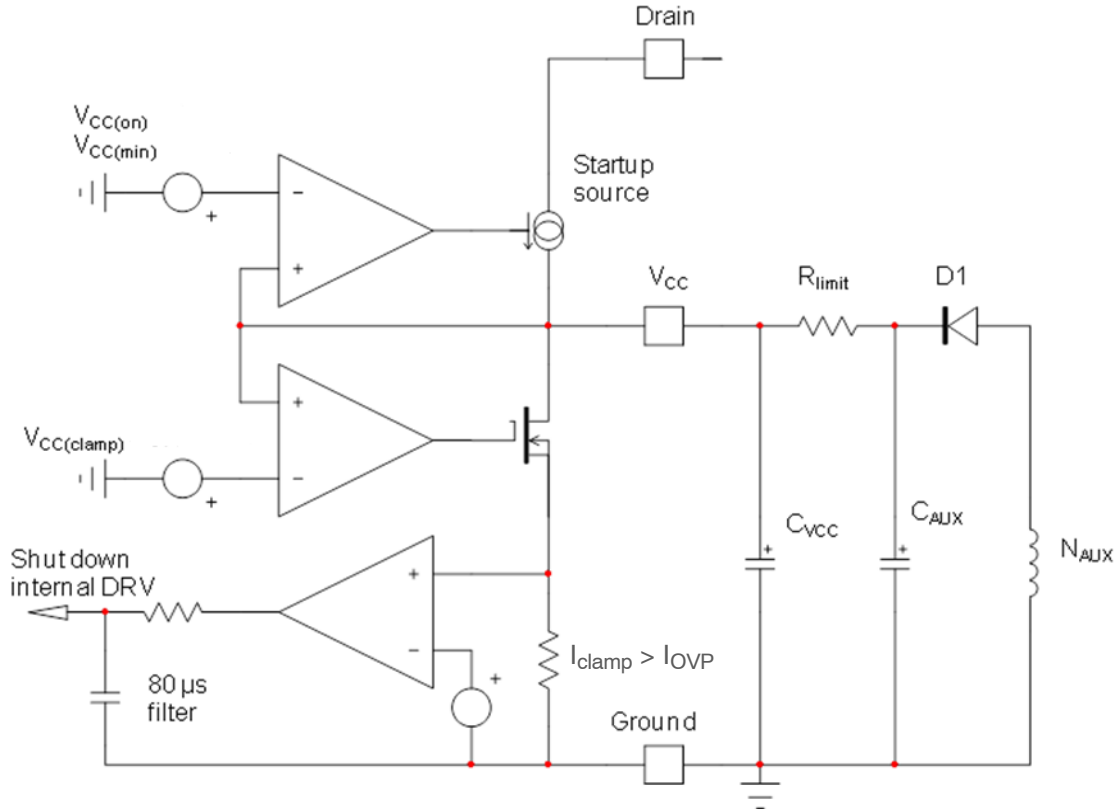

**Figure 27. A More Detailed View of the NCP107x Offers Better Insight on How to Properly Wire an Auxiliary Winding**

Since  $R_{limit}$  shall not bother the controller in standby, e.g. keep  $V_{CC}$  to above  $V_{CC(min)}$  (7.2 V maximum), we purposely select a  $V_{nom}$  well above this value. As explained before, experience shows that a 40% decrease can be seen on auxiliary windings from nominal operation down to standby mode. Let's select a nominal auxiliary winding of 13 V to offer sufficient margin regarding 7.2 V when in standby ( $R_{limit}$  also drops voltage in standby...). Plugging the values in Equation 2 gives the limits within which  $R_{limit}$  shall be selected:

$$\frac{13 - 8.4}{6m} \leq R_{limit} \leq \frac{8 - 7.2}{0.36m}$$

that is to say:  $0.77 \text{ k}\Omega < R_{limit} < 2.2 \text{ k}\Omega$ .

If we design a 65 kHz power supply delivering 12V, then the ratio between auxiliary and power must be:  $13 / 12 =$

1.08. The OVP latch will activate when the clamp current exceeds 6 mA. This will occur when  $V_{auxiliary}$  grows-up to:

1.  $8.4 + 0.77k \times (6m + 0.8m) \approx 13.6 \text{ V}$  for the first boundary ( $R_{limit} = 0.77 \text{ k}\Omega$ )
2.  $8.4 + 2.2k \times (6m + 0.8m) \approx 23.4 \text{ V}$  for the second boundary ( $R_{limit} = 2.2 \text{ k}\Omega$ )

Due to a 1.08 ratio between the auxiliary  $V_{CC}$  and the power winding, the OVP will be seen as a lower overshoot on the real output:

1.  $13.6 / 1.08 \approx 12.6 \text{ V}$
2.  $23.4 / 1.08 \approx 21.7 \text{ V}$

As one can see, tweaking the  $R_{limit}$  value will allow the selection of a given overvoltage output level. Theoretically predicting the auxiliary drop from nominal to standby is an

## NCP1070, NCP1071, NCP1072, NCP1075, NCP1076, NCP1077

almost impossible exercise since many parameters are involved, including the converter time constants. Fine tuning of  $R_{limit}$  thus requires a few iterations and experiments on a breadboard to check the auxiliary voltage

variations but also the output voltage excursion in fault. Once properly adjusted, the fail-safe protection will preclude any lethal voltage runaways in case a problem would occur in the feedback loop.

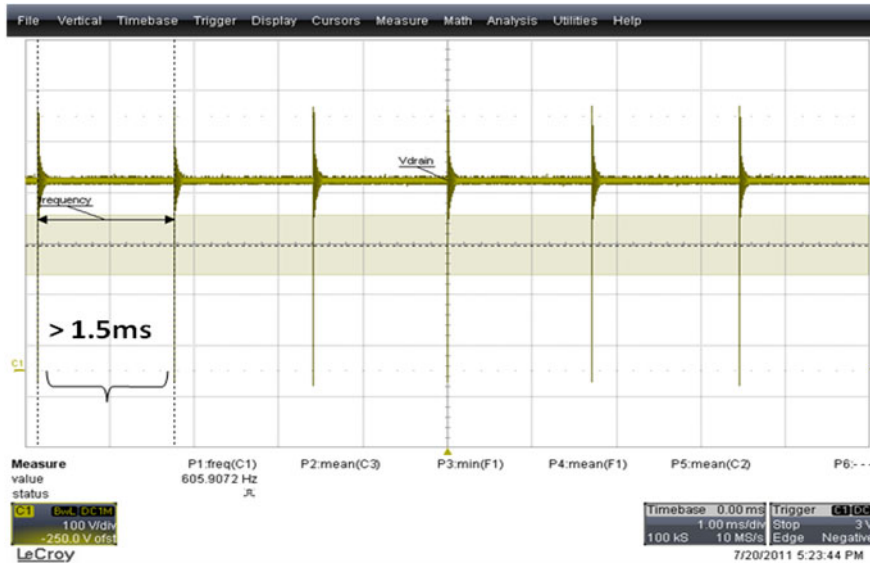

Figure 28. The Burst Frequency Becomes so Low That it is Difficult to Keep an Adequate Level on the Auxiliary  $V_{CC}$ ...

Figure 29 describes the main signal variations when the part operates in auto-recovery OVP:

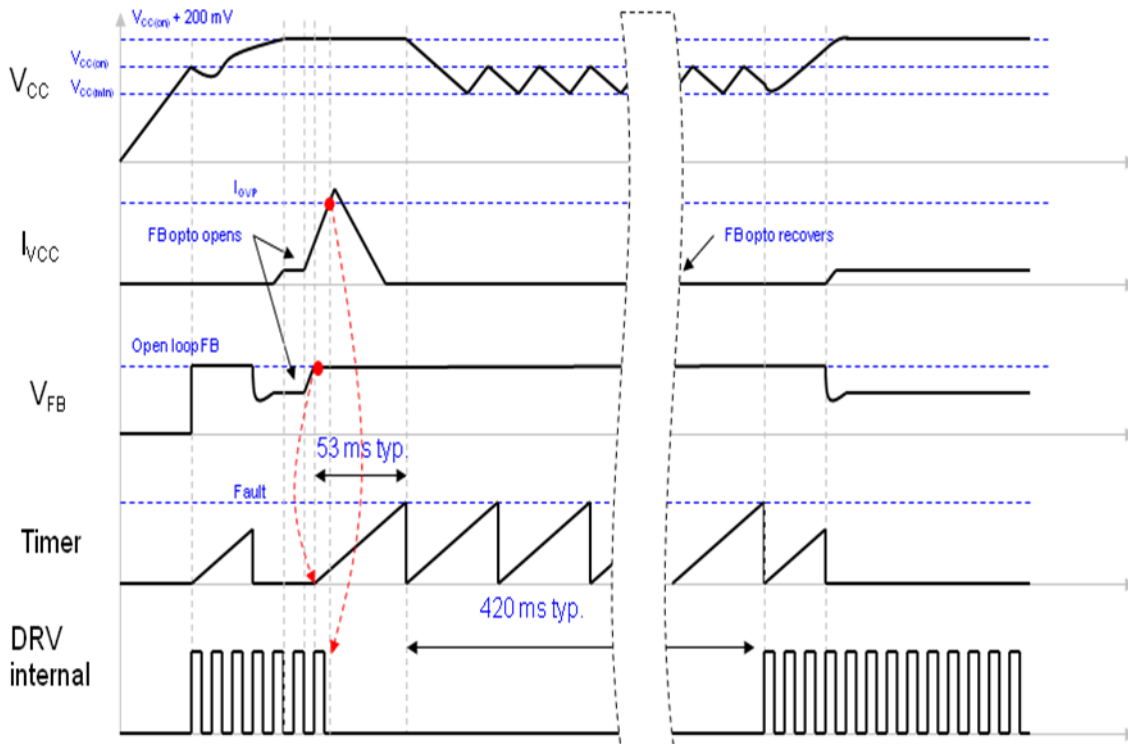

Figure 29. If the  $V_{CC}$  Current Exceeds a Certain Threshold, an Auto-Recovery Protection is Activated

**Improving the precision in auto-recovery OVP**

Given the OVP variations the internal trip current dispersion incur, it is sometimes more interesting to explore a different solution, improving the situation to the cost of a minimal amount of surrounding elements. Figure 30 shows that adding a simple zener diode on top of the limiting resistor, offers a better precision since what matters now is the internal  $V_{CC(on)}$  breakdown plus the zener voltage. A resistor in series with the zener diodes keeps the maximum current in the  $V_{CC}$  pin below the maximum rating of 15 mA just before trip the OVP.

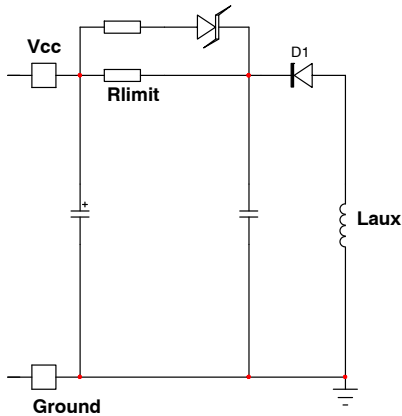

Figure 30. A Simple Zener Diode Added in Parallel

**Soft-Start**

The NCP107X features a 1 ms soft-start which reduces the power-on stress but also contributes to lower the output overshoot. Figure 31 shows a typical operating waveform. The NCP107X features a novel patented structure which offers a better soft-start ramp, almost ignoring the start-up pedestal inherent to traditional current-mode supplies:

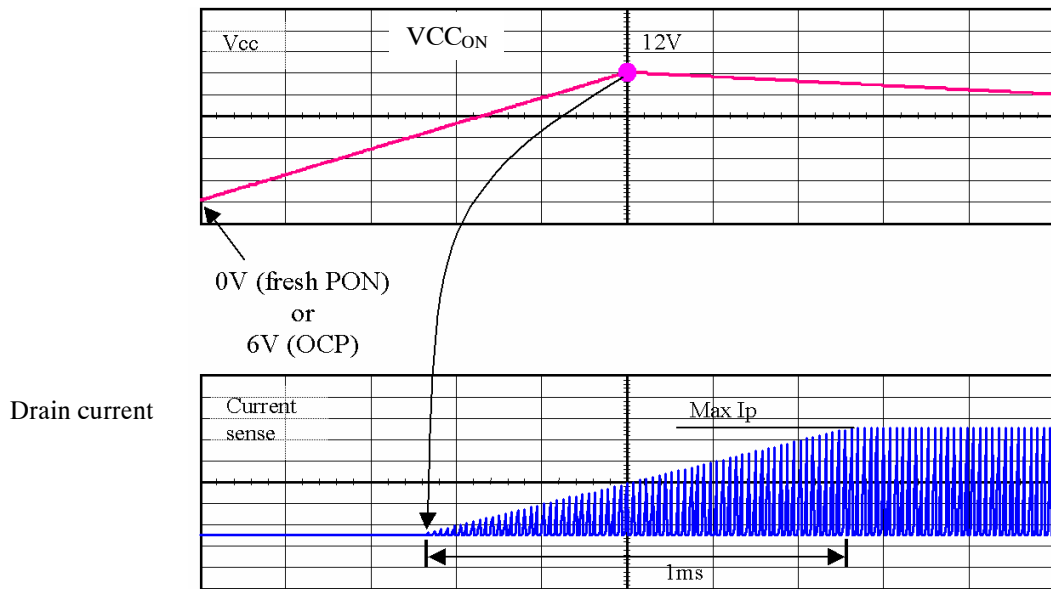

Figure 31. The 1 ms soft-start sequence

**Jittering**

Frequency jittering is a method used to soften the EMI signature by spreading the energy in the vicinity of the main switching component. The NCP107X offers a  $\pm 6\%$  deviation of the nominal switching frequency. The sweep

sawtooth is internally generated and modulates the clock up and down with a fixed frequency of 300 Hz. Figure 32 shows the relationship between the jitter ramp and the frequency deviation. It is not possible to externally disable the jitter.

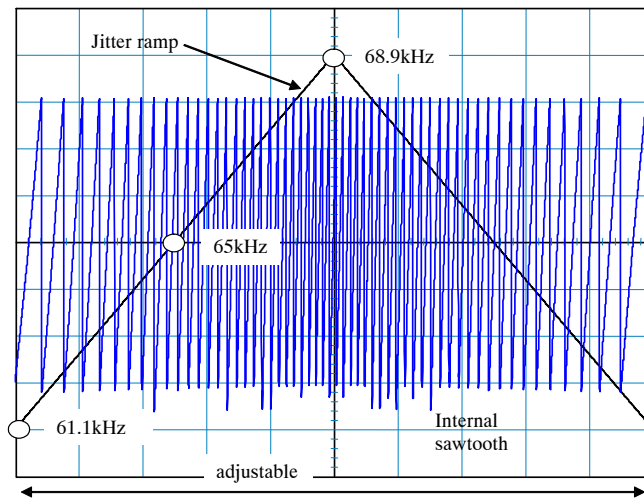

Figure 32. Modulation Effects on the Clock Signal by the Jittering Sawtooth

#### Line Detection

An internal comparator monitors the drain voltage as recovering from one of the following situations:

- Short Circuit Protection,
- $V_{CC}$  OVP is confirmed,
- UVLO
- TSD

If the drain voltage is lower than the internal threshold  $V_{HV(EN)}$  (91 Vdc typically), the internal power switch is inhibited. This avoids operating at too low ac input. This is also called brown-in function in some fields.

#### Frequency Foldback

The reduction of no-load standby power associated with the need for improving the efficiency, requires to change the traditional fixed-frequency type of operation. This device implements a switching frequency foldback when the feedback current passes above a certain level,  $I_{FBfold}$ , set around 68  $\mu A$ . At this point, the oscillator enters frequency foldback and reduces its switching frequency.

The internal peak current set-point is following the feedback current information until its level reaches the minimal freezing level point of  $I_{Freeze}$ . The only way to further reduce the transmitted power is to diminish the operating frequency down to  $F_{min}$  (25 kHz typically). This value is reached at a feedback current level of  $I_{FBfold(end)}$ . Below this point, if the output power continues to decrease, the part enters skip cycle for the best noise-free performance in no-load conditions. Figures 33 and 34 depict the adopted scheme for the part.

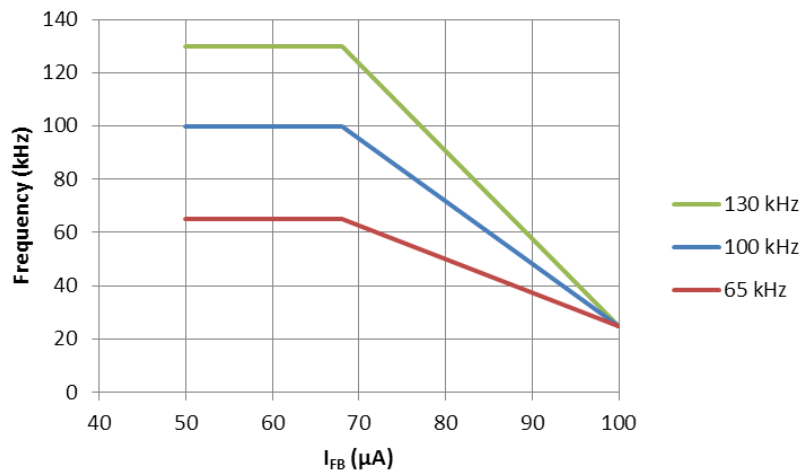

Figure 33. By Observing the Current on the Feedback Pin, the Controller Reduces its Switching Frequency for an Improved Performance at Light Load

## NCP1070, NCP1071, NCP1072, NCP1075, NCP1076, NCP1077

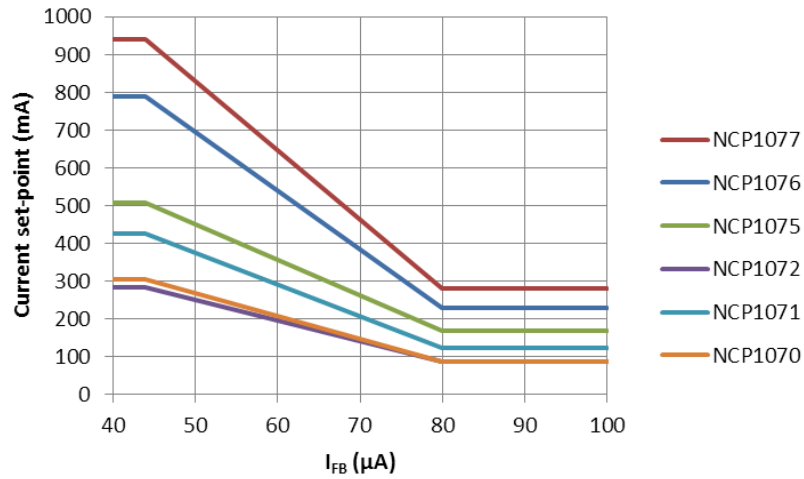

Figure 34. Ipk Set-point is Frozen at Lower Power Demand.

### Feedback and Skip

Figure 35 depicts the relationship between feedback voltage and current. The feedback pin operates linearly as the absolute value of feedback current ( $I_{FB}$ ) is above  $40 \mu A$ .

In this linear operating range, the dynamic resistance is  $19.5 k\Omega$  typically ( $R_{FB(up)}$ ) and the effective pull up voltage is  $3.3 V$  typically ( $V_{FB(REF)}$ ). When  $I_{FB}$  is below  $40 \mu A$ , the FB voltage will jump to close to  $4.5 V$ .

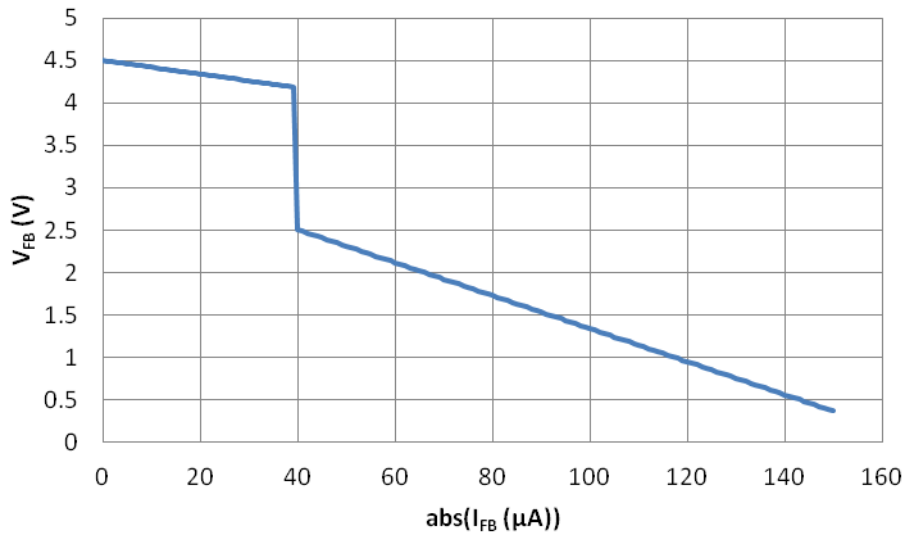

Figure 35. Feedback Voltage vs. Current

Figure 36 depicts the skip mode block diagram. When the FB current information reaches  $I_{FB(skip)}$ , the internal clock to set the flip-flop is blanked and the internal consumption of the controller is decreased. The hysteresis of internal skip

comparator is minimized to lower the ripple of the auxiliary voltage for  $V_{CC}$  pin and  $V_{OUT}$  of power supply during skip mode. It eases the design of  $V_{CC}$  over load range.

# NCP1070, NCP1071, NCP1072, NCP1075, NCP1076, NCP1077

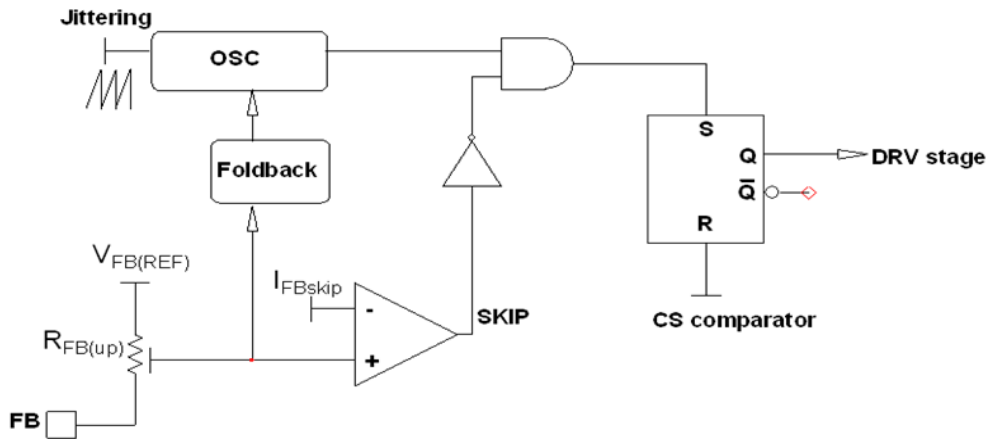

Figure 36. Skip Cycle Schematic

## Ramp Compensation and Ipk Set-point

In order to allow the NCP107X to operate in CCM with a duty cycle above 50%, a fixed slope compensation is internally applied to the current-mode control.

Here we got a table of the ramp compensation, the initial current set point, and the final current set-point of different versions of switcher.

|         | Fsw     | Sa         | Ipk(Duty = 50%) | Ipk(0) |
|---------|---------|------------|-----------------|--------|
| NCP1070 | 65 kHz  | 7 mA/μs    | 250 mA          | 304 mA |
|         | 100 kHz | 11 mA/μs   |                 |        |
|         | 130 kHz | 14 mA/μs   |                 |        |
| NCP1071 | 65 kHz  | 10 mA/μs   | 350 mA          | 425 mA |
|         | 100 kHz | 15 mA/μs   |                 |        |
|         | 130 kHz | 20 mA/μs   |                 |        |
| NCP1072 | 65 kHz  | 4.2 mA/μs  | 250 mA          | 282 mA |
|         | 100 kHz | 6.5 mA/μs  |                 |        |
|         | 130 kHz | 8.4 mA/μs  |                 |        |
| NCP1075 | 65 kHz  | 7.5 mA/μs  | 450 mA          | 508 mA |
|         | 100 kHz | 11.5 mA/μs |                 |        |
|         | 130 kHz | 15 mA/μs   |                 |        |
| NCP1076 | 65 kHz  | 15 mA/μs   | 650 mA          | 765 mA |
|         | 100 kHz | 23 mA/μs   |                 |        |
|         | 130 kHz | 30 mA/μs   |                 |        |
| NCP1077 | 65 kHz  | 18 mA/μs   | 800 mA          | 940 mA |
|         | 100 kHz | 28 mA/μs   |                 |        |
|         | 130 kHz | 36 mA/μs   |                 |        |

## NCP1070, NCP1071, NCP1072, NCP1075, NCP1076, NCP1077

The Figure 37 depicts the variation of  $I_{PK}$  set-point vs. the power switcher duty ratio, which is caused by the internal ramp compensation.

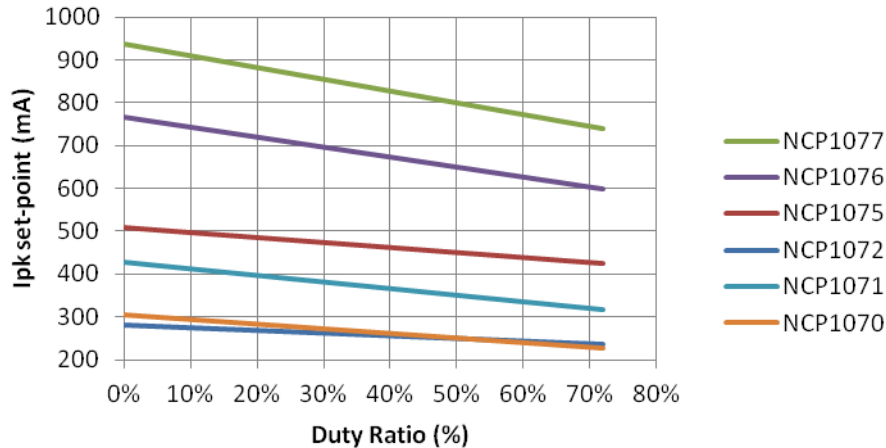

**Figure 37.  $I_{PK}$  Set-point Varies with Power Switch On Time, Which is Caused by the Ramp Compensation**

### Design Procedure

The design of an SMPS around a monolithic device does not differ from that of a standard circuit using a controller and a MOSFET. However, one needs to be aware of certain characteristics specific of monolithic devices. Let us follow the steps:

$V_{in\ min} = 90\ V_{ac}$  or  $127\ V_{dc}$  once rectified, assuming a low bulk ripple

$V_{in\ max} = 265\ V_{ac}$  or  $375\ V_{dc}$

$V_{out} = 12\ V$

$P_{out} = 10\ W$

Operating mode is CCM

$\eta = 0.8$

1. The lateral MOSFET body-diode shall never be forward biased, either during start-up (because of a large leakage inductance) or in normal operation as shown by Figure 38. This condition sets the

maximum voltage that can be reflected during  $t_{off}$ . As a result, the Flyback voltage which is reflected on the drain at the switch opening cannot be larger than the input voltage. When selecting components, you thus must adopt a turn ratio which adheres to the following equation:

$$N(V_{out} + V_f) < V_{in,min} \quad (\text{eq. 3})$$

2. In our case, since we operate from a 127 V DC rail while delivering 12 V, we can select a reflected voltage of 120 Vdc maximum. Therefore, the turn ratio  $N_p:N_s$  must be smaller than

$$\frac{V_{reflect}}{V_{out} + V_f} = \frac{120}{12 + 0.5} = 9.6$$

or  $N_p:N_s < 9.6$ . Here we choose  $N = 8$  in this case. We will see later on how it affects the calculation.

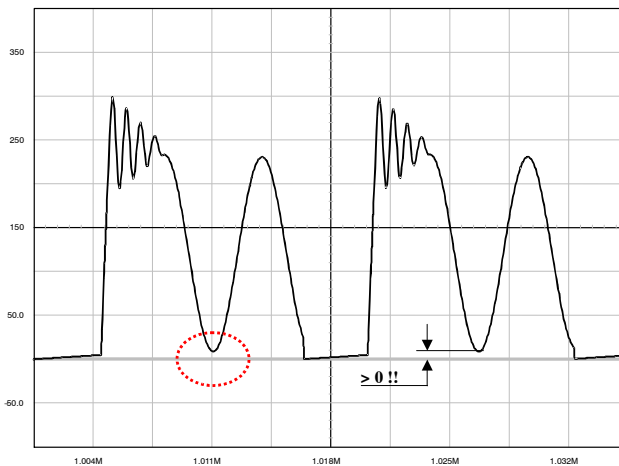

**Figure 38. The Drain-Source Wave Shall Always be Positive**



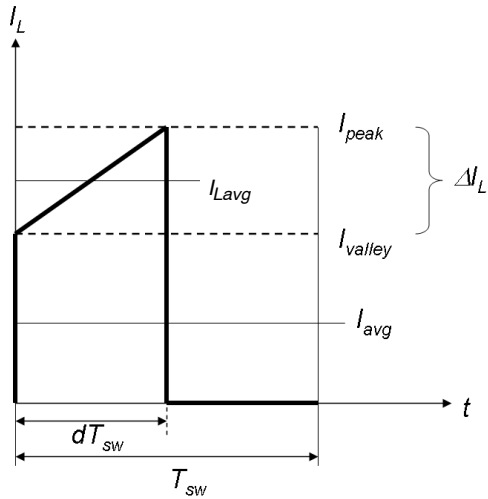

Figure 39. Primary Inductance Current Evolution in CCM

3. Lateral MOSFETs have a poorly doped body–diode which naturally limits their ability to sustain the avalanche. A traditional RCD clamping network shall thus be installed to protect the MOSFET. In some low power applications, a simple capacitor can also be used since

$$V_{\text{drain,max}} = V_{\text{in}} + N(V_{\text{out}} + V_f) + I_{\text{peak}} \sqrt{\frac{L_f}{C_{\text{tot}}}} \quad (\text{eq. 4})$$

where  $L_f$  is the leakage inductance,  $C_{\text{tot}}$  the total capacitance at the drain node (which is increased by the capacitor you will wire between drain and source),  $N$  the  $N_p:N_s$  turn ratio,  $V_{\text{out}}$  the output voltage,  $V_f$  the secondary diode forward drop and finally,  $I_{\text{peak}}$  the maximum peak current. Worst case occurs when the SMPS is very close to regulation, e.g. the  $V_{\text{out}}$  target is almost reached and  $I_{\text{peak}}$  is still pushed to the maximum. For this design, we have selected our maximum voltage around 650 V (at  $V_{\text{in}} = 375$  Vdc). This voltage is given by the RCD clamp installed from the drain to the bulk voltage. We will see how to calculate it later on.

4. Calculate the maximum operating duty–cycle for this flyback converter operated in CCM:

$$d_{\text{max}} = \frac{N(V_{\text{out}} + V_f)}{N(V_{\text{out}} + V_f) + V_{\text{in,min}}} = \frac{1}{1 + \frac{V_{\text{in,min}}}{N(V_{\text{out}} + V_f)}} = 0.44 \quad (\text{eq. 5})$$

5. To obtain the primary inductance, we have the choice between two equations:

$$L = \frac{(V_{\text{in}}d)^2}{f_{\text{sw}}KPI_{\text{in}}} \quad (\text{eq. 6})$$

where

$$K = \frac{\Delta I_L}{I_{\text{Lavg}}}$$

and defines the amount of ripple we want in CCM (see Figure 39).

- ♦ Small  $K$ : deep CCM, implying a large primary inductance, a low bandwidth and a large leakage inductance.
- ♦ Large  $K$ : approaching BCM where the rms losses are worse, but smaller inductance, leading to a better leakage inductance.

From Equation 6, a  $K$  factor of 1 (50% ripple), gives an inductance of:

$$L = \frac{(127 \times 0.44)^2}{65k \times 1 \times 12.75} = 3.8 \text{ mH}$$

$$\Delta I_L = \frac{V_{\text{in,min}} \cdot d_{\text{max}}}{LF_{\text{sw}}} = \frac{127 \times 0.44}{3.8 \times 65k}$$

$$= 223 \text{ mA peak-to-peak}$$

The peak current can be evaluated to be:

$$I_{\text{peak}} = \frac{I_{\text{avg}}}{d} + \frac{\Delta I_L}{2} = I_{\text{peak}} = \frac{98\text{m}}{0.44} + \frac{\Delta I_L}{2} = 335 \text{ mA}$$

On  $I_L$ ,  $I_{\text{Lavg}}$  can also be calculated:

$$I_{\text{Lavg}} = I_{\text{peak}} - \frac{\Delta I_L}{2} = 0.34 - 0.112 = 223 \text{ mA}$$

6. Based on the above numbers, we can now evaluate the conduction losses:

$$I_{\text{d,rms}} = \sqrt{d \left( I_{\text{peak}}^2 - I_{\text{peak}} \Delta I_L + \frac{\Delta I_L^2}{3} \right)} = \sqrt{0.44 \left( 0.335^2 - 0.335 \cdot 0.223 + \frac{0.223^2}{3} \right)} = 154 \text{ mA}$$

If we take the maximum  $R_{\text{ds(on)}}$  for a 125°C junction temperature, i.e. 24 Ω, then conduction losses worse case are:

$$P_{\text{cond}} = I_{\text{d,rms}}^2 R_{\text{DS(on)}} = 570 \text{ mW}$$

7. Off–time and on–time switching losses can be estimated based on the following calculations:

$$P_{\text{off}} = \frac{I_{\text{peak}}(V_{\text{bulk}} + V_{\text{clamp}})t_{\text{off}}}{2T_{\text{sw}}} = \frac{0.335 \times (127 + 120 \cdot 2) \times 10\text{n}}{2 \times 15.4\mu} = 36 \text{ mW} \quad (\text{eq. 7})$$

Where, assume the  $V_{clamp}$  is equal to two times of reflected voltage.

$$P_{on} = \frac{I_{valley}(V_{bulk} + N(V_{out} + V_f))t_{on}}{6T_{sw}} \quad (eq. 8)$$

$$= \frac{0.111 \times (127 + 100) \times 20n}{6 \times 15.4\mu}$$

$$= 5.5 \text{ mW}$$

It is noted that the overlap of voltage and current seen on MOSFET during turning on and off duration is dependent on the snubber and parasitic capacitance seen from drain pin. Therefore the  $t_{off}$  and  $t_{on}$  in Equations 7 and 8 have to be modified after measuring on the bench.

8. The theoretical total power is then  $0.570 + 0.036 + 0.0055 = 611 \text{ mW}$
9. If the NCP107X operates at DSS mode, then the losses caused by DSS mode should be counted as losses of this device on the following calculation:

$$P_{DSS} = I_{CC1} \cdot V_{in,max} = 1m \cdot 375 = 375 \text{ mW} \quad (eq. 9)$$

**MOSFET protection**

As in any Flyback design, it is important to limit the drain excursion to a safe value, e.g. below the MOSFET BV<sub>dss</sub> which is 700 V. Figure 40a, b, c present possible implementations:

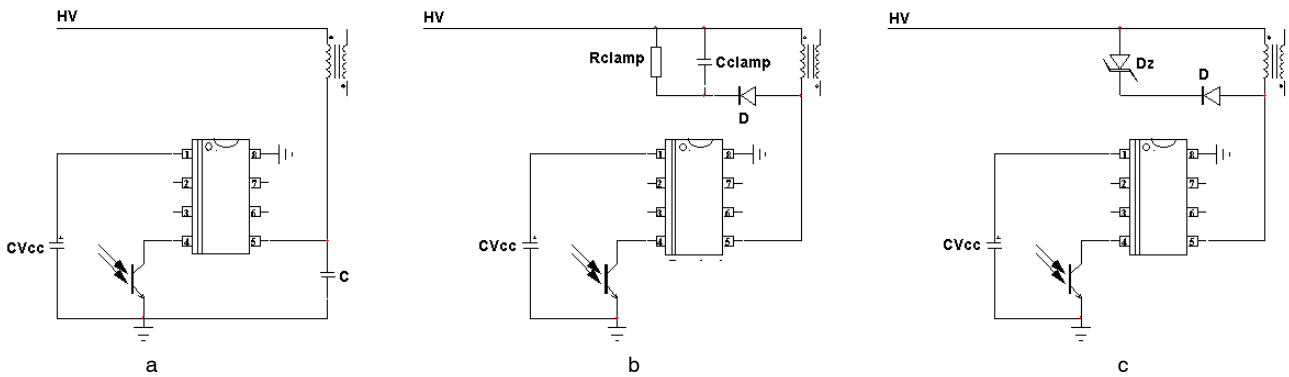

**Figure 40. Different Options to Clamp the Leakage Spike**

Figure 40a: the simple capacitor limits the voltage according to The lateral MOSFET body–diode shall never be forward biased, either during start–up (because of a large leakage inductance) or in normal operation as shown by Figure 38. This condition sets the maximum voltage that can be reflected during  $t_{off}$ . As a result, the Flyback voltage which is reflected on the drain at the switch opening cannot be larger than the input voltage. When selecting components, you thus must adopt a turn ratio which adheres to the following equation: Equation 3. This option is only valid for low power applications, e.g. below 5 W, otherwise chances exist to destroy the MOSFET. After evaluating the leakage inductance, you can compute C with Equation 4. Typical values are between 100 pF and up to 470 pF. Large capacitors increase capacitive losses...

Figure 40b: the most standard circuitry is called the RCD network. You calculate  $R_{clamp}$  and  $C_{clamp}$  using the following formulae:

$$R_{clamp} = \frac{2 V_{clamp}(V_{clamp} - (V_{out} + V_f)N)}{L_{leak} I_{peak}^2 F_{sw}} \quad (eq. 10)$$

$$C_{clamp} = \frac{V_{clamp}}{V_{ripple} F_{sw} R_{clamp}} \quad (eq. 11)$$

$V_{clamp}$  is usually selected 50–80 V above the reflected value  $N \times (V_{out} + V_f)$ . The diode needs to be a fast one and a MUR160 represents a good choice. One major drawback of the RCD network lies in its dependency upon the peak current. Worse case occurs when  $I_{peak}$  and  $V_{in}$  are maximum and  $V_{out}$  is close to reach the steady–state value.

Figure 40c: this option is probably the most expensive of all three but it offers the best protection degree. If you need a very precise clamping level, you must implement a zener diode or a TVS. There are little technology differences behind a standard zener diode and a TVS. However, the die area is far bigger for a transient suppressor than that of zener. A 5 W zener diode like the 1N5388B will accept 180 W peak power if it lasts less than 8.3 ms. If the peak current in the worse case (e.g. when the PWM circuit maximum current limit works) multiplied by the nominal zener voltage exceeds these 180 W, then the diode will be destroyed when the supply experiences overloads. A transient suppressor like the P6KE200 still dissipates 5 W of continuous power but is able to accept surges up to 600 W @ 1 ms. Select the zener or TVS clamping level between 40 to 80 V above the reflected output voltage when the supply is heavily loaded.

## NCP1070, NCP1071, NCP1072, NCP1075, NCP1076, NCP1077

### Power Dissipation and Heatsinking

The NCP107X welcomes two dissipating terms, the DSS current–source (when active) and the MOSFET. Thus,  $P_{tot} = P_{DSS} + P_{MOSFET}$ . It is mandatory to properly manage the heat generated by losses. If no precaution is taken, risks exist to trigger the internal thermal shutdown (TSD). To help dissipating the heat, the PCB designer must foresee large copper areas around the package. Take the PDIP–7 package as an example, when surrounded by a surface greater than  $1.0 \text{ cm}^2$  of  $35 \text{ }\mu\text{m}$  copper, it becomes possible to drop its thermal resistance junction–to–ambient,  $R_{\theta JA}$  down to

$75^\circ\text{C/W}$  and thus dissipate more power. The maximum power the device can thus evacuate is:

$$P_{max} = \frac{T_{Jmax} - T_{ambmax}}{R_{\theta JA}} \quad (\text{eq. 12})$$

which gives around 930 mW for an ambient of  $50^\circ\text{C}$  and a maximum junction of  $120^\circ\text{C}$ . If the surface is not large enough, assuming the  $R_{\theta JA}$  is  $100^\circ\text{C/W}$ , then the maximum power the device can evacuate becomes 700 mW. Figure 41 gives a possible layout to help drop the thermal resistance.

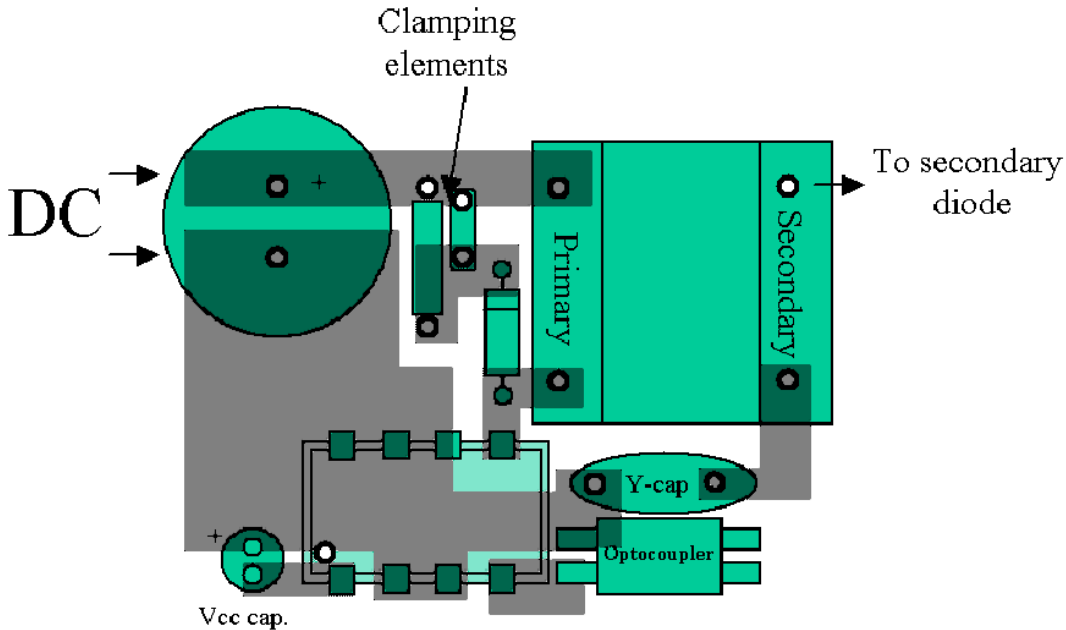

**Figure 41. A Possible PCB Arrangement to Reduce the Thermal Resistance Junction–to–Ambient**

### A 10 W NCP1075 based Flyback Converter Featuring Low Standby Power

Figure 43 depicts a typical application showing a NCP1075–65 kHz operating in a 10 W converter. To leave more room for the MOSFET, it is recommended to disable the DSS by shorting the J3. In this application, the feedback

is made via a NCP431 whose low bias current ( $50 \text{ }\mu\text{A}$ ) helps to lower the no load standby power.

Measurements have been taken from a demonstration board implementing the diagram in Figure 43 and the following results were achieved with auxiliary winding to bias the device:

|  | 100 Vac | 115 Vac | 230 Vac | 265 Vac |
|--|---------|---------|---------|---------|
| No load consumption with auxiliary winding | 26 mW   | 28 mW   | 38 mW   | 45 mW   |

NCP1070, NCP1071, NCP1072, NCP1075, NCP1076, NCP1077

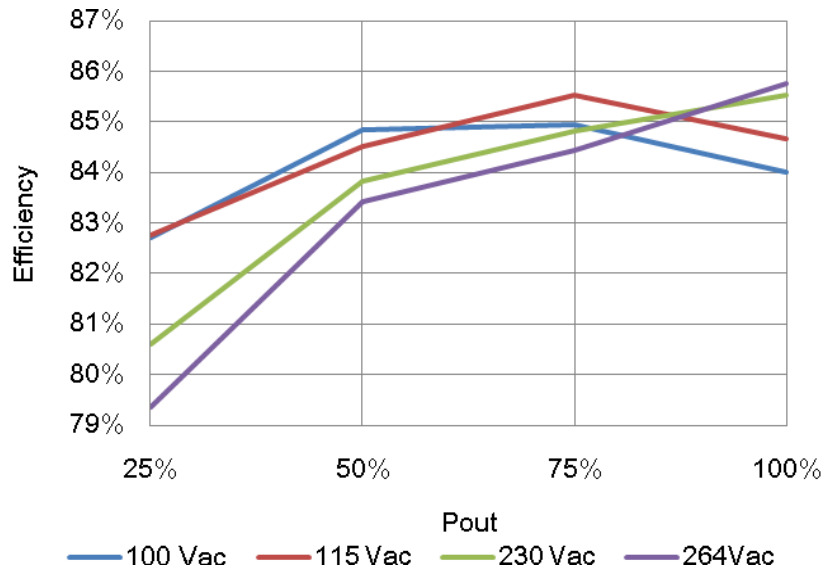

Figure 42. V<sub>out</sub> = 12 V

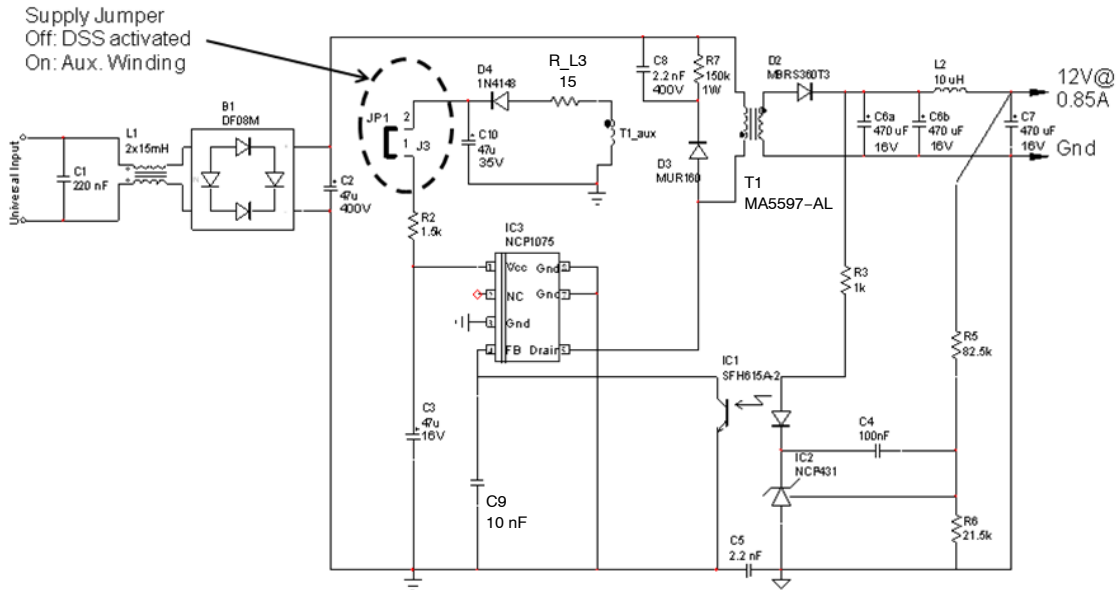

Figure 43. A 12 V – 0.85 A Universal Mains Power Supply

# NCP1070, NCP1071, NCP1072, NCP1075, NCP1076, NCP1077

## ORDERING INFORMATION

| Device        | Frequency | R <sub>DS(on)</sub> (Ω) | I <sub>pk</sub> (mA) | Package Type         | Shipping†            |
|---------------|-----------|-------------------------|----------------------|----------------------|----------------------|
| NCP1070STAT3G | 65 kHz    | 22                      | 250                  | SOT-223<br>(Pb-Free) | 4000 / Tape & Reel   |
| NCP1070STBT3G | 100 kHz   | 22                      | 250                  |                      | 4000 / Tape & Reel   |
| NCP1070STCT3G | 130 kHz   | 22                      | 250                  |                      | 4000 / Tape & Reel   |
| NCP1070P065G  | 65 kHz    | 22                      | 250                  | PDIP-7<br>(Pb-Free)  | 50 Units / Rail      |
| NCP1070P100G  | 100 kHz   | 22                      | 250                  |                      | 50 Units / Rail      |
| NCP1070P130G  | 130 kHz   | 22                      | 250                  |                      | 50 Units / Rail      |
| NCP1071STAT3G | 65 kHz    | 22                      | 350                  | SOT-223<br>(Pb-Free) | 4000 / Tape & Reel   |
| NCP1071STBT3G | 100 kHz   | 22                      | 350                  |                      | 4000 / Tape & Reel   |
| NCP1071STCT3G | 130 kHz   | 22                      | 350                  |                      | 4000 / Tape & Reel   |
| NCP1071P065G  | 65 kHz    | 22                      | 350                  | PDIP-7<br>(Pb-Free)  | 50 Units / Rail      |
| NCP1071P100G  | 100 kHz   | 22                      | 350                  |                      | 50 Units / Rail      |
| NCP1071P130G  | 130 kHz   | 22                      | 350                  |                      | 50 Units / Rail      |
| NCP1072STAT3G | 65 kHz    | 11                      | 250                  | SOT-223<br>(Pb-Free) | 4000 / Tape & Reel   |
| NCP1072STBT3G | 100 kHz   | 11                      | 250                  |                      | 4000 / Tape & Reel   |
| NCP1072P065G  | 65 kHz    | 11                      | 250                  |                      | 50 Units / Rail      |
| NCP1072P100G  | 100 kHz   | 11                      | 250                  | PDIP-7<br>(Pb-Free)  | 50 Units / Rail      |
| NCP1072P100BG | 100 kHz   | 11                      | 250                  |                      | 50 Units / Rail      |
| NCP1075STAT3G | 65 kHz    | 11                      | 450                  |                      | SOT-223<br>(Pb-Free) |
| NCP1075STBT3G | 100 kHz   | 11                      | 450                  | 4000 / Tape & Reel   |                      |
| NCP1075STCT3G | 130 kHz   | 11                      | 450                  | 4000 / Tape & Reel   |                      |
| NCP1075P065G  | 65 kHz    | 11                      | 450                  | PDIP-7<br>(Pb-Free)  | 50 Units / Rail      |
| NCP1075P100G  | 100 kHz   | 11                      | 450                  |                      | 50 Units / Rail      |
| NCP1075P130G  | 130 kHz   | 11                      | 450                  |                      | 50 Units / Rail      |
| NCP1076STAT3G | 65 kHz    | 4.7                     | 650                  | SOT-223<br>(Pb-Free) | 4000 / Tape & Reel   |
| NCP1076STBT3G | 100 kHz   | 4.7                     | 650                  |                      | 4000 / Tape & Reel   |
| NCP1076STCT3G | 130 kHz   | 4.7                     | 650                  |                      | 4000 / Tape & Reel   |
| NCP1076P065G  | 65 kHz    | 4.7                     | 650                  | PDIP-7<br>(Pb-Free)  | 50 Units / Rail      |
| NCP1076P100G  | 100 kHz   | 4.7                     | 650                  |                      | 50 Units / Rail      |
| NCP1076P130G  | 130 kHz   | 4.7                     | 650                  |                      | 50 Units / Rail      |
| NCP1077STAT3G | 65 kHz    | 4.7                     | 800                  | SOT-223<br>(Pb-Free) | 4000 / Tape & Reel   |
| NCP1077STBT3G | 100 kHz   | 4.7                     | 800                  |                      | 4000 / Tape & Reel   |
| NCP1077STCT3G | 130 kHz   | 4.7                     | 800                  |                      | 4000 / Tape & Reel   |
| NCP1077P065G  | 65 kHz    | 4.7                     | 800                  | PDIP-7<br>(Pb-Free)  | 50 Units / Rail      |
| NCP1077P100G  | 100 kHz   | 4.7                     | 800                  |                      | 50 Units / Rail      |
| NCP1077P130G  | 130 kHz   | 4.7                     | 800                  |                      | 50 Units / Rail      |

†For information on tape and reel specifications, including part orientation and tape sizes, please refer to our Tape and Reel Packaging Specifications Brochure, BRD8011/D.



SCALE 1:1

SOT-223 (TO-261)  
CASE 318E-04  
ISSUE R

DATE 02 OCT 2018

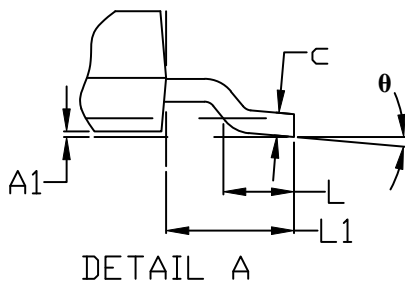
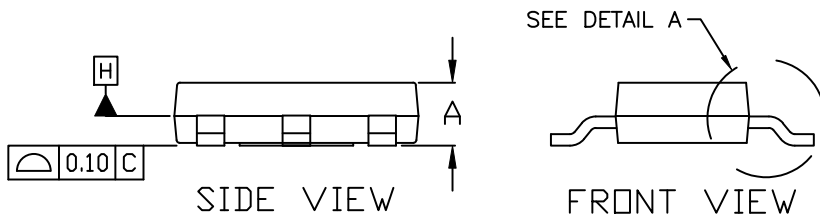
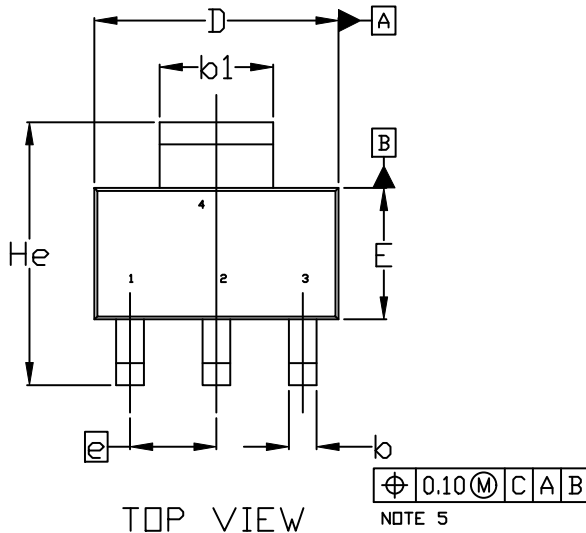

NOTES:

1. DIMENSIONING AND TOLERANCING PER ASME Y14.5M, 1994.
2. CONTROLLING DIMENSION: MILLIMETERS
3. DIMENSIONS D & E DO NOT INCLUDE MOLD FLASH, PROTRUSIONS OR GATE BURRS. MOLD FLASH, PROTRUSIONS OR GATE BURRS SHALL NOT EXCEED 0.200MM PER SIDE.
4. DATUMS A AND B ARE DETERMINED AT DATUM H.
5. A1 IS DEFINED AS THE VERTICAL DISTANCE FROM THE SEATING PLANE TO THE LOWEST POINT OF THE PACKAGE BODY.
6. POSITIONAL TOLERANCE APPLIES TO DIMENSIONS b AND b1.

| MILLIMETERS |          |      |      |
|-------------|----------|------|------|
| DIM         | MIN.     | NOM. | MAX. |
| A           | 1.50     | 1.63 | 1.75 |
| A1          | 0.02     | 0.06 | 0.10 |
| b           | 0.60     | 0.75 | 0.89 |
| b1          | 2.90     | 3.06 | 3.20 |
| c           | 0.24     | 0.29 | 0.35 |
| D           | 6.30     | 6.50 | 6.70 |
| E           | 3.30     | 3.50 | 3.70 |
| e           | 2.30 BSC |      |      |
| L           | 0.20     | ---  | ---  |
| L1          | 1.50     | 1.75 | 2.00 |
| He          | 6.70     | 7.00 | 7.30 |
| $\theta$    | 0°       | ---  | 10°  |

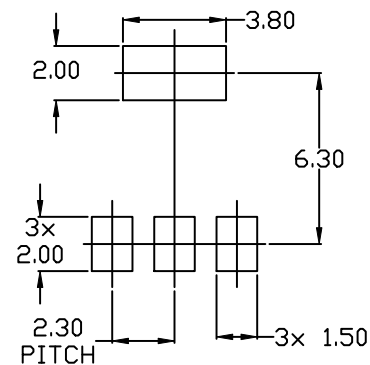

RECOMMENDED MOUNTING FOOTPRINT

|                  |                  |  |
|------------------|------------------|--|
| DOCUMENT NUMBER: | 98ASB42680B      | Electronic versions are uncontrolled except when accessed directly from the Document Repository. Printed versions are uncontrolled except when stamped "CONTROLLED COPY" in red. |
| DESCRIPTION:     | SOT-223 (TO-261) | PAGE 1 OF 2  |

onsemi and ONSEMI are trademarks of Semiconductor Components Industries, LLC dba onsemi or its subsidiaries in the United States and/or other countries. onsemi reserves the right to make changes without further notice to any products herein. onsemi makes no warranty, representation or guarantee regarding the suitability of its products for any particular purpose, nor does onsemi assume any liability arising out of the application or use of any product or circuit, and specifically disclaims any and all liability, including without limitation special, consequential or incidental damages. onsemi does not convey any license under its patent rights nor the rights of others.

**SOT-223 (TO-261)  
CASE 318E-04  
ISSUE R**

DATE 02 OCT 2018

- |  |   |   |   |   |
|--|---|---|---|---|
| <b>STYLE 1:</b><br>PIN 1. BASE<br>2. COLLECTOR<br>3. EMITTER<br>4. COLLECTOR | <b>STYLE 2:</b><br>PIN 1. ANODE<br>2. CATHODE<br>3. NC<br>4. CATHODE        | <b>STYLE 3:</b><br>PIN 1. GATE<br>2. DRAIN<br>3. SOURCE<br>4. DRAIN           | <b>STYLE 4:</b><br>PIN 1. SOURCE<br>2. DRAIN<br>3. GATE<br>4. DRAIN   | <b>STYLE 5:</b><br>PIN 1. DRAIN<br>2. GATE<br>3. SOURCE<br>4. GATE    |
| <b>STYLE 6:</b><br>PIN 1. RETURN<br>2. INPUT<br>3. OUTPUT<br>4. INPUT        | <b>STYLE 7:</b><br>PIN 1. ANODE 1<br>2. CATHODE<br>3. ANODE 2<br>4. CATHODE | <b>STYLE 8:</b><br>CANCELLED  | <b>STYLE 9:</b><br>PIN 1. INPUT<br>2. GROUND<br>3. LOGIC<br>4. GROUND | <b>STYLE 10:</b><br>PIN 1. CATHODE<br>2. ANODE<br>3. GATE<br>4. ANODE |
| <b>STYLE 11:</b><br>PIN 1. MT 1<br>2. MT 2<br>3. GATE<br>4. MT 2             | <b>STYLE 12:</b><br>PIN 1. INPUT<br>2. OUTPUT<br>3. NC<br>4. OUTPUT         | <b>STYLE 13:</b><br>PIN 1. GATE<br>2. COLLECTOR<br>3. EMITTER<br>4. COLLECTOR |   |   |

**GENERIC  
MARKING DIAGRAM\***

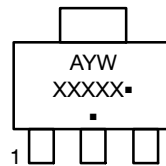

- A = Assembly Location
- Y = Year
- W = Work Week
- XXXXX = Specific Device Code
- = Pb-Free Package

(Note: Microdot may be in either location)

\*This information is generic. Please refer to device data sheet for actual part marking. Pb-Free indicator, "G" or microdot "▪", may or may not be present. Some products may not follow the Generic Marking.

|                         |                         |   |
|-------------------------|-------------------------|---|
| <b>DOCUMENT NUMBER:</b> | <b>98ASB42680B</b>      | Electronic versions are uncontrolled except when accessed directly from the Document Repository.<br>Printed versions are uncontrolled except when stamped "CONTROLLED COPY" in red. |
| <b>DESCRIPTION:</b>     | <b>SOT-223 (TO-261)</b> | <b>PAGE 2 OF 2</b>  |

**onsemi** and **ONSEMI** are trademarks of Semiconductor Components Industries, LLC dba **onsemi** or its subsidiaries in the United States and/or other countries. **onsemi** reserves the right to make changes without further notice to any products herein. **onsemi** makes no warranty, representation or guarantee regarding the suitability of its products for any particular purpose, nor does **onsemi** assume any liability arising out of the application or use of any product or circuit, and specifically disclaims any and all liability, including without limitation special, consequential or incidental damages. **onsemi** does not convey any license under its patent rights nor the rights of others.



PDIP-7 (PDIP-8 LESS PIN 6)  
CASE 626A  
ISSUE C

DATE 22 APR 2015

SCALE 1:1

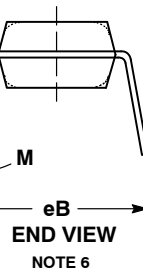
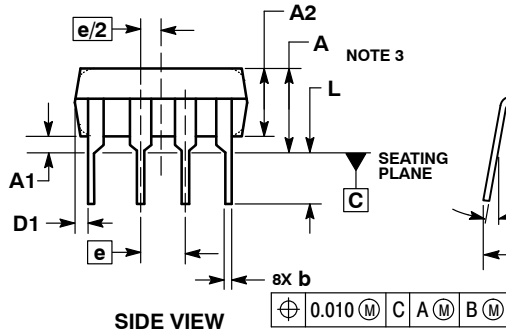
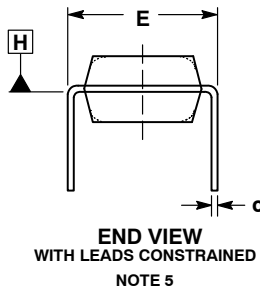
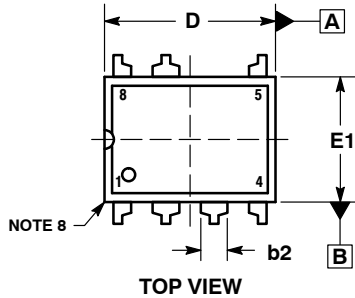

NOTES:

1. DIMENSIONING AND TOLERANCING PER ASME Y14.5M, 1994.
2. CONTROLLING DIMENSION: INCHES.
3. DIMENSIONS A, A1 AND L ARE MEASURED WITH THE PACKAGE SEATED IN JEDEC SEATING PLANE GAUGE GS-3.
4. DIMENSIONS D, D1 AND E1 DO NOT INCLUDE MOLD FLASH OR PROTRUSIONS. MOLD FLASH OR PROTRUSIONS ARE NOT TO EXCEED 0.10 INCH.
5. DIMENSION E IS MEASURED AT A POINT 0.015 BELOW DATUM PLANE H WITH THE LEADS CONSTRAINED PERPENDICULAR TO DATUM C.
6. DIMENSION eB IS MEASURED AT THE LEAD TIPS WITH THE LEADS UNCONSTRAINED.
7. DATUM PLANE H IS COINCIDENT WITH THE BOTTOM OF THE LEADS, WHERE THE LEADS EXIT THE BODY.
8. PACKAGE CONTOUR IS OPTIONAL (ROUNDED OR SQUARE CORNERS).

| DIM | INCHES    |       | MILLIMETERS |       |
|-----|-----------|-------|-------------|-------|
|     | MIN       | MAX   | MIN         | MAX   |
| A   | ----      | 0.210 | ----        | 5.33  |
| A1  | 0.015     | ----  | 0.38        | ----  |
| A2  | 0.115     | 0.195 | 2.92        | 4.95  |
| b   | 0.014     | 0.022 | 0.35        | 0.56  |
| b2  | 0.060 TYP |       | 1.52 TYP    |       |
| C   | 0.008     | 0.014 | 0.20        | 0.36  |
| D   | 0.355     | 0.400 | 9.02        | 10.16 |
| D1  | 0.005     | ----  | 0.13        | ----  |
| E   | 0.300     | 0.325 | 7.62        | 8.26  |
| E1  | 0.240     | 0.280 | 6.10        | 7.11  |
| e   | 0.100 BSC |       | 2.54 BSC    |       |
| eB  | ----      | 0.430 | ----        | 10.92 |
| L   | 0.115     | 0.150 | 2.92        | 3.81  |
| M   | ----      | 10°   | ----        | 10°   |

GENERIC MARKING DIAGRAM\*

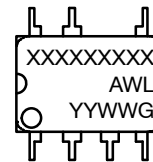

- XXXX = Specific Device Code
- A = Assembly Location
- WL = Wafer Lot
- YY = Year
- WW = Work Week
- G = Pb-Free Package

\*This information is generic. Please refer to device data sheet for actual part marking. Pb-Free indicator, "G" or microdot "•", may or may not be present. Some products may not follow the Generic Marking.

|                  |                            |  |
|------------------|----------------------------|--|
| DOCUMENT NUMBER: | 98AON11774D                | Electronic versions are uncontrolled except when accessed directly from the Document Repository. Printed versions are uncontrolled except when stamped "CONTROLLED COPY" in red. |
| DESCRIPTION:     | PDIP-7 (PDIP-8 LESS PIN 6) | PAGE 1 OF 1  |

onsemi and ONSEMI are trademarks of Semiconductor Components Industries, LLC dba onsemi or its subsidiaries in the United States and/or other countries. onsemi reserves the right to make changes without further notice to any products herein. onsemi makes no warranty, representation or guarantee regarding the suitability of its products for any particular purpose, nor does onsemi assume any liability arising out of the application or use of any product or circuit, and specifically disclaims any and all liability, including without limitation special, consequential or incidental damages. onsemi does not convey any license under its patent rights nor the rights of others.



**onsemi**, **Onsemi**, and other names, marks, and brands are registered and/or common law trademarks of Semiconductor Components Industries, LLC dba "**onsemi**" or its affiliates and/or subsidiaries in the United States and/or other countries. **onsemi** owns the rights to a number of patents, trademarks, copyrights, trade secrets, and other intellectual property. A listing of **onsemi**'s product/patent coverage may be accessed at [www.onsemi.com/site/pdf/Patent-Marking.pdf](http://www.onsemi.com/site/pdf/Patent-Marking.pdf). **onsemi** reserves the right to make changes at any time to any products or information herein, without notice. The information herein is provided "as-is" and **onsemi** makes no warranty, representation or guarantee regarding the accuracy of the information, product features, availability, functionality, or suitability of its products for any particular purpose, nor does **onsemi** assume any liability arising out of the application or use of any product or circuit, and specifically disclaims any and all liability, including without limitation special, consequential or incidental damages. Buyer is responsible for its products and applications using **onsemi** products, including compliance with all laws, regulations and safety requirements or standards, regardless of any support or applications information provided by **onsemi**. "Typical" parameters which may be provided in **onsemi** data sheets and/or specifications can and do vary in different applications and actual performance may vary over time. All operating parameters, including "Typicals" must be validated for each customer application by customer's technical experts. **onsemi** does not convey any license under any of its intellectual property rights nor the rights of others. **onsemi** products are not designed, intended, or authorized for use as a critical component in life support systems or any FDA Class 3 medical devices or medical devices with a same or similar classification in a foreign jurisdiction or any devices intended for implantation in the human body. Should Buyer purchase or use **onsemi** products for any such unintended or unauthorized application, Buyer shall indemnify and hold **onsemi** and its officers, employees, subsidiaries, affiliates, and distributors harmless against all claims, costs, damages, and expenses, and reasonable attorney fees arising out of, directly or indirectly, any claim of personal injury or death associated with such unintended or unauthorized use, even if such claim alleges that **onsemi** was negligent regarding the design or manufacture of the part. **onsemi** is an Equal Opportunity/Affirmative Action Employer. This literature is subject to all applicable copyright laws and is not for resale in any manner.

## ADDITIONAL INFORMATION

### TECHNICAL PUBLICATIONS:

Technical Library: [www.onsemi.com/design/resources/technical-documentation](http://www.onsemi.com/design/resources/technical-documentation)  
onsemi Website: [www.onsemi.com](http://www.onsemi.com)

### ONLINE SUPPORT: [www.onsemi.com/support](http://www.onsemi.com/support)

For additional information, please contact your local Sales Representative at [www.onsemi.com/support/sales](http://www.onsemi.com/support/sales)