

Octal D-Type Latch with 3-STATE Outputs

74VHC573



TSSOP20, 4.4x6.5
CASE 948AQ

General Description

The VHC573 is an advanced high speed CMOS octal latch with 3-STATE output fabricated with silicon gate CMOS technology. It achieves the high speed operation similar to equivalent Bipolar Schottky TTL while maintaining the CMOS low power dissipation. This 8-bit D-type latch is controlled by a latch enable input (LE) and an Output Enable input (\overline{OE}). When the \overline{OE} input is HIGH, the eight outputs are in a high impedance state.

An input protection circuit ensures that 0 V to 5.5 V can be applied to the input pins without regard to the supply voltage. This device can be used to interface 5 V to 3 V systems and two supply systems such as battery back up. This circuit prevents device destruction due to mismatched supply and input voltages.

Features

- High Speed: $t_{PD} = 5.0$ ns (Typ) at $V_{CC} = 5$ V
- High Noise Immunity: $V_{NIH} = V_{NIL} = 28\%$ V_{CC} (Min)
- Power Down Protection is Provided on All Inputs
- Low Noise: $V_{OLP} = 0.6$ V (Typ)
- Low Power Dissipation: $I_{CC} = 4$ μ A (Max) @ $T_A = 25$ °C
- Pin and Function Compatible with 74HC573
- This is a Pb-Free Device

Logic Symbol

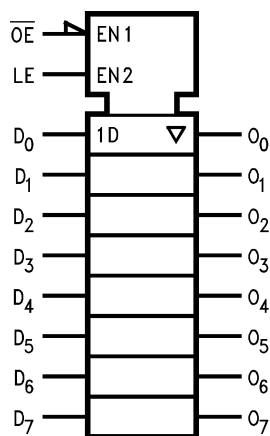
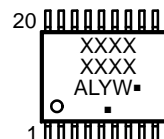

Figure 1. Logic Symbol

MARKING DIAGRAM



- XXXXXX = Specific Device Code
- A = Assembly Location
- L = Wafer Lot
- Y = Year
- W = Work Week
- = Pb-Free Package

(Note: Microdot may be in either location)

CONNECTION DIAGRAM

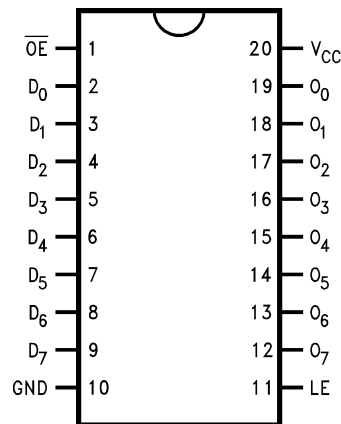

PIN DESCRIPTION

Pin Names	Description
D ₀ -D ₇	Data Inputs
LE	Latch Enable Input
\overline{OE}	3-STATE Output Enable Input
O ₀ -O ₇	3-STATE Outputs

ORDERING INFORMATION

See detailed ordering and shipping information in the package dimensions section on page 5 of this data sheet.

74VHC573

TRUTH TABLE

Inputs			Outputs
\overline{OE}	LE	D	O_n
L	H	H	H
L	H	L	L
L	L	X	O_0
H	X	X	Z

H = HIGH Voltage Level
 L = LOW Voltage Level
 X = Immaterial
 Z = High Impedance

Functional Description

The VHC573 contains eight D-type latches with 3-STATE output buffers. When the Latch Enable (LE) input is HIGH, data on the D_n inputs enters the latches. In this condition the latches are transparent, i.e., a latch output will change state each time its D input changes. When LE is LOW the latches store the information that was present on the D inputs, a setup time preceding the HIGH-to-LOW transition of LE. The 3-STATE buffers are controlled by the Output Enable (\overline{OE}) input. When \overline{OE} is LOW, the buffers are enabled. When \overline{OE} is HIGH the buffers are in the high impedance mode, but this does not interfere with entering new data into the latches.

Logic Diagram

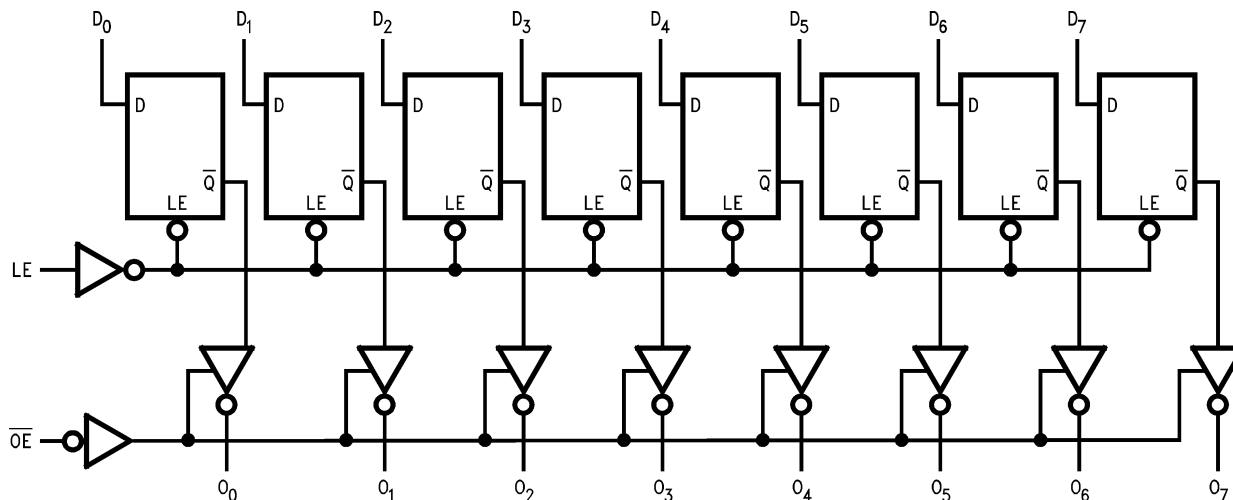

Please note that this diagram is provided only for the understanding of logic operations and should not be used to estimate propagation delays.

Figure 2. Logic Diagram

74VHC573

MAXIMUM RATINGS

Symbol	Parameter		Value	Unit
V _{CC}	DC Supply Voltage		-0.5 to +6.5	V
V _{IN}	DC Input Voltage		-0.5 to +6.5	V
V _{OUT}	DC Output Voltage		-0.5 to V _{CC} + 0.5	V
I _{IN}	DC Input Current		±20	mA
I _{OUT}	DC Output Current		±25	mA
I _{CC}	DC Supply Current, V _{CC} and GND Pins		±75	mA
I _{IK}	Input Clamp Current		-20	mA
I _{OK}	Output Clamp Current		±20	mA
T _{STG}	Storage Temperature Range		-65 to +150	°C
T _L	Lead Temperature, 1 mm from Case for 10 Seconds		260	°C
T _J	Junction Temperature under Bias		+150	°C
θ _{JA}	Thermal Resistance (Note 2)		150	°C/W
P _D	Power Dissipation in Still Air at 25 °C		833	mW
MSL	Moisture Sensitivity		Level 1	
F _R	Flammability Rating	Oxygen Index: 28 to 34	UL 94 V-0 @ 0.573 in	
V _{ESD}	ESD Withstand Voltage (Note 3)	Human Body Model	2000	V
		Charged Device Model	N/A	

Stresses exceeding those listed in the Maximum Ratings table may damage the device. If any of these limits are exceeded, device functionality should not be assumed, damage may occur and reliability may be affected.

1. Applicable to devices with outputs that may be tri-stated.
2. Measured with minimum pad spacing on an FR4 board, using 76 mm-by-114 mm, 2-ounce copper trace no air flow per JESD51-7.
3. HBM tested to EIA / JESD22-A114-A. CDM tested to JESD22-C101-A. JEDEC recommends that ESD qualification to EIA/JESD22-A115A (Machine Model) be discontinued.

RECOMMENDED OPERATING CONDITIONS

Symbol	Parameter		Min	Max	Unit
V _{CC}	DC Supply Voltage		2.0	5.5	V
V _{IN}	DC Input Voltage (Note 4)		0	5.5	V
V _{OUT}	DC Output Voltage (Note 4)		0	V _{CC}	V
T _A	Operating Temperature		-40	+85	°C
t _r , t _f	Input Rise or Fall Rate	V _{CC} = 3.0 V to 3.6 V	0	100	ns/V
		V _{CC} = 4.5 V to 5.5 V	0	20	

Functional operation above the stresses listed in the Recommended Operating Ranges is not implied. Extended exposure to stresses beyond the Recommended Operating Ranges limits may affect device reliability.

4. Unused inputs must always be tied to an appropriate logic voltage level (e.g., either GND or V_{CC}). Unused outputs must be left open.

74VHC573

DC ELECTRICAL CHARACTERISTICS

Symbol	Parameter	Conditions	V _{CC} (V)	T _A = 25 °C			T _A = -40 °C to +85 °C		Unit	
				Min	Typ	Max	Min	Max		
V _{IH}	HIGH Level Input Voltage		2.0	1.50	-	-	1.50	-	V	
			3.0-5.5	0.7 x V _{CC}	-	-	0.7 x V _{CC}	-		
V _{IL}	LOW Level Input Voltage		2.0	-	-	0.50	-	0.50	V	
			3.0-5.5	-	-	0.3 x V _{CC}	-	0.3 x V _{CC}		
V _{OH}	HIGH Level Output Voltage	V _{IN} = V _{IH} or V _{IL}	I _{OH} = -50 μA	2.0	1.9	2.0	-	1.9	-	V
				3.0	2.9	3.0	-	2.9	-	
				4.5	4.4	4.5	-	4.4	-	
			I _{OH} = -4 mA	3.0	2.58	-	-	2.48	-	
				4.5	3.94	-	-	3.80	-	
V _{OL}	LOW Level Output Voltage	V _{IN} = V _{IH} or V _{IL}	I _{OL} = 50 μA	2.0	-	0.0	0.1	-	0.1	V
				3.0	-	0.0	0.1	-	0.1	
				4.5	-	0.0	0.1	-	0.1	
			I _{OL} = 4 mA	3.0	-	-	0.36	-	0.44	
				4.5	-	-	0.36	-	0.44	
I _{OZ}	3-STATE Output Off-State Current	V _{IN} = V _{IH} or V _{IL} , V _{OUT} = V _{CC} or GND	5.5	-	-	±0.25	-	±2.5	μA	
I _{IN}	Input Leakage Current	V _{IN} = 5.5 V or GND	0-5.5	-	-	±0.1	-	±1.0	μA	
I _{CC}	Quiescent Supply Current	V _{IN} = V _{CC} or GND	5.5	-	-	4.0	-	40.0	μA	

NOISE CHARACTERISTICS

Symbol	Parameter	Conditions	V _{CC} (V)	T _A = 25 °C		Unit
				Typ	Limits	
V _{OLP} (Note 5)	Quiet Output Maximum Dynamic V _{OL}	C _L = 50 pF	5.0	0.9	1.2	V
V _{OLV} (Note 5)	Quiet Output Minimum Dynamic V _{OL}	C _L = 50 pF	5.0	-0.8	-1.0	V
V _{IHD} (Note 5)	Minimum HIGH Level Dynamic Input Voltage	C _L = 50 pF	5.0	-	3.5	V
V _{ILD} (Note 5)	Maximum LOW Level Dynamic Input Voltage	C _L = 50 pF	5.0	-	1.5	V

5. Parameter guaranteed by design.

74VHC573

AC ELECTRICAL CHARACTERISTICS

Symbol	Parameter	Conditions	V _{CC} (V)	T _A = 25 °C			T _A = -40 °C to +85 °C		Unit	
				Min	Typ	Max	Min	Max		
t _{PLH} , t _{PHL}	Propagation Delay Time (LE to O _n)		C _L = 15 pF	3.3 ± 0.3	-	7.6	11.9	1.0	14.0	ns
			C _L = 50 pF		-	10.1	15.4	1.0	17.5	
			C _L = 15 pF	5.0 ± 0.5	-	5.0	7.7	1.0	9.0	ns
			C _L = 50 pF		-	6.5	9.7	1.0	11.0	
t _{PLH} , t _{PHL}	Propagation Delay Time (D-O _n)		C _L = 15 pF	3.3 ± 0.3	-	7.0	11.0	1.0	13.0	ns
			C _L = 50 pF		-	9.5	14.5	1.0	16.5	
			C _L = 15 pF	5.0 ± 0.5	-	4.5	6.8	1.0	8.0	ns
			C _L = 50 pF		-	6.0	8.8	1.0	10.0	
t _{PZL} , t _{PZH}	3-STATE Output Enable Time	R _L = 1 kΩ	C _L = 15 pF	3.3 ± 0.3	-	7.3	11.5	1.0	13.5	ns
			C _L = 50 pF		-	9.8	15.0	1.0	17.0	
			C _L = 15 pF	5.0 ± 0.5	-	5.2	7.7	1.0	9.0	ns
			C _L = 50 pF		-	6.7	9.7	1.0	11.0	
t _{PLZ} , t _{PHZ}	3-STATE Output Disable Time	R _L = 1 kΩ	C _L = 50 pF	3.3 ± 0.3	-	10.7	14.5	1.0	16.5	ns
			C _L = 50 pF	5.0 ± 0.5	-	6.7	9.7	1.0	11.0	
t _{OSLH} , t _{OSHL}	Output to Output Skew	(Note 6)	C _L = 50 pF	3.3 ± 0.3	-	-	1.5	-	1.5	ns
			C _L = 50 pF	5.0 ± 0.5	-	-	1.0	-	1.0	
C _{IN}	Input Capacitance	V _{CC} = Open		-	4	10	-	10	pF	
C _{OUT}	Output Capacitance	V _{CC} = 5.0 V		-	6	-	-	-	pF	
C _{PD}	Power Dissipation Capacitance	(Note 7)		-	29	-	-	-	pF	

6. Parameter guaranteed by design. t_{OSLH} = |t_{PLH} max - t_{PLH} min|; t_{OSHL} = |t_{PHL} max - t_{PHL} min|

7. C_{PD} is defined as the value of the internal equivalent capacitance which is calculated from the operating current consumption without load. Average operating current can be obtained by the equation: I_{CC} (Opr.) = C_{PD} · V_{CC} · f_{IN} + I_{CC} / 8 (per Latch). The total C_{PD} when n pcs. of the Latch operates can be calculated by the equation: C_{PD} (total) = 21 + 8n.

AC OPERATING REQUIREMENTS

Symbol	Parameter	V _{CC} (V)	T _A = 25 °C			T _A = -40 °C to +85 °C		Unit
			Min	Typ	Max	Min	Max	
t _{W(H)} , t _{W(L)}	Minimum Pulse Width (LE)	3.3 ± 0.3	5.0	-	-	5.0	-	ns
		5.0 ± 0.5	5.0	-	-	5.0	-	
t _S	Minimum Setup Time	3.3 ± 0.3	3.5	-	-	3.5	-	ns
		5.0 ± 0.5	3.5	-	-	3.5	-	
t _H	Minimum Hold Time	3.3 ± 0.3	1.5	-	-	1.5	-	ns
		5.0 ± 0.5	1.5	-	-	1.5	-	

ORDERING INFORMATION

Device	Marking	Package	Shipping [†]
74VHC573MTC	VHC 573	TSSOP20 (Pb-Free)	75 Units / Tube
74VHC573MTCX	VHC 573	TSSOP20 (Pb-Free)	2500 Units / Tape & Reel

[†]For information on tape and reel specifications, including part orientation and tape sizes, please refer to our Tape and Reel Packaging Specifications Brochure, BRD8011/D.

TSSOP20, 4.4x6.5
CASE 948AQ
ISSUE A

DATE 19 MAR 2009

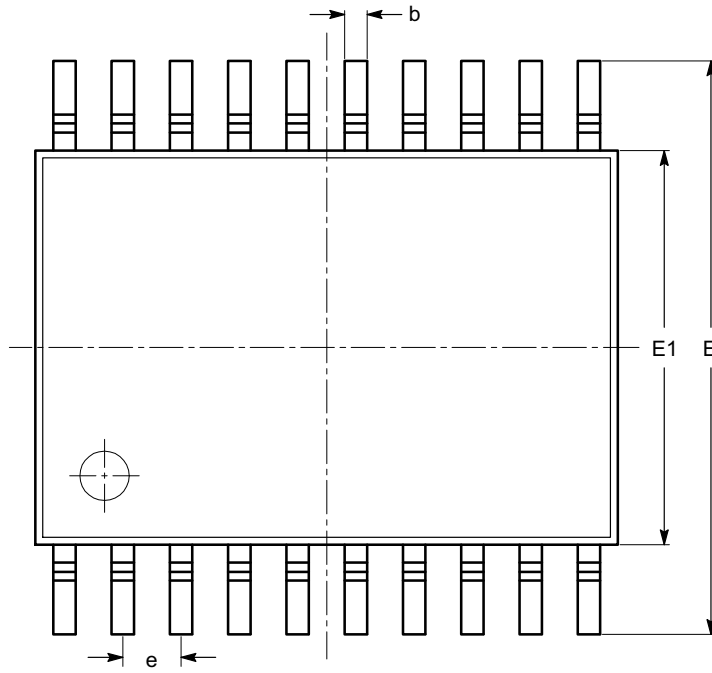

TOP VIEW

SYMBOL	MIN	NOM	MAX
A			1.20
A1	0.05		0.15
A2	0.80		1.05
b	0.19		0.30
c	0.09		0.20
D	6.40	6.50	6.60
E	6.30	6.40	6.50
E1	4.30	4.40	4.50
e	0.65 BSC		
L	0.45	0.60	0.75
L1	1.00 REF		
θ	0°		8°

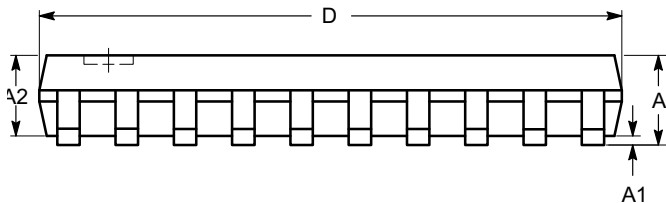

SIDE VIEW

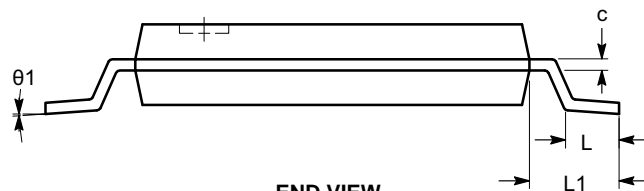

END VIEW

Notes:

- (1) All dimensions are in millimeters. Angles in degrees.
- (2) Complies with JEDEC MO-153.

DOCUMENT NUMBER:	98AON34453E	Electronic versions are uncontrolled except when accessed directly from the Document Repository. Printed versions are uncontrolled except when stamped "CONTROLLED COPY" in red.
DESCRIPTION:	TSSOP20, 4.4X6.5	PAGE 1 OF 1

onsemi and ONSEMI are trademarks of Semiconductor Components Industries, LLC dba onsemi or its subsidiaries in the United States and/or other countries. onsemi reserves the right to make changes without further notice to any products herein. onsemi makes no warranty, representation or guarantee regarding the suitability of its products for any particular purpose, nor does onsemi assume any liability arising out of the application or use of any product or circuit, and specifically disclaims any and all liability, including without limitation special, consequential or incidental damages. onsemi does not convey any license under its patent rights nor the rights of others.

onsemi, **Onsemi**, and other names, marks, and brands are registered and/or common law trademarks of Semiconductor Components Industries, LLC dba "**onsemi**" or its affiliates and/or subsidiaries in the United States and/or other countries. **onsemi** owns the rights to a number of patents, trademarks, copyrights, trade secrets, and other intellectual property. A listing of **onsemi**'s product/patent coverage may be accessed at www.onsemi.com/site/pdf/Patent-Marking.pdf. **onsemi** reserves the right to make changes at any time to any products or information herein, without notice. The information herein is provided "as-is" and **onsemi** makes no warranty, representation or guarantee regarding the accuracy of the information, product features, availability, functionality, or suitability of its products for any particular purpose, nor does **onsemi** assume any liability arising out of the application or use of any product or circuit, and specifically disclaims any and all liability, including without limitation special, consequential or incidental damages. Buyer is responsible for its products and applications using **onsemi** products, including compliance with all laws, regulations and safety requirements or standards, regardless of any support or applications information provided by **onsemi**. "Typical" parameters which may be provided in **onsemi** data sheets and/or specifications can and do vary in different applications and actual performance may vary over time. All operating parameters, including "Typicals" must be validated for each customer application by customer's technical experts. **onsemi** does not convey any license under any of its intellectual property rights nor the rights of others. **onsemi** products are not designed, intended, or authorized for use as a critical component in life support systems or any FDA Class 3 medical devices or medical devices with a same or similar classification in a foreign jurisdiction or any devices intended for implantation in the human body. Should Buyer purchase or use **onsemi** products for any such unintended or unauthorized application, Buyer shall indemnify and hold **onsemi** and its officers, employees, subsidiaries, affiliates, and distributors harmless against all claims, costs, damages, and expenses, and reasonable attorney fees arising out of, directly or indirectly, any claim of personal injury or death associated with such unintended or unauthorized use, even if such claim alleges that **onsemi** was negligent regarding the design or manufacture of the part. **onsemi** is an Equal Opportunity/Affirmative Action Employer. This literature is subject to all applicable copyright laws and is not for resale in any manner.

ADDITIONAL INFORMATION

TECHNICAL PUBLICATIONS:

Technical Library: www.onsemi.com/design/resources/technical-documentation
onsemi Website: www.onsemi.com

ONLINE SUPPORT: www.onsemi.com/support

For additional information, please contact your local Sales Representative at www.onsemi.com/support/sales