

ON Semiconductor

Is Now

onsemi™

To learn more about onsemi™, please visit our website at
www.onsemi.com

onsemi and **onsemi** and other names, marks, and brands are registered and/or common law trademarks of Semiconductor Components Industries, LLC dba "**onsemi**" or its affiliates and/or subsidiaries in the United States and/or other countries. **onsemi** owns the rights to a number of patents, trademarks, copyrights, trade secrets, and other intellectual property. A listing of **onsemi** product/patent coverage may be accessed at www.onsemi.com/site/pdf/Patent-Marking.pdf. **onsemi** reserves the right to make changes at any time to any products or information herein, without notice. The information herein is provided "as-is" and **onsemi** makes no warranty, representation or guarantee regarding the accuracy of the information, product features, availability, functionality, or suitability of its products for any particular purpose, nor does **onsemi** assume any liability arising out of the application or use of any product or circuit, and specifically disclaims any and all liability, including without limitation special, consequential or incidental damages. Buyer is responsible for its products and applications using **onsemi** products, including compliance with all laws, regulations and safety requirements or standards, regardless of any support or applications information provided by **onsemi**. "Typical" parameters which may be provided in **onsemi** data sheets and/or specifications can and do vary in different applications and actual performance may vary over time. All operating parameters, including "Typicals" must be validated for each customer application by customer's technical experts. **onsemi** does not convey any license under any of its intellectual property rights nor the rights of others. **onsemi** products are not designed, intended, or authorized for use as a critical component in life support systems or any FDA Class 3 medical devices or medical devices with a same or similar classification in a foreign jurisdiction or any devices intended for implantation in the human body. Should Buyer purchase or use **onsemi** products for any such unintended or unauthorized application, Buyer shall indemnify and hold **onsemi** and its officers, employees, subsidiaries, affiliates, and distributors harmless against all claims, costs, damages, and expenses, and reasonable attorney fees arising out of, directly or indirectly, any claim of personal injury or death associated with such unintended or unauthorized use, even if such claim alleges that **onsemi** was negligent regarding the design or manufacture of the part. **onsemi** is an Equal Opportunity/Affirmative Action Employer. This literature is subject to all applicable copyright laws and is not for resale in any manner. Other names and brands may be claimed as the property of others.

Single 2-Input Exclusive OR Gate

NLU1G86

The NLU1G86 MiniGate™ is an advanced high-speed CMOS 2-input Exclusive OR gate in ultra-small footprint.

The NLU1G86 input and output structures provide protection when voltages up to 7.0 V are applied, regardless of the supply voltage.

Features

- High Speed: $t_{PD} = 3.5 \text{ ns (Typ) @ } V_{CC} = 5.0 \text{ V}$
- Low Power Dissipation: $I_{CC} = 1 \mu\text{A (Max) at } T_A = 25^\circ\text{C}$
- Power Down Protection Provided on inputs
- Balanced Propagation Delays
- Overvoltage Tolerant (OVT) Input and Output Pins
- Ultra-Small Packages
- These are Pb-Free Devices

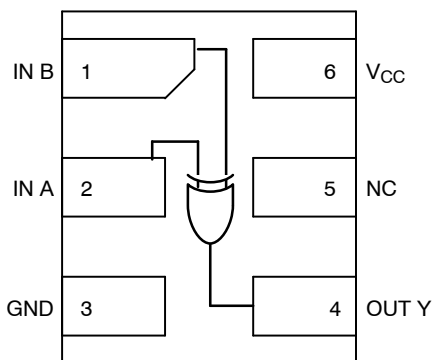

Figure 1. Pinout (Top View)

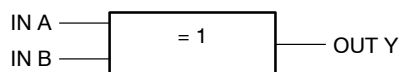

Figure 2. Logic Symbol

PIN ASSIGNMENT

| | |
|---|----------|
| 1 | IN B |
| 2 | IN A |
| 3 | GND |
| 4 | OUT Y |
| 5 | NC |
| 6 | V_{CC} |

FUNCTION TABLE

| Input | | Output |
|-------|---|--------|
| A | B | Y |
| L | L | L |
| L | H | H |
| H | L | H |
| H | H | L |



ON Semiconductor®

www.onsemi.com

MARKING DIAGRAMS



1

UDFN6
1.0 x 1.0
CASE 517BX



1

UDFN6
1.2 x 1.0
CASE 517AA



1

UDFN6
1.45 x 1.0
CASE 517AQ



Y,4,R = Device Marking
M = Date Code

ORDERING INFORMATION

See detailed ordering and shipping information in the package dimensions section on page 4 of this data sheet.

NLU1G86

MAXIMUM RATINGS

| Symbol | Parameter | Value | Unit |
|---------------|---|------------------------|-------------|
| V_{CC} | DC Supply Voltage | -0.5 to +7.0 | V |
| V_{IN} | DC Input Voltage | -0.5 to +7.0 | V |
| V_{OUT} | DC Output Voltage | -0.5 to +7.0 | V |
| I_{IK} | DC Input Diode Current $V_{IN} < GND$ | -20 | mA |
| I_{OK} | DC Output Diode Current $V_{OUT} < GND$ | ± 20 | mA |
| I_O | DC Output Source/Sink Current | ± 12.5 | mA |
| I_{CC} | DC Supply Current Per Supply Pin | ± 25 | mA |
| I_{GND} | DC Ground Current per Ground Pin | ± 25 | mA |
| T_{STG} | Storage Temperature Range | -65 to +150 | $^{\circ}C$ |
| T_L | Lead Temperature, 1 mm from Case for 10 Seconds | 260 | $^{\circ}C$ |
| T_J | Junction Temperature Under Bias | 150 | $^{\circ}C$ |
| MSL | Moisture Sensitivity | Level 1 | |
| F_R | Flammability Rating Oxygen Index: 28 to 34 | UL 94 V-0 @ 0.125 in | |
| V_{ESD} | ESD Withstand Voltage Human Body Model (Note 2) Machine Model (Note 3) Charged Device Model (Note 4) | > 2000 > 200 N/A | V |
| $I_{LATCHUP}$ | Latchup Performance Above V_{CC} and Below GND at 125 $^{\circ}C$ (Note 5) | ± 500 | mA |

Stresses exceeding those listed in the Maximum Ratings table may damage the device. If any of these limits are exceeded, device functionality should not be assumed, damage may occur and reliability may be affected.

1. Measured with minimum pad spacing on an FR4 board, using 10 mm-by-1 inch, 2 ounce copper trace no air flow.
2. Tested to EIA / JESD22-A114-A.
3. Tested to EIA / JESD22-A115-A.
4. Tested to JESD22-C101-A.
5. Tested to EIA / JESD78.

RECOMMENDED OPERATING CONDITIONS

| Symbol | Parameter | Min | Max | Unit |
|---------------------|--|--------|-----------|-------------|
| V_{CC} | Positive DC Supply Voltage | 1.65 | 5.5 | V |
| V_{IN} | Digital Input Voltage | 0 | 5.5 | V |
| V_{OUT} | Output Voltage | 0 | 5.5 | V |
| T_A | Operating Free-Air Temperature | -55 | +125 | $^{\circ}C$ |
| $\Delta t/\Delta V$ | Input Transition Rise or Fall Rate $V_{CC} = 3.3 V \pm 0.3 V$ $V_{CC} = 5.0 V \pm 0.5 V$ | 0 0 | 100 20 | ns/V |

NLU1G86

DC ELECTRICAL CHARACTERISTICS

| Symbol | Parameter | Conditions | V _{CC} (V) | T _A = 25 °C | | | T _A = +85°C | | T _A = -55°C to +125°C | | Unit |
|-----------------|---------------------------|--|---------------------|------------------------|-------------------|------------------------|------------------------|------------------------|----------------------------------|------------------------|------|
| | | | | Min | Typ | Max | Min | Max | Min | Max | |
| V _{IH} | Low-Level Input Voltage | | 1.65 | 0.75 x V _{CC} | | | 0.75 x V _{CC} | | | | V |
| | | | 2.3 to 5.5 | 0.70 x V _{CC} | | | 0.70 x V _{CC} | | | | |
| V _{IL} | Low-Level Input Voltage | | 1.65 | | | 0.25 x V _{CC} | | 0.25 x V _{CC} | | 0.25 x V _{CC} | V |
| | | | 2.3 to 5.5 | | | 0.30 x V _{CC} | | 0.30 x V _{CC} | | 0.30 x V _{CC} | |
| V _{OH} | High-Level Output Voltage | V _{IN} = V _{IH} or V _{IL} I _{OH} = -50 μA | 2.0 3.0 4.5 | 1.9 2.9 4.4 | 2.0 3.0 4.5 | | 1.9 2.9 4.4 | | 1.9 2.9 4.4 | | V |
| | | V _{IN} = V _{IH} or V _{IL} I _{OH} = -4 mA I _{OH} = -8 mA | 3.0 4.5 | 2.58 3.94 | | | 2.48 3.80 | | 2.34 3.66 | | |
| V _{OL} | Low-Level Output Voltage | V _{IN} = V _{IH} or V _{IL} I _{OL} = 50 μA | 2.0 3.0 4.5 | | 0 0 0 | 0.1 0.1 0.1 | | 0.1 0.1 0.1 | | 0.1 0.1 0.1 | V |
| | | V _{IN} = V _{IH} or V _{IL} I _{OL} = 4 mA I _{OL} = 8 mA | 3.0 4.5 | | | 0.36 0.36 | | 0.44 0.44 | | 0.52 0.52 | |
| I _{IN} | Input Leakage Current | 0 ≤ V _{IN} ≤ 5.5 V | 0 to 5.5 | | | ±0.1 | | ±1.0 | | ±1.0 | μA |
| I _{CC} | Quiescent Supply Current | 0 ≤ V _{IN} ≤ V _{CC} | 5.5 | | | 1.0 | | 10 | | 40 | μA |

AC ELECTRICAL CHARACTERISTICS (Input t_r = t_f = 3.0 nS)

| Symbol | Parameter | V _{CC} (V) | Test Condition | T _A = 25 °C | | | T _A = +85°C | | T _A = -55°C to +125°C | | Unit |
|--|---|---------------------|------------------------|------------------------|-----|------|------------------------|------|----------------------------------|------|------|
| | | | | Min | Typ | Max | Min | Max | Min | Max | |
| t _{PLH} , t _{PHL} | Propagation Delay, Input A or B to Output Y | 3.0 to 3.6 | C _L = 15 pF | | 4.4 | 11 | | 13 | | 15.5 | ns |
| | | | C _L = 50 pF | | 5.7 | 14.5 | | 16.5 | | 19.5 | |
| | | 4.5 to 5.5 | C _L = 15 pF | | 3.5 | 6.8 | | 8.0 | | 10 | |
| | | | C _L = 50 pF | | 4.2 | 8.8 | | 10 | | 12 | |
| C _{IN} | Input Capacitance | | | | 5.5 | 10 | | 10 | | 10 | pF |
| C _{PD} | Power Dissipation Capacitance (Note 6) | 5.0 | | | 10 | | | | | | pF |

6. C_{PD} is defined as the value of the internal equivalent capacitance which is calculated from the dynamic operating current consumption without load. Average operating current can be obtained by the equation I_{CC(OPR)} = C_{PD} • V_{CC} • f_{in} + I_{CC}. C_{PD} is used to determine the no-load dynamic power consumption: P_D = C_{PD} • V_{CC}² • f_{in} + I_{CC} • V_{CC}.

NLU1G86

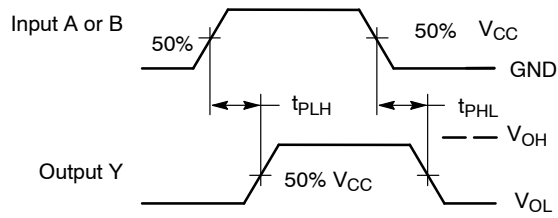
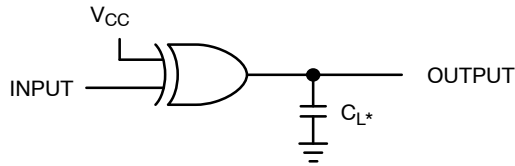

Figure 3. Switching Waveforms



*Includes all probe and jig capacitance.
A 1-MHz square input wave is recommended for propagation delay tests.

Figure 4. Test Circuit

ORDERING INFORMATION

| Device | Specific Device Code | Package | Shipping [†] |
|---------------|----------------------------|--------------------------------------|-----------------------|
| NLU1G86AMUTCG | R (Rotated 270 degrees) | UDFN6, 1.45 x 1.0, 0.5P (Pb-Free) | 3000 / Tape & Reel |
| NLU1G86MUTCG | 4 | UDFN6, 1.2 x 1.0, 0.4P (Pb-Free) | 3000 / Tape & Reel |
| NLU1G86CMUTCG | Y (Rotated 180 degrees) | UDFN6, 1.0 x 1.0, 0.35P (Pb-Free) | 3000 / Tape & Reel |

[†]For information on tape and reel specifications, including part orientation and tape sizes, please refer to our Tape and Reel Packaging Specifications Brochure, BRD8011/D.

NLU1G86

PACKAGE DIMENSIONS

UDFN6, 1.2x1.0, 0.4P
CASE 517AA
ISSUE D

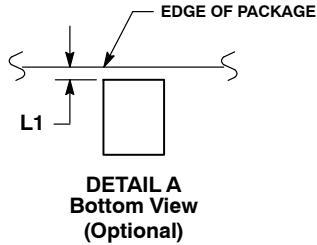
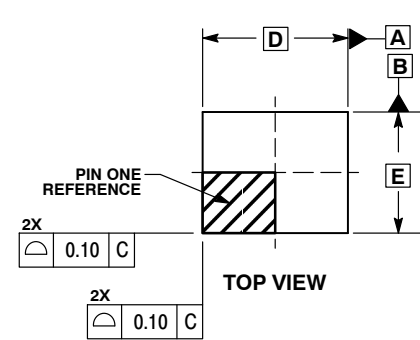

- NOTES:
1. DIMENSIONING AND TOLERANCING PER ASME Y14.5M, 1994.
 2. CONTROLLING DIMENSION: MILLIMETERS.
 3. DIMENSION b APPLIES TO PLATED TERMINAL AND IS MEASURED BETWEEN 0.25 AND 0.30 mm FROM TERMINAL.
 4. COPLANARITY APPLIES TO THE EXPOSED PAD AS WELL AS THE TERMINALS.

| MILLIMETERS | | |
|-------------|-------|------|
| DIM | MIN | MAX |
| A | 0.45 | 0.55 |
| A1 | 0.00 | 0.05 |
| A3 | 0.127 | REF |
| b | 0.15 | 0.25 |
| D | 1.20 | BSC |
| E | 1.00 | BSC |
| e | 0.40 | BSC |
| L | 0.30 | 0.40 |
| L1 | 0.00 | 0.15 |
| L2 | 0.40 | 0.50 |

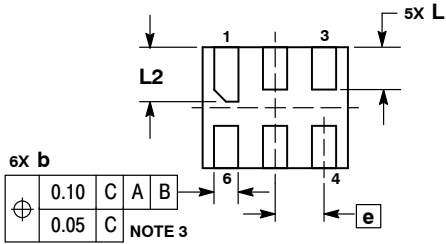
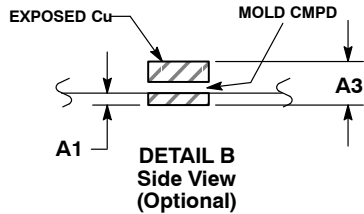
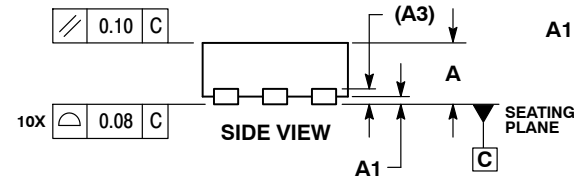

MOUNTING FOOTPRINT*

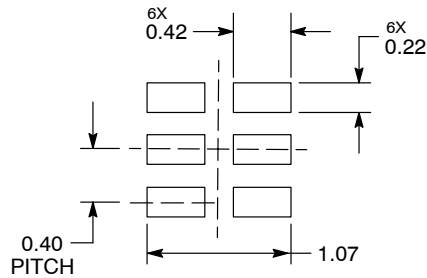

DIMENSIONS: MILLIMETERS

*For additional information on our Pb-Free strategy and soldering details, please download the ON Semiconductor Soldering and Mounting Techniques Reference Manual, SOLDERRM/D.

NLU1G86

PACKAGE DIMENSIONS

UDFN6 1.45x1.0, 0.5P
CASE 517AQ
ISSUE O

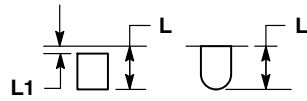
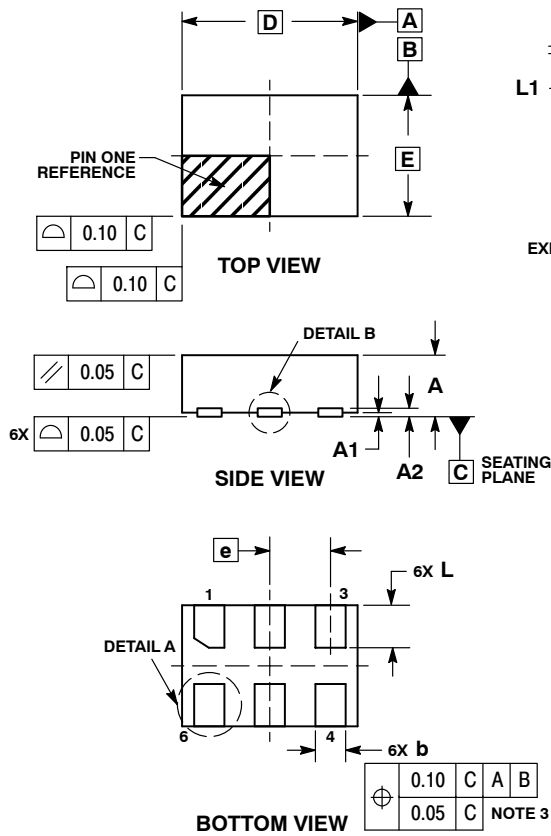

DETAIL A
OPTIONAL
CONSTRUCTIONS

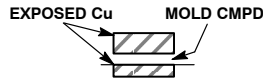

DETAIL B
OPTIONAL
CONSTRUCTIONS

NOTES:

1. DIMENSIONING AND TOLERANCING PER ASME Y14.5M, 1994.
2. CONTROLLING DIMENSION: MILLIMETERS.
3. DIMENSION b APPLIES TO PLATED TERMINAL AND IS MEASURED BETWEEN 0.15 AND 0.30 mm FROM THE TERMINAL TIP.

| DIM | MILLIMETERS | |
|-----|-------------|------|
| | MIN | MAX |
| A | 0.45 | 0.55 |
| A1 | 0.00 | 0.05 |
| A2 | 0.07 REF | |
| b | 0.20 | 0.30 |
| D | 1.45 BSC | |
| E | 1.00 BSC | |
| e | 0.50 BSC | |
| L | 0.30 | 0.40 |
| L1 | --- | 0.15 |

MOUNTING FOOTPRINT

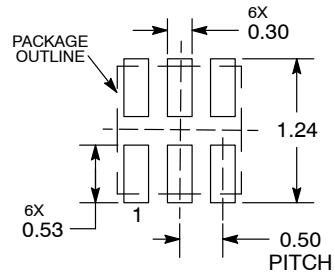

DIMENSIONS: MILLIMETERS

*For additional information on our Pb-Free strategy and soldering details, please download the ON Semiconductor Soldering and Mounting Techniques Reference Manual, SOLDERRM/D.

NLU1G86

PACKAGE DIMENSIONS

UDFN6 1.0x1.0, 0.35P
CASE 517BX
ISSUE O

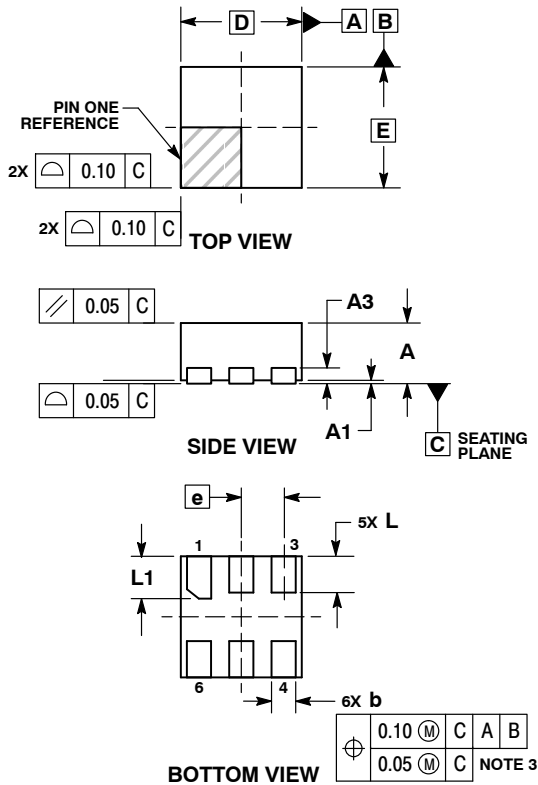

NOTES:

1. DIMENSIONING AND TOLERANCING PER ASME Y14.5M, 1994.
2. CONTROLLING DIMENSION: MILLIMETERS.
3. DIMENSION b APPLIES TO PLATED TERMINAL AND IS MEASURED BETWEEN 0.15 AND 0.20 MM FROM TERMINAL TIP.
4. PACKAGE DIMENSIONS EXCLUSIVE OF BURRS AND MOLD FLASH.

| MILLIMETERS | | |
|-------------|----------|------|
| DIM | MIN | MAX |
| A | 0.45 | 0.55 |
| A1 | 0.00 | 0.05 |
| A3 | 0.13 REF | |
| b | 0.12 | 0.22 |
| D | 1.00 BSC | |
| E | 1.00 BSC | |
| e | 0.35 BSC | |
| L | 0.25 | 0.35 |
| L1 | 0.30 | 0.40 |

RECOMMENDED SOLDERING FOOTPRINT*

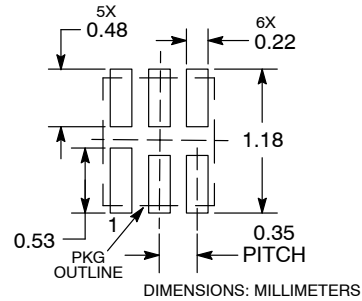

*For additional information on our Pb-Free strategy and soldering details, please download the ON Semiconductor Soldering and Mounting Techniques Reference Manual, SOLDERRM/D.

MiniGate is a trademark of Semiconductor Components Industries, LLC (SCILLC).

ON Semiconductor and are trademarks of Semiconductor Components Industries, LLC dba ON Semiconductor or its subsidiaries in the United States and/or other countries. ON Semiconductor owns the rights to a number of patents, trademarks, copyrights, trade secrets, and other intellectual property. A listing of ON Semiconductor's product/patent coverage may be accessed at www.onsemi.com/site/pdf/Patent-Marking.pdf. ON Semiconductor reserves the right to make changes without further notice to any products herein. ON Semiconductor makes no warranty, representation or guarantee regarding the suitability of its products for any particular purpose, nor does ON Semiconductor assume any liability arising out of the application or use of any product or circuit, and specifically disclaims any and all liability, including without limitation special, consequential or incidental damages. Buyer is responsible for its products and applications using ON Semiconductor products, including compliance with all laws, regulations and safety requirements or standards, regardless of any support or applications information provided by ON Semiconductor. "Typical" parameters which may be provided in ON Semiconductor data sheets and/or specifications can and do vary in different applications and actual performance may vary over time. All operating parameters, including "Typicals" must be validated for each customer application by customer's technical experts. ON Semiconductor does not convey any license under its patent rights nor the rights of others. ON Semiconductor products are not designed, intended, or authorized for use as a critical component in life support systems or any FDA Class 3 medical devices or medical devices with a same or similar classification in a foreign jurisdiction or any devices intended for implantation in the human body. Should Buyer purchase or use ON Semiconductor products for any such unintended or unauthorized application, Buyer shall indemnify and hold ON Semiconductor and its officers, employees, subsidiaries, affiliates, and distributors harmless against all claims, costs, damages, and expenses, and reasonable attorney fees arising out of, directly or indirectly, any claim of personal injury or death associated with such unintended or unauthorized use, even if such claim alleges that ON Semiconductor was negligent regarding the design or manufacture of the part. ON Semiconductor is an Equal Opportunity/Affirmative Action Employer. This literature is subject to all applicable copyright laws and is not for resale in any manner.

PUBLICATION ORDERING INFORMATION

LITERATURE FULFILLMENT:
Email Requests to: orderlit@onsemi.com

TECHNICAL SUPPORT
North American Technical Support:
Voice Mail: 1 800-282-9855 Toll Free USA/Canada
Phone: 011 421 33 790 2910

Europe, Middle East and Africa Technical Support:
Phone: 00421 33 790 2910
For additional information, please contact your local Sales Representative