

SN74AHC1G14 Single Schmitt-Trigger Inverter Gate

1 Features

- Operating range 2 V to 5.5 V
- Maximum t_{pd} of 10 ns at 5 V
- Low power consumption, 10- μ A max I_{CC}
- \pm 8-mA output drive at 5 V
- Latch-up performance exceeds 250 mA per JESD 17

2 Applications

- Barcode Scanners
- Cable Solutions
- E-Books
- Embedded PCs
- Field Transmitter: Temperature or Pressure Sensors
- Fingerprint Biometrics
- HVAC: Heating, Ventilating, and Air Conditioning
- Network-Attached Storage (NAS)
- Server Motherboard and PSU
- Software Defined Radios (SDR)
- TV: High Definition (HDTV), LCD, and Digital
- Video Communications Systems
- Wireless Data Access Cards, Headsets, Keyboards, Mice, and LAN Cards

3 Description

The SN74AHC1G14 device is a single inverter gate. The device performs the Boolean function $Y = \bar{A}$.

Package Information

PART NUMBER	PACKAGE ⁽¹⁾	PACKAGE SIZE ⁽²⁾	BODY SIZE ⁽³⁾
SN74AHC1G14	DBV (SOT-23, 5)	2.8 mm × 2.8 mm	2.9 mm × 1.6 mm
	DCK (SC-70, 5)	2 mm × 2.1 mm	2 mm × 1.25 mm
	DRL (SOT-553, 5)	1.6 mm × 1.6 mm	1.6 mm × 1.2 mm

- (1) For all available packages, see the orderable addendum at the end of the data sheet.
- (2) The package size (length × width) is a nominal value and includes pins, where applicable.
- (3) The body size (length × width) is a nominal value and does not include pins.

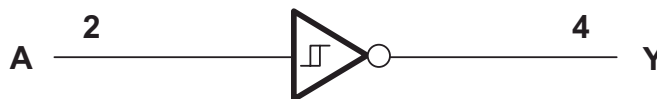

Logic Diagram (Positive Side)



Table of Contents

1 Features	1	7.2 Functional Block Diagram.....	8
2 Applications	1	7.3 Feature Description.....	8
3 Description	1	7.4 Device Functional Modes.....	8
4 Pin Configuration and Functions	3	8 Application and Implementation	9
5 Specifications	4	8.1 Application Information.....	9
5.1 Absolute Maximum Ratings.....	4	8.2 Typical Application.....	9
5.2 ESD Ratings.....	4	8.3 Power Supply Recommendations.....	10
5.3 Recommended Operating Conditions.....	4	8.4 Layout.....	10
5.4 Thermal Information.....	5	9 Device and Documentation Support	12
5.5 Electrical Characteristics.....	5	9.1 Documentation Support (Analog).....	12
5.6 Switching Characteristics, $V_{CC} = 3.3\text{ V} \pm 0.3\text{ V}$	6	9.2 Support Resources.....	12
5.7 Switching Characteristics, $V_{CC} = 5\text{ V} \pm 0.5\text{ V}$	6	9.3 Trademarks.....	12
5.8 Operating Characteristics.....	6	9.4 Electrostatic Discharge Caution.....	12
5.9 Typical Characteristics.....	6	9.5 Glossary.....	12
6 Parameter Measurement Information	7	10 Revision History	12
7 Detailed Description	8	11 Mechanical, Packaging, and Orderable Information	12
7.1 Overview.....	8		

4 Pin Configuration and Functions

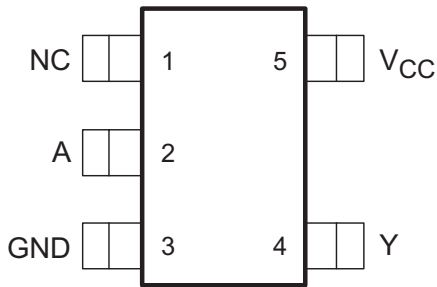

Figure 4-1. DBV Package 5-Pin SOT-23 Top View

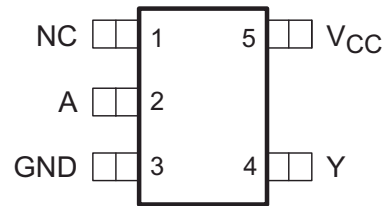

Figure 4-2. DCK Package 5-Pin SC70 Top View

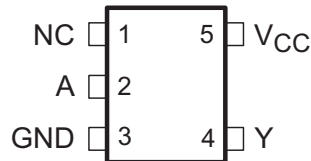

Figure 4-3. DRL Package 5-Pin SOT Top View

Table 4-1. Pin Functions

PIN		TYPE ⁽¹⁾	DESCRIPTION
NO.	NAME		
1	NC	—	No connect
2	A	I	Data Input
3	GND	—	Ground
4	Y	O	Data Output
5	VCC	—	Power

(1) Signal Types: I = Input, O = Output, I/O = Input or Output

5 Specifications

5.1 Absolute Maximum Ratings

over operating free-air temperature range (unless otherwise noted)⁽¹⁾

			MIN	MAX	UNIT
V _{CC}	Supply voltage		-0.5	7	V
V _I	Input voltage ⁽²⁾		-0.5	7	V
V _O	Output voltage ⁽²⁾		-0.5	V _{CC} + 0.5	V
I _{IK}	Input clamp current	V _I < 0		-20	mA
I _{OK}	Output clamp current	V _O < 0 or V _O > V _{CC}		±20	mA
I _O	Continuous output current	V _O = 0 to V _{CC}		±25	mA
	Continuous current through V _{CC} or GND			±50	mA
T _j	Maximum junction temperature			150	°C
T _{stg}	Storage temperature		-65	150	°C

- (1) Stresses beyond those listed under *Absolute Maximum Ratings* may cause permanent damage to the device. These are stress ratings only, and functional operation of the device at these or any other conditions beyond those indicated under *Recommended Operating Conditions* is not implied. Exposure to absolute-maximum-rated conditions for extended periods may affect device reliability.
- (2) The input and output voltage ratings may be exceeded if the input and output current ratings are observed.

5.2 ESD Ratings

			VALUE	UNIT
V _(ESD)	Electrostatic discharge	Human body model (HBM), per ANSI/ESDA/JEDEC JS-001, all pins ⁽¹⁾	±1500	V
		Charged-device model (CDM), per JEDEC specification JESD22-C101, all pins ⁽²⁾	±1000	

- (1) JEDEC document JEP155 states that 500-V HBM allows safe manufacturing with a standard ESD control process.
- (2) JEDEC document JEP157 states that 250-V CDM allows safe manufacturing with a standard ESD control process.

5.3 Recommended Operating Conditions

over operating free-air temperature range (unless otherwise noted)⁽¹⁾

			MIN	MAX	UNIT
V _{CC}	Supply voltage		2	5.5	V
V _I	Input voltage		0	5.5	V
V _O	Output voltage		0	V _{CC}	V
I _{OH}	High-level output current	V _{CC} = 2 V		-50	µA
		V _{CC} = 3.3 V ± 0.3 V		-4	mA
		V _{CC} = 5 V ± 0.5 V		-8	
I _{OL}	Low-level output current	V _{CC} = 2 V		50	µA
		V _{CC} = 3.3 V ± 0.3 V		4	mA
		V _{CC} = 5 V ± 0.5 V		8	
T _A	Operating free-air temperature		-40	125	°C

- (1) All unused inputs of the device must be held at V_{CC} or GND to ensure proper device operation. Refer to the TI application report, *Implications of Slow or Floating CMOS Inputs*, [SCBA004](#).

5.4 Thermal Information

THERMAL METRIC ⁽¹⁾		SN74AHC1G14			UNIT
		DBV (SOT-23)	DCK (SC70)	DRL (SOT)	
		5 PINS	5 PINS	5 PINS	
R _{θJA}	Junction-to-ambient thermal resistance	278	289.2	271.8	°C/W
R _{θJC(top)}	Junction-to-case (top) thermal resistance	180.5	205.8	116.6	°C/W
R _{θJB}	Junction-to-board thermal resistance	184.4	176.2	89.9	°C/W
ψ _{JT}	Junction-to-top characterization parameter	115.4	117.6	17.3	°C/W
ψ _{JB}	Junction-to-board characterization parameter	183.4	175.1	89.4	°C/W
R _{θJC(bot)}	Junction-to-case (bot) thermal resistance	N/A	N/A	N/A	°C/W

(1) For more information about traditional and new thermal metrics, see the *Semiconductor and IC Package Thermal Metrics* application report, [SPRA953](#).

5.5 Electrical Characteristics

over operating free-air temperature range (unless otherwise noted)

PARAMETER	TEST CONDITIONS	V _{CC}	T _A = 25°C			T _A = –40°C to 85°C			RECOMMENDED T _A = –40°C to 125°C			UNIT
			MIN	TYP	MAX	MIN	TYP	MAX	MIN	TYP	MAX	
V _{T+}	Positive-going input threshold voltage	3 V	1.2		2.2	1.2		2.2	1.2		2.2	V
		4.5 V	1.75		3.15	1.75		3.15	1.75		3.15	
		5.5 V	2.15		3.85	2.15		2.85	2.15		3.85	
V _{T–}	Negative-going input threshold voltage	3 V	0.9		1.9	0.9		1.9	0.9		1.9	V
		4.5 V	1.35		2.75	1.35		2.75	1.35		2.75	
		5.5 V	1.65		3.35	1.65		3.35	1.65		3.35	
ΔV _T	Hysteresis (V _{T+} – V _{T–})	3 V	0.3		1.2	0.3		1.2	0.25		1.2	V
		4.5 V	0.4		1.4	0.4		1.4	0.35		1.4	
		5.5 V	0.5		1.6	0.5		1.6	0.45		1.6	
V _{OH}	High level output voltage	I _{OH} = –50 μA	2 V	1.9	2		1.9			1.9		V
			3 V	2.9	3		2.9			2.9		
			4.5 V	4.4	4.5		4.4			4.4		
		I _{OH} = –4 mA	3 V	2.58			2.48			2.4		
		I _{OL} = –8 mA	4.5 V	3.94			3.8			3.7		
V _{OL}	Low level output voltage	I _{OH} = 50 μA	2 V			0.1			0.1		0.1	V
			3 V			0.1			0.1		0.1	
			4.5 V			0.1			0.1		0.1	
		I _{OH} = 4 mA	3 V			0.36			0.44		0.55	
		I _{OL} = 8 mA	4.5 V			0.36			0.44		0.55	
I _I	Input leakage current	V _I = 5.5 V or GND	0 V to 5.5 V							±0.1	±1	μA
I _{CC}	Supply current	V _I = V _{CC} or GND, I _O = 0	5.5 V							1	10	μA
C _i	Input Capacitance	V _I = V _{CC} or GND	5 V		2	10					10	pF

5.6 Switching Characteristics, $V_{CC} = 3.3\text{ V} \pm 0.3\text{ V}$

over recommended operating free-air temperature range (unless otherwise noted) (see [Load Circuit and Voltage Waveforms](#))

PARAMETER	FROM (INPUT)	TO (OUTPUT)	OUTPUT CAPACITANCE	$T_A = 25^\circ\text{C}$		$T_A = -40^\circ\text{C to } 85^\circ\text{C}$		RECOMMENDED $T_A = -40^\circ\text{C to } 125^\circ\text{C}$		UNIT
				TYP	MAX	MIN	MAX	MIN	MAX	
t_{PLH}	A	Y	$C_L = 15\text{ pF}$	8.3	12.8	1	15	1	16	ns
t_{PHL}				8.3	12.8	1	15	1	16	ns
t_{PLH}	A	Y	$C_L = 50\text{ pF}$	10.8	16.3	1	18.5	1	19.5	ns
t_{PHL}				10.8	16.3	1	18.5	1	19.5	ns

5.7 Switching Characteristics, $V_{CC} = 5\text{ V} \pm 0.5\text{ V}$

over recommended operating free-air temperature range (unless otherwise noted) (see [Load Circuit and Voltage Waveforms](#))

PARAMETER	FROM (INPUT)	TO (OUTPUT)	OUTPUT CAPACITANCE	$T_A = 25^\circ\text{C}$		$T_A = -40^\circ\text{C to } 85^\circ\text{C}$		RECOMMENDED $T_A = -40^\circ\text{C to } 125^\circ\text{C}$		UNIT
				TYP	MAX	MIN	MAX	MIN	MAX	
t_{PLH}	A or B	Y	$C_L = 15\text{ pF}$	5.5	8.6	1	10	1	11	ns
t_{PHL}				5.5	8.6	1	10	1	11	ns
t_{PLH}	A or B	Y	$C_L = 50\text{ pF}$	7	10.6	1	12	1	11	ns
t_{PHL}				7	10.6	1	12	1	11	ns

5.8 Operating Characteristics

$V_{CC} = 5\text{ V}$, $T_A = 25^\circ\text{C}$

PARAMETER	TEST CONDITIONS	TYP	UNIT
C_{pd} Power dissipation capacitance	No load, $f = 1\text{ MHz}$	9	pF

5.9 Typical Characteristics

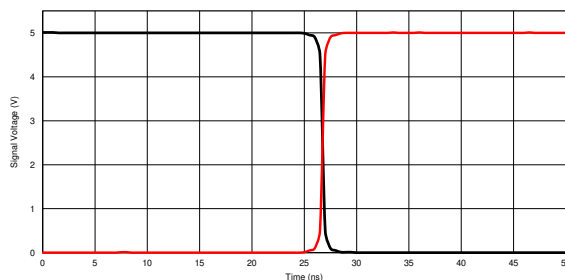

$T_A = 25^\circ\text{C}$, $V_A = 5\text{ V}$

Figure 5-1. Response Time vs Output Voltage

6 Parameter Measurement Information

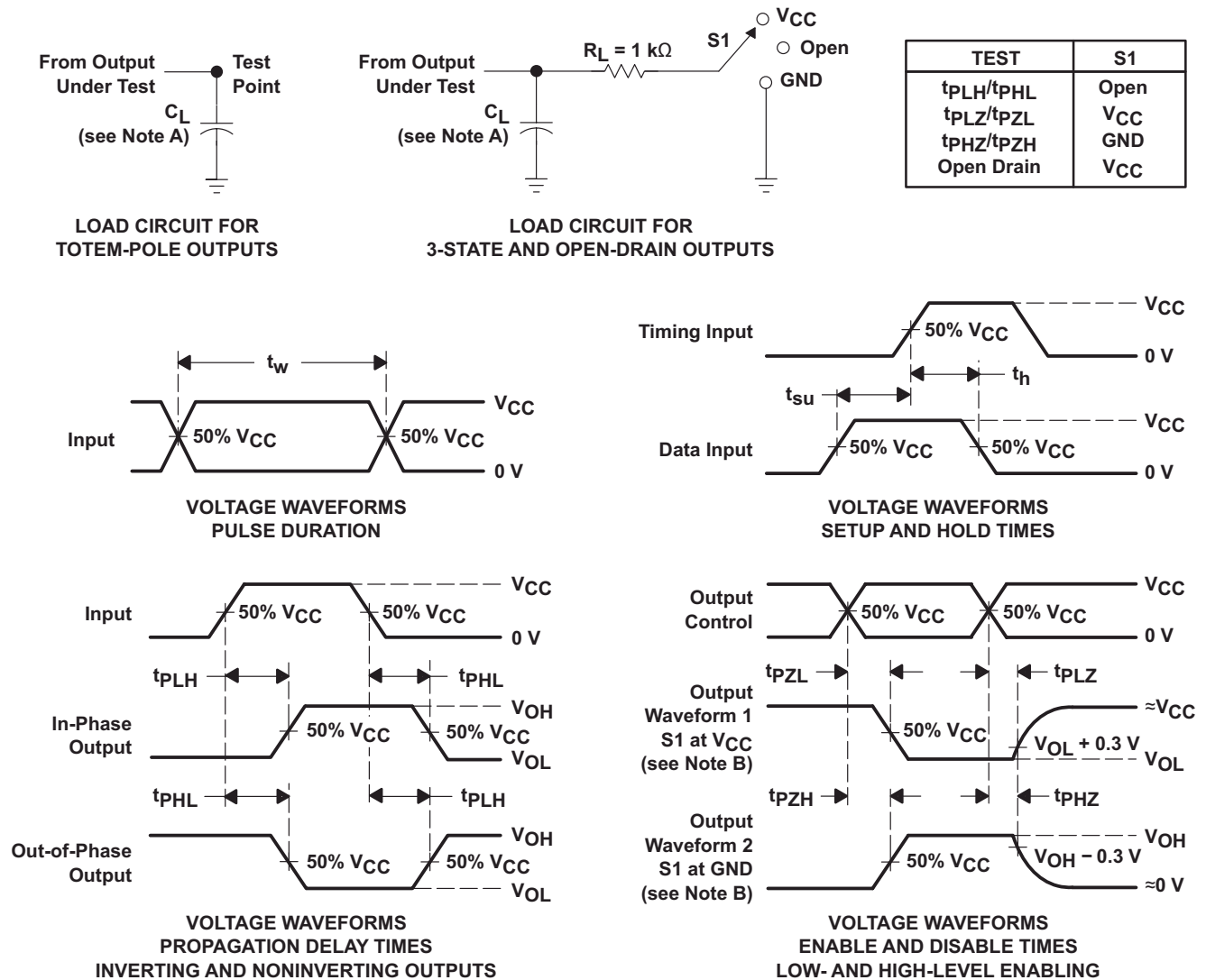

- A. C_L includes probe and jig capacitance.
- B. Waveform 1 is for an output with internal conditions such that the output is low except when disabled by the output control. Waveform 2 is for an output with internal conditions such that the output is high except when disabled by the output control.
- C. All input pulses are supplied by generators having the following characteristics: $PRR \leq 1\text{ MHz}$, $Z_O = 50\ \Omega$, $t_r \leq 3\text{ ns}$, $t_f \leq 3\text{ ns}$.
- D. The outputs are measured one at a time with one input transition per measurement.
- E. All parameters and waveforms are not applicable to all devices.

Figure 6-1. Load Circuit and Voltage Waveforms

7 Detailed Description

7.1 Overview

The SN74AHC1G14 device is a single inverter gate. The device performs the Boolean function $Y = \bar{A}$.

The device functions as an independent inverter gate, but because of the Schmitt action, gates may have different input threshold levels for positive- (V_{T+}) and negative-going (V_{T-}) signals.

7.2 Functional Block Diagram



Figure 7-1. Logic Diagram (Positive Side)

7.3 Feature Description

The SN74AHC1G14 device has a wide operating V_{CC} range of 2 V to 5.5 V, which allows it to be used in a broad range of systems. The low propagation delay allows fast switching and higher speeds of operation. In addition, the low-power consumption makes this device a good choice for portable and battery power-sensitive applications.

7.4 Device Functional Modes

Table 7-1 lists the functional modes for SN74AHC1G14.

Table 7-1. Function Table

INPUT ⁽¹⁾ A	OUTPUT ⁽²⁾ Y
H	L
L	H

- (1) H = High Voltage Level, L = Low Voltage Level, X = Don't Care
- (2) H = Driving High, L = Driving Low, Z = High Impedance State

8 Application and Implementation

Note

Information in the following applications sections is not part of the TI component specification, and TI does not warrant its accuracy or completeness. TI's customers are responsible for determining suitability of components for their purposes, as well as validating and testing their design implementation to confirm system functionality.

8.1 Application Information

Physically interactive interface elements like push buttons or rotary knobs offer simple and easy ways to interact with an electronic system. Many of these physical interface elements often have issues with bouncing, or where the physical conductive contact can connect and disconnect multiple times during a button push or release. This bouncing can cause one or more faulty transient signals to be passed during this transitional period. These faulty signals can be observed in many common applications, for example, a television remote with bouncing error can adjust the TV channel multiple times despite the button being pushed only once. To mitigate these faulty signals, we can use a Schmitt-trigger, or a device with hysteresis, to remove these faulty signals. Hysteresis allows a device to *remember* its history, and in this case, the SN74AHC1G14 uses this memory to debounce the signal of the physical element, or filter the faulty transient signals and pass only the valid signal each time the element is used. In this example, we show a push-button signal passed through an SN74AHC1G14 that is debounced and inverted to the microprocessor for push detection.

8.2 Typical Application

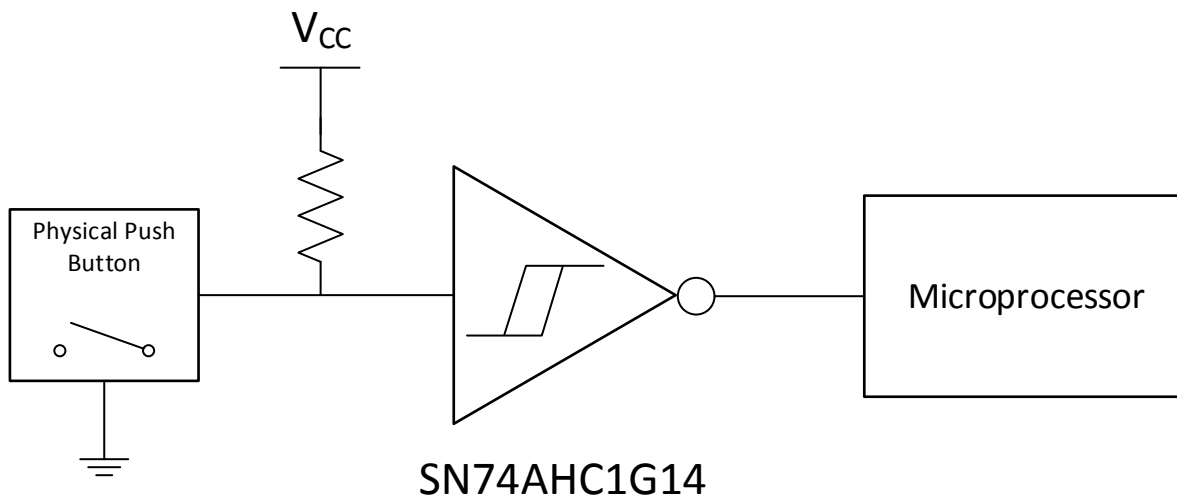

Figure 8-1. Switch Debouncer

8.2.1 Design Requirements

The SN74AHC1G14 device uses CMOS technology and has balanced output drive. Take care to avoid bus contention because it can drive currents that would exceed maximum limits. The SN74AHC1G14 allows for performing logical Boolean functions with hysteresis using digital signals. All input signals must remain as close as possible to either 0 V or VCC for optimal operation.

8.2.2 Detailed Design Procedure

- Recommended input conditions:
 - For rise time and fall time specifications, see $\Delta t/\Delta v$ in the [Section 5.3](#) table.
 - For specified high and low levels, see V_{IH} and V_{IL} in the [Section 5.3](#) table.
 - Inputs and outputs are overvoltage tolerant and can therefore go as high as 5.5 V at any valid V_{CC} .
- Recommended output conditions:
 - Load currents must not exceed ± 50 mA.
- Frequency selection criterion:
 - The effects of frequency upon the power consumption of the device can be studied in *CMOS Power Consumption and CPD Calculation*, [SCAA035](#).
 - Added trace resistance and capacitance can reduce maximum frequency capability; follow the layout practices listed in the [Section 8.4.1](#) section.

8.2.3 Application Curves

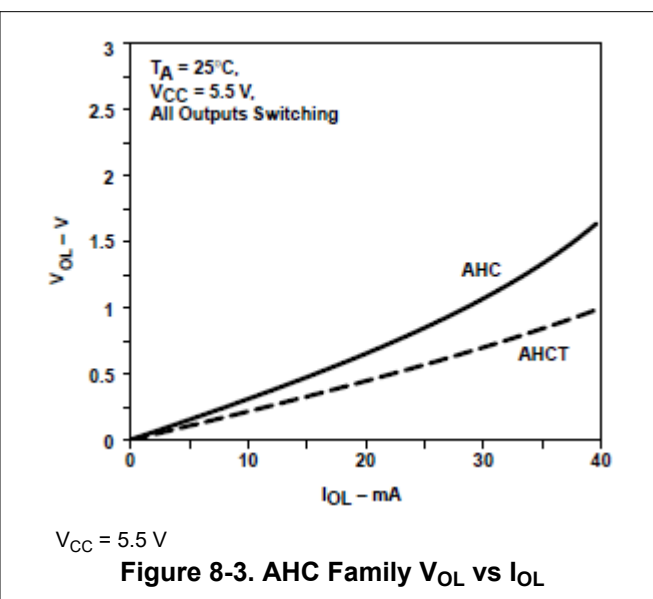
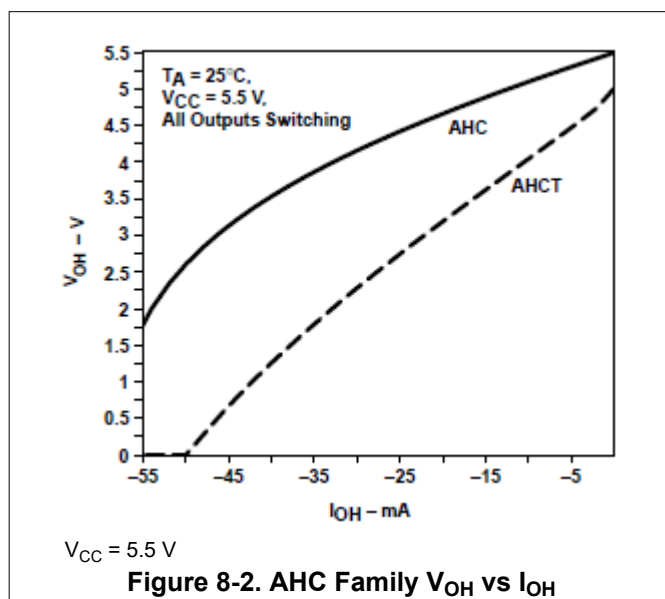

8.3 Power Supply Recommendations

The power supply can be any voltage between the minimum and maximum supply voltage rating listed in the [Section 5.3](#) table.

Each V_{CC} terminal must have a good bypass capacitor to prevent power disturbance. For devices with a single supply, a 0.1- μ F bypass capacitor is recommended. If multiple pins are labeled V_{CC} , then a 0.01- μ F or 0.022- μ F capacitor is recommended for each V_{CC} because the V_{CC} pins are tied together internally. For devices with dual-supply pins operating at different voltages, for example V_{CC} and V_{DD} , a 0.1- μ F bypass capacitor is recommended for each supply pin. To reject different frequencies of noise, use multiple bypass capacitors in parallel. Capacitors with values of 0.1 μ F and 1 μ F are commonly used in parallel. The bypass capacitor must be installed as close as possible to the power terminal for best results.

8.4 Layout

8.4.1 Layout Guidelines

Reflections and matching are closely related to the loop antenna theory but are different enough to be discussed separately from the theory. When a PCB trace turns a corner at a 90° angle, a reflection can occur. A reflection occurs primarily because of the change of width of the trace. At the apex of the turn, the trace width increases to 1.414 times the width. This increase upsets the transmission-line characteristics, especially the distributed capacitance and self-inductance of the trace, which results in the reflection. Not all PCB traces can be straight;

therefore some traces must turn corners. Figure 8-4 shows progressively better techniques of rounding corners. Only the last example (BEST) maintains constant trace width and minimizes reflections.

8.4.1.1 Layout Example

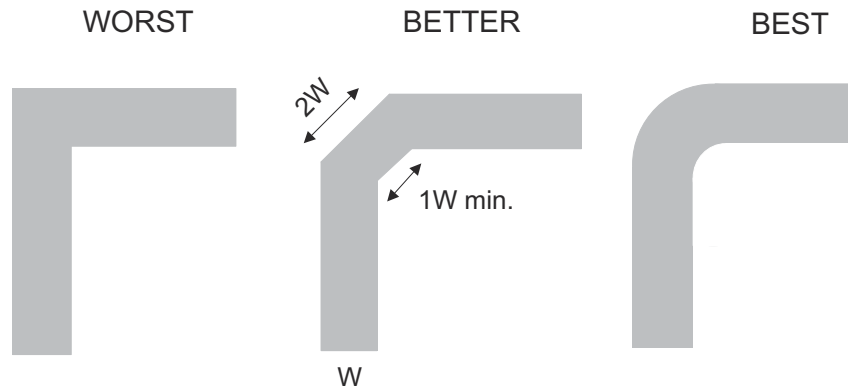

Figure 8-4. Trace Example

9 Device and Documentation Support

9.1 Documentation Support (Analog)

9.1.1 Related Documentation

For related documentation see the following:

- *Implications of Slow or Floating CMOS Inputs*, [SCBA004](#)
- *CMOS Power Consumption and CPD Calculation*, [SCAA035](#)
- *Selecting the Right Texas Instruments Signal Switch*, [SZZA030](#)

9.2 Support Resources

[TI E2E™ support forums](#) are an engineer's go-to source for fast, verified answers and design help — straight from the experts. Search existing answers or ask your own question to get the quick design help you need.

Linked content is provided "AS IS" by the respective contributors. They do not constitute TI specifications and do not necessarily reflect TI's views; see TI's [Terms of Use](#).

9.3 Trademarks

TI E2E™ is a trademark of Texas Instruments.

All trademarks are the property of their respective owners.

9.4 Electrostatic Discharge Caution



This integrated circuit can be damaged by ESD. Texas Instruments recommends that all integrated circuits be handled with appropriate precautions. Failure to observe proper handling and installation procedures can cause damage.

ESD damage can range from subtle performance degradation to complete device failure. Precision integrated circuits may be more susceptible to damage because very small parametric changes could cause the device not to meet its published specifications.

9.5 Glossary

[TI Glossary](#) This glossary lists and explains terms, acronyms, and definitions.

10 Revision History

NOTE: Page numbers for previous revisions may differ from page numbers in the current version.

Changes from Revision R (October 2023) to Revision S (February 2024) Page

- | | |
|--|---|
| • Updated thermal values for DBV package from R θ JA = 225.7 to 278, R θ JC(top) = 160.3 to 180.5, R θ JB = 59.4 to 184.4, Ψ JT = 41.0 to 115.4, Ψ JB = 58.7 to 183.4, R θ JC(bot) = N/A, all values in °C/W | 5 |
|--|---|

Changes from Revision Q (February 2014) to Revision R (October 2023) Page

- | | |
|---|---|
| • Updated the numbering format for tables, figures, and cross-references throughout the document..... | 1 |
| • Updated thermal values for DCK package: R θ JA = 287.6 to 289.2, all values in °C/W | 5 |
| • Added thermal values for DCK package: R θ JC(top) = 205.8, R θ JB = 176.2, Ψ JT = 117.6, Ψ JB = 175.1, R θ JC(bot) = N/A, all values in °C/W | 5 |

11 Mechanical, Packaging, and Orderable Information

The following pages include mechanical packaging and orderable information. This information is the most current data available for the designated devices. This data is subject to change without notice and revision of this document. For browser based versions of this data sheet, refer to the left hand navigation.

PACKAGING INFORMATION

Orderable Device	Status (1)	Package Type	Package Drawing	Pins	Package Qty	Eco Plan (2)	Lead finish/ Ball material (6)	MSL Peak Temp (3)	Op Temp (°C)	Device Marking (4/5)	Samples
SN74AHC1G14DBVR	ACTIVE	SOT-23	DBV	5	3000	RoHS & Green	NIPDAU SN	Level-1-260C-UNLIM	-40 to 125	(38SH, A143, A14G, A14J, A14L, A14S)	Samples
SN74AHC1G14DBVRE4	ACTIVE	SOT-23	DBV	5	3000	RoHS & Green	NIPDAU	Level-1-260C-UNLIM	-40 to 125	A14G	Samples
SN74AHC1G14DBVRG4	ACTIVE	SOT-23	DBV	5	3000	RoHS & Green	NIPDAU	Level-1-260C-UNLIM	-40 to 125	A14G	Samples
SN74AHC1G14DBVT	OBSOLETE	SOT-23	DBV	5		TBD	Call TI	Call TI	-40 to 125	(A143, A14G, A14J, A14S)	
SN74AHC1G14DCK3	ACTIVE	SC70	DCK	5	3000	RoHS & Non-Green	SNBI	Level-1-260C-UNLIM	-40 to 125	AFY	Samples
SN74AHC1G14DCKR	ACTIVE	SC70	DCK	5	3000	RoHS & Green	NIPDAU SN	Level-1-260C-UNLIM	-40 to 125	(1R9, AF3, AFG, AFJ, AFL, AFS)	Samples
SN74AHC1G14DCKRG4	ACTIVE	SC70	DCK	5	3000	RoHS & Green	NIPDAU	Level-1-260C-UNLIM	-40 to 125	AF3	Samples
SN74AHC1G14DCKT	OBSOLETE	SC70	DCK	5		TBD	Call TI	Call TI	-40 to 125	(AF3, AFG, AFJ, AFS)	
SN74AHC1G14DCKTE4	ACTIVE	SC70	DCK	5	250	RoHS & Green	NIPDAU	Level-1-260C-UNLIM	-40 to 125	AF3	Samples
SN74AHC1G14DCKTG4	ACTIVE	SC70	DCK	5	250	RoHS & Green	NIPDAU	Level-1-260C-UNLIM	-40 to 125	AF3	Samples
SN74AHC1G14DRLR	ACTIVE	SOT-5X3	DRL	5	4000	RoHS & Green	NIPDAUAG	Level-1-260C-UNLIM	-40 to 125	AFS	Samples
SN74AHC1G14DRLRG4	ACTIVE	SOT-5X3	DRL	5	4000	RoHS & Green	NIPDAUAG	Level-1-260C-UNLIM	-40 to 125	AFS	Samples

(1) The marketing status values are defined as follows:

ACTIVE: Product device recommended for new designs.

LIFEBUY: TI has announced that the device will be discontinued, and a lifetime-buy period is in effect.

NRND: Not recommended for new designs. Device is in production to support existing customers, but TI does not recommend using this part in a new design.

PREVIEW: Device has been announced but is not in production. Samples may or may not be available.

OBSOLETE: TI has discontinued the production of the device.

(2) **RoHS:** TI defines "RoHS" to mean semiconductor products that are compliant with the current EU RoHS requirements for all 10 RoHS substances, including the requirement that RoHS substance do not exceed 0.1% by weight in homogeneous materials. Where designed to be soldered at high temperatures, "RoHS" products are suitable for use in specified lead-free processes. TI may reference these types of products as "Pb-Free".

RoHS Exempt: TI defines "RoHS Exempt" to mean products that contain lead but are compliant with EU RoHS pursuant to a specific EU RoHS exemption.

Green: TI defines "Green" to mean the content of Chlorine (Cl) and Bromine (Br) based flame retardants meet JS709B low halogen requirements of ≤ 1000 ppm threshold. Antimony trioxide based flame retardants must also meet the ≤ 1000 ppm threshold requirement.

- (3) MSL, Peak Temp. - The Moisture Sensitivity Level rating according to the JEDEC industry standard classifications, and peak solder temperature.
- (4) There may be additional marking, which relates to the logo, the lot trace code information, or the environmental category on the device.
- (5) Multiple Device Markings will be inside parentheses. Only one Device Marking contained in parentheses and separated by a "~" will appear on a device. If a line is indented then it is a continuation of the previous line and the two combined represent the entire Device Marking for that device.
- (6) Lead finish/Ball material - Orderable Devices may have multiple material finish options. Finish options are separated by a vertical ruled line. Lead finish/Ball material values may wrap to two lines if the finish value exceeds the maximum column width.

Important Information and Disclaimer: The information provided on this page represents TI's knowledge and belief as of the date that it is provided. TI bases its knowledge and belief on information provided by third parties, and makes no representation or warranty as to the accuracy of such information. Efforts are underway to better integrate information from third parties. TI has taken and continues to take reasonable steps to provide representative and accurate information but may not have conducted destructive testing or chemical analysis on incoming materials and chemicals. TI and TI suppliers consider certain information to be proprietary, and thus CAS numbers and other limited information may not be available for release.

In no event shall TI's liability arising out of such information exceed the total purchase price of the TI part(s) at issue in this document sold by TI to Customer on an annual basis.

OTHER QUALIFIED VERSIONS OF SN74AHC1G14 :

- Automotive : [SN74AHC1G14-Q1](#)

NOTE: Qualified Version Definitions:

- Automotive - Q100 devices qualified for high-reliability automotive applications targeting zero defects

TAPE AND REEL INFORMATION

QUADRANT ASSIGNMENTS FOR PIN 1 ORIENTATION IN TAPE

*All dimensions are nominal

Device	Package Type	Package Drawing	Pins	SPQ	Reel Diameter (mm)	Reel Width W1 (mm)	A0 (mm)	B0 (mm)	K0 (mm)	P1 (mm)	W (mm)	Pin1 Quadrant
SN74AHC1G14DBVR	SOT-23	DBV	5	3000	178.0	9.0	3.3	3.2	1.4	4.0	8.0	Q3
SN74AHC1G14DBVR	SOT-23	DBV	5	3000	180.0	8.4	3.23	3.17	1.37	4.0	8.0	Q3
SN74AHC1G14DBVRG4	SOT-23	DBV	5	3000	178.0	9.0	3.23	3.17	1.37	4.0	8.0	Q3
SN74AHC1G14DCKR	SC70	DCK	5	3000	178.0	9.0	2.4	2.5	1.2	4.0	8.0	Q3
SN74AHC1G14DCKR	SC70	DCK	5	3000	180.0	8.4	2.47	2.3	1.25	4.0	8.0	Q3
SN74AHC1G14DCKRG4	SC70	DCK	5	3000	178.0	9.2	2.4	2.4	1.22	4.0	8.0	Q3
SN74AHC1G14DCKTG4	SC70	DCK	5	250	178.0	9.2	2.4	2.4	1.22	4.0	8.0	Q3
SN74AHC1G14DRLR	SOT-5X3	DRL	5	4000	180.0	8.4	1.98	1.78	0.69	4.0	8.0	Q3

TAPE AND REEL BOX DIMENSIONS



*All dimensions are nominal

Device	Package Type	Package Drawing	Pins	SPQ	Length (mm)	Width (mm)	Height (mm)
SN74AHC1G14DBVR	SOT-23	DBV	5	3000	180.0	180.0	18.0
SN74AHC1G14DBVR	SOT-23	DBV	5	3000	202.0	201.0	28.0
SN74AHC1G14DBVRG4	SOT-23	DBV	5	3000	180.0	180.0	18.0
SN74AHC1G14DCKR	SC70	DCK	5	3000	180.0	180.0	18.0
SN74AHC1G14DCKR	SC70	DCK	5	3000	202.0	201.0	28.0
SN74AHC1G14DCKRG4	SC70	DCK	5	3000	180.0	180.0	18.0
SN74AHC1G14DCKTG4	SC70	DCK	5	250	180.0	180.0	18.0
SN74AHC1G14DRLR	SOT-5X3	DRL	5	4000	202.0	201.0	28.0

EXAMPLE BOARD LAYOUT

DBV0005A

SOT-23 - 1.45 mm max height

SMALL OUTLINE TRANSISTOR

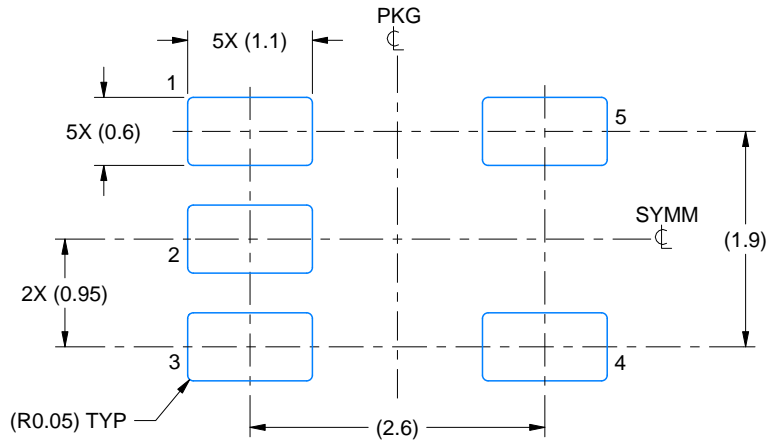

LAND PATTERN EXAMPLE
EXPOSED METAL SHOWN
SCALE:15X

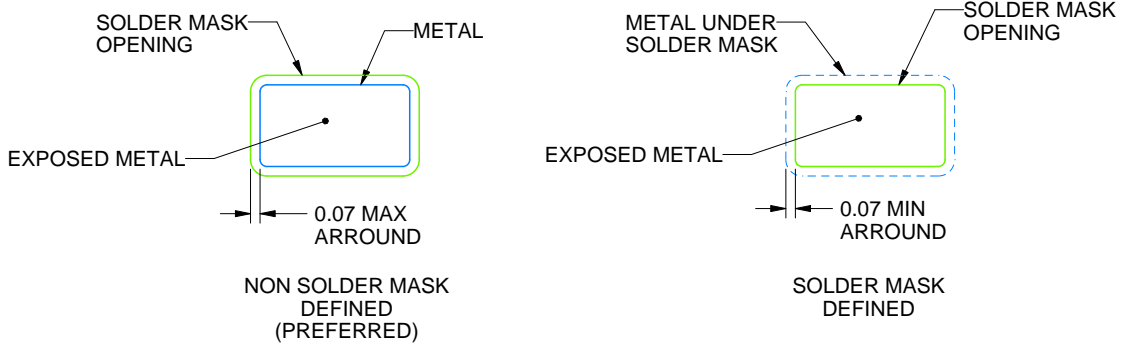

SOLDER MASK DETAILS

4214839/K 08/2024

NOTES: (continued)

- 6. Publication IPC-7351 may have alternate designs.
- 7. Solder mask tolerances between and around signal pads can vary based on board fabrication site.

EXAMPLE STENCIL DESIGN

DBV0005A

SOT-23 - 1.45 mm max height

SMALL OUTLINE TRANSISTOR

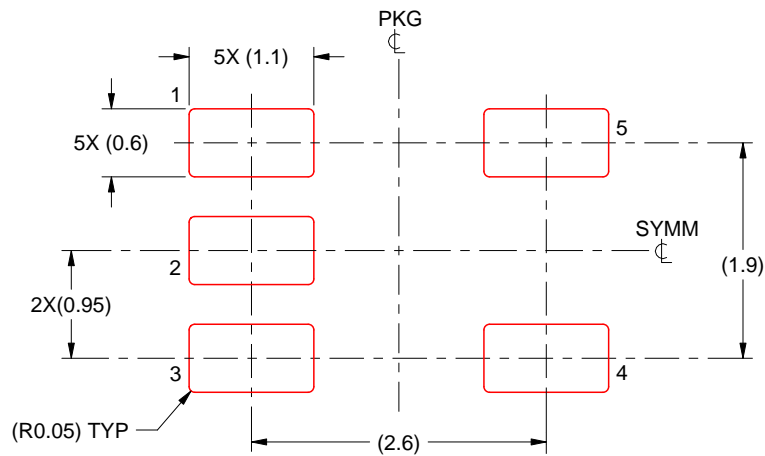

SOLDER PASTE EXAMPLE
BASED ON 0.125 mm THICK STENCIL
SCALE:15X

4214839/K 08/2024

NOTES: (continued)

8. Laser cutting apertures with trapezoidal walls and rounded corners may offer better paste release. IPC-7525 may have alternate design recommendations.
9. Board assembly site may have different recommendations for stencil design.

EXAMPLE BOARD LAYOUT

DRL0005A

SOT - 0.6 mm max height

PLASTIC SMALL OUTLINE

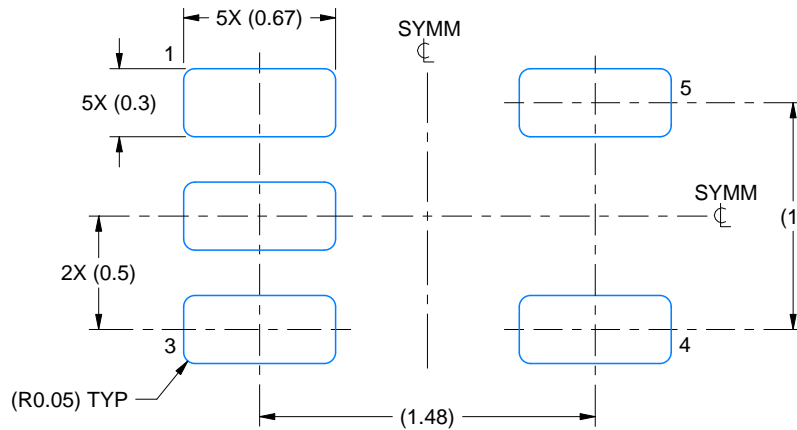

LAND PATTERN EXAMPLE
SCALE:30X

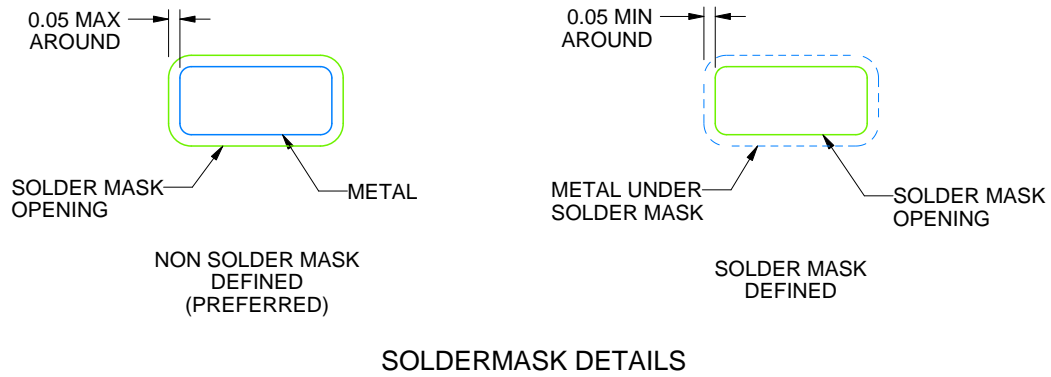

SOLDERMASK DETAILS

4220753/D 07/2024

NOTES: (continued)

- 5. Publication IPC-7351 may have alternate designs.
- 6. Solder mask tolerances between and around signal pads can vary based on board fabrication site.

EXAMPLE STENCIL DESIGN

DRL0005A

SOT - 0.6 mm max height

PLASTIC SMALL OUTLINE

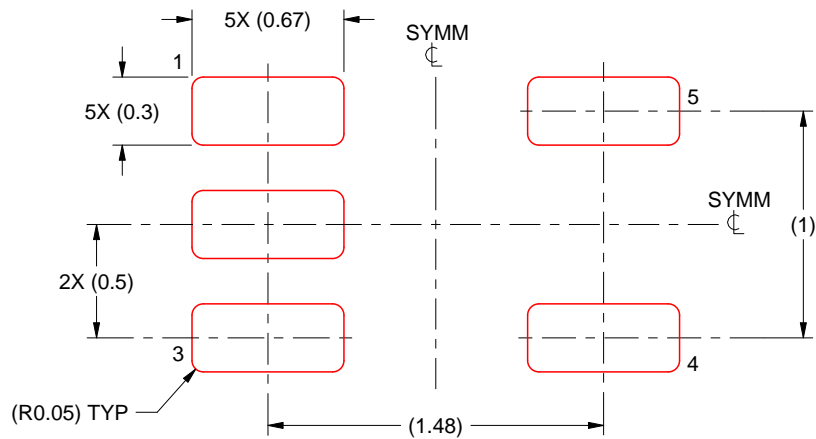

SOLDER PASTE EXAMPLE
BASED ON 0.1 mm THICK STENCIL
SCALE:30X

4220753/D 07/2024

NOTES: (continued)

7. Laser cutting apertures with trapezoidal walls and rounded corners may offer better paste release. IPC-7525 may have alternate design recommendations.
8. Board assembly site may have different recommendations for stencil design.

DCK0005A



PACKAGE OUTLINE

SOT - 1.1 max height

SMALL OUTLINE TRANSISTOR

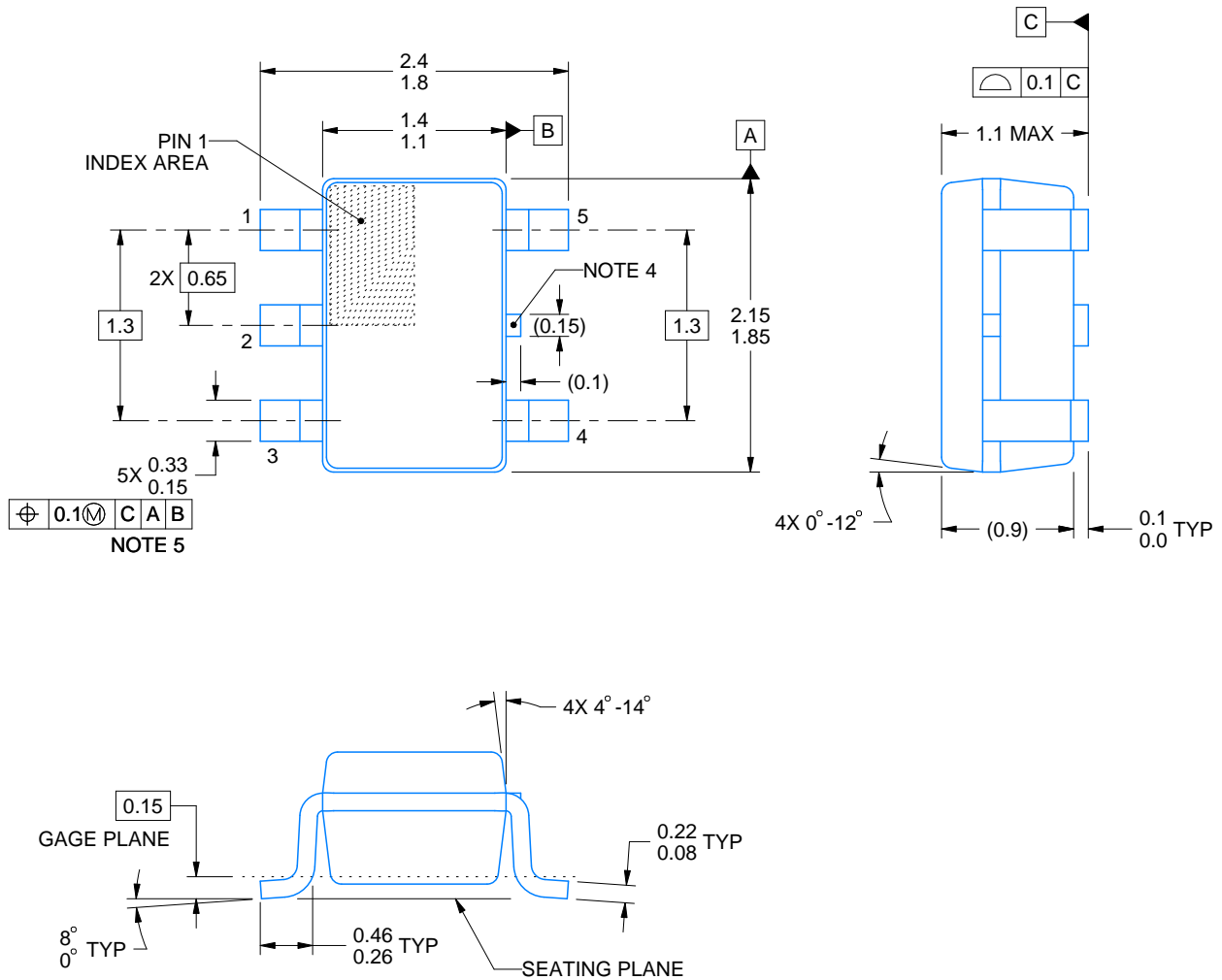

4214834/F 08/2024

NOTES:

1. All linear dimensions are in millimeters. Any dimensions in parenthesis are for reference only. Dimensioning and tolerancing per ASME Y14.5M.
2. This drawing is subject to change without notice.
3. Reference JEDEC MO-203.
4. Support pin may differ or may not be present.
5. Lead width does not comply with JEDEC.
6. Body dimensions do not include mold flash, protrusions, or gate burrs. Mold flash, protrusions, or gate burrs shall not exceed 0.25mm per side

EXAMPLE BOARD LAYOUT

DCK0005A

SOT - 1.1 max height

SMALL OUTLINE TRANSISTOR

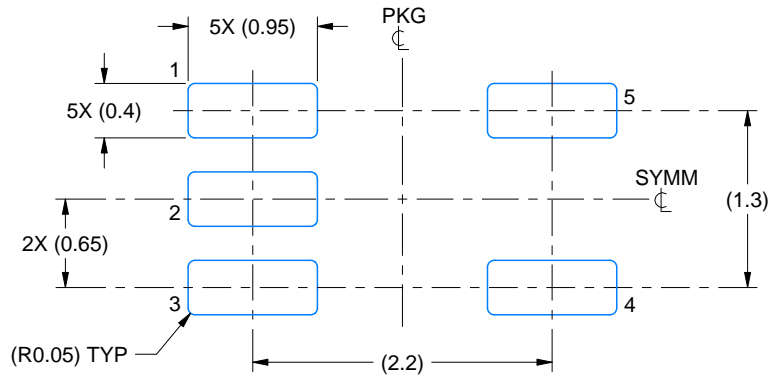

LAND PATTERN EXAMPLE
EXPOSED METAL SHOWN
SCALE:18X

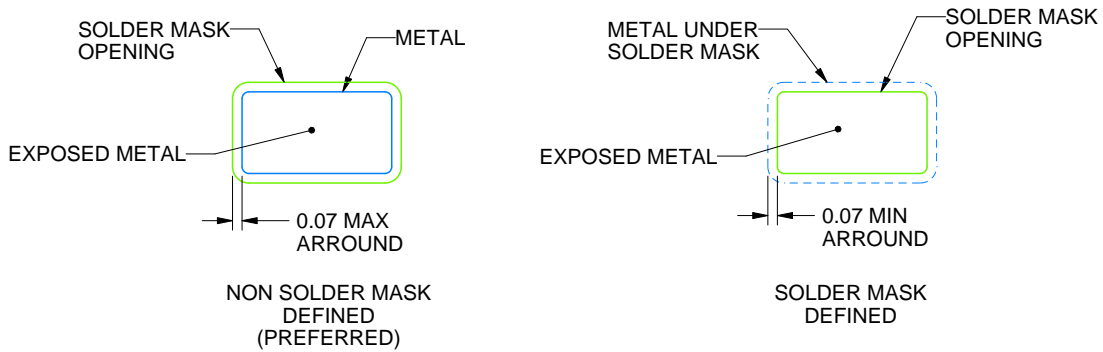

SOLDER MASK DETAILS

4214834/F 08/2024

NOTES: (continued)

- 7. Publication IPC-7351 may have alternate designs.
- 8. Solder mask tolerances between and around signal pads can vary based on board fabrication site.

EXAMPLE STENCIL DESIGN

DCK0005A

SOT - 1.1 max height

SMALL OUTLINE TRANSISTOR

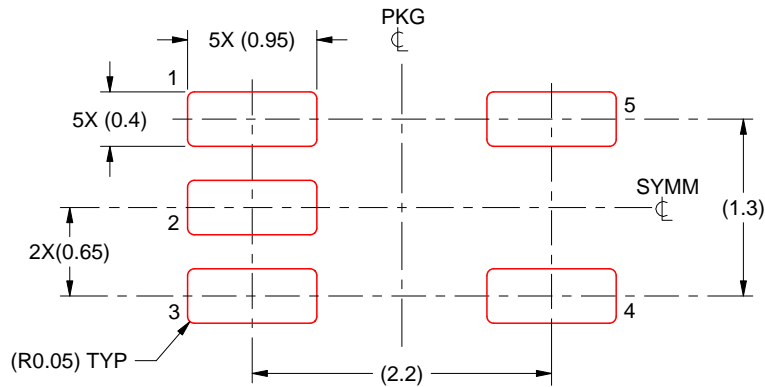

SOLDER PASTE EXAMPLE
BASED ON 0.125 THICK STENCIL
SCALE: 18X

4214834/F 08/2024

NOTES: (continued)

9. Laser cutting apertures with trapezoidal walls and rounded corners may offer better paste release. IPC-7525 may have alternate design recommendations.
10. Board assembly site may have different recommendations for stencil design.

IMPORTANT NOTICE AND DISCLAIMER

TI PROVIDES TECHNICAL AND RELIABILITY DATA (INCLUDING DATA SHEETS), DESIGN RESOURCES (INCLUDING REFERENCE DESIGNS), APPLICATION OR OTHER DESIGN ADVICE, WEB TOOLS, SAFETY INFORMATION, AND OTHER RESOURCES "AS IS" AND WITH ALL FAULTS, AND DISCLAIMS ALL WARRANTIES, EXPRESS AND IMPLIED, INCLUDING WITHOUT LIMITATION ANY IMPLIED WARRANTIES OF MERCHANTABILITY, FITNESS FOR A PARTICULAR PURPOSE OR NON-INFRINGEMENT OF THIRD PARTY INTELLECTUAL PROPERTY RIGHTS.

These resources are intended for skilled developers designing with TI products. You are solely responsible for (1) selecting the appropriate TI products for your application, (2) designing, validating and testing your application, and (3) ensuring your application meets applicable standards, and any other safety, security, regulatory or other requirements.

These resources are subject to change without notice. TI grants you permission to use these resources only for development of an application that uses the TI products described in the resource. Other reproduction and display of these resources is prohibited. No license is granted to any other TI intellectual property right or to any third party intellectual property right. TI disclaims responsibility for, and you will fully indemnify TI and its representatives against, any claims, damages, costs, losses, and liabilities arising out of your use of these resources.

TI's products are provided subject to [TI's Terms of Sale](#) or other applicable terms available either on [ti.com](https://www.ti.com) or provided in conjunction with such TI products. TI's provision of these resources does not expand or otherwise alter TI's applicable warranties or warranty disclaimers for TI products.

TI objects to and rejects any additional or different terms you may have proposed.

Mailing Address: Texas Instruments, Post Office Box 655303, Dallas, Texas 75265
Copyright © 2024, Texas Instruments Incorporated