

## SN74AUC1G126 Single Bus Buffer Gate With Tri-state Output

### 1 Features

- Latch-Up Performance Exceeds 100 mA Per JESD 78, Class II
- ESD Protection Exceeds JESD22
  - 2000-V Human-Body Model (A114-A)
  - 200-V Machine Model (A115-A)
  - 1000-V Charged-Device Model (C101)
- Available in TI's NanoFree™ Package
- Optimized for 1.8-V Operation and is 3.6-V I/O Tolerant to Support Mixed-Mode Signal Operation
- $I_{off}$  Supports Partial Power Down Mode and Back Drive Protection
- Sub-1 V Operable
- Maximum  $t_{pd}$  of 2.5 ns at 1.8 V
- Low Power Consumption, 10- $\mu$ A Maximum  $I_{CC}$
- $\pm 8$ -mA Output Drive at 1.8 V

### 2 Applications

- AV Receiver
- Audio Dock: Portable
- Blu-ray™ Player and Home Theater
- Embedded PC
- MP3 Player/Recorder (Portable Audio)
- Personal Digital Assistant (PDA)
- Power: AC/DC Supply, Single Controller
- Solid State Drive (SSD): Client and Enterprise
- TV: LCD, Digital, and High-Definition (HD)
- Tablet: Enterprise
- Video Analytics: Server
- Wireless Headset, Keyboard, and Mouse

### 3 Description

The SN74AUC1G126 bus buffer gate is operational at 0.8-V to 2.7-V  $V_{CC}$ , but is designed specifically for 1.65-V to 1.95-V  $V_{CC}$  operation.

The SN74AUC1G126 device is a single line driver with a tri-state output. The output is disabled when the output-enable (OE) input is low.

To ensure the high-impedance state during power up or power down, OE should be tied to GND through a pulldown resistor; the minimum value of the resistor is determined by the current-sourcing capability of the driver.

NanoFree™ package technology is a major breakthrough in device packaging concepts, using the die as the package.

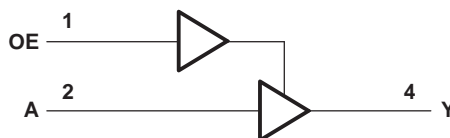
This device is fully specified for partial-power-down applications using  $I_{off}$ . The  $I_{off}$  circuitry disables the outputs, which prevents damaging current backflow through the device when it is powered down.

#### Device Information<sup>(1)</sup>

PART NUMBER	PACKAGE	BODY SIZE (NOM)
SN74AUC1G126DBV	SOT-23 (5)	2.90 mm x 1.60 mm
SN74AUC1G126DCK	SC70 (5)	2.00 mm x 1.25 mm
SN74AUC1G126YZP	DSBGA (5)	1.388 mm x 0.888 mm

(1) For all available packages, see the orderable addendum at the end of the data sheet.

#### Logic Diagram (Positive Logic)



## Table of Contents

<b>1 Features</b> .....	<b>1</b>	9.2 Functional Block Diagram .....	<b>12</b>
<b>2 Applications</b> .....	<b>1</b>	9.3 Feature Description .....	<b>12</b>
<b>3 Description</b> .....	<b>1</b>	9.4 Device Functional Modes .....	<b>13</b>
<b>4 Revision History</b> .....	<b>2</b>	<b>10 Application and Implementation</b> .....	<b>14</b>
<b>5 Pin Configuration and Functions</b> .....	<b>3</b>	10.1 Application Information .....	<b>14</b>
<b>6 Specifications</b> .....	<b>4</b>	10.2 Typical Application .....	<b>14</b>
6.1 Absolute Maximum Ratings .....	<b>4</b>	<b>11 Power Supply Recommendations</b> .....	<b>15</b>
6.2 ESD Ratings .....	<b>4</b>	<b>12 Layout</b> .....	<b>16</b>
6.3 Recommended Operating Conditions .....	<b>5</b>	12.1 Layout Guidelines .....	<b>16</b>
6.4 Thermal Information .....	<b>5</b>	12.2 Layout Example .....	<b>16</b>
6.5 Electrical Characteristics .....	<b>6</b>	<b>13 Device and Documentation Support</b> .....	<b>17</b>
6.6 Switching Characteristics: $C_L = 15$ pF .....	<b>7</b>	13.1 Documentation Support .....	<b>17</b>
6.7 Switching Characteristics: $C_L = 30$ pF .....	<b>7</b>	13.2 Receiving Notification of Documentation Updates .....	<b>17</b>
6.8 Operating Characteristics .....	<b>7</b>	13.3 Community Resources .....	<b>17</b>
<b>7 Typical Characteristics</b> .....	<b>8</b>	13.4 Trademarks .....	<b>17</b>
<b>8 Parameter Measurement Information</b> .....	<b>10</b>	13.5 Electrostatic Discharge Caution .....	<b>17</b>
<b>9 Detailed Description</b> .....	<b>12</b>	13.6 Glossary .....	<b>17</b>
9.1 Overview .....	<b>12</b>	<b>14 Mechanical, Packaging, and Orderable Information</b> .....	<b>17</b>

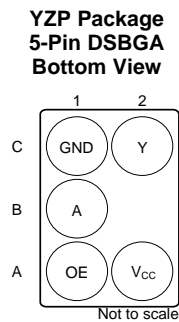
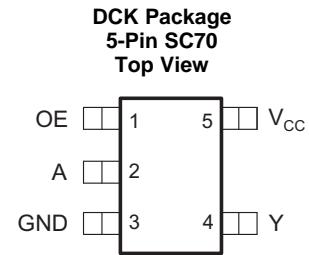
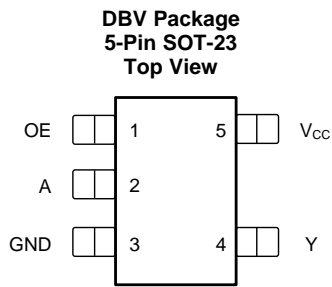
## 4 Revision History

NOTE: Page numbers for previous revisions may differ from page numbers in the current version.

<b>Changes from Revision K (June 2017) to Revision L</b>	<b>Page</b>
• Updated body size of YZP package. ....	<b>1</b>
• Added junction temperature to <i>Absolute Maximum Ratings</i> .....	<b>4</b>
• Add <i>Detailed Description</i> , <i>Application and Implementation</i> , <i>Power Supply Recommendations</i> , and <i>Layout</i> sections .....	<b>12</b>

<b>Changes from Revision J (July 2007) to Revision K</b>	<b>Page</b>
• Deleted DRY package throughout data sheet .....	<b>1</b>
• Added <i>Applications</i> , <i>Device Information</i> table, <i>ESD Ratings</i> table, <i>Thermal Information</i> table, <i>Feature Description</i> section, <i>Device Functional Modes</i> , <i>Device and Documentation Support</i> section, and <i>Mechanical, Packaging, and Orderable Information</i> section .....	<b>1</b>
• Deleted <i>Ordering Information</i> table, see <i>Mechanical, Packaging, and Orderable Information</i> at the end of the data sheet .....	<b>1</b>

## 5 Pin Configuration and Functions



### Pin Functions

NAME	PIN		I/O	DESCRIPTION
	DBV, DCK	YZP		
A	2	B1	I	Logic input
GND	3	C1	—	Ground
OE	1	A1	I	Output enable
V <sub>CC</sub>	5	A2	—	Positive supply
Y	4	C2	O	Output

## 6 Specifications

### 6.1 Absolute Maximum Ratings

over operating free-air temperature range (unless otherwise noted)<sup>(1)</sup>

		MIN	MAX	UNIT
Supply voltage, $V_{CC}$		-0.5	3.6	V
Input voltage, $V_I$ <sup>(2)</sup>		-0.5	3.6	V
Voltage applied to any output in the high-impedance or power-off state, $V_O$ <sup>(2)</sup>		-0.5	3.6	V
Output voltage, $V_O$ <sup>(2)</sup>		-0.5	$V_{CC} + 0.5$	V
Input clamp current, $I_{IK}$	$V_I < 0$		-50	mA
Output clamp current, $I_{OK}$	$V_O < 0$		-50	mA
Continuous output current, $I_O$			±20	mA
Continuous current through $V_{CC}$ or GND			±100	mA
Junction temperature, $T_J$			150	°C
Storage temperature, $T_{stg}$		-65	150	°C

- (1) Stresses beyond those listed under *Absolute Maximum Ratings* may cause permanent damage to the device. These are stress ratings only, and functional operation of the device at these or any other conditions beyond those indicated under "*Recommended Operating Conditions*" is not implied. Exposure to absolute-maximum-rated conditions for extended periods may affect device reliability.
- (2) The input negative-voltage and output voltage ratings may be exceeded if the input and output current ratings are observed.

### 6.2 ESD Ratings

		VALUE	UNIT
$V_{(ESD)}$ Electrostatic discharge	Human-body model (HBM), per ANSI/ESDA/JEDEC JS-001 <sup>(1)</sup>	±2000	V
	Charged-device model (CDM), per JEDEC specification JESD22-C101 <sup>(2)</sup>	±1000	
	Machine Model (A115-A)	±200	

- (1) JEDEC document JEP155 states that 500-V HBM allows safe manufacturing with a standard ESD control process.
- (2) JEDEC document JEP157 states that 250-V CDM allows safe manufacturing with a standard ESD control process.

### 6.3 Recommended Operating Conditions

 over operating free-air temperature range (unless otherwise noted)<sup>(1)</sup>

		MIN	MAX	UNIT
V <sub>CC</sub>	Supply voltage	0.8	2.7	V
V <sub>IH</sub>	High-level input voltage	V <sub>CC</sub> = 0.8 V	V <sub>CC</sub>	V
		V <sub>CC</sub> = 1.1 V to 1.95 V	0.65 × V <sub>CC</sub>	
		V <sub>CC</sub> = 2.3 V to 2.7 V	1.7	
V <sub>IL</sub>	Low-level input voltage	V <sub>CC</sub> = 0.8 V	0	V
		V <sub>CC</sub> = 1.1 V to 1.95 V	0.35 × V <sub>CC</sub>	
		V <sub>CC</sub> = 2.3 V to 2.7 V	0.7	
V <sub>I</sub>	Input voltage	0	3.6	V
V <sub>O</sub>	Output voltage	0	V <sub>CC</sub>	V
I <sub>OH</sub>	High-level output current	V <sub>CC</sub> = 0.8 V	−0.7	mA
		V <sub>CC</sub> = 1.1 V	−3	
		V <sub>CC</sub> = 1.4 V	−5	
		V <sub>CC</sub> = 1.65 V	−8	
		V <sub>CC</sub> = 2.3 V	−9	
I <sub>OL</sub>	Low-level output current	V <sub>CC</sub> = 0.8 V	0.7	mA
		V <sub>CC</sub> = 1.1 V	3	
		V <sub>CC</sub> = 1.4 V	5	
		V <sub>CC</sub> = 1.65 V	8	
		V <sub>CC</sub> = 2.3 V	9	
Δt/Δv	Input transition rise or fall rate	V <sub>CC</sub> = 0.8 V to 1.6 V	20	ns/V
		V <sub>CC</sub> = 1.65 V to 1.95 V	10	
		V <sub>CC</sub> = 2.3 V to 2.7 V	3	
T <sub>A</sub>	Operating free-air temperature	−40	85	°C

(1) All unused inputs of the device must be held at V<sub>CC</sub> or GND to ensure proper device operation. See [Implications of Slow or Floating CMOS Inputs application report](#).

### 6.4 Thermal Information

THERMAL METRIC <sup>(1)</sup>	SN74AUC1G126			UNIT	
	DBV (SOT-23)	DCK (SC70)	YZP (DSBGA)		
	5 PINS	5 PINS	5 PINS		
R <sub>θJA</sub>	Junction-to-ambient thermal resistance	206	252	132	°C/W

(1) For more information about traditional and new thermal metrics, see the [Semiconductor and IC Package Thermal Metrics](#) application report.

## 6.5 Electrical Characteristics

over recommended operating free-air temperature range (unless otherwise noted)

PARAMETER	TEST CONDITIONS	MIN	TYP <sup>(1)</sup>	MAX	UNIT
$V_{OH}$ High-level output voltage	$I_{OH} = -100 \mu A$ , $V_{CC} = 0.8 V$ to $2.7 V$	$V_{CC} - 0.1$			V
	$I_{OH} = -0.7 mA$ , $V_{CC} = 0.8 V$		0.55		
	$I_{OH} = -3 mA$ , $V_{CC} = 1.1 V$	0.8			
	$I_{OH} = -5 mA$ , $V_{CC} = 1.4 V$	1			
	$I_{OH} = -8 mA$ , $V_{CC} = 1.65 V$	1.2			
	$I_{OH} = -9 mA$ , $V_{CC} = 2.3 V$	1.8			
$V_{OL}$ Low-level output voltage	$I_{OL} = 100 \mu A$ , $V_{CC} = 0.8 V$ to $2.7 V$			0.2	V
	$I_{OL} = 0.7 mA$ , $V_{CC} = 0.8 V$		0.25		
	$I_{OL} = 3 mA$ , $V_{CC} = 1.1 V$			0.3	
	$I_{OL} = 5 mA$ , $V_{CC} = 1.4 V$			0.4	
	$I_{OL} = 8 mA$ , $V_{CC} = 1.65 V$			0.45	
	$I_{OL} = 9 mA$ , $V_{CC} = 2.3 V$			0.6	
$I_I$ Inflection-point current	A or OE input: $V_I = V_{CC}$ or GND, $V_{CC} = 0$ to $2.7 V$			$\pm 5$	$\mu A$
$I_{off}$ Off-state current	$V_I$ or $V_O = 2.7 V$ , $V_{CC} = 0$			$\pm 10$	$\mu A$
$I_{OZ}$ High-impedance-state output current	$V_O = V_{CC}$ or GND, $V_{CC} = 2.7 V$			$\pm 10$	$\mu A$
$I_{CC}$ Supply current	$V_I = V_{CC}$ or GND, $V_{CC} = 0.8 V$ to $2.7 V$ $I_O = 0$			10	$\mu A$
$C_i$ Input capacitance	$V_I = V_{CC}$ or GND, $V_{CC} = 2.5 V$		2.5		pF
$C_o$ Output capacitance	$V_O = V_{CC}$ or GND, $V_{CC} = 2.5 V$		5.5		pF

 (1) All typical values are at  $T_A = 25^\circ C$ .

## 6.6 Switching Characteristics: $C_L = 15 \text{ pF}$

over recommended operating free-air temperature range,  $C_L = 15 \text{ pF}$  (unless otherwise noted) (see [Table 2](#))

PARAMETER	TEST CONDITIONS		MIN	TYP	MAX	UNIT
$t_{pd}$ Propagation delay time	A-to-Y	$V_{CC} = 0.8 \text{ V}$		4.5		ns
		$V_{CC} = 1.2 \text{ V} \pm 0.1 \text{ V}$	0.8		3.6	
		$V_{CC} = 1.5 \text{ V} \pm 0.1 \text{ V}$	0.6		2.3	
		$V_{CC} = 1.8 \text{ V} \pm 0.15 \text{ V}$	0.6	1	1.6	
		$V_{CC} = 2.5 \text{ V} \pm 0.2 \text{ V}$	0.5		1.4	
$t_{en}$ Enable time	OE-to-Y	$V_{CC} = 0.8 \text{ V}$		4.9		ns
		$V_{CC} = 1.2 \text{ V} \pm 0.1 \text{ V}$	0.7		3.8	
		$V_{CC} = 1.5 \text{ V} \pm 0.1 \text{ V}$	0.7		2.5	
		$V_{CC} = 1.8 \text{ V} \pm 0.15 \text{ V}$	0.3	0.9	1.9	
		$V_{CC} = 2.5 \text{ V} \pm 0.2 \text{ V}$	0.3		1.5	
$t_{dis}$ Disable time	OE-to-Y	$V_{CC} = 0.8 \text{ V}$		4.9		ns
		$V_{CC} = 1.2 \text{ V} \pm 0.1 \text{ V}$	2.2		4.7	
		$V_{CC} = 1.5 \text{ V} \pm 0.1 \text{ V}$	1.8		4.1	
		$V_{CC} = 1.8 \text{ V} \pm 0.15 \text{ V}$	1.6	2.4	3.5	
		$V_{CC} = 2.5 \text{ V} \pm 0.2 \text{ V}$	1		2.7	

## 6.7 Switching Characteristics: $C_L = 30 \text{ pF}$

over recommended operating free-air temperature range,  $C_L = 30 \text{ pF}$  (unless otherwise noted) (see [Table 2](#))

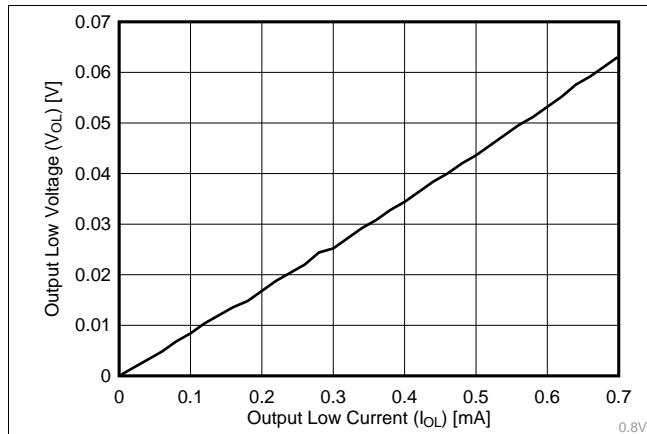
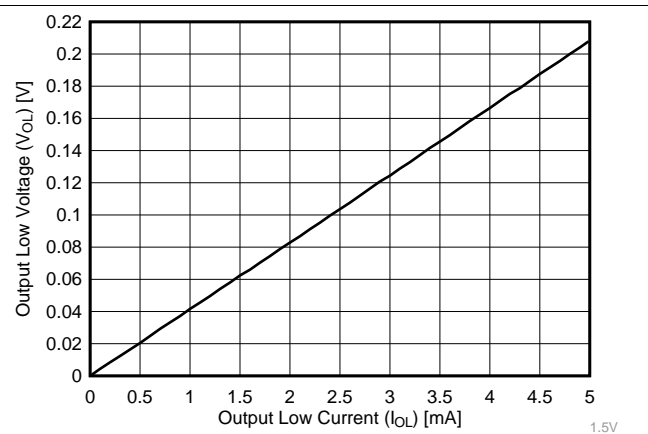
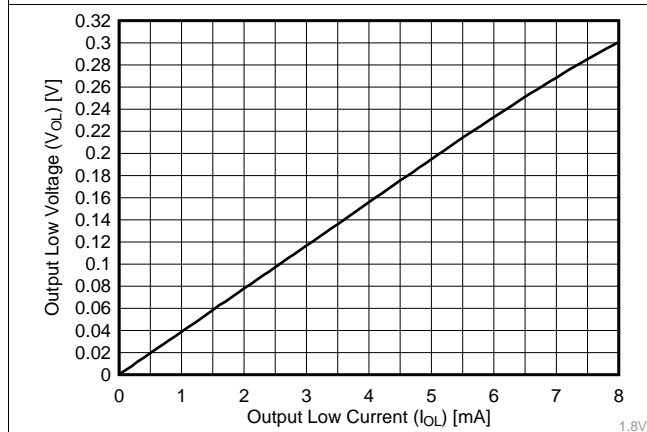
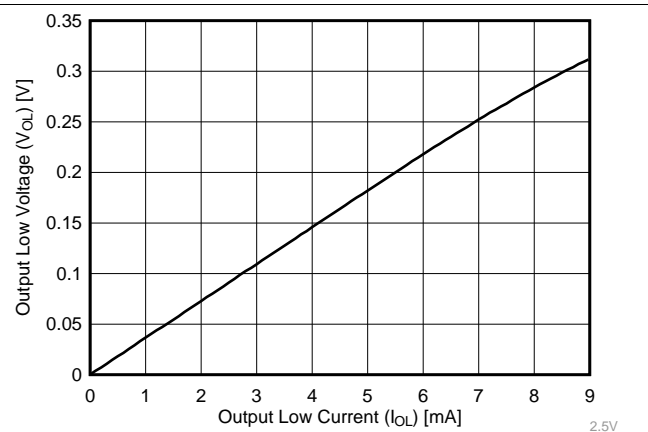
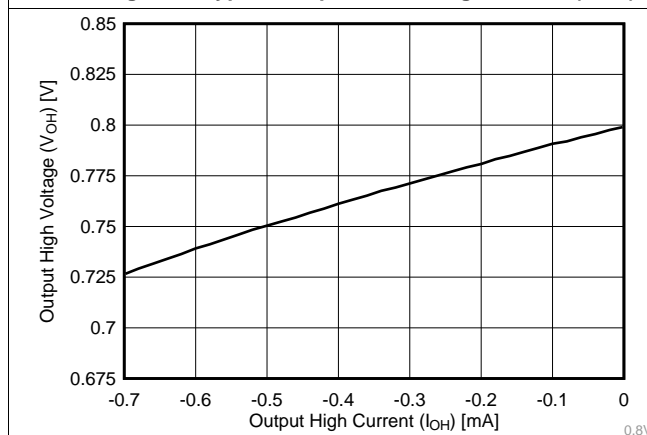
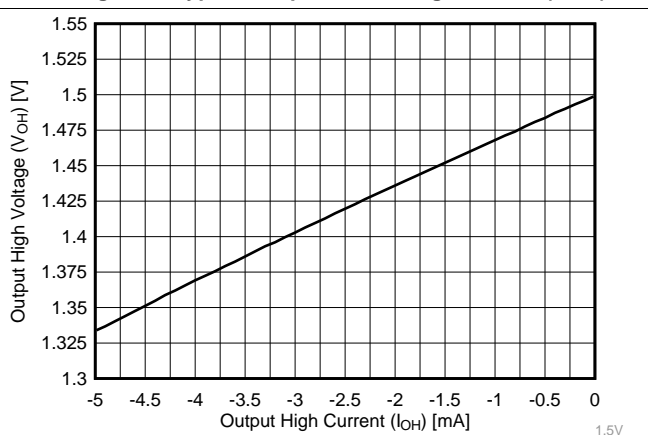
PARAMETER	TEST CONDITIONS		MIN	TYP	MAX	UNIT
$t_{pd}$ Propagation delay time	A-to-Y	$V_{CC} = 1.8 \text{ V} \pm 0.15 \text{ V}$	1	1.5	2.5	ns
		$V_{CC} = 2.5 \text{ V} \pm 0.2 \text{ V}$	0.9		1.7	
$t_{en}$ Enable time	OE-to-Y	$V_{CC} = 1.8 \text{ V} \pm 0.15 \text{ V}$	1.1	1.6	2.5	ns
		$V_{CC} = 2.5 \text{ V} \pm 0.2 \text{ V}$	0.9		1.9	
$t_{dis}$ Disable time	OE-to-Y	$V_{CC} = 1.8 \text{ V} \pm 0.15 \text{ V}$	1.3	2.6	3.1	ns
		$V_{CC} = 2.5 \text{ V} \pm 0.2 \text{ V}$	1		2.1	

## 6.8 Operating Characteristics

$T_A = 25^\circ\text{C}$

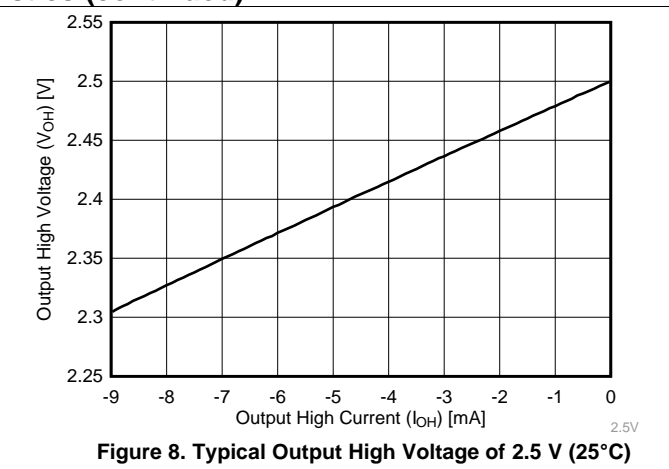
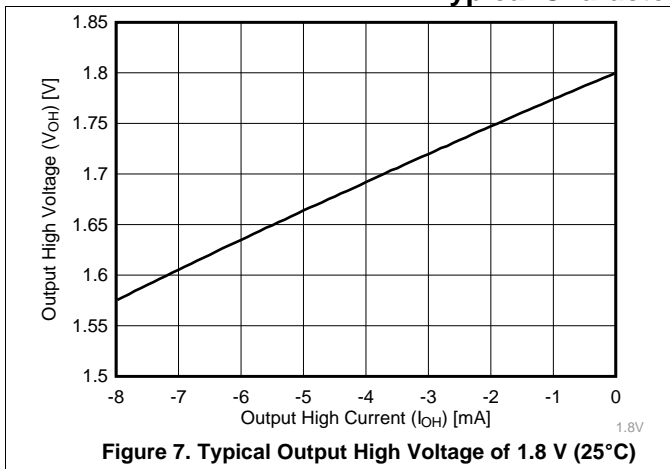
PARAMETER	TEST CONDITIONS		MIN	TYP	MAX	UNIT
$C_{pd}$ Power dissipation capacitance	f = 10 MHz	Inputs disabled	$V_{CC} = 0.8 \text{ V}$		14	pF
			$V_{CC} = 1.2 \text{ V}$		14	
			$V_{CC} = 1.5 \text{ V}$		14	
			$V_{CC} = 1.8 \text{ V}$		15	
			$V_{CC} = 2.5 \text{ V}$		16	
		Outputs disabled	$V_{CC} = 0.8 \text{ V}$		1.5	
			$V_{CC} = 1.2 \text{ V}$		1.5	
			$V_{CC} = 1.5 \text{ V}$		1.5	
			$V_{CC} = 1.8 \text{ V}$		2	
			$V_{CC} = 2.5 \text{ V}$		2.5	

## 7 Typical Characteristics


**Figure 1. Typical Output Low Voltage of 0.8 V (25°C)**

**Figure 2. Typical Output Low Voltage of 1.5 V (25°C)**

**Figure 3. Typical Output Low Voltage of 1.8 V (25°C)**

**Figure 4. Typical Output Low Voltage of 2.5 V (25°C)**

**Figure 5. Typical Output High Voltage of 0.8 V (25°C)**

**Figure 6. Typical Output High Voltage of 1.5 V (25°C)**



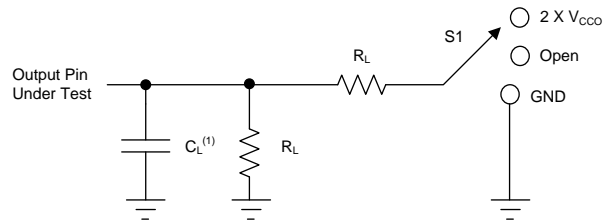
**Typical Characteristics (continued)**



## 8 Parameter Measurement Information

Unless otherwise noted, all input pulses are supplied by generators that have the following characteristics:

- $PRR \leq 10 \text{ MHz}$
- $Z_O = 50 \Omega$



(1)  $C_L$  includes probe and jig capacitance.

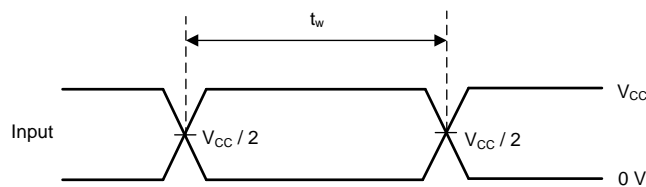
**Figure 9. Load Circuit**

**Table 1. Loading Conditions for Parameter**

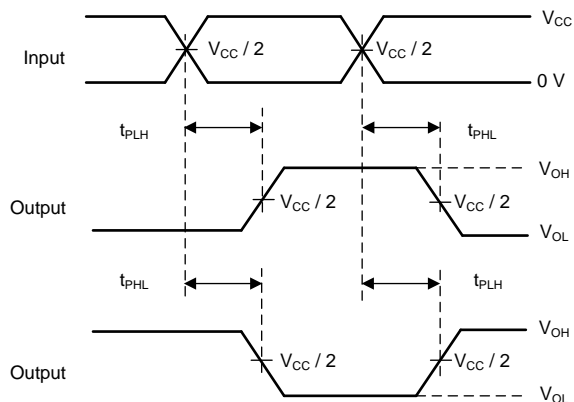
TEST	S1
$t_{PLH}^{(1)}$ , $t_{PHL}^{(1)}$	Open
$t_{PLZ}^{(2)}$ , $t_{PZL}^{(3)}$	$2 \times V_{CC}$
$t_{PHZ}^{(2)}$ , $t_{PZH}^{(3)}$	GND

**Table 2. Loading Conditions for  $V_{CC}$**

$V_{CC}$	$C_L$	$R_L$	$V_{\Delta}$
0.8 V	15 pF	2 k $\Omega$	0.1 V
1.2 V $\pm$ 0.1 V	15 pF	2 k $\Omega$	0.1 V
1.5 V $\pm$ 0.1 V	15 pF	2 k $\Omega$	0.1 V
1.8 V $\pm$ 0.15 V	15 pF	2 k $\Omega$	0.15 V
2.5 V $\pm$ 0.2 V	15 pF	2 k $\Omega$	0.15 V
1.8 V $\pm$ 0.15 V	30 pF	1 k $\Omega$	0.15 V
2.5 V $\pm$ 0.2 V	30 pF	500 k $\Omega$	0.15 V

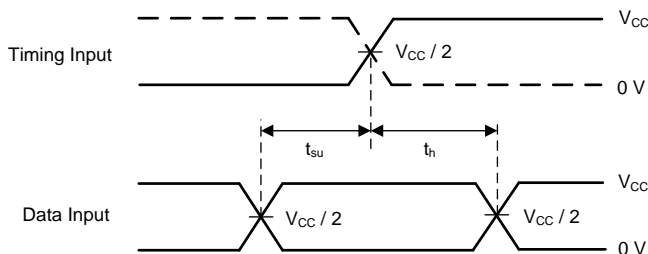


**Figure 10. Voltage Waveforms: Pulse Duration**

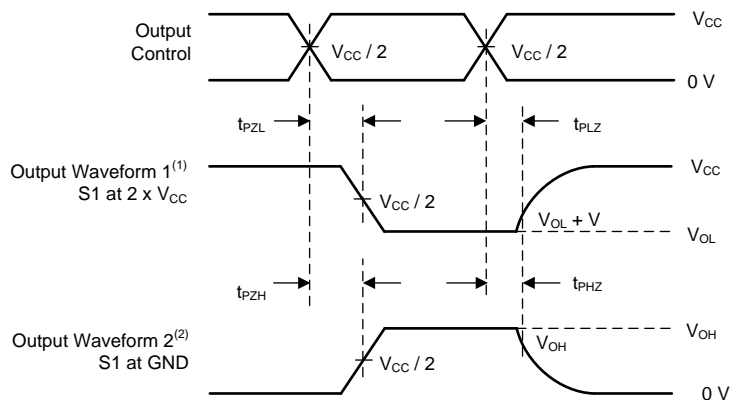


(1) All outputs are measured one at a time, with one transition per measurement.

**Figure 11. Voltage Waveforms: Propagation Delay Times, Inverting and Noninverting Outputs**



**Figure 12. Voltage Waveforms: Setup and Hold Times**



- (1) Waveform 1 is for an output with internal conditions such as the output is low, except when disabled by the output control.
- (2) Waveform 2 is for an output with internal conditions such as the output is high, except when disabled by the output control.
- (3) All outputs are measured one at a time, with one transition per measurement.

**Figure 13. Voltage Waveforms: Enable and Disable Times, Low- and High-Level Enabling**

## 9 Detailed Description

### 9.1 Overview

The SN74AUC1G126 device contains one buffer gate device with output enable control, and performs the Boolean function  $Y = A$ . This device is specified for partial-power-down applications using  $I_{off}$ . The  $I_{off}$  circuitry disables the outputs when the device is powered down. This inhibits current backflow, preventing damage to the device.

To ensure the high-impedance state during power up or power down, OE must be tied to GND through a pullup resistor; the minimum value of the resistor is determined by the current-sinking capability of the driver.

### 9.2 Functional Block Diagram

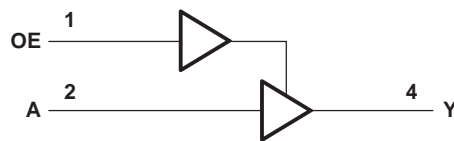


Figure 14. Logic Diagram (Positive Logic)

### 9.3 Feature Description

#### 9.3.1 Balanced CMOS Push-Pull Outputs

A balanced output allows the device to sink and source similar currents. The drive capability of this device may create fast edges into light loads, so routing and load conditions should be considered to prevent ringing. Additionally, the outputs of this device are capable of driving larger currents than the device can sustain without being damaged. It is important for the output power of the device to be limited to avoid damage due to over-current. The electrical and thermal limits defined in the [Absolute Maximum Ratings](#) must be followed at all times.

#### 9.3.2 Standard CMOS Inputs

Standard CMOS inputs are high impedance and are typically modeled as a resistor in parallel with the input capacitance given in the [Electrical Characteristics](#). The worst case resistance is calculated with the maximum input voltage, given in [Absolute Maximum Ratings](#), and the maximum input leakage current, given in [Electrical Characteristics](#), using Ohm's law ( $R = V \div I$ ).

Signals applied to the inputs need to have fast edge rates, as defined by  $\Delta t/\Delta v$  in [Recommended Operating Conditions](#) to avoid excessive current consumption and oscillations. If a slow or noisy input signal is required, a device with a Schmitt-trigger input should be used to condition the input signal prior to the standard CMOS input.

## Feature Description (continued)

### 9.3.3 Negative Clamping Diodes

The inputs and outputs to this device have negative clamping diodes as shown in [Figure 15](#).

**CAUTION**

Voltages beyond the values specified in [Absolute Maximum Ratings](#) table can cause damage to the device. The input negative-voltage and output voltage ratings may be exceeded if the input and output clamp-current ratings are observed.

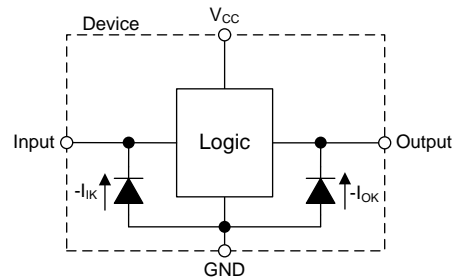


Figure 15. Electrical Placement of Clamping Diodes for Each Input and Output

### 9.3.4 Special Features

#### 9.3.4.1 Partial Power Down ( $I_{off}$ )

The inputs and outputs for this device enter a high-impedance state when the supply voltage is 0 V. The maximum leakage into or out of any input or output pin on the device is specified by  $I_{off}$  in the [Electrical Characteristics](#).

#### 9.3.4.2 Overvoltage Tolerant Inputs

Input signals to this device can be driven above the supply voltage so long as the input signals remain below the maximum input voltage value specified in [Recommended Operating Conditions](#).

#### 9.3.4.3 Output Enable

This device has an output enable (OE) pin that functions according to [Table 3](#). When the outputs of the device are disabled, the outputs are placed into a high impedance state where the output will neither source nor sink current. High-impedance outputs are also commonly referred to as three-state or tri-state outputs. The maximum leakage for the output in this state is defined by  $I_{OZ}$  in the [Electrical Characteristics](#) table.

## 9.4 Device Functional Modes

[Table 3](#) lists the functional modes of the SN74AUC1G126 device.

Table 3. Function Table

INPUTS		OUTPUT
OE	A	Y
H	H	H
H	L	L
L	X	Z

## 10 Application and Implementation

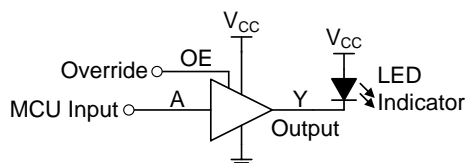
### NOTE

Information in the following applications sections is not part of the TI component specification, and TI does not warrant its accuracy or completeness. TI's customers are responsible for determining suitability of components for their purposes. Customers should validate and test their design implementation to confirm system functionality.

### 10.1 Application Information

The SN74AUC1G126 device is an output enabled CMOS buffer that can be used in LED indicator applications that require less than 9 mA. The device can produce up to 9 mA of drive current at 2.5 V. The inputs to the device are also overvoltage tolerant up to 3.6 V, allowing the inputs to translate down to any valid  $V_{CC}$ .

### 10.2 Typical Application



**Figure 16. Application Schematic with MCU driving an LED Indicator**

#### 10.2.1 Design Requirements

This device uses CMOS technology, and has a balanced output drive. The output drive strength of this device creates fast edges into light loads, so routing and load conditions should be considered to prevent ringing.

### NOTE

Take care of the output drive to avoid bus contention, because the output can drive currents that exceed maximum limits.

#### 10.2.2 Detailed Design Procedure

##### 1. Recommended Input Conditions:

- Rise time and fall time specifications ( $\Delta t/\Delta V$ ) are shown in the [Recommended Operating Conditions](#) table.
- Specified high ( $V_{IH}$ ) and low voltage ( $V_{IL}$ ) levels are shown in the [Recommended Operating Conditions](#) table.
- Inputs are overvoltage tolerant allowing them to go as high as ( $V_I$  maximum) in the [Recommended Operating Conditions](#) table at any valid  $V_{CC}$ .

##### 2. Recommended Output Conditions:

- Load currents must not exceed ( $I_O$  max) per output and must not exceed (continuous current through  $V_{CC}$  or GND) total current for the part. These limits are located in the [Absolute Maximum Ratings](#) table.
- Outputs should not be pulled above  $V_{CC}$ .

## Typical Application (continued)

### 10.2.3 Application Curve

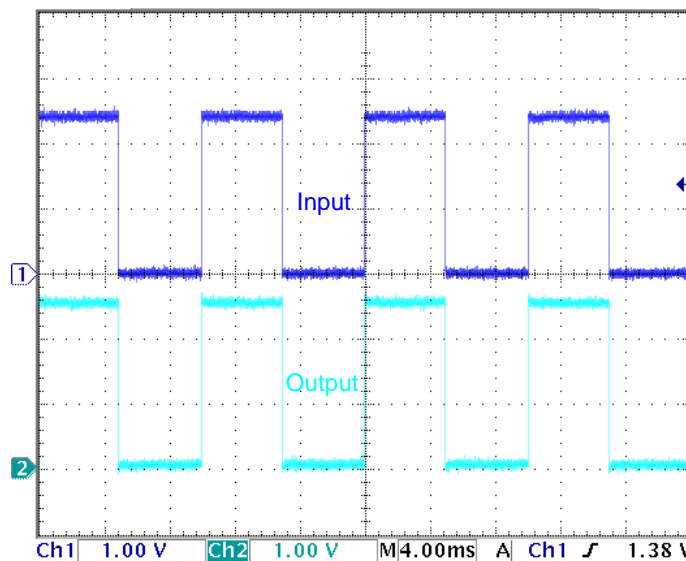


Figure 17. Example Oscilloscope Waveform

## 11 Power Supply Recommendations

The power supply can be any voltage between the minimum and maximum supply voltage rating listed in the [Recommended Operating Conditions](#) table.

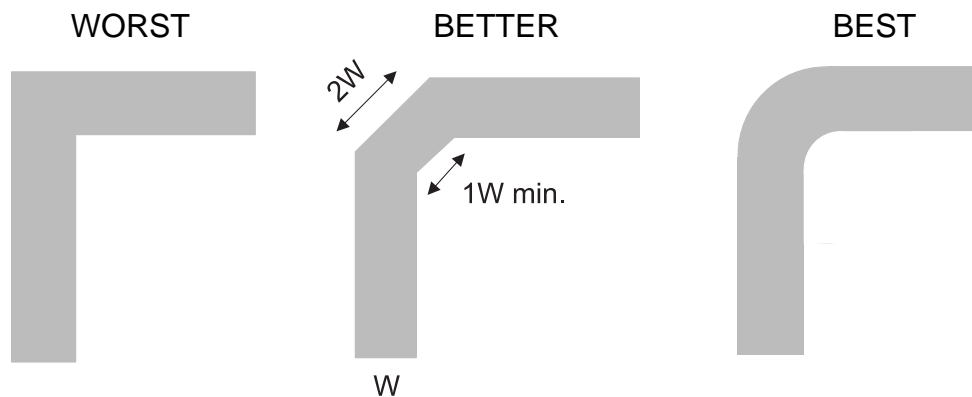
The  $V_{CC}$  pin must have a good bypass capacitor to prevent power disturbance. A 0.1- $\mu\text{F}$  capacitor is recommended, and it is ok to parallel multiple bypass caps to reject different frequencies of noise. 0.1- $\mu\text{F}$  and 1- $\mu\text{F}$  capacitors are commonly used in parallel. The bypass capacitor must be installed as close as possible to the power pin for best results.

## 12 Layout

### 12.1 Layout Guidelines

Even low data rate digital signals can contain high-frequency signal components due to fast edge rates. When a printed-circuit board (PCB) trace turns a corner at a 90° angle, a reflection can occur. A reflection occurs primarily because of the change of width of the trace. At the apex of the turn, the trace width increases to 1.414 times the width. This increase upsets the transmission-line characteristics, especially the distributed capacitance and self-inductance of the trace which results in the reflection. Not all PCB traces can be straight and therefore some traces must turn corners. [Figure 18](#) shows progressively better techniques of rounding corners. Only the last example (BEST) maintains constant trace width and minimizes reflections.

### 12.2 Layout Example



**Figure 18. Trace Example**



## 13 Device and Documentation Support

### 13.1 Documentation Support

#### 13.1.1 Related Documentation

For related documentation see the following:

Texas Instruments, [Implications of Slow or Floating CMOS Inputs application report](#)

### 13.2 Receiving Notification of Documentation Updates

To receive notification of documentation updates, navigate to the device product folder on ti.com. In the upper right corner, click on *Alert me* to register and receive a weekly digest of any product information that has changed. For change details, review the revision history included in any revised document.

### 13.3 Community Resources

The following links connect to TI community resources. Linked contents are provided "AS IS" by the respective contributors. They do not constitute TI specifications and do not necessarily reflect TI's views; see TI's [Terms of Use](#).

**TI E2E™ Online Community** *TI's Engineer-to-Engineer (E2E) Community*. Created to foster collaboration among engineers. At e2e.ti.com, you can ask questions, share knowledge, explore ideas and help solve problems with fellow engineers.

**Design Support** *TI's Design Support* Quickly find helpful E2E forums along with design support tools and contact information for technical support.

### 13.4 Trademarks

NanoFree, E2E are trademarks of Texas Instruments.  
is a trademark of ~Blue-ray Disc Association.  
All other trademarks are the property of their respective owners.

### 13.5 Electrostatic Discharge Caution



This integrated circuit can be damaged by ESD. Texas Instruments recommends that all integrated circuits be handled with appropriate precautions. Failure to observe proper handling and installation procedures can cause damage.

ESD damage can range from subtle performance degradation to complete device failure. Precision integrated circuits may be more susceptible to damage because very small parametric changes could cause the device not to meet its published specifications.

### 13.6 Glossary

[SLYZ022](#) — *TI Glossary*.

This glossary lists and explains terms, acronyms, and definitions.

## 14 Mechanical, Packaging, and Orderable Information

The following pages include mechanical, packaging, and orderable information. This information is the most current data available for the designated devices. This data is subject to change without notice and revision of this document. For browser-based versions of this data sheet, refer to the left-hand navigation.

**PACKAGING INFORMATION**

Orderable Device	Status (1)	Package Type	Package Drawing	Pins	Package Qty	Eco Plan (2)	Lead finish/ Ball material (6)	MSL Peak Temp (3)	Op Temp (°C)	Device Marking (4/5)	Samples
74AUC1G126DCKRG4	ACTIVE	SC70	DCK	5	3000	RoHS & Green	NIPDAU	Level-1-260C-UNLIM	-40 to 85	UNR	<a href="#">Samples</a>
SN74AUC1G126DBVR	ACTIVE	SOT-23	DBV	5	3000	RoHS & Green	NIPDAU	Level-1-260C-UNLIM	-40 to 85	U26R	<a href="#">Samples</a>
SN74AUC1G126DCKR	ACTIVE	SC70	DCK	5	3000	RoHS & Green	NIPDAU	Level-1-260C-UNLIM	-40 to 85	UNR	<a href="#">Samples</a>
SN74AUC1G126YZPR	ACTIVE	DSBGA	YZP	5	3000	RoHS & Green	SNAGCU	Level-1-260C-UNLIM	-40 to 85	(UN, UNN)	<a href="#">Samples</a>

(1) The marketing status values are defined as follows:

**ACTIVE:** Product device recommended for new designs.

**LIFEBUY:** TI has announced that the device will be discontinued, and a lifetime-buy period is in effect.

**NRND:** Not recommended for new designs. Device is in production to support existing customers, but TI does not recommend using this part in a new design.

**PREVIEW:** Device has been announced but is not in production. Samples may or may not be available.

**OBSELETE:** TI has discontinued the production of the device.

(2) **RoHS:** TI defines "RoHS" to mean semiconductor products that are compliant with the current EU RoHS requirements for all 10 RoHS substances, including the requirement that RoHS substance do not exceed 0.1% by weight in homogeneous materials. Where designed to be soldered at high temperatures, "RoHS" products are suitable for use in specified lead-free processes. TI may reference these types of products as "Pb-Free".

**RoHS Exempt:** TI defines "RoHS Exempt" to mean products that contain lead but are compliant with EU RoHS pursuant to a specific EU RoHS exemption.

**Green:** TI defines "Green" to mean the content of Chlorine (Cl) and Bromine (Br) based flame retardants meet JS709B low halogen requirements of <=1000ppm threshold. Antimony trioxide based flame retardants must also meet the <=1000ppm threshold requirement.

(3) MSL, Peak Temp. - The Moisture Sensitivity Level rating according to the JEDEC industry standard classifications, and peak solder temperature.

(4) There may be additional marking, which relates to the logo, the lot trace code information, or the environmental category on the device.

(5) Multiple Device Markings will be inside parentheses. Only one Device Marking contained in parentheses and separated by a "-" will appear on a device. If a line is indented then it is a continuation of the previous line and the two combined represent the entire Device Marking for that device.

(6) Lead finish/Ball material - Orderable Devices may have multiple material finish options. Finish options are separated by a vertical ruled line. Lead finish/Ball material values may wrap to two lines if the finish value exceeds the maximum column width.

**Important Information and Disclaimer:**The information provided on this page represents TI's knowledge and belief as of the date that it is provided. TI bases its knowledge and belief on information provided by third parties, and makes no representation or warranty as to the accuracy of such information. Efforts are underway to better integrate information from third parties. TI has taken and

continues to take reasonable steps to provide representative and accurate information but may not have conducted destructive testing or chemical analysis on incoming materials and chemicals. TI and TI suppliers consider certain information to be proprietary, and thus CAS numbers and other limited information may not be available for release.

In no event shall TI's liability arising out of such information exceed the total purchase price of the TI part(s) at issue in this document sold by TI to Customer on an annual basis.

**TAPE AND REEL INFORMATION**

**QUADRANT ASSIGNMENTS FOR PIN 1 ORIENTATION IN TAPE**


\*All dimensions are nominal

Device	Package Type	Package Drawing	Pins	SPQ	Reel Diameter (mm)	Reel Width W1 (mm)	A0 (mm)	B0 (mm)	K0 (mm)	P1 (mm)	W (mm)	Pin1 Quadrant
SN74AUC1G126DBVR	SOT-23	DBV	5	3000	180.0	8.4	3.23	3.17	1.37	4.0	8.0	Q3
SN74AUC1G126DCKR	SC70	DCK	5	3000	180.0	8.4	2.47	2.3	1.25	4.0	8.0	Q3
SN74AUC1G126YZPR	DSBGA	YZP	5	3000	178.0	9.2	1.02	1.52	0.63	4.0	8.0	Q1

## TAPE AND REEL BOX DIMENSIONS



\*All dimensions are nominal

Device	Package Type	Package Drawing	Pins	SPQ	Length (mm)	Width (mm)	Height (mm)
SN74AUC1G126DBVR	SOT-23	DBV	5	3000	202.0	201.0	28.0
SN74AUC1G126DCKR	SC70	DCK	5	3000	202.0	201.0	28.0
SN74AUC1G126YZPR	DSBGA	YZP	5	3000	220.0	220.0	35.0



# EXAMPLE BOARD LAYOUT

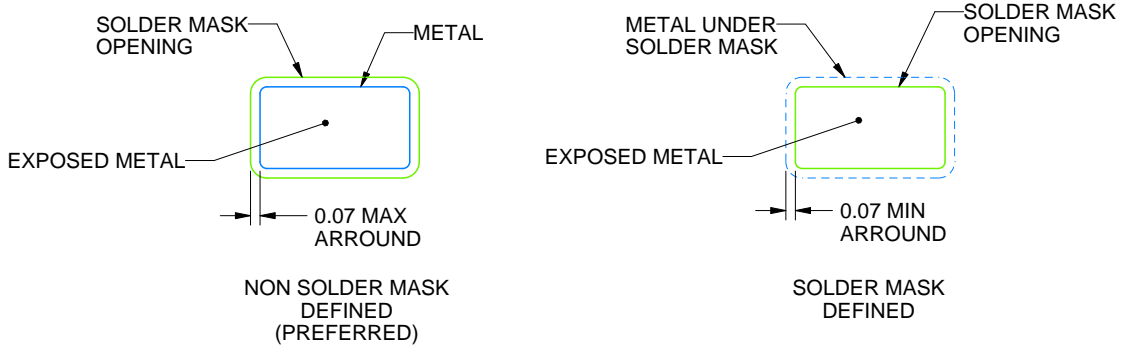
DBV0005A

SOT-23 - 1.45 mm max height

SMALL OUTLINE TRANSISTOR



LAND PATTERN EXAMPLE  
EXPOSED METAL SHOWN  
SCALE:15X



SOLDER MASK DETAILS

4214839/K 08/2024

NOTES: (continued)

- 6. Publication IPC-7351 may have alternate designs.
- 7. Solder mask tolerances between and around signal pads can vary based on board fabrication site.

# EXAMPLE STENCIL DESIGN

DBV0005A

SOT-23 - 1.45 mm max height

SMALL OUTLINE TRANSISTOR



SOLDER PASTE EXAMPLE  
BASED ON 0.125 mm THICK STENCIL  
SCALE:15X

4214839/K 08/2024

NOTES: (continued)

8. Laser cutting apertures with trapezoidal walls and rounded corners may offer better paste release. IPC-7525 may have alternate design recommendations.
9. Board assembly site may have different recommendations for stencil design.



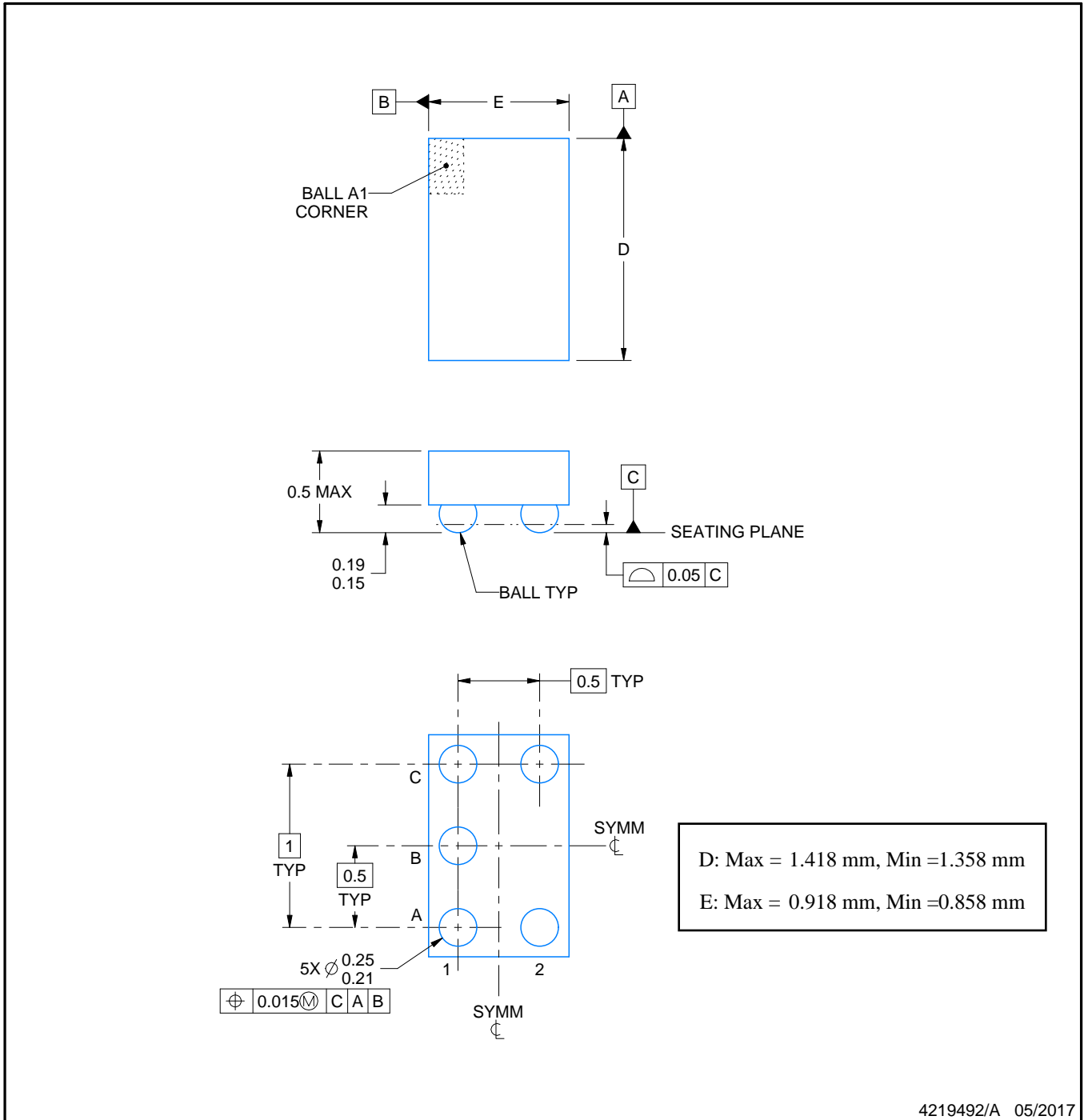
YZP0005



PACKAGE OUTLINE

DSBGA - 0.5 mm max height

DIE SIZE BALL GRID ARRAY



NOTES:

1. All linear dimensions are in millimeters. Any dimensions in parenthesis are for reference only. Dimensioning and tolerancing per ASME Y14.5M.
2. This drawing is subject to change without notice.

# EXAMPLE BOARD LAYOUT

YZP0005

DSBGA - 0.5 mm max height

DIE SIZE BALL GRID ARRAY



LAND PATTERN EXAMPLE  
SCALE:40X



SOLDER MASK DETAILS  
NOT TO SCALE

4219492/A 05/2017

NOTES: (continued)

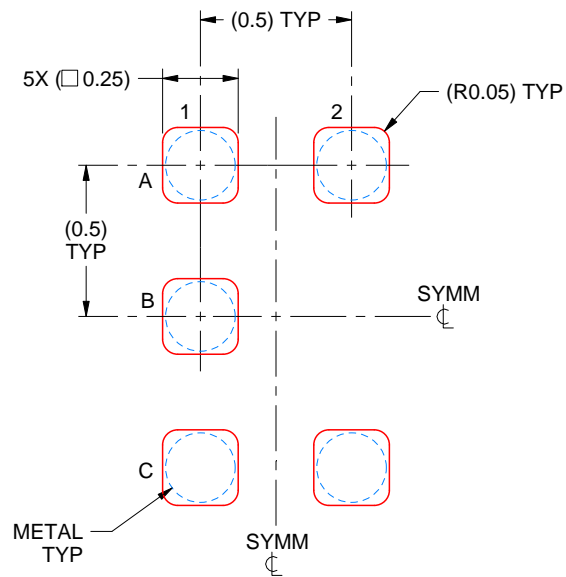
- Final dimensions may vary due to manufacturing tolerance considerations and also routing constraints. For more information, see Texas Instruments literature number SNVA009 ([www.ti.com/lit/snva009](http://www.ti.com/lit/snva009)).

# EXAMPLE STENCIL DESIGN

YZP0005

DSBGA - 0.5 mm max height

DIE SIZE BALL GRID ARRAY



SOLDER PASTE EXAMPLE  
BASED ON 0.1 mm THICK STENCIL  
SCALE:40X

4219492/A 05/2017

NOTES: (continued)

4. Laser cutting apertures with trapezoidal walls and rounded corners may offer better paste release.

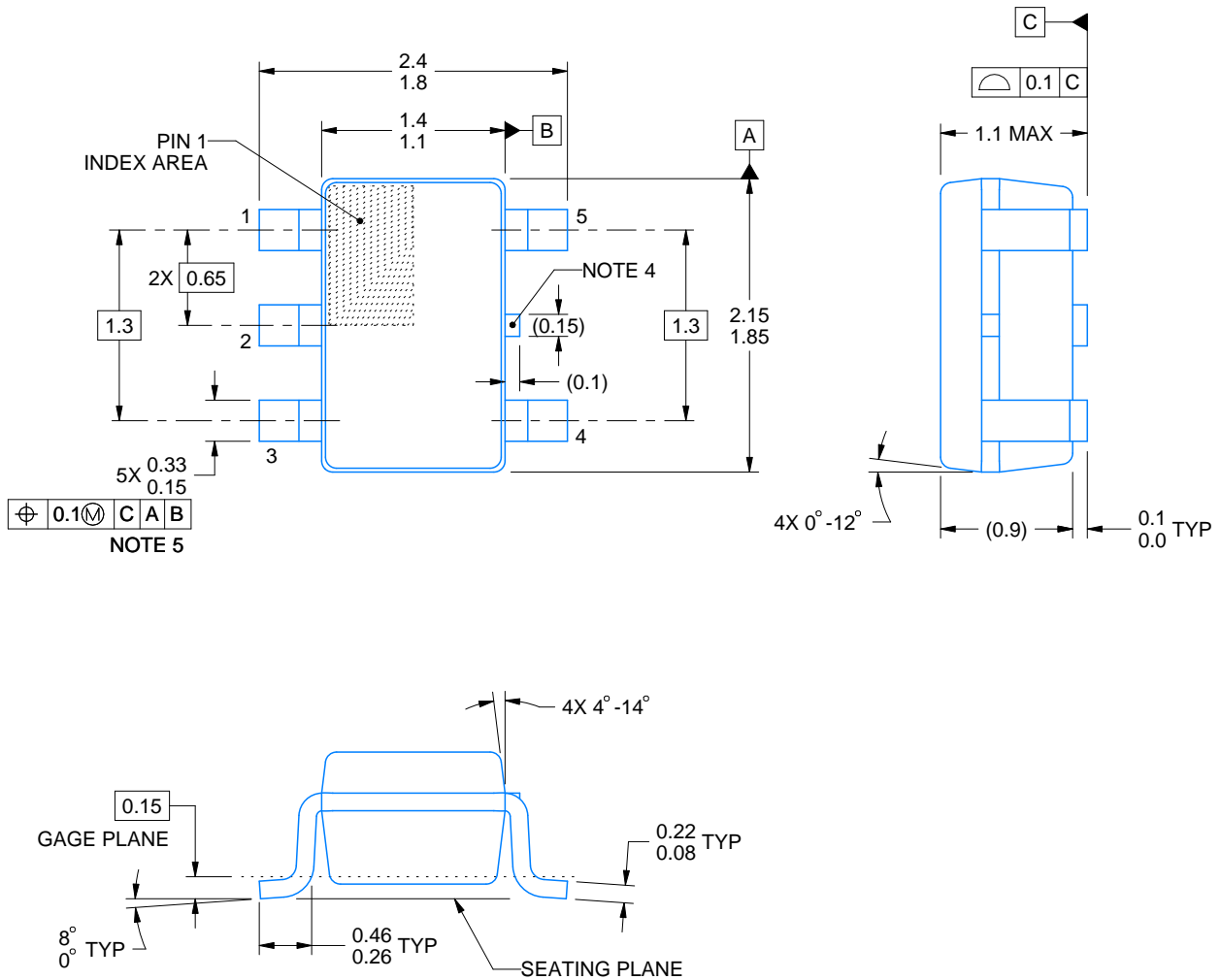
# DCK0005A



# PACKAGE OUTLINE

SOT - 1.1 max height

SMALL OUTLINE TRANSISTOR



4214834/F 08/2024

## NOTES:

1. All linear dimensions are in millimeters. Any dimensions in parenthesis are for reference only. Dimensioning and tolerancing per ASME Y14.5M.
2. This drawing is subject to change without notice.
3. Reference JEDEC MO-203.
4. Support pin may differ or may not be present.
5. Lead width does not comply with JEDEC.
6. Body dimensions do not include mold flash, protrusions, or gate burrs. Mold flash, protrusions, or gate burrs shall not exceed 0.25mm per side

# EXAMPLE BOARD LAYOUT

DCK0005A

SOT - 1.1 max height

SMALL OUTLINE TRANSISTOR



LAND PATTERN EXAMPLE  
EXPOSED METAL SHOWN  
SCALE:18X



SOLDER MASK DETAILS

4214834/F 08/2024

NOTES: (continued)

- 7. Publication IPC-7351 may have alternate designs.
- 8. Solder mask tolerances between and around signal pads can vary based on board fabrication site.

# EXAMPLE STENCIL DESIGN

DCK0005A

SOT - 1.1 max height

SMALL OUTLINE TRANSISTOR



SOLDER PASTE EXAMPLE  
BASED ON 0.125 THICK STENCIL  
SCALE: 18X

4214834/F 08/2024

NOTES: (continued)

9. Laser cutting apertures with trapezoidal walls and rounded corners may offer better paste release. IPC-7525 may have alternate design recommendations.
10. Board assembly site may have different recommendations for stencil design.

## IMPORTANT NOTICE AND DISCLAIMER

TI PROVIDES TECHNICAL AND RELIABILITY DATA (INCLUDING DATA SHEETS), DESIGN RESOURCES (INCLUDING REFERENCE DESIGNS), APPLICATION OR OTHER DESIGN ADVICE, WEB TOOLS, SAFETY INFORMATION, AND OTHER RESOURCES "AS IS" AND WITH ALL FAULTS, AND DISCLAIMS ALL WARRANTIES, EXPRESS AND IMPLIED, INCLUDING WITHOUT LIMITATION ANY IMPLIED WARRANTIES OF MERCHANTABILITY, FITNESS FOR A PARTICULAR PURPOSE OR NON-INFRINGEMENT OF THIRD PARTY INTELLECTUAL PROPERTY RIGHTS.

These resources are intended for skilled developers designing with TI products. You are solely responsible for (1) selecting the appropriate TI products for your application, (2) designing, validating and testing your application, and (3) ensuring your application meets applicable standards, and any other safety, security, regulatory or other requirements.

These resources are subject to change without notice. TI grants you permission to use these resources only for development of an application that uses the TI products described in the resource. Other reproduction and display of these resources is prohibited. No license is granted to any other TI intellectual property right or to any third party intellectual property right. TI disclaims responsibility for, and you will fully indemnify TI and its representatives against, any claims, damages, costs, losses, and liabilities arising out of your use of these resources.

TI's products are provided subject to [TI's Terms of Sale](#) or other applicable terms available either on [ti.com](https://www.ti.com) or provided in conjunction with such TI products. TI's provision of these resources does not expand or otherwise alter TI's applicable warranties or warranty disclaimers for TI products.

TI objects to and rejects any additional or different terms you may have proposed.

Mailing Address: Texas Instruments, Post Office Box 655303, Dallas, Texas 75265  
Copyright © 2024, Texas Instruments Incorporated