

MC33272A, MC33274A, NCV33272A, NCV33274A



ON Semiconductor®

<http://onsemi.com>

Operational Amplifiers, Single Supply, High Slew Rate, Low Input Offset Voltage

The MC33272/74 series of monolithic operational amplifiers are quality fabricated with innovative Bipolar design concepts. This dual and quad operational amplifier series incorporates Bipolar inputs along with a patented Zip-R-Trim element for input offset voltage reduction. The MC33272/74 series of operational amplifiers exhibits low input offset voltage and high gain bandwidth product. Dual-doublet frequency compensation is used to increase the slew rate while maintaining low input noise characteristics. Its all NPN output stage exhibits no deadband crossover distortion, large output voltage swing, and an excellent phase and gain margin. It also provides a low open loop high frequency output impedance with symmetrical source and sink AC frequency performance.

Features

- Input Offset Voltage Trimmed to 100 μ V (Typ)
- Low Input Bias Current: 300 nA
- Low Input Offset Current: 3.0 nA
- High Input Resistance: 16 M Ω
- Low Noise: 18 nV/ $\sqrt{\text{Hz}}$ @ 1.0 kHz
- High Gain Bandwidth Product: 24 MHz @ 100 kHz
- High Slew Rate: 10 V/ μ s
- Power Bandwidth: 160 kHz
- Excellent Frequency Stability
- Unity Gain Stable: w/Capacitance Loads to 500 pF
- Large Output Voltage Swing: +14.1 V/ -14.6 V
- Low Total Harmonic Distortion: 0.003%
- Power Supply Drain Current: 2.15 mA per Amplifier
- Single or Split Supply Operation: +3.0 V to +36 V or ± 1.5 V to ± 18 V
- ESD Diodes Provide Added Protection to the Inputs
- NCV Prefix for Automotive and Other Applications Requiring Unique Site and Control Change Requirements; AEC-Q100 Qualified and PPAP Capable
- Pb-Free Packages are Available

DUAL MARKING DIAGRAMS



PDIP-8
P SUFFIX
CASE 626



SOIC-8
D SUFFIX
CASE 751



x = A for MC33272AD/DR2
= N for NCV33272ADR2

QUAD



PDIP-14
P SUFFIX
CASE 646

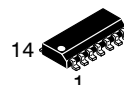

SOIC-14
D SUFFIX
CASE 751A

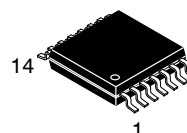
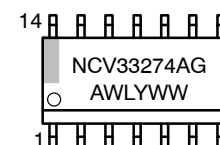

TSSOP-14
DTB SUFFIX
CASE 948G

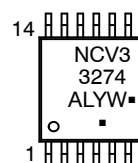
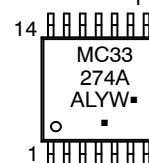

A = Assembly Location
WL, L = Wafer Lot
YY, Y = Year
WW, W = Work Week
G or ■ = Pb-Free Package

(Note: Microdot may be in either location)

ORDERING INFORMATION

See detailed ordering and shipping information in the package dimensions section on page 11 of this data sheet.

MC33272A, MC33274A, NCV33272A, NCV33274A

PIN CONNECTIONS



MAXIMUM RATINGS

Rating	Symbol	Value	Unit
Supply Voltage	V _{CC} to V _{EE}	+36	V
Input Differential Voltage Range	V _{IDR}	Note 1	V
Input Voltage Range	V _{IR}	Note 1	V
Output Short Circuit Duration (Note 2)	t _{SC}	Indefinite	sec
Maximum Junction Temperature	T _J	+150	°C
Storage Temperature	T _{stg}	-60 to +150	°C
ESD Protection at Any Pin	V _{esd}	2000 200	V
	- Human Body Model - Machine Model		
Maximum Power Dissipation	P _D	Note 2	mW
Operating Temperature Range	T _A	-40 to +85 -40 to +125	°C
	MC33272A, MC33274A NCV33272A, NCV33274A		

Stresses exceeding Maximum Ratings may damage the device. Maximum Ratings are stress ratings only. Functional operation above the Recommended Operating Conditions is not implied. Extended exposure to stresses above the Recommended Operating Conditions may affect device reliability.

1. Either or both input voltages should not exceed V_{CC} or V_{EE}.
2. Power dissipation must be considered to ensure maximum junction temperature (T_J) is not exceeded (see Figure 2).

MC33272A, MC33274A, NCV33272A, NCV33274A

DC ELECTRICAL CHARACTERISTICS ($V_{CC} = +15\text{ V}$, $V_{EE} = -15\text{ V}$, $T_A = 25^\circ\text{C}$, unless otherwise noted.)

Characteristics	Figure	Symbol	Min	Typ	Max	Unit
Input Offset Voltage ($R_S = 10\ \Omega$, $V_{CM} = 0\text{ V}$, $V_O = 0\text{ V}$) ($V_{CC} = +15\text{ V}$, $V_{EE} = -15\text{ V}$) $T_A = +25^\circ\text{C}$ $T_A = -40^\circ\text{ to }+85^\circ\text{C}$ $T_A = -40^\circ\text{ to }+125^\circ\text{C}$ (NCV33272A) $T_A = -40^\circ\text{ to }+125^\circ\text{C}$ (NCV33274A) ($V_{CC} = 5.0\text{ V}$, $V_{EE} = 0\text{ V}$) $T_A = +25^\circ\text{C}$	3	$ V_{IO} $	-	0.1	1.0	mV
Average Temperature Coefficient of Input Offset Voltage $R_S = 10\ \Omega$, $V_{CM} = 0\text{ V}$, $V_O = 0\text{ V}$, $T_A = -40^\circ\text{ to }+125^\circ\text{C}$	3	$\Delta V_{IO}/\Delta T$	-	2.0	-	$\mu\text{V}/^\circ\text{C}$
Input Bias Current ($V_{CM} = 0\text{ V}$, $V_O = 0\text{ V}$) $T_A = +25^\circ\text{C}$ $T_A = T_{low}\text{ to }T_{high}$	4, 5	I_{IB}	-	300	650	nA
Input Offset Current ($V_{CM} = 0\text{ V}$, $V_O = 0\text{ V}$) $T_A = +25^\circ\text{C}$ $T_A = T_{low}\text{ to }T_{high}$		$ I_{IO} $	-	3.0	65	nA
Common Mode Input Voltage Range ($\Delta V_{IO} = 5.0\text{ mV}$, $V_O = 0\text{ V}$) $T_A = +25^\circ\text{C}$	6	V_{ICR}	$V_{EE}\text{ to } (V_{CC} - 1.8)$			V
Large Signal Voltage Gain ($V_O = 0\text{ V to }10\text{ V}$, $R_L = 2.0\text{ k}\Omega$) $T_A = +25^\circ\text{C}$ $T_A = T_{low}\text{ to }T_{high}$	7	A_{VOL}	90 86	100 -	- -	dB
Output Voltage Swing ($V_{ID} = \pm 1.0\text{ V}$) ($V_{CC} = +15\text{ V}$, $V_{EE} = -15\text{ V}$) $R_L = 2.0\text{ k}\Omega$ $R_L = 2.0\text{ k}\Omega$ $R_L = 10\text{ k}\Omega$ $R_L = 10\text{ k}\Omega$ ($V_{CC} = 5.0\text{ V}$, $V_{EE} = 0\text{ V}$) $R_L = 2.0\text{ k}\Omega$ $R_L = 2.0\text{ k}\Omega$	8, 9, 12 10, 11	V_{O+} V_{O-} V_{O+} V_{O-} V_{OL} V_{OH}	13.4 - 13.4 - - 3.7	13.9 -13.9 14 -14.7 - -	- -13.5 - -14.1 0.2 5.0	V
Common Mode Rejection ($V_{in} = +13.2\text{ V to }-15\text{ V}$)	13	CMR	80	100	-	dB
Power Supply Rejection $V_{CC}/V_{EE} = +15\text{ V}/-15\text{ V}$, $+5.0\text{ V}/-15\text{ V}$, $+15\text{ V}/-5.0\text{ V}$	14, 15	PSR	80	105	-	dB
Output Short Circuit Current ($V_{ID} = 1.0\text{ V}$, Output to Ground) Source Sink	16	I_{SC}	+25 -25	+37 -37	- -	mA
Power Supply Current Per Amplifier ($V_O = 0\text{ V}$) ($V_{CC} = +15\text{ V}$, $V_{EE} = -15\text{ V}$) $T_A = +25^\circ\text{C}$ $T_A = T_{low}\text{ to }T_{high}$ ($V_{CC} = 5.0\text{ V}$, $V_{EE} = 0\text{ V}$) $T_A = +25^\circ\text{C}$	17	I_{CC}	-	2.15	2.75	mA
			-	-	3.0	
			-	-	2.75	

3. MC33272A, MC33274A $T_{low} = -40^\circ\text{C}$ $T_{high} = +85^\circ\text{C}$
 NCV33272A, NCV33274A $T_{low} = -40^\circ\text{C}$ $T_{high} = +125^\circ\text{C}$

MC33272A, MC33274A, NCV33272A, NCV33274A

AC ELECTRICAL CHARACTERISTICS ($V_{CC} = +15\text{ V}$, $V_{EE} = -15\text{ V}$, $T_A = 25^\circ\text{C}$, unless otherwise noted.)

Characteristics	Figure	Symbol	Min	Typ	Max	Unit
Slew Rate ($V_{in} = -10\text{ V}$ to $+10\text{ V}$, $R_L = 2.0\text{ k}\Omega$, $C_L = 100\text{ pF}$, $A_V = +1.0\text{ V}$)	18, 33	SR	8.0	10	-	$\text{V}/\mu\text{s}$
Gain Bandwidth Product ($f = 100\text{ kHz}$)	19	GBW	17	24	-	MHz
AC Voltage Gain ($R_L = 2.0\text{ k}\Omega$, $V_O = 0\text{ V}$, $f = 20\text{ kHz}$)	20, 21, 22	A_{VO}	-	65	-	dB
Unity Gain Bandwidth (Open Loop)		BW	-	5.5	-	MHz
Gain Margin ($R_L = 2.0\text{ k}\Omega$, $C_L = 0\text{ pF}$)	23, 24, 26	A_m	-	12	-	dB
Phase Margin ($R_L = 2.0\text{ k}\Omega$, $C_L = 0\text{ pF}$)	23, 25, 26	ϕ_m	-	55	-	Deg
Channel Separation ($f = 20\text{ Hz}$ to 20 kHz)	27	CS	-	-120	-	dB
Power Bandwidth ($V_O = 20\text{ V}_{pp}$, $R_L = 2.0\text{ k}\Omega$, $\text{THD} \leq 1.0\%$)		BW_P	-	160	-	kHz
Total Harmonic Distortion ($R_L = 2.0\text{ k}\Omega$, $f = 20\text{ Hz}$ to 20 kHz , $V_O = 3.0\text{ V}_{rms}$, $A_V = +1.0$)	28	THD	-	0.003	-	%
Open Loop Output Impedance ($V_O = 0\text{ V}$, $f = 6.0\text{ MHz}$)	29	$ Z_O $	-	35	-	Ω
Differential Input Resistance ($V_{CM} = 0\text{ V}$)		R_{in}	-	16	-	$\text{M}\Omega$
Differential Input Capacitance ($V_{CM} = 0\text{ V}$)		C_{in}	-	3.0	-	pF
Equivalent Input Noise Voltage ($R_S = 100\ \Omega$, $f = 1.0\text{ kHz}$)	30	e_n	-	18	-	$\text{nV}/\sqrt{\text{Hz}}$
Equivalent Input Noise Current ($f = 1.0\text{ kHz}$)	31	i_n	-	0.5	-	$\text{pA}/\sqrt{\text{Hz}}$



Figure 1. Equivalent Circuit Schematic
(Each Amplifier)

MC33272A, MC33274A, NCV33272A, NCV33274A



Figure 2. Maximum Power Dissipation versus Temperature



Figure 3. Input Offset Voltage versus Temperature for Typical Units



Figure 4. Input Bias Current versus Common Mode Voltage



Figure 5. Input Bias Current versus Temperature



Figure 6. Input Common Mode Voltage Range versus Temperature



Figure 7. Open Loop Voltage Gain versus Temperature

MC33272A, MC33274A, NCV33272A, NCV33274A



Figure 8. Split Supply Output Voltage Swing versus Supply Voltage



Figure 9. Split Supply Output Saturation Voltage versus Load Current



Figure 10. Single Supply Output Saturation Voltage versus Load Resistance to Ground

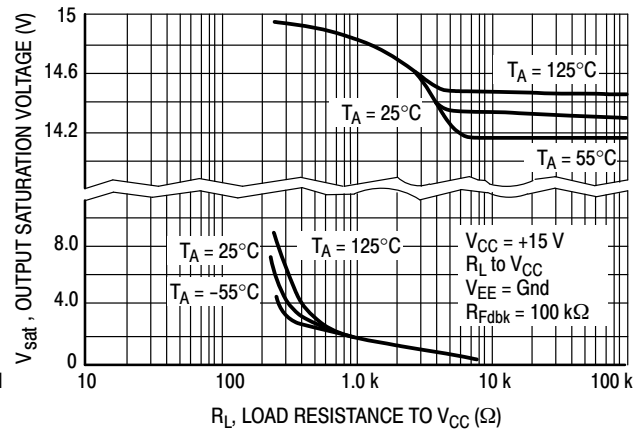

Figure 11. Single Supply Output Saturation Voltage versus Load Resistance to VCC

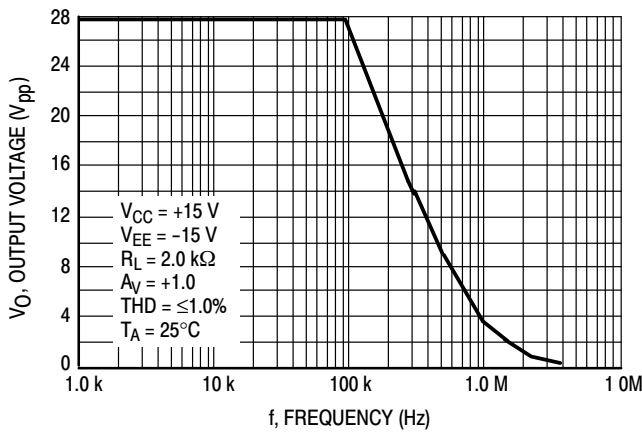

Figure 12. Output Voltage versus Frequency

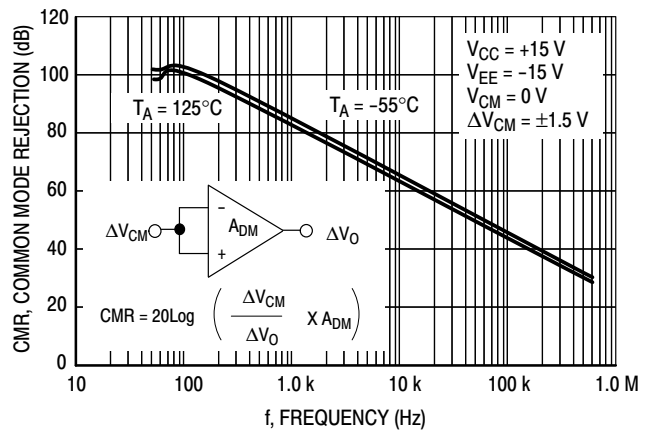

Figure 13. Common Mode Rejection versus Frequency



Figure 14. Positive Power Supply Rejection versus Frequency



Figure 15. Negative Power Supply Rejection versus Frequency



Figure 16. Output Short Circuit Current versus Temperature



Figure 17. Supply Current versus Supply Voltage



Figure 18. Normalized Slew Rate versus Temperature



Figure 19. Gain Bandwidth Product versus Temperature

MC33272A, MC33274A, NCV33272A, NCV33274A



Figure 20. Voltage Gain and Phase versus Frequency



Figure 21. Gain and Phase versus Frequency



Figure 22. Open Loop Voltage Gain and Phase versus Frequency



Figure 23. Open Loop Gain Margin and Phase Margin versus Output Load Capacitance



Figure 24. Open Loop Gain Margin versus Temperature



Figure 25. Phase Margin versus Temperature



Figure 26. Phase Margin and Gain Margin versus Differential Source Resistance



Figure 27. Channel Separation versus Frequency



Figure 28. Total Harmonic Distortion versus Frequency



Figure 29. Output Impedance versus Frequency



Figure 30. Input Referred Noise Voltage versus Frequency

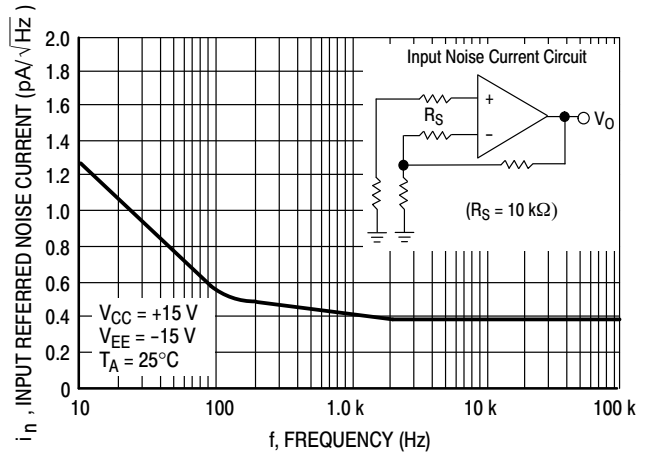

Figure 31. Input Referred Noise Current versus Frequency



Figure 32. Percent Overshoot versus Load Capacitance



Figure 33. Non-inverting Amplifier Slew Rate for the MC33274

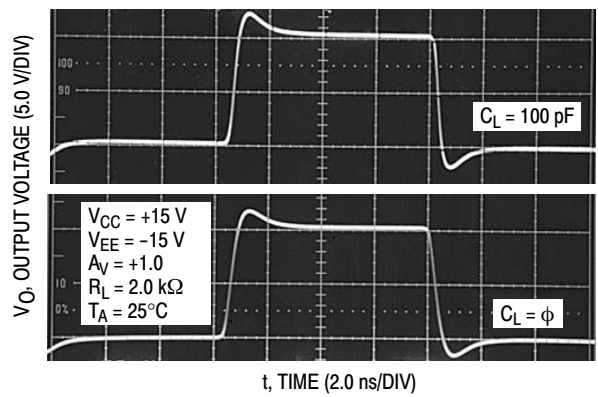

Figure 34. Non-inverting Amplifier Overshoot for the MC33274

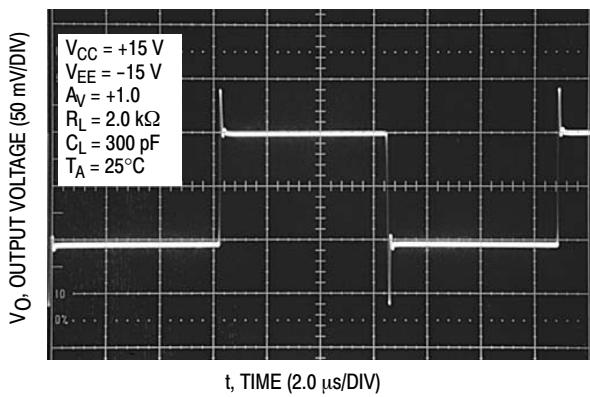

Figure 35. Small Signal Transient Response for MC33274

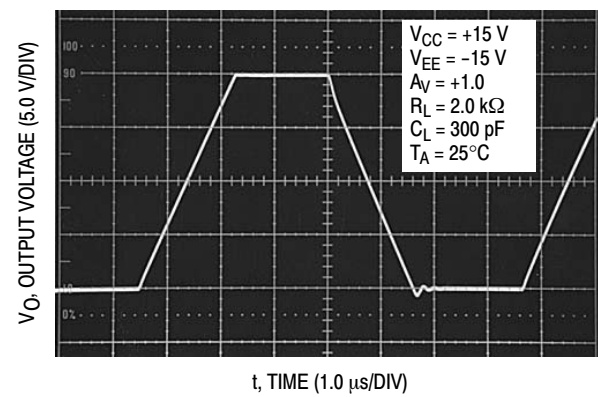

Figure 36. Large Signal Transient Response for MC33274

MC33272A, MC33274A, NCV33272A, NCV33274A

ORDERING INFORMATION

Device	Package	Shipping [†]
MC33272AD	SOIC-8	98 Units / Rail
MC33272ADG	SOIC-8 (Pb-Free)	
MC33272ADR2	SOIC-8	2500 / Tape & Reel
MC33272ADR2G	SOIC-8 (Pb-Free)	
MC33272AP	PDIP-8	50 Units / Rail
MC33272APG	PDIP-8 (Pb-Free)	
NCV33272ADR2*	SOIC-8	2500 / Tape & Reel
NCV33272ADR2G*	SOIC-8 (Pb-Free)	
MC33274AD	SOIC-14	55 Units / Rail
MC33274ADG	SOIC-14 (Pb-Free)	
MC33274ADR2	SOIC-14	2500 / Tape & Reel
MC33274ADR2G	SOIC-14 (Pb-Free)	
MC33274ADTBR2G	TSSOP-14 (Pb-Free)	
MC33274AP	PDIP-14	25 Units / Rail
MC33274APG	PDIP-14 (Pb-Free)	
NCV33274AD*	SOIC-14	55 Units / Rail
NCV33274ADG*	SOIC-14 (Pb-Free)	
NCV33274ADR2*	SOIC-14	2500 / Tape & Reel
NCV33274ADR2G*	SOIC-14 (Pb-Free)	
NCV33274ADTBR2G*	TSSOP-14 (Pb-Free)	

[†]For information on tape and reel specifications, including part orientation and tape sizes, please refer to our Tape and Reel Packaging Specifications Brochure, BRD8011/D.

*NCV Prefix for Automotive and Other Applications Requiring Unique Site and Control Change Requirements; AEC-Q100 Qualified and PPAP Capable.

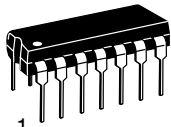

1
SCALE 1:1

PDIP-14
CASE 646-06
ISSUE 5

DATE 22 APR 2015

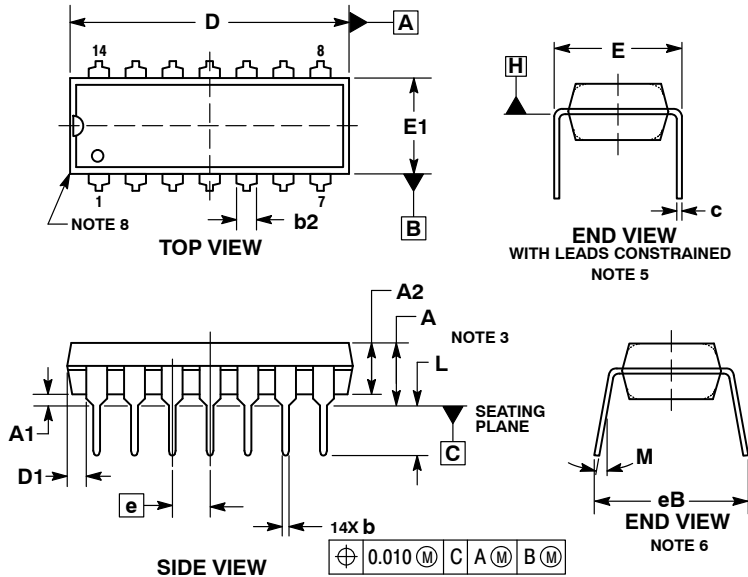

NOTES:

1. DIMENSIONING AND TOLERANCING PER ASME Y14.5M, 1994.
2. CONTROLLING DIMENSION: INCHES.
3. DIMENSIONS A, A1 AND L ARE MEASURED WITH THE PACKAGE SEATED IN JEDEC SEATING PLANE GAUGE GS-3.
4. DIMENSIONS D, D1 AND E1 DO NOT INCLUDE MOLD FLASH OR PROTRUSIONS. MOLD FLASH OR PROTRUSIONS ARE NOT TO EXCEED 0.10 INCH.
5. DIMENSION E IS MEASURED AT A POINT 0.015 BELOW DATUM PLANE H WITH THE LEADS CONSTRAINED PERPENDICULAR TO DATUM C.
6. DIMENSION eB IS MEASURED AT THE LEAD TIPS WITH THE LEADS UNCONSTRAINED.
7. DATUM PLANE H IS COINCIDENT WITH THE BOTTOM OF THE LEADS, WHERE THE LEADS EXIT THE BODY.
8. PACKAGE CONTOUR IS OPTIONAL (ROUNDED OR SQUARE CORNERS).

DIM	INCHES		MILLIMETERS	
	MIN	MAX	MIN	MAX
A	---	0.210	---	5.33
A1	0.015	---	0.38	---
A2	0.115	0.195	2.92	4.95
b	0.014	0.022	0.35	0.56
b2	0.060 TYP 1.52 TYP			
C	0.008	0.014	0.20	0.36
D	0.735	0.775	18.67	19.69
D1	0.005	---	0.13	---
E	0.300	0.325	7.62	8.26
E1	0.240	0.280	6.10	7.11
e	0.100 BSC 2.54 BSC			
eB	---	0.430	---	10.92
L	0.115	0.150	2.92	3.81
M	---	10°	---	10°

GENERIC
MARKING DIAGRAM*

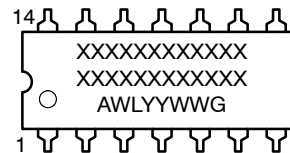

- XXXXX = Specific Device Code
- A = Assembly Location
- WL = Wafer Lot
- YY = Year
- WW = Work Week
- G = Pb-Free Package

*This information is generic. Please refer to device data sheet for actual part marking. Pb-Free indicator, "G" or microdot "•", may or may not be present. Some products may not follow the Generic Marking.

STYLES ON PAGE 2

DOCUMENT NUMBER:	98ASB42428B	Electronic versions are uncontrolled except when accessed directly from the Document Repository. Printed versions are uncontrolled except when stamped "CONTROLLED COPY" in red.
DESCRIPTION:	PDIP-14	PAGE 1 OF 2

onsemi and ONSEMI are trademarks of Semiconductor Components Industries, LLC dba onsemi or its subsidiaries in the United States and/or other countries. onsemi reserves the right to make changes without further notice to any products herein. onsemi makes no warranty, representation or guarantee regarding the suitability of its products for any particular purpose, nor does onsemi assume any liability arising out of the application or use of any product or circuit, and specifically disclaims any and all liability, including without limitation special, consequential or incidental damages. onsemi does not convey any license under its patent rights nor the rights of others.

PDIP-14
CASE 646-06
ISSUE S

DATE 22 APR 2015

STYLE 1:
 PIN 1. COLLECTOR
 2. BASE
 3. EMITTER
 4. NO
 CONNECTION
 5. EMITTER
 6. BASE
 7. COLLECTOR
 8. COLLECTOR
 9. BASE
 10. EMITTER
 11. NO
 CONNECTION
 12. EMITTER
 13. BASE
 14. COLLECTOR

STYLE 2:
 CANCELLED

STYLE 3:
 CANCELLED

STYLE 4:
 PIN 1. DRAIN
 2. SOURCE
 3. GATE
 4. NO
 CONNECTION
 5. GATE
 6. SOURCE
 7. DRAIN
 8. DRAIN
 9. SOURCE
 10. GATE
 11. NO
 CONNECTION
 12. GATE
 13. SOURCE
 14. DRAIN

STYLE 5:
 PIN 1. GATE
 2. DRAIN
 3. SOURCE
 4. NO CONNECTION
 5. SOURCE
 6. DRAIN
 7. GATE
 8. GATE
 9. DRAIN
 10. SOURCE
 11. NO CONNECTION
 12. SOURCE
 13. DRAIN
 14. GATE

STYLE 6:
 PIN 1. COMMON CATHODE
 2. ANODE/CATHODE
 3. ANODE/CATHODE
 4. NO CONNECTION
 5. ANODE/CATHODE
 6. NO CONNECTION
 7. ANODE/CATHODE
 8. ANODE/CATHODE
 9. ANODE/CATHODE
 10. NO CONNECTION
 11. ANODE/CATHODE
 12. ANODE/CATHODE
 13. NO CONNECTION
 14. COMMON ANODE

STYLE 7:
 PIN 1. NO CONNECTION
 2. ANODE
 3. ANODE
 4. NO CONNECTION
 5. ANODE
 6. NO CONNECTION
 7. ANODE
 8. ANODE
 9. ANODE
 10. NO CONNECTION
 11. ANODE
 12. ANODE
 13. NO CONNECTION
 14. COMMON
 CATHODE

STYLE 8:
 PIN 1. NO CONNECTION
 2. CATHODE
 3. CATHODE
 4. NO CONNECTION
 5. CATHODE
 6. NO CONNECTION
 7. CATHODE
 8. CATHODE
 9. CATHODE
 10. NO CONNECTION
 11. CATHODE
 12. CATHODE
 13. NO CONNECTION
 14. COMMON ANODE

STYLE 9:
 PIN 1. COMMON CATHODE
 2. ANODE/CATHODE
 3. ANODE/CATHODE
 4. NO CONNECTION
 5. ANODE/CATHODE
 6. ANODE/CATHODE
 7. COMMON ANODE
 8. COMMON ANODE
 9. ANODE/CATHODE
 10. ANODE/CATHODE
 11. NO CONNECTION
 12. ANODE/CATHODE
 13. ANODE/CATHODE
 14. COMMON CATHODE

STYLE 10:
 PIN 1. COMMON
 CATHODE
 2. ANODE/CATHODE
 3. ANODE/CATHODE
 4. ANODE/CATHODE
 5. ANODE/CATHODE
 6. NO CONNECTION
 7. COMMON ANODE
 8. COMMON
 CATHODE
 9. ANODE/CATHODE
 10. ANODE/CATHODE
 11. ANODE/CATHODE
 12. ANODE/CATHODE
 13. NO CONNECTION
 14. COMMON ANODE

STYLE 11:
 PIN 1. CATHODE
 2. CATHODE
 3. CATHODE
 4. CATHODE
 5. CATHODE
 6. CATHODE
 7. CATHODE
 8. ANODE
 9. ANODE
 10. ANODE
 11. ANODE
 12. ANODE
 13. ANODE
 14. ANODE

STYLE 12:
 PIN 1. COMMON CATHODE
 2. COMMON ANODE
 3. ANODE/CATHODE
 4. ANODE/CATHODE
 5. ANODE/CATHODE
 6. COMMON ANODE
 7. COMMON CATHODE
 8. ANODE/CATHODE
 9. ANODE/CATHODE
 10. ANODE/CATHODE
 11. ANODE/CATHODE
 12. ANODE/CATHODE
 13. ANODE/CATHODE
 14. ANODE/CATHODE

DOCUMENT NUMBER:	98ASB42428B	Electronic versions are uncontrolled except when accessed directly from the Document Repository. Printed versions are uncontrolled except when stamped "CONTROLLED COPY" in red.
DESCRIPTION:	PDIP-14	PAGE 2 OF 2

onsemi and **ONSEMI** are trademarks of Semiconductor Components Industries, LLC dba **onsemi** or its subsidiaries in the United States and/or other countries. **onsemi** reserves the right to make changes without further notice to any products herein. **onsemi** makes no warranty, representation or guarantee regarding the suitability of its products for any particular purpose, nor does **onsemi** assume any liability arising out of the application or use of any product or circuit, and specifically disclaims any and all liability, including without limitation special, consequential or incidental damages. **onsemi** does not convey any license under its patent rights nor the rights of others.



SCALE 1:1

SOIC-8 NB
CASE 751-07
ISSUE AK

DATE 16 FEB 2011



- NOTES:
1. DIMENSIONING AND TOLERANCING PER ANSI Y14.5M, 1982.
 2. CONTROLLING DIMENSION: MILLIMETER.
 3. DIMENSION A AND B DO NOT INCLUDE MOLD PROTRUSION.
 4. MAXIMUM MOLD PROTRUSION 0.15 (0.006) PER SIDE.
 5. DIMENSION D DOES NOT INCLUDE DAMBAR PROTRUSION. ALLOWABLE DAMBAR PROTRUSION SHALL BE 0.127 (0.005) TOTAL IN EXCESS OF THE D DIMENSION AT MAXIMUM MATERIAL CONDITION.
 6. 751-01 THRU 751-06 ARE OBSOLETE. NEW STANDARD IS 751-07.

DIM	MILLIMETERS		INCHES	
	MIN	MAX	MIN	MAX
A	4.80	5.00	0.189	0.197
B	3.80	4.00	0.150	0.157
C	1.35	1.75	0.053	0.069
D	0.33	0.51	0.013	0.020
G	1.27 BSC		0.050 BSC	
H	0.10	0.25	0.004	0.010
J	0.19	0.25	0.007	0.010
K	0.40	1.27	0.016	0.050
M	0°	8°	0°	8°
N	0.25	0.50	0.010	0.020
S	5.80	6.20	0.228	0.244

SOLDERING FOOTPRINT*



*For additional information on our Pb-Free strategy and soldering details, please download the onsemi Soldering and Mounting Techniques Reference Manual, SOLDERRM/D.

GENERIC MARKING DIAGRAM*



XXXXXX = Specific Device Code
A = Assembly Location
L = Wafer Lot
Y = Year
W = Work Week
▪ = Pb-Free Package

XXXXXX = Specific Device Code
A = Assembly Location
Y = Year
WW = Work Week
▪ = Pb-Free Package

*This information is generic. Please refer to device data sheet for actual part marking. Pb-Free indicator, "G" or microdot "▪", may or may not be present. Some products may not follow the Generic Marking.

STYLES ON PAGE 2

DOCUMENT NUMBER:	98ASB42564B	Electronic versions are uncontrolled except when accessed directly from the Document Repository. Printed versions are uncontrolled except when stamped "CONTROLLED COPY" in red.
DESCRIPTION:	SOIC-8 NB	PAGE 1 OF 2

onsemi and onsemi are trademarks of Semiconductor Components Industries, LLC dba onsemi or its subsidiaries in the United States and/or other countries. onsemi reserves the right to make changes without further notice to any products herein. onsemi makes no warranty, representation or guarantee regarding the suitability of its products for any particular purpose, nor does onsemi assume any liability arising out of the application or use of any product or circuit, and specifically disclaims any and all liability, including without limitation special, consequential or incidental damages. onsemi does not convey any license under its patent rights nor the rights of others.

SOIC-8 NB
CASE 751-07
ISSUE AK

DATE 16 FEB 2011

- | | | | |
|--|---|---|---|
| <p>STYLE 1:
 PIN 1. EMITTER
 2. COLLECTOR
 3. COLLECTOR
 4. EMITTER
 5. EMITTER
 6. BASE
 7. BASE
 8. EMITTER</p> | <p>STYLE 2:
 PIN 1. COLLECTOR, DIE, #1
 2. COLLECTOR, #1
 3. COLLECTOR, #2
 4. COLLECTOR, #2
 5. BASE, #2
 6. EMITTER, #2
 7. BASE, #1
 8. EMITTER, #1</p> | <p>STYLE 3:
 PIN 1. DRAIN, DIE #1
 2. DRAIN, #1
 3. DRAIN, #2
 4. DRAIN, #2
 5. GATE, #2
 6. SOURCE, #2
 7. GATE, #1
 8. SOURCE, #1</p> | <p>STYLE 4:
 PIN 1. ANODE
 2. ANODE
 3. ANODE
 4. ANODE
 5. ANODE
 6. ANODE
 7. ANODE
 8. COMMON CATHODE</p> |
| <p>STYLE 5:
 PIN 1. DRAIN
 2. DRAIN
 3. DRAIN
 4. DRAIN
 5. GATE
 6. GATE
 7. SOURCE
 8. SOURCE</p> | <p>STYLE 6:
 PIN 1. SOURCE
 2. DRAIN
 3. DRAIN
 4. SOURCE
 5. SOURCE
 6. GATE
 7. GATE
 8. SOURCE</p> | <p>STYLE 7:
 PIN 1. INPUT
 2. EXTERNAL BYPASS
 3. THIRD STAGE SOURCE
 4. GROUND
 5. DRAIN
 6. GATE 3
 7. SECOND STAGE Vd
 8. FIRST STAGE Vd</p> | <p>STYLE 8:
 PIN 1. COLLECTOR, DIE #1
 2. BASE, #1
 3. BASE, #2
 4. COLLECTOR, #2
 5. COLLECTOR, #2
 6. EMITTER, #2
 7. EMITTER, #1
 8. COLLECTOR, #1</p> |
| <p>STYLE 9:
 PIN 1. EMITTER, COMMON
 2. COLLECTOR, DIE #1
 3. COLLECTOR, DIE #2
 4. EMITTER, COMMON
 5. EMITTER, COMMON
 6. BASE, DIE #2
 7. BASE, DIE #1
 8. EMITTER, COMMON</p> | <p>STYLE 10:
 PIN 1. GROUND
 2. BIAS 1
 3. OUTPUT
 4. GROUND
 5. GROUND
 6. BIAS 2
 7. INPUT
 8. GROUND</p> | <p>STYLE 11:
 PIN 1. SOURCE 1
 2. GATE 1
 3. SOURCE 2
 4. GATE 2
 5. DRAIN 2
 6. DRAIN 2
 7. DRAIN 1
 8. DRAIN 1</p> | <p>STYLE 12:
 PIN 1. SOURCE
 2. SOURCE
 3. SOURCE
 4. GATE
 5. DRAIN
 6. DRAIN
 7. DRAIN
 8. DRAIN</p> |
| <p>STYLE 13:
 PIN 1. N.C.
 2. SOURCE
 3. SOURCE
 4. GATE
 5. DRAIN
 6. DRAIN
 7. DRAIN
 8. DRAIN</p> | <p>STYLE 14:
 PIN 1. N-SOURCE
 2. N-GATE
 3. P-SOURCE
 4. P-GATE
 5. P-DRAIN
 6. P-DRAIN
 7. N-DRAIN
 8. N-DRAIN</p> | <p>STYLE 15:
 PIN 1. ANODE 1
 2. ANODE 1
 3. ANODE 1
 4. ANODE 1
 5. CATHODE, COMMON
 6. CATHODE, COMMON
 7. CATHODE, COMMON
 8. CATHODE, COMMON</p> | <p>STYLE 16:
 PIN 1. EMITTER, DIE #1
 2. BASE, DIE #1
 3. EMITTER, DIE #2
 4. BASE, DIE #2
 5. COLLECTOR, DIE #2
 6. COLLECTOR, DIE #2
 7. COLLECTOR, DIE #1
 8. COLLECTOR, DIE #1</p> |
| <p>STYLE 17:
 PIN 1. VCC
 2. V2OUT
 3. V1OUT
 4. TXE
 5. RXE
 6. VEE
 7. GND
 8. ACC</p> | <p>STYLE 18:
 PIN 1. ANODE
 2. ANODE
 3. SOURCE
 4. GATE
 5. DRAIN
 6. DRAIN
 7. CATHODE
 8. CATHODE</p> | <p>STYLE 19:
 PIN 1. SOURCE 1
 2. GATE 1
 3. SOURCE 2
 4. GATE 2
 5. DRAIN 2
 6. MIRROR 2
 7. DRAIN 1
 8. MIRROR 1</p> | <p>STYLE 20:
 PIN 1. SOURCE (N)
 2. GATE (N)
 3. SOURCE (P)
 4. GATE (P)
 5. DRAIN
 6. DRAIN
 7. DRAIN
 8. DRAIN</p> |
| <p>STYLE 21:
 PIN 1. CATHODE 1
 2. CATHODE 2
 3. CATHODE 3
 4. CATHODE 4
 5. CATHODE 5
 6. COMMON ANODE
 7. COMMON ANODE
 8. CATHODE 6</p> | <p>STYLE 22:
 PIN 1. I/O LINE 1
 2. COMMON CATHODE/VCC
 3. COMMON CATHODE/VCC
 4. I/O LINE 3
 5. COMMON ANODE/GND
 6. I/O LINE 4
 7. I/O LINE 5
 8. COMMON ANODE/GND</p> | <p>STYLE 23:
 PIN 1. LINE 1 IN
 2. COMMON ANODE/GND
 3. COMMON ANODE/GND
 4. LINE 2 IN
 5. LINE 2 OUT
 6. COMMON ANODE/GND
 7. COMMON ANODE/GND
 8. LINE 1 OUT</p> | <p>STYLE 24:
 PIN 1. BASE
 2. EMITTER
 3. COLLECTOR/ANODE
 4. COLLECTOR/ANODE
 5. CATHODE
 6. CATHODE
 7. COLLECTOR/ANODE
 8. COLLECTOR/ANODE</p> |
| <p>STYLE 25:
 PIN 1. VIN
 2. N/C
 3. REXT
 4. GND
 5. IOUT
 6. IOUT
 7. IOUT
 8. IOUT</p> | <p>STYLE 26:
 PIN 1. GND
 2. dv/dt
 3. ENABLE
 4. ILIMIT
 5. SOURCE
 6. SOURCE
 7. SOURCE
 8. VCC</p> | <p>STYLE 27:
 PIN 1. ILIMIT
 2. OVLO
 3. UVLO
 4. INPUT+
 5. SOURCE
 6. SOURCE
 7. SOURCE
 8. DRAIN</p> | <p>STYLE 28:
 PIN 1. SW_TO_GND
 2. DASIC OFF
 3. DASIC_SW_DET
 4. GND
 5. V_MON
 6. VBULK
 7. VBULK
 8. VIN</p> |
| <p>STYLE 29:
 PIN 1. BASE, DIE #1
 2. EMITTER, #1
 3. BASE, #2
 4. EMITTER, #2
 5. COLLECTOR, #2
 6. COLLECTOR, #2
 7. COLLECTOR, #1
 8. COLLECTOR, #1</p> | <p>STYLE 30:
 PIN 1. DRAIN 1
 2. DRAIN 1
 3. GATE 2
 4. SOURCE 2
 5. SOURCE 1/DRAIN 2
 6. SOURCE 1/DRAIN 2
 7. SOURCE 1/DRAIN 2
 8. GATE 1</p> | | |

DOCUMENT NUMBER:	98ASB42564B	Electronic versions are uncontrolled except when accessed directly from the Document Repository. Printed versions are uncontrolled except when stamped "CONTROLLED COPY" in red.
DESCRIPTION:	SOIC-8 NB	PAGE 2 OF 2

onsemi and **ONSEMI** are trademarks of Semiconductor Components Industries, LLC dba **onsemi** or its subsidiaries in the United States and/or other countries. **onsemi** reserves the right to make changes without further notice to any products herein. **onsemi** makes no warranty, representation or guarantee regarding the suitability of its products for any particular purpose, nor does **onsemi** assume any liability arising out of the application or use of any product or circuit, and specifically disclaims any and all liability, including without limitation special, consequential or incidental damages. **onsemi** does not convey any license under its patent rights nor the rights of others.



SCALE 1:1

SOIC-14 NB
CASE 751A-03
ISSUE L

DATE 03 FEB 2016

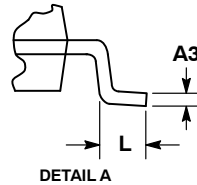
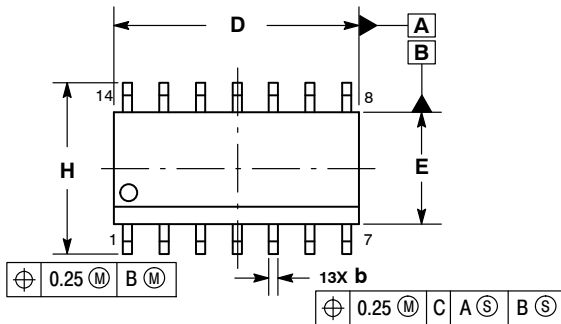

- NOTES:
1. DIMENSIONING AND TOLERANCING PER ASME Y14.5M, 1994.
 2. CONTROLLING DIMENSION: MILLIMETERS.
 3. DIMENSION b DOES NOT INCLUDE DAMBAR PROTRUSION. ALLOWABLE PROTRUSION SHALL BE 0.13 TOTAL IN EXCESS OF AT MAXIMUM MATERIAL CONDITION.
 4. DIMENSIONS D AND E DO NOT INCLUDE MOLD PROTRUSIONS.
 5. MAXIMUM MOLD PROTRUSION 0.15 PER SIDE.

DIM	MILLIMETERS		INCHES	
	MIN	MAX	MIN	MAX
A	1.35	1.75	0.054	0.068
A1	0.10	0.25	0.004	0.010
A3	0.19	0.25	0.008	0.010
b	0.35	0.49	0.014	0.019
D	8.55	8.75	0.337	0.344
E	3.80	4.00	0.150	0.157
e	1.27 BSC		0.050 BSC	
H	5.80	6.20	0.228	0.244
h	0.25	0.50	0.010	0.019
L	0.40	1.25	0.016	0.049
M	0°	7°	0°	7°

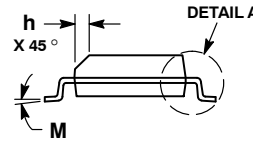
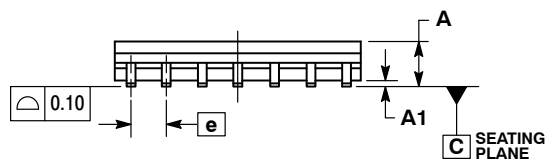

SOLDERING FOOTPRINT*

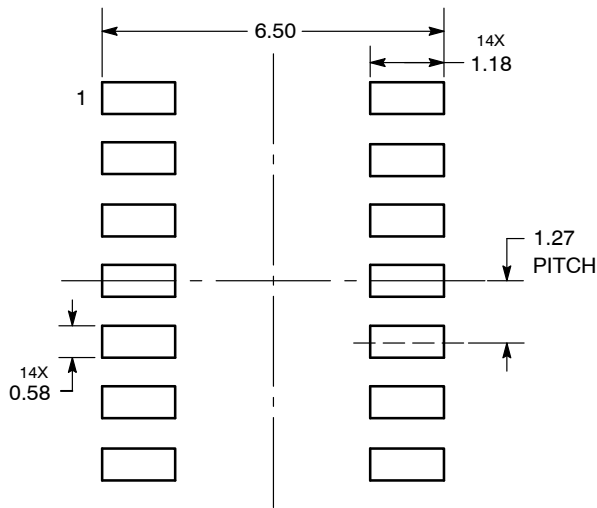

DIMENSIONS: MILLIMETERS

*For additional information on our Pb-Free strategy and soldering details, please download the onsemi Soldering and Mounting Techniques Reference Manual, SOLDERRM/D.

GENERIC MARKING DIAGRAM*

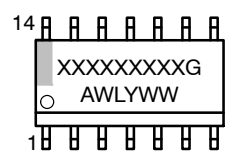

- XXXXXX = Specific Device Code
- A = Assembly Location
- WL = Wafer Lot
- Y = Year
- WW = Work Week
- G = Pb-Free Package

*This information is generic. Please refer to device data sheet for actual part marking. Pb-Free indicator, "G" or microdot "▪", may or may not be present. Some products may not follow the Generic Marking.

STYLES ON PAGE 2

DOCUMENT NUMBER:	98ASB42565B	Electronic versions are uncontrolled except when accessed directly from the Document Repository. Printed versions are uncontrolled except when stamped "CONTROLLED COPY" in red.
DESCRIPTION:	SOIC-14 NB	PAGE 1 OF 2

onsemi and onsemi are trademarks of Semiconductor Components Industries, LLC dba onsemi or its subsidiaries in the United States and/or other countries. onsemi reserves the right to make changes without further notice to any products herein. onsemi makes no warranty, representation or guarantee regarding the suitability of its products for any particular purpose, nor does onsemi assume any liability arising out of the application or use of any product or circuit, and specifically disclaims any and all liability, including without limitation special, consequential or incidental damages. onsemi does not convey any license under its patent rights nor the rights of others.

SOIC-14
CASE 751A-03
ISSUE L

DATE 03 FEB 2016

STYLE 1:
 PIN 1. COMMON CATHODE
 2. ANODE/CATHODE
 3. ANODE/CATHODE
 4. NO CONNECTION
 5. ANODE/CATHODE
 6. NO CONNECTION
 7. ANODE/CATHODE
 8. ANODE/CATHODE
 9. ANODE/CATHODE
 10. NO CONNECTION
 11. ANODE/CATHODE
 12. ANODE/CATHODE
 13. NO CONNECTION
 14. COMMON ANODE

STYLE 2:
 CANCELLED

STYLE 3:
 PIN 1. NO CONNECTION
 2. ANODE
 3. ANODE
 4. NO CONNECTION
 5. ANODE
 6. NO CONNECTION
 7. ANODE
 8. ANODE
 9. ANODE
 10. NO CONNECTION
 11. ANODE
 12. ANODE
 13. NO CONNECTION
 14. COMMON CATHODE

STYLE 4:
 PIN 1. NO CONNECTION
 2. CATHODE
 3. CATHODE
 4. NO CONNECTION
 5. CATHODE
 6. NO CONNECTION
 7. CATHODE
 8. CATHODE
 9. CATHODE
 10. NO CONNECTION
 11. CATHODE
 12. CATHODE
 13. NO CONNECTION
 14. COMMON ANODE

STYLE 5:
 PIN 1. COMMON CATHODE
 2. ANODE/CATHODE
 3. ANODE/CATHODE
 4. ANODE/CATHODE
 5. ANODE/CATHODE
 6. NO CONNECTION
 7. COMMON ANODE
 8. COMMON CATHODE
 9. ANODE/CATHODE
 10. ANODE/CATHODE
 11. ANODE/CATHODE
 12. ANODE/CATHODE
 13. NO CONNECTION
 14. COMMON ANODE

STYLE 6:
 PIN 1. CATHODE
 2. CATHODE
 3. CATHODE
 4. CATHODE
 5. CATHODE
 6. CATHODE
 7. CATHODE
 8. ANODE
 9. ANODE
 10. ANODE
 11. ANODE
 12. ANODE
 13. ANODE
 14. ANODE

STYLE 7:
 PIN 1. ANODE/CATHODE
 2. COMMON ANODE
 3. COMMON CATHODE
 4. ANODE/CATHODE
 5. ANODE/CATHODE
 6. ANODE/CATHODE
 7. ANODE/CATHODE
 8. ANODE/CATHODE
 9. ANODE/CATHODE
 10. ANODE/CATHODE
 11. COMMON CATHODE
 12. COMMON ANODE
 13. ANODE/CATHODE
 14. ANODE/CATHODE

STYLE 8:
 PIN 1. COMMON CATHODE
 2. ANODE/CATHODE
 3. ANODE/CATHODE
 4. NO CONNECTION
 5. ANODE/CATHODE
 6. ANODE/CATHODE
 7. COMMON ANODE
 8. COMMON ANODE
 9. ANODE/CATHODE
 10. ANODE/CATHODE
 11. NO CONNECTION
 12. ANODE/CATHODE
 13. ANODE/CATHODE
 14. COMMON CATHODE

DOCUMENT NUMBER:	98ASB42565B	Electronic versions are uncontrolled except when accessed directly from the Document Repository. Printed versions are uncontrolled except when stamped "CONTROLLED COPY" in red.
DESCRIPTION:	SOIC-14 NB	PAGE 2 OF 2

onsemi and **ONSEMI** are trademarks of Semiconductor Components Industries, LLC dba **onsemi** or its subsidiaries in the United States and/or other countries. **onsemi** reserves the right to make changes without further notice to any products herein. **onsemi** makes no warranty, representation or guarantee regarding the suitability of its products for any particular purpose, nor does **onsemi** assume any liability arising out of the application or use of any product or circuit, and specifically disclaims any and all liability, including without limitation special, consequential or incidental damages. **onsemi** does not convey any license under its patent rights nor the rights of others.

onsemi, **Onsemi**, and other names, marks, and brands are registered and/or common law trademarks of Semiconductor Components Industries, LLC dba "**onsemi**" or its affiliates and/or subsidiaries in the United States and/or other countries. **onsemi** owns the rights to a number of patents, trademarks, copyrights, trade secrets, and other intellectual property. A listing of **onsemi**'s product/patent coverage may be accessed at www.onsemi.com/site/pdf/Patent-Marking.pdf. **onsemi** reserves the right to make changes at any time to any products or information herein, without notice. The information herein is provided "as-is" and **onsemi** makes no warranty, representation or guarantee regarding the accuracy of the information, product features, availability, functionality, or suitability of its products for any particular purpose, nor does **onsemi** assume any liability arising out of the application or use of any product or circuit, and specifically disclaims any and all liability, including without limitation special, consequential or incidental damages. Buyer is responsible for its products and applications using **onsemi** products, including compliance with all laws, regulations and safety requirements or standards, regardless of any support or applications information provided by **onsemi**. "Typical" parameters which may be provided in **onsemi** data sheets and/or specifications can and do vary in different applications and actual performance may vary over time. All operating parameters, including "Typicals" must be validated for each customer application by customer's technical experts. **onsemi** does not convey any license under any of its intellectual property rights nor the rights of others. **onsemi** products are not designed, intended, or authorized for use as a critical component in life support systems or any FDA Class 3 medical devices or medical devices with a same or similar classification in a foreign jurisdiction or any devices intended for implantation in the human body. Should Buyer purchase or use **onsemi** products for any such unintended or unauthorized application, Buyer shall indemnify and hold **onsemi** and its officers, employees, subsidiaries, affiliates, and distributors harmless against all claims, costs, damages, and expenses, and reasonable attorney fees arising out of, directly or indirectly, any claim of personal injury or death associated with such unintended or unauthorized use, even if such claim alleges that **onsemi** was negligent regarding the design or manufacture of the part. **onsemi** is an Equal Opportunity/Affirmative Action Employer. This literature is subject to all applicable copyright laws and is not for resale in any manner.

ADDITIONAL INFORMATION

TECHNICAL PUBLICATIONS:

Technical Library: www.onsemi.com/design/resources/technical-documentation
onsemi Website: www.onsemi.com

ONLINE SUPPORT: www.onsemi.com/support

For additional information, please contact your local Sales Representative at www.onsemi.com/support/sales