

## LM4835 Boomer® Audio Power Amplifier Series Stereo 2W Audio Power Amplifiers with DC Volume Control and Selectable Gain

Check for Samples: [LM4835](#)

### FEATURES

- PC98 Compliant
- DC Volume Control Interface
- System Beep Detect
- Stereo Switchable Bridged/Single-Ended Power Amplifiers
- Selectable Internal/External Gain and Bass Boost Configurable
- “Click and Pop” Suppression Circuitry
- Thermal Shutdown Protection Circuitry

### APPLICATIONS

- Portable and Desktop Computers
- Multimedia Monitors
- Portable Radios, PDAs, and Portable TVs

### KEY SPECIFICATIONS

- $P_O$  at 1% THD+N into 3 $\Omega$  (LM4835LQ, LM4835MTE) 2.2 W (typ)
- $P_O$  at 1% THD+N into 4 $\Omega$  (LM4835LQ, LM4835MTE) 2.0 W (typ)
- $P_O$  at 1% THD+N into 8 $\Omega$  (LM4835) 1.1 W (typ) 1.0 % (typ)
- Single-Ended Mode - THD+N at 85mW into 32 $\Omega$
- Shutdown Current 0.7  $\mu$ A (typ)

### DESCRIPTION

The LM4835 is a monolithic integrated circuit that provides DC volume control, and stereo bridged audio power amplifiers capable of producing 2W into 4 $\Omega$  with less than 1.0% THD or 2.2W into 3 $\Omega$  with less than 1.0% THD (see Notes below).

Boomer™ audio integrated circuits were designed specifically to provide high quality audio while requiring a minimum amount of external components. The LM4835 incorporates a DC volume control, stereo bridged audio power amplifiers and a selectable gain or bass boost, making it optimally suited for multimedia monitors, portable radios, desktop, and portable computer applications.

The LM4835 features an externally controlled, low-power consumption shutdown mode, and both a power amplifier and headphone mute for maximum system flexibility and performance.

**NOTE:** When properly mounted to the circuit board, the LM4835LQ and LM4835MTE will deliver 2W into 4 $\Omega$ . The LM4835MT will deliver 1.1W into 8 $\Omega$ . See the [Application Information](#) section LM4835LQ and for LM4835MTE usage information.

**NOTE:** An LM4835LQ and LM4835MTE that have been properly mounted to the circuit board and forced-air cooled will deliver 2.2W into 3 $\Omega$ .



Please be aware that an important notice concerning availability, standard warranty, and use in critical applications of Texas Instruments semiconductor products and disclaimers thereto appears at the end of this data sheet.

Boomer is a trademark of Texas Instruments.

All other trademarks are the property of their respective owners.

CONNECTION DIAGRAMS

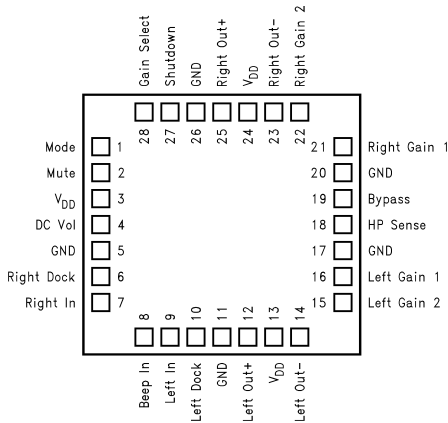

Figure 1. 28-Pin WQFN - Top View  
See NJB0028A Package

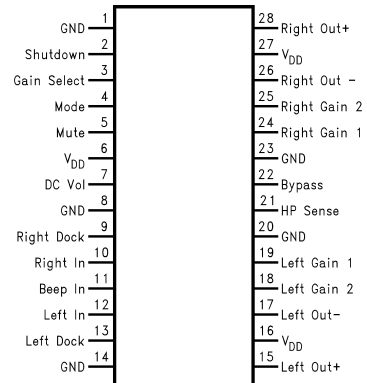

Figure 2. 28-Pin TSSOP - Top View  
See PW Package

BLOCK DIAGRAM

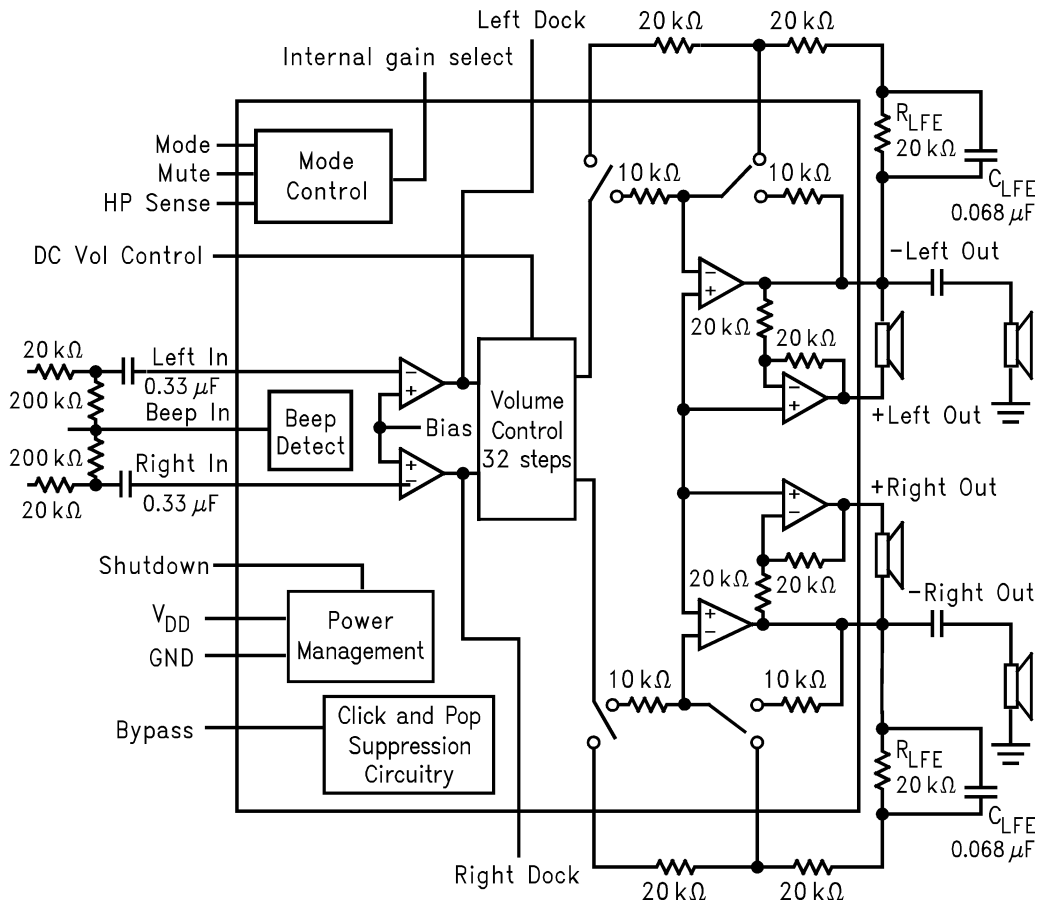

Figure 3. LM4835 Block Diagram



These devices have limited built-in ESD protection. The leads should be shorted together or the device placed in conductive foam during storage or handling to prevent electrostatic damage to the MOS gates.

## ABSOLUTE MAXIMUM RATINGS<sup>(1)(2)</sup>

Supply Voltage		6.0V
Storage Temperature		-65°C to +150°C
Input Voltage		-0.3V to $V_{DD}$ +0.3V
Power Dissipation <sup>(3)</sup>		Internally limited
ESD Susceptibility <sup>(4)</sup>		2000V
ESD Susceptibility <sup>(5)</sup>		200V
Junction Temperature		150°C
Soldering Information	Small Outline Package	Vapor Phase (60 sec.) Infrared (15 sec.)
		215°C 220°C
$\theta_{JC}$ (typ)—LQA028AA		3.0°C/W
$\theta_{JA}$ (typ)—LQA028AA <sup>(6)</sup>		42°C/W
$\theta_{JC}$ (typ)—MTC28		20°C/W
$\theta_{JA}$ (typ)—MTC28		80°C/W
$\theta_{JC}$ (typ)—MXA28A		2°C/W
$\theta_{JA}$ (typ)—MXA28A <sup>(7)</sup>		41°C/W
$\theta_{JA}$ (typ)—MXA28A <sup>(8)</sup>		54°C/W
$\theta_{JA}$ (typ)—MXA28A <sup>(9)</sup>		59°C/W
$\theta_{JA}$ (typ)—MXA28A <sup>(10)</sup>		93°C/W

- (1) Absolute Maximum Ratings indicate limits beyond which damage to the device may occur. Operating Ratings indicate conditions for which the device is functional, but do not ensure specific performance limits. Electrical Characteristics state DC and AC electrical specifications under particular test conditions which ensure specific performance limits. This assumes that the device is within the Operating Ratings. Specifications are not ensured for parameters where no limit is given, however, the typical value is a good indication of device performance.
- (2) If Military/Aerospace specified devices are required, please contact the Texas Instruments Sales Office/Distributors for availability and specifications.
- (3) The maximum power dissipation must be derated at elevated temperatures and is dictated by  $T_{JMAX}$ ,  $\theta_{JA}$ , and the ambient temperature  $T_A$ . The maximum allowable power dissipation is  $P_{DMAX} = (T_{JMAX} - T_A) / \theta_{JA}$ . For the LM4835LQ and LM4835MT,  $T_{JMAX} = 150^\circ\text{C}$ , and the typical junction-to-ambient thermal resistance, when board mounted, is 80°C/W for the MTC28 package and 42°C/W for the LM4835LQ package.
- (4) Human body model, 100pF discharged through a 1.5k $\Omega$  resistor.
- (5) Machine Model, 220pF–240pF discharged through all pins.
- (6) The given  $\theta_{JA}$  is for an LM4835 packaged in an LQA24A with the exposed-DAP soldered to an exposed 2in<sup>2</sup> area of 1oz printed circuit board copper.
- (7) The  $\theta_{JA}$  given is for an MXA28A package whose exposed-DAP is soldered to a 2in<sup>2</sup> piece of 1 ounce printed circuit board copper on a bottom side layer through 21 8mil vias.
- (8) The  $\theta_{JA}$  given is for an MXA28A package whose exposed-DAP is soldered to an exposed 2in<sup>2</sup> piece of 1 ounce printed circuit board copper.
- (9) The  $\theta_{JA}$  given is for an MXA28A package whose exposed-DAP is soldered to an exposed 1in<sup>2</sup> piece of 1 ounce printed circuit board copper.
- (10) The  $\theta_{JA}$  given is for an MXA28A package whose exposed-DAP is not soldered to any copper.

## OPERATING RATINGS

Temperature Range $T_{MIN} \leq T_A \leq T_{MAX}$	-40°C $\leq T_A \leq$ 85°C
Supply Voltage	2.7V $\leq V_{DD} \leq$ 5.5V

## ELECTRICAL CHARACTERISTICS FOR ENTIRE IC<sup>(1)(2)</sup>

The following specifications apply for  $V_{DD} = 5V$  unless otherwise noted. Limits apply for  $T_A = 25^\circ C$ .

Symbol	Parameter	Conditions	LM4835		Units (Limits)
			Typical <sup>(3)</sup>	Limit <sup>(4)</sup>	
$V_{DD}$	Supply Voltage			2.7	V (min)
				5.5	V (max)
$I_{DD}$	Quiescent Power Supply Current	$V_{IN} = 0V, I_O = 0A$	15	30	mA (max)
$I_{SD}$	Shutdown Current	$V_{pin 2} = V_{DD}$	0.7	2.0	$\mu A$ (max)
$V_{IH}$	Headphone Sense High Input Voltage			4	V (min)
$V_{IL}$	Headphone Sense Low Input Voltage			0.8	V (max)

- (1) All voltages are measured with respect to the ground pins, unless otherwise specified. All specifications are tested using the typical application as shown in [Figure 3](#).
- (2) Absolute Maximum Ratings indicate limits beyond which damage to the device may occur. Operating Ratings indicate conditions for which the device is functional, but do not ensure specific performance limits. Electrical Characteristics state DC and AC electrical specifications under particular test conditions which ensure specific performance limits. This assumes that the device is within the Operating Ratings. Specifications are not ensured for parameters where no limit is given, however, the typical value is a good indication of device performance.
- (3) Typicals are measured at  $25^\circ C$  and represent the parametric norm.
- (4) Datasheet min/max specification limits are ensured by design, test, or statistical analysis.

## ELECTRICAL CHARACTERISTICS FOR VOLUME ATTENUATORS<sup>(1)(2)</sup>

The following specifications apply for  $V_{DD} = 5V$ . Limits apply for  $T_A = 25^\circ C$ .

Symbol	Parameter	Conditions	LM4835		Units (Limits)
			Typical <sup>(3)</sup>	Limit <sup>(4)</sup>	
$C_{RANGE}$	Attenuator Range	Gain with $V_{pin 7} = 5V$	0	$\pm 0.5$	dB (max)
		Attenuation with $V_{pin 7} = 0V$	-81	-80	dB (min)
$A_M$	Mute Attenuation	$V_{pin 5} = 5V$ , Bridged Mode	-88	-80	dB (min)
		$V_{pin 5} = 5V$ , Single-Ended Mode	-88	-80	dB (min)

- (1) All voltages are measured with respect to the ground pins, unless otherwise specified. All specifications are tested using the typical application as shown in [Figure 3](#).
- (2) Absolute Maximum Ratings indicate limits beyond which damage to the device may occur. Operating Ratings indicate conditions for which the device is functional, but do not ensure specific performance limits. Electrical Characteristics state DC and AC electrical specifications under particular test conditions which ensure specific performance limits. This assumes that the device is within the Operating Ratings. Specifications are not ensured for parameters where no limit is given, however, the typical value is a good indication of device performance.
- (3) Typicals are measured at  $25^\circ C$  and represent the parametric norm.
- (4) Datasheet min/max specification limits are ensured by design, test, or statistical analysis.

## ELECTRICAL CHARACTERISTICS FOR SINGLE-ENDED MODE OPERATION<sup>(1)(2)</sup>

The following specifications apply for  $V_{DD} = 5V$ . Limits apply for  $T_A = 25^\circ C$ .

Symbol	Parameter	Conditions	LM4835		Units (Limits)
			Typical <sup>(3)</sup>	Limit <sup>(4)</sup>	
P <sub>O</sub>	Output Power	THD = 1.0%; f = 1kHz; R <sub>L</sub> = 32Ω	85		mW
		THD = 10%; f = 1 kHz; R <sub>L</sub> = 32Ω	95		mW
THD+N	Total Harmonic Distortion+Noise	V <sub>OUT</sub> = 1V <sub>RMS</sub> , f=1kHz, R <sub>L</sub> = 10kΩ, A <sub>VD</sub> = 1	0.065		%
PSRR	Power Supply Rejection Ratio	C <sub>B</sub> = 1.0 μF, f = 120 Hz, V <sub>RIPPLE</sub> = 200 mVrms	58		dB
SNR	Signal to Noise Ratio	P <sub>OUT</sub> = 75 mW, R <sub>L</sub> = 32Ω, A-Wtd Filter	102		dB
X <sub>talk</sub>	Channel Separation	f=1kHz, C <sub>B</sub> = 1.0 μF	65		dB

- (1) All voltages are measured with respect to the ground pins, unless otherwise specified. All specifications are tested using the typical application as shown in [Figure 3](#).
- (2) Absolute Maximum Ratings indicate limits beyond which damage to the device may occur. Operating Ratings indicate conditions for which the device is functional, but do not ensure specific performance limits. Electrical Characteristics state DC and AC electrical specifications under particular test conditions which ensure specific performance limits. This assumes that the device is within the Operating Ratings. Specifications are not ensured for parameters where no limit is given, however, the typical value is a good indication of device performance.
- (3) Typical values are measured at 25°C and represent the parametric norm.
- (4) Datasheet min/max specification limits are ensured by design, test, or statistical analysis.

## ELECTRICAL CHARACTERISTICS FOR BRIDGED MODE OPERATION<sup>(1)(2)</sup>

The following specifications apply for  $V_{DD} = 5V$ , unless otherwise noted. Limits apply for  $T_A = 25^\circ C$ .

Symbol	Parameter	Conditions	LM4835		Units (Limits)
			Typical <sup>(3)</sup>	Limit <sup>(4)</sup>	
V <sub>OS</sub>	Output Offset Voltage	V <sub>IN</sub> = 0V	5	30	mV (max)
P <sub>O</sub>	Output Power	THD + N = 1.0%; f=1kHz; R <sub>L</sub> = 3Ω <sup>(5)</sup> <sup>(6)</sup>	2.2		W
		THD + N = 1.0%; f=1kHz; R <sub>L</sub> = 4Ω <sup>(7)</sup> <sup>(6)</sup>	2		W
		THD = 0.5% (max); f = 1 kHz; R <sub>L</sub> = 8Ω	1.1	1.0	W (min)
		THD+N = 10%; f = 1 kHz; R <sub>L</sub> = 8Ω	1.5		W
THD+N	Total Harmonic Distortion+Noise	P <sub>O</sub> = 1W, 20 Hz < f < 20 kHz, R <sub>L</sub> = 8Ω, A <sub>VD</sub> = 2	0.3		%
		P <sub>O</sub> = 340 mW, R <sub>L</sub> = 32Ω	1.0		%
PSRR	Power Supply Rejection Ratio	C <sub>B</sub> = 1.0 μF, f = 120 Hz, V <sub>RIPPLE</sub> = 200 mVrms; R <sub>L</sub> = 8Ω	74		dB
SNR	Signal to Noise Ratio	V <sub>DD</sub> = 5V, P <sub>OUT</sub> = 1.1W, R <sub>L</sub> = 8Ω, A-Wtd Filter	93		dB
X <sub>talk</sub>	Channel Separation	f=1kHz, C <sub>B</sub> = 1.0 μF	70		dB

- (1) All voltages are measured with respect to the ground pins, unless otherwise specified. All specifications are tested using the typical application as shown in [Figure 3](#).
- (2) Absolute Maximum Ratings indicate limits beyond which damage to the device may occur. Operating Ratings indicate conditions for which the device is functional, but do not ensure specific performance limits. Electrical Characteristics state DC and AC electrical specifications under particular test conditions which ensure specific performance limits. This assumes that the device is within the Operating Ratings. Specifications are not ensured for parameters where no limit is given, however, the typical value is a good indication of device performance.
- (3) Typical values are measured at 25°C and represent the parametric norm.
- (4) Datasheet min/max specification limits are ensured by design, test, or statistical analysis.
- (5) When driving 3Ω loads and operating on a 5V supply, the LM4835MTE must be mounted to the circuit board and forced-air cooled.
- (6) When driving a 3Ω or 4Ω loads and operating on a 5V supply, the LM4835LQ must be mounted to the circuit board that has a minimum of 2.5in<sup>2</sup> of exposed, uninterrupted copper area connected to the WQFN package's exposed DAP.
- (7) When driving 4Ω loads and operating on a 5V supply, the LM4835MTE must be mounted to the circuit board.

TYPICAL APPLICATION

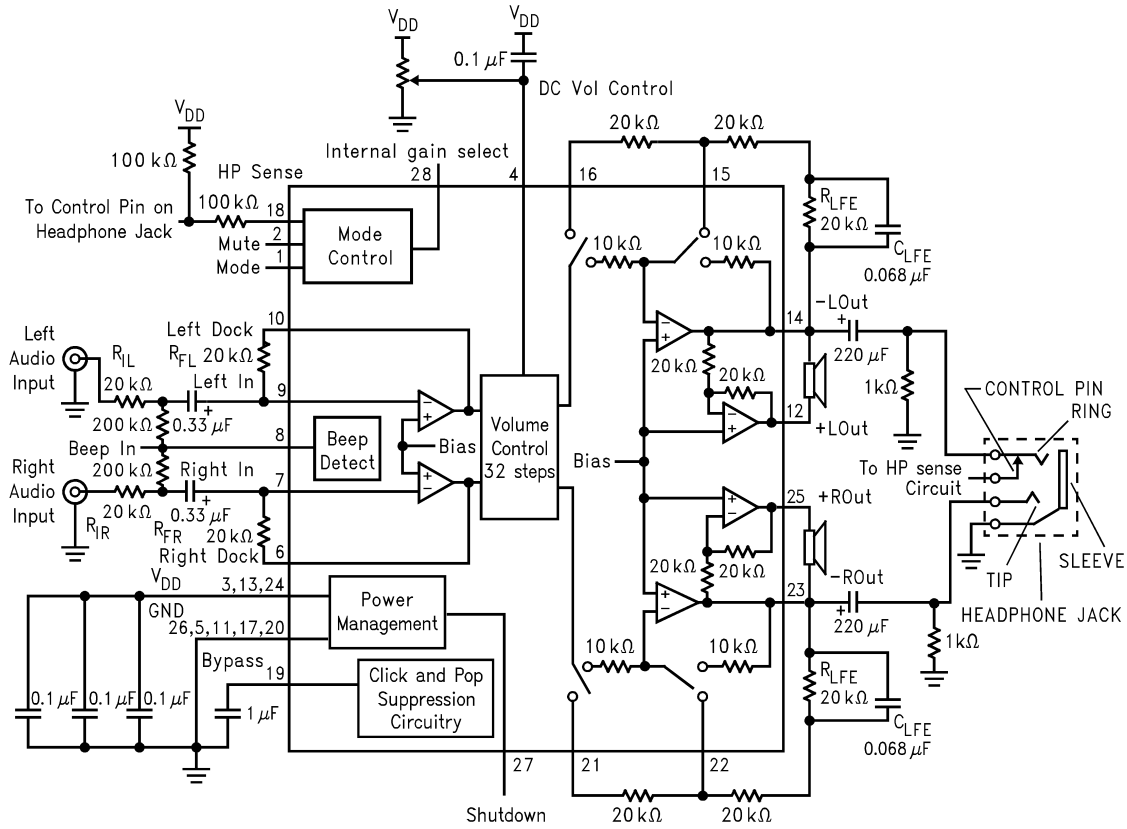

Figure 4. Typical Application Circuit

TRUTH TABLE FOR LOGIC INPUTS<sup>(1)</sup>

Mute	Mode	HP Sense	DC Vol. Control	Bridged Output	Single-Ended Output
0	0	0	Fixed Level	Vol. Fixed	–
0	0	1	Fixed Level	Muted	Vol. Fixed
0	1	0	Adjustable	Vol. Changes	–
0	1	1	Adjustable	Muted	Vol. Changes
1	X	X	–	Muted	Muted

(1) If system beep is detected on the Beep In pin (pin 11), the system beep will be passed through the bridged amplifier regardless of the logic of the Mute and HP sense pins.

TYPICAL PERFORMANCE CHARACTERISTICS  
MTE SPECIFIC CHARACTERISTICS

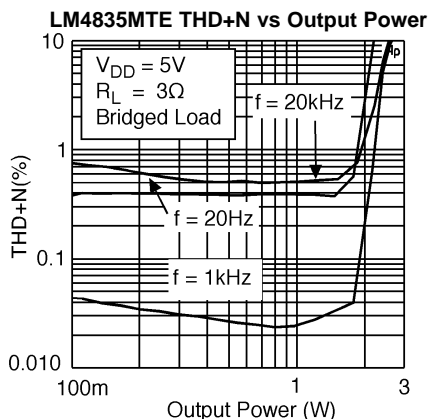

Figure 5.

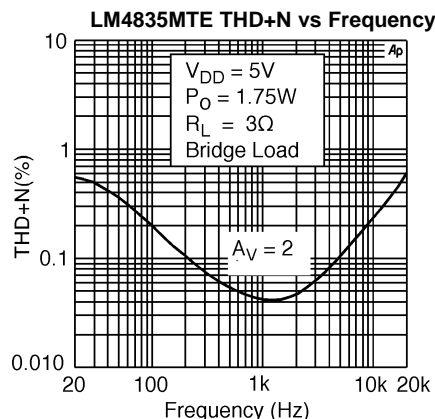

Figure 6.

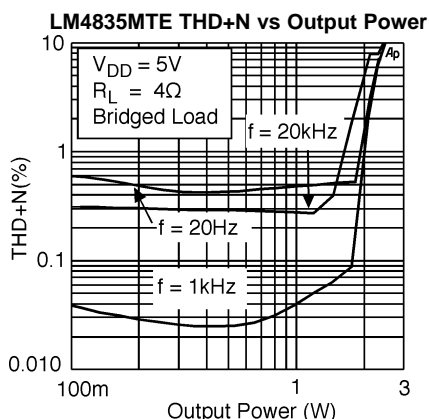

Figure 7.

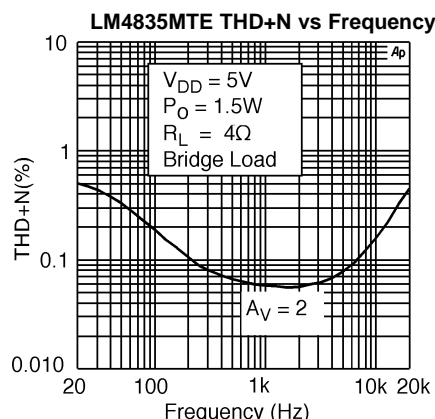

Figure 8.

LM4835MTE Power Dissipation vs Output Power

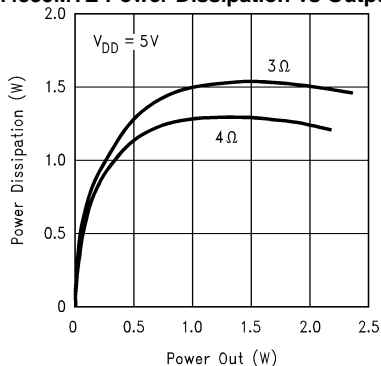

Figure 9.

LM4835MTE Power Derating Curve

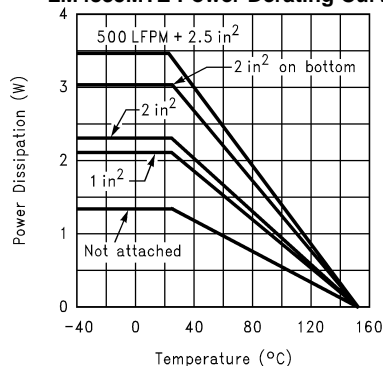
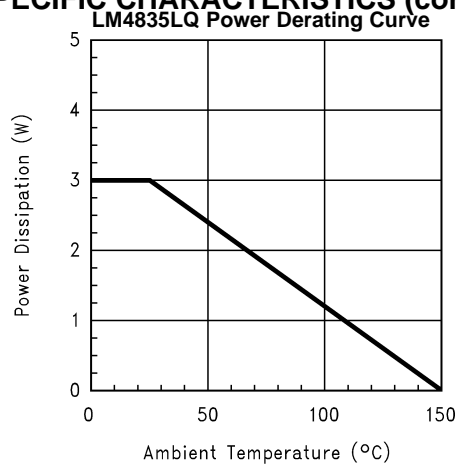

Figure 10.

These curves show the thermal dissipation ability of the LM4835MTE at different ambient temperatures given these conditions:

- 500LFPM + 2in<sup>2</sup>:** The part is soldered to a 2in<sup>2</sup>, 1 oz. copper plane with 500 linear feet per minute of forced-air flow across it.
- 2in<sup>2</sup> on bottom:** The part is soldered to a 2in<sup>2</sup>, 1oz. copper plane that is on the bottom side of the PC board through 21 8 mil vias.
- 2in<sup>2</sup>:** The part is soldered to a 2in<sup>2</sup>, 1oz. copper plane.
- 1in<sup>2</sup>:** The part is soldered to a 1in<sup>2</sup>, 1oz. copper plane.
- Not Attached:** The part is not soldered down and is not forced-air cooled.

**TYPICAL PERFORMANCE CHARACTERISTICS**  
**MTE SPECIFIC CHARACTERISTICS (continued)**



**Figure 11.**



TYPICAL PERFORMANCE CHARACTERISTICS  
NON-MTE SPECIFIC CHARACTERISTICS

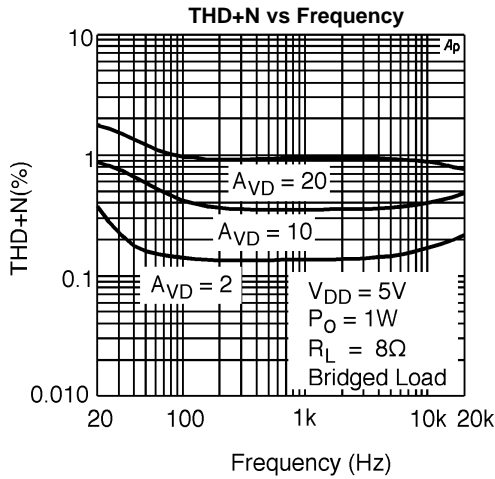

Figure 12.

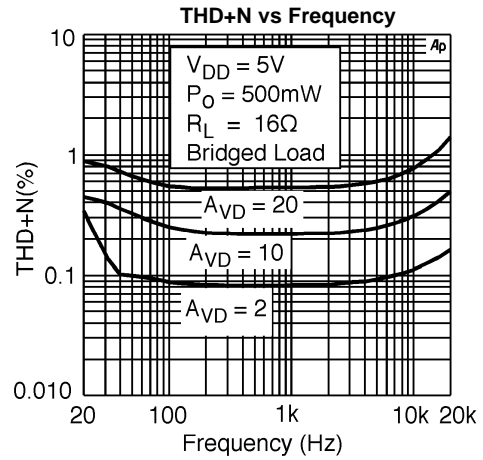

Figure 13.

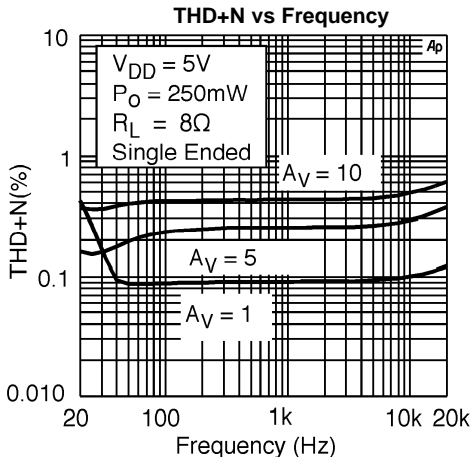

Figure 14.

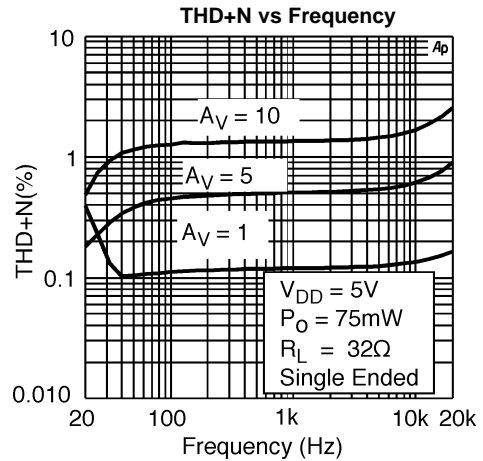

Figure 15.

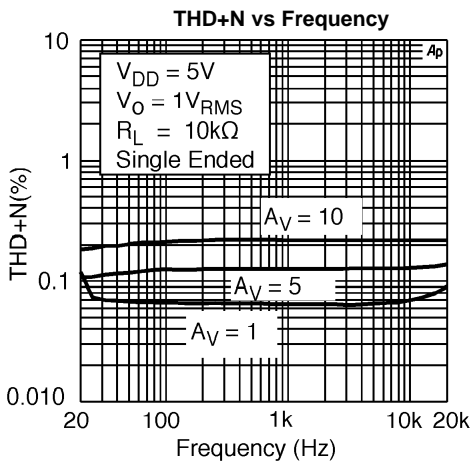

Figure 16.

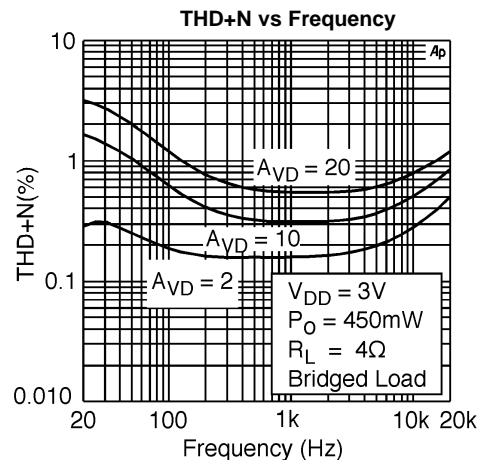
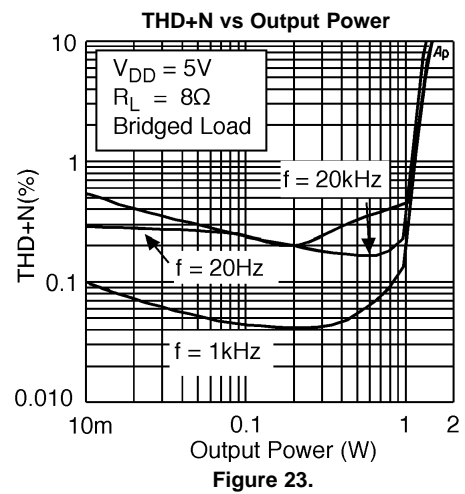
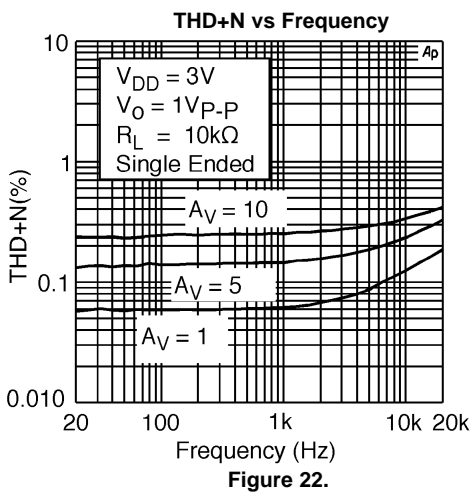
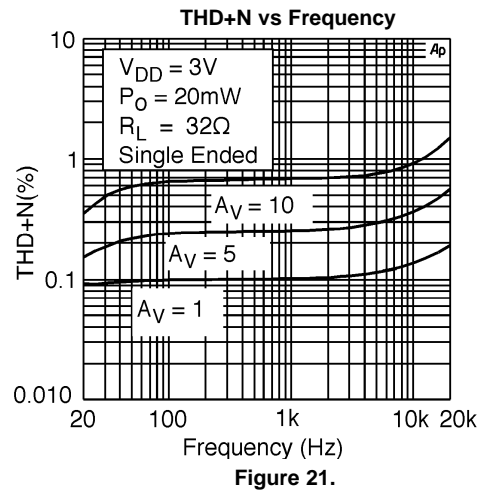
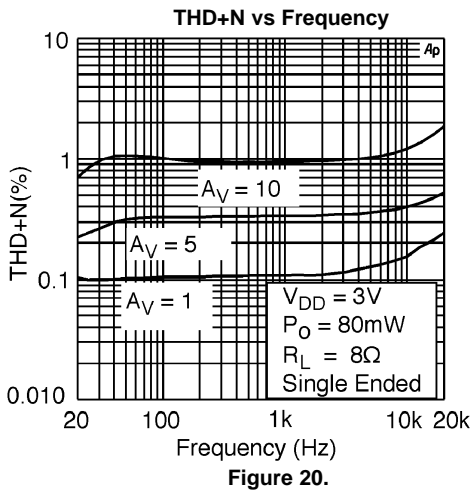
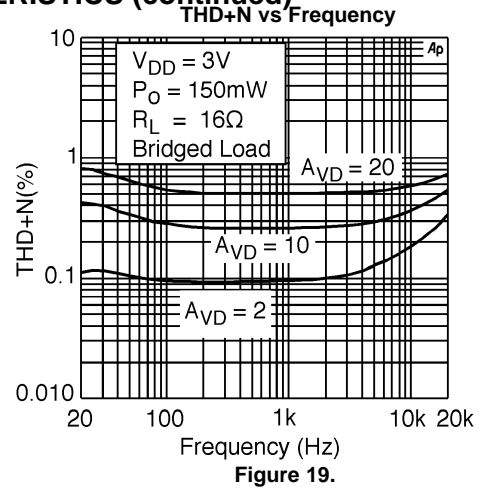
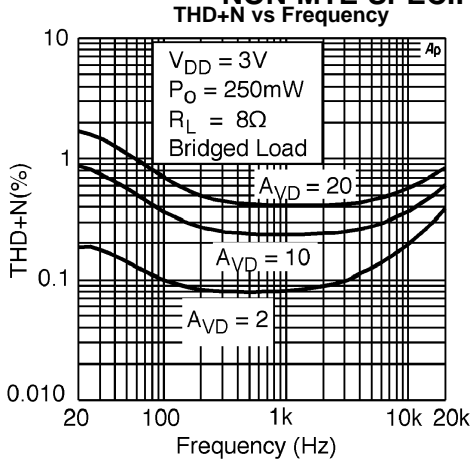

Figure 17.

TYPICAL PERFORMANCE CHARACTERISTICS

NON-MTE SPECIFIC CHARACTERISTICS (continued)



TYPICAL PERFORMANCE CHARACTERISTICS

NON-MTE SPECIFIC CHARACTERISTICS (continued)

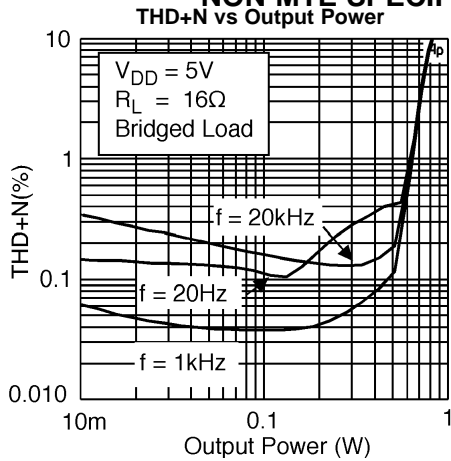

Figure 24.

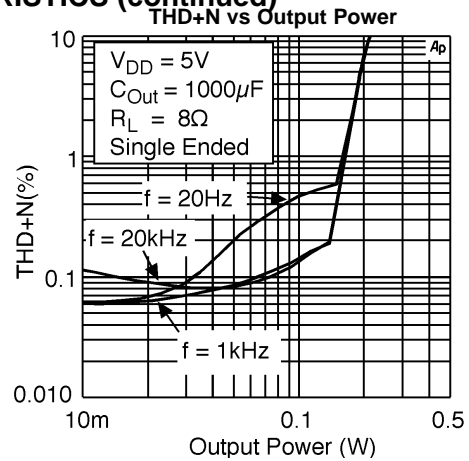

Figure 25.

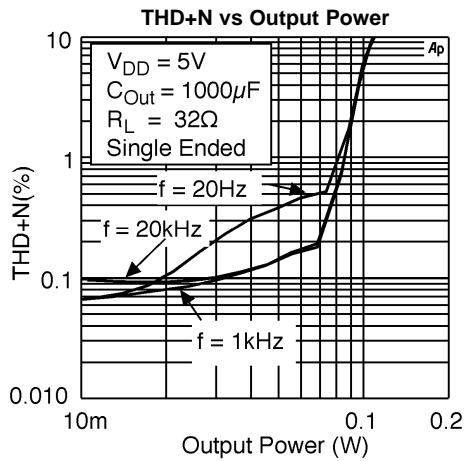

Figure 26.

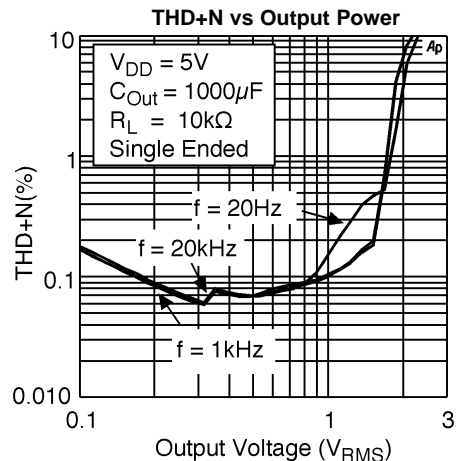

Figure 27.

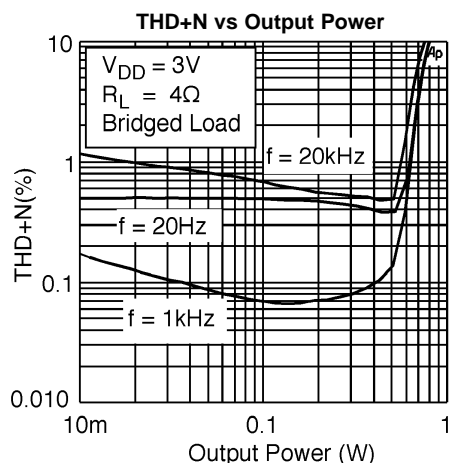

Figure 28.

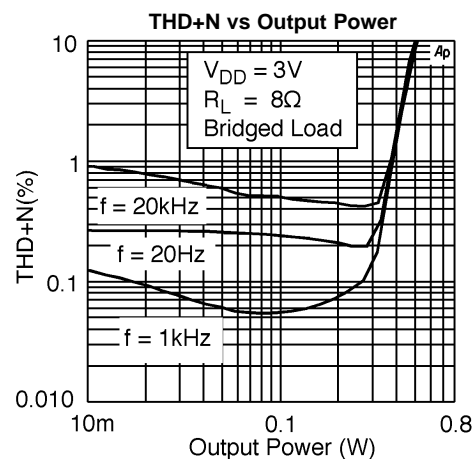

Figure 29.

**TYPICAL PERFORMANCE CHARACTERISTICS**

**NON-MTE SPECIFIC CHARACTERISTICS (continued)**

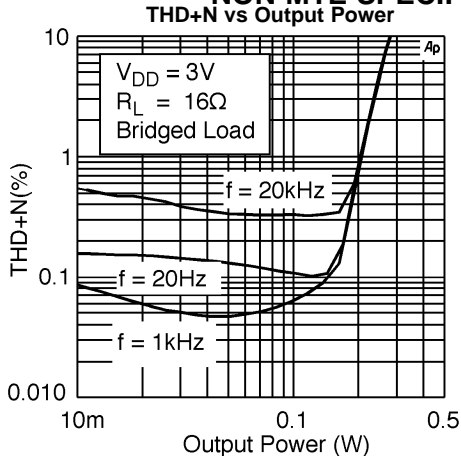

Figure 30.

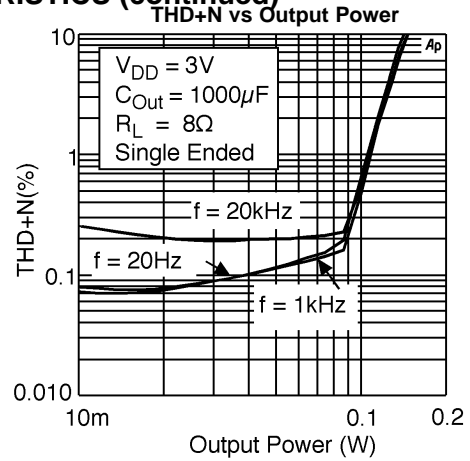

Figure 31.

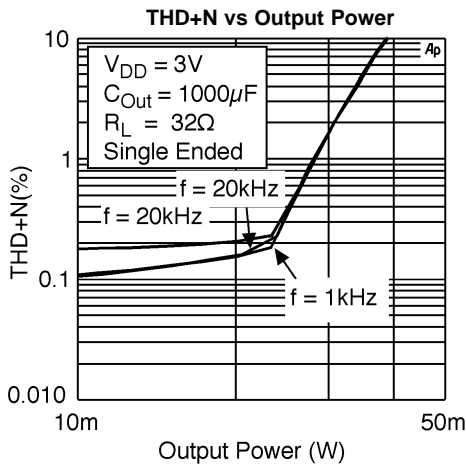

Figure 32.

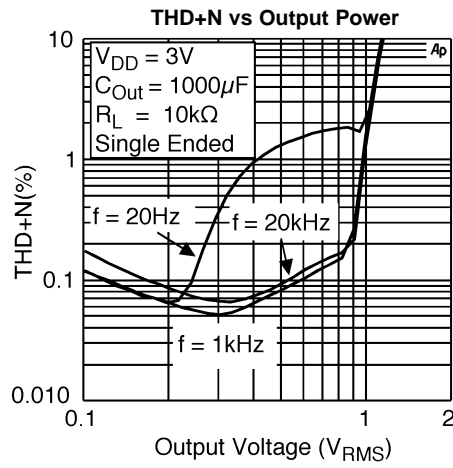

Figure 33.

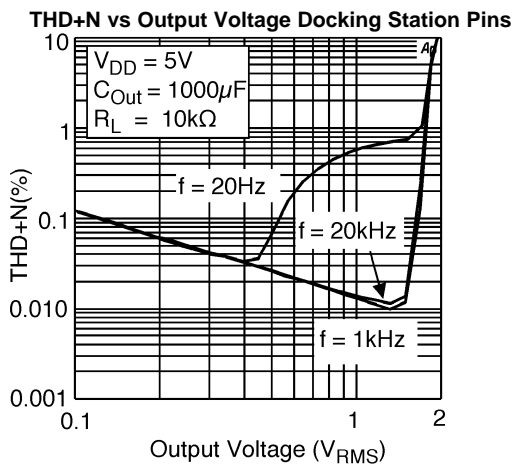

Figure 34.

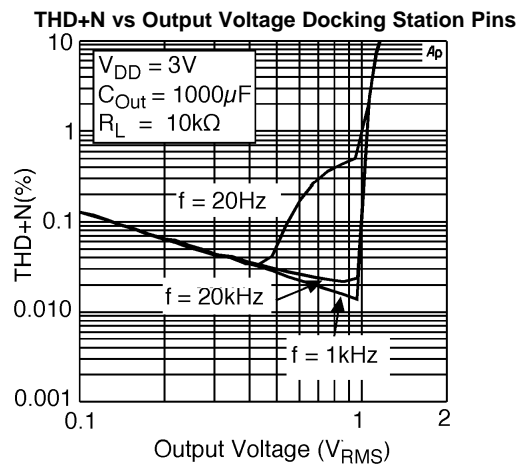

Figure 35.

TYPICAL PERFORMANCE CHARACTERISTICS

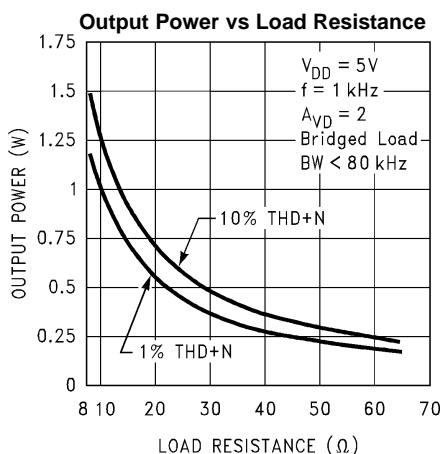

Figure 36.

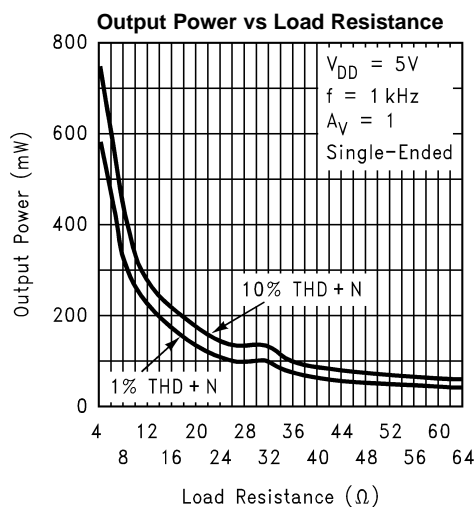

Figure 37.

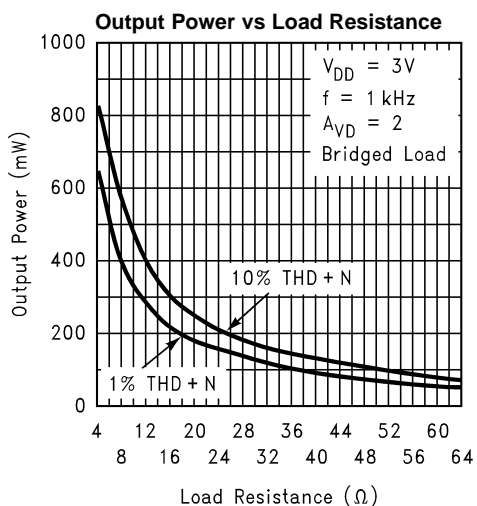

Figure 38.

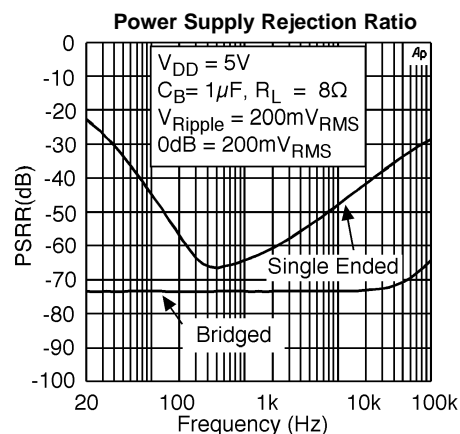

Figure 39.

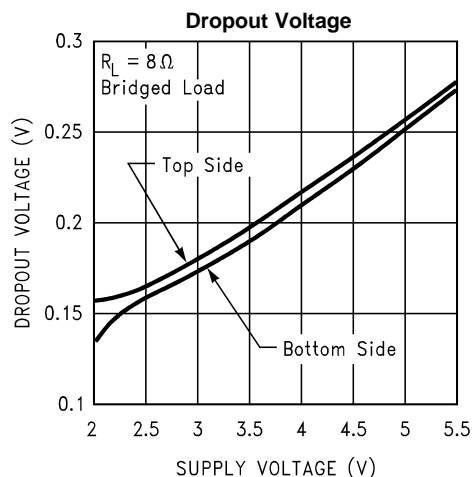

Figure 40.

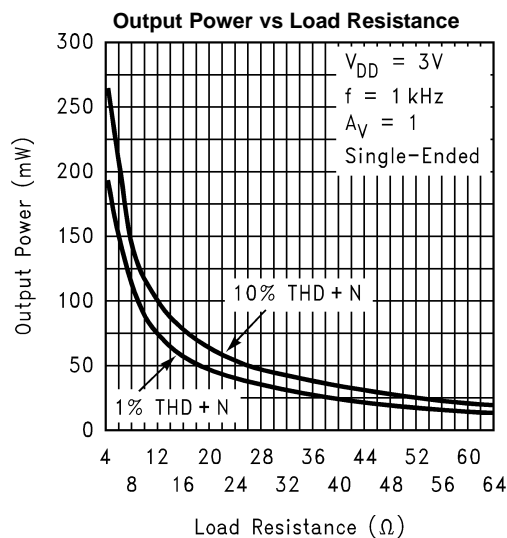

Figure 41.

**TYPICAL PERFORMANCE CHARACTERISTICS (continued)**

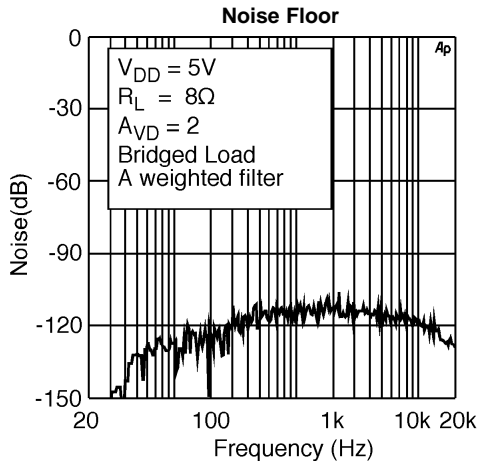

Figure 42.

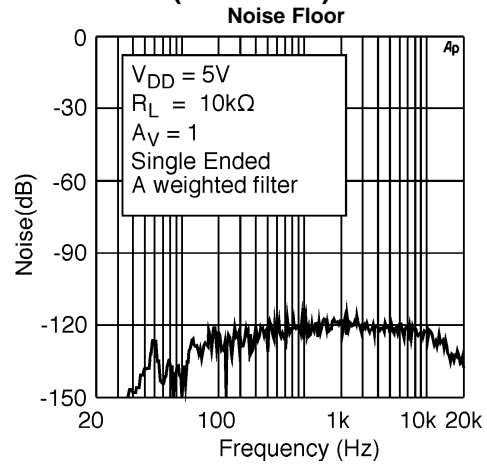

Figure 43.

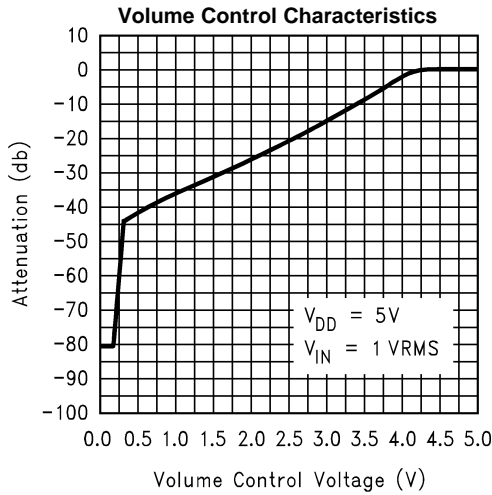

Figure 44.

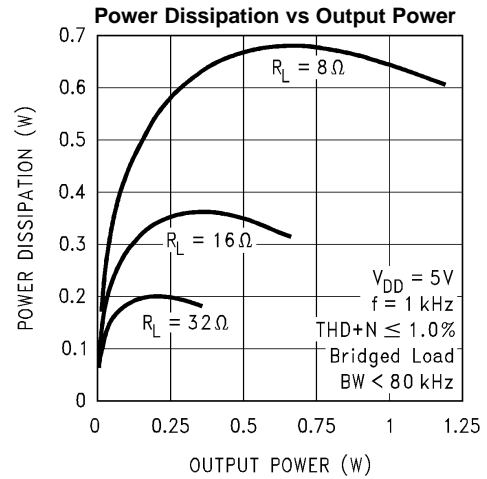

Figure 45.

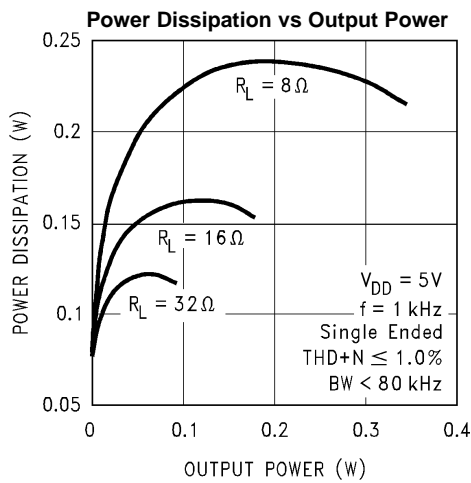

Figure 46.

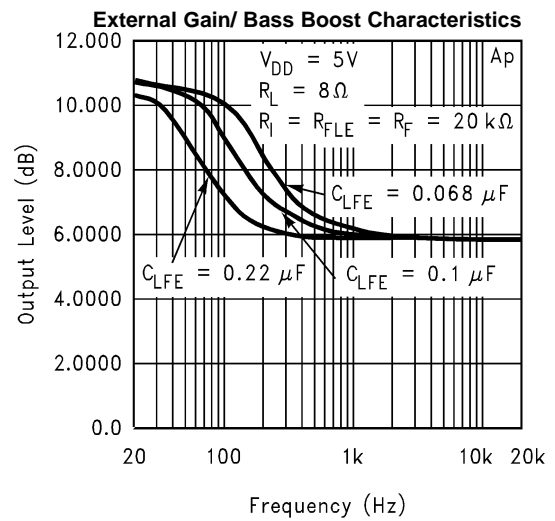

Figure 47.

**TYPICAL PERFORMANCE CHARACTERISTICS (continued)**

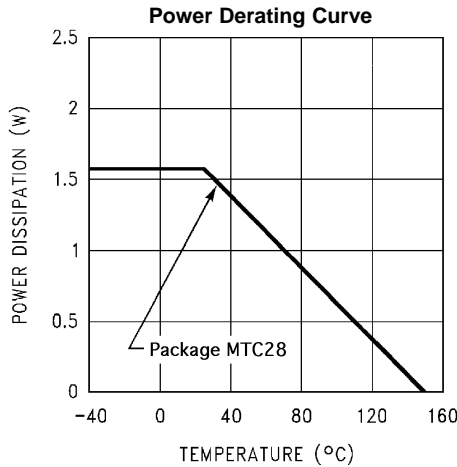

Figure 48.

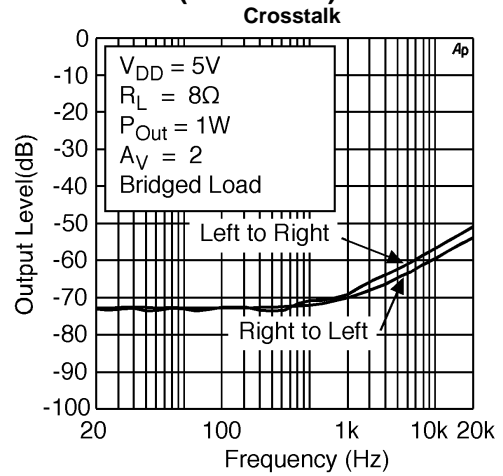

Figure 49.

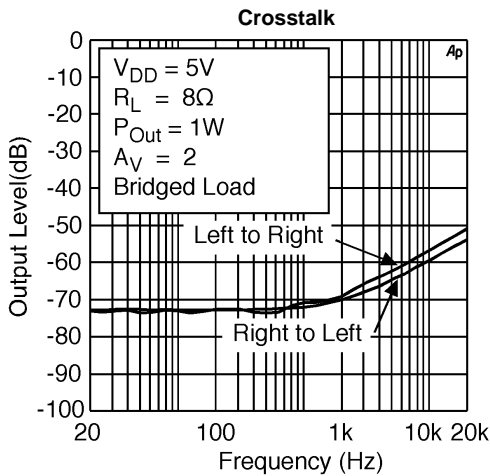

Figure 50.

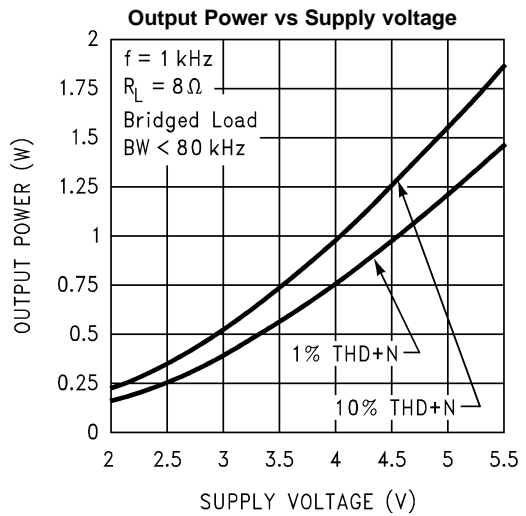

Figure 51.

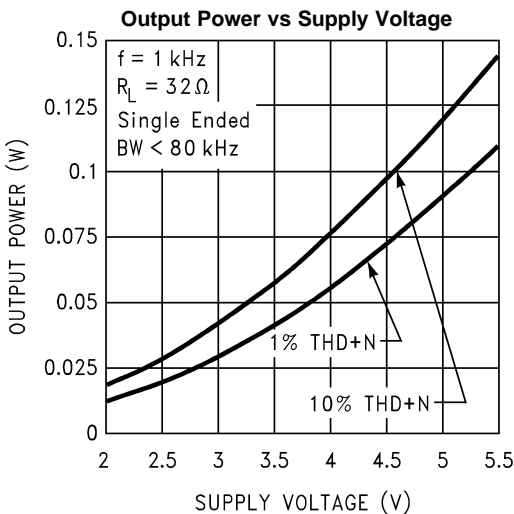

Figure 52.

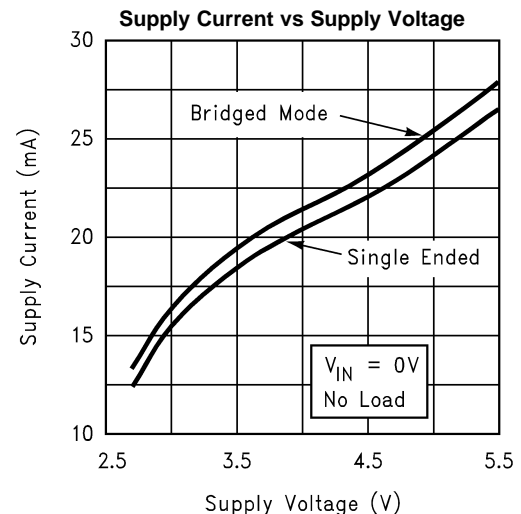

Figure 53.

## APPLICATION INFORMATION

### EXPOSED-DAP PACKAGE PCB MOUNTING CONSIDERATIONS

The LM4835's exposed-DAP (die attach paddle) packages (MTE and LQ) provide a low thermal resistance between the die and the PCB to which the part is mounted and soldered. This allows rapid heat transfer from the die to the surrounding PCB copper traces, ground plane and, finally, surrounding air. The result is a low voltage audio power amplifier that produces 2.1W at  $\leq 1\%$  THD with a  $4\Omega$  load. This high power is achieved through careful consideration of necessary thermal design. Failing to optimize thermal design may compromise the LM4835's high power performance and activate unwanted, though necessary, thermal shutdown protection.

The MTE and LQ packages must have their DAPs soldered to a copper pad on the PCB. The DAP's PCB copper pad is connected to a large plane of continuous unbroken copper. This plane forms a thermal mass and heat sink and radiation area. Place the heat sink area on either outside plane in the case of a two-sided PCB, or on an inner layer of a board with more than two layers. Connect the DAP copper pad to the inner layer or backside copper heat sink area with 32(4x8) (MTE) or 6(3x2) (LQ) vias. The via diameter should be 0.012in–0.013in with a 1.27mm pitch. Ensure efficient thermal conductivity by plating-through and solder-filling the vias.

Best thermal performance is achieved with the largest practical copper heat sink area. If the heatsink and amplifier share the same PCB layer, a nominal 2.5in<sup>2</sup> (min) area is necessary for 5V operation with a  $4\Omega$  load. Heatsink areas not placed on the same PCB layer as the LM4835 should be 5in<sup>2</sup> (min) for the same supply voltage and load resistance. The last two area recommendations apply for 25°C ambient temperature. Increase the area to compensate for ambient temperatures above 25°C. In systems using cooling fans, the LM4835MTE can take advantage of forced air cooling. With an air flow rate of 450 linear-feet per minute and a 2.5in<sup>2</sup> exposed copper or 5.0in<sup>2</sup> inner layer copper plane heatsink, the LM4835MTE can continuously drive a  $3\Omega$  load to full power. The LM4835LQ achieves the same output power level without forced air cooling. In all circumstances and conditions, the junction temperature must be held below 150°C to prevent activating the LM4835's thermal shutdown protection. The LM4835's power de-rating curve in the [Typical Performance Characteristics](#) shows the maximum power dissipation versus temperature. Example PCB layouts for the exposed-DAP TSSOP and LQ packages are shown in the [Demonstration Board Layout](#) section. Further detailed and specific information concerning PCB layout, fabrication, and mounting an LQ (WQFN) package is available in TI's [SNOA401](#).

### PCB LAYOUT AND SUPPLY REGULATION CONSIDERATIONS FOR DRIVING $3\Omega$ AND $4\Omega$ LOADS

Power dissipated by a load is a function of the voltage swing across the load and the load's impedance. As load impedance decreases, load dissipation becomes increasingly dependent on the interconnect (PCB trace and wire) resistance between the amplifier output pins and the load's connections. Residual trace resistance causes a voltage drop, which results in power dissipated in the trace and not in the load as desired. For example, 0.1 $\Omega$  trace resistance reduces the output power dissipated by a  $4\Omega$  load from 2.1W to 2.0W. This problem of decreased load dissipation is exacerbated as load impedance decreases. Therefore, to maintain the highest load dissipation and widest output voltage swing, PCB traces that connect the output pins to a load must be as wide as possible.

Poor power supply regulation adversely affects maximum output power. A poorly regulated supply's output voltage decreases with increasing load current. Reduced supply voltage causes decreased headroom, output signal clipping, and reduced output power. Even with tightly regulated supplies, trace resistance creates the same effects as poor supply regulation. Therefore, making the power supply traces as wide as possible helps maintain full output voltage swing.

### BRIDGE CONFIGURATION EXPLANATION

As shown in [Figure 4](#), the LM4835 consists of two pairs of operational amplifiers, forming a two-channel (channel A and channel B) stereo amplifier. (Though the following discusses channel A, it applies equally to channel B.) External resistors  $R_f$  and  $R_i$  set the closed-loop gain of Amp1A, whereas two internal 20k $\Omega$  resistors set Amp2A's gain at  $-1$ . The LM4835 drives a load, such as a speaker, connected between the two amplifier outputs,  $-OUTA$  and  $+OUTA$ .



Figure 4 shows that Amp1A's output serves as Amp2A's input. This results in both amplifiers producing signals identical in magnitude, but 180° out of phase. Taking advantage of this phase difference, a load is placed between –OUTA and +OUTA and driven differentially (commonly referred to as “bridge mode”). This results in a differential gain of

$$A_{VD} = 2 * (R_f / R_i) \quad (1)$$

Bridge mode amplifiers are different from single-ended amplifiers that drive loads connected between a single amplifier's output and ground. For a given supply voltage, bridge mode has a distinct advantage over the single-ended configuration: its differential output doubles the voltage swing across the load. This produces four times the output power when compared to a single-ended amplifier under the same conditions. This increase in attainable output power assumes that the amplifier is not current limited or that the output signal is not clipped. To ensure minimum output signal clipping when choosing an amplifier's closed-loop gain, refer to the [AUDIO POWER AMPLIFIER DESIGN](#) section.

Another advantage of the differential bridge output is no net DC voltage across the load. This is accomplished by biasing channel A's and channel B's outputs at half-supply. This eliminates the coupling capacitor that single supply, single-ended amplifiers require. Eliminating an output coupling capacitor in a single-ended configuration forces a single-supply amplifier's half-supply bias voltage across the load. This increases internal IC power dissipation and may permanently damage loads such as speakers.

## POWER DISSIPATION

Power dissipation is a major concern when designing a successful single-ended or bridged amplifier. [Equation 2](#) states the maximum power dissipation point for a single-ended amplifier operating at a given supply voltage and driving a specified output load.

$$P_{D_{MAX}} = (V_{DD})^2 / (2\pi^2 R_L) \quad \text{Single-Ended} \quad (2)$$

However, a direct consequence of the increased power delivered to the load by a bridge amplifier is higher internal power dissipation for the same conditions.

The LM4835 has two operational amplifiers per channel. The maximum internal power dissipation per channel operating in the bridge mode is four times that of a single-ended amplifier. From [Equation 3](#), assuming a 5V power supply and a 4Ω load, the maximum single channel power dissipation is 1.27W or 2.54W for stereo operation.

$$P_{D_{MAX}} = 4 * (V_{DD})^2 / (2\pi^2 R_L) \quad \text{Bridge Mode} \quad (3)$$

The LM4835's power dissipation is twice that given by [Equation 2](#) or [Equation 3](#) when operating in the single-ended mode or bridge mode, respectively. Twice the maximum power dissipation point given by [Equation 3](#) must not exceed the power dissipation given by [Equation 4](#):

$$P_{D_{MAX}'} = (T_{J_{MAX}} - T_A) / \theta_{JA} \quad (4)$$

The LM4835's  $T_{J_{MAX}} = 150^\circ\text{C}$ . In the LQ package soldered to a DAP pad that expands to a copper area of 5in<sup>2</sup> on a PCB, the LM4835's  $\theta_{JA}$  is 20°C/W. In the MTE package soldered to a DAP pad that expands to a copper area of 2in<sup>2</sup> on a PCB, the LM4835's  $\theta_{JA}$  is 41°C/W. At any given ambient temperature  $T_A$ , use [Equation 4](#) to find the maximum internal power dissipation supported by the IC packaging. Rearranging [Equation 4](#) and substituting  $P_{D_{MAX}}$  for  $P_{D_{MAX}'}$  results in [Equation 5](#). This equation gives the maximum ambient temperature that still allows maximum stereo power dissipation without violating the LM4835's maximum junction temperature.

$$T_A = T_{J_{MAX}} - 2 * P_{D_{MAX}} \theta_{JA} \quad (5)$$

For a typical application with a 5V power supply and an 4Ω load, the maximum ambient temperature that allows maximum stereo power dissipation without exceeding the maximum junction temperature is approximately 99°C for the LQ package and 45°C for the MTE package.

$$T_{J_{MAX}} = P_{D_{MAX}} \theta_{JA} + T_A \quad (6)$$

[Equation 6](#) gives the maximum junction temperature  $T_{J_{MAX}}$ . If the result violates the LM4835's 150°C, reduce the maximum junction temperature by reducing the power supply voltage or increasing the load resistance. Further allowance should be made for increased ambient temperatures.

The above examples assume that a device is a surface mount part operating around the maximum power dissipation point. Since internal power dissipation is a function of output power, higher ambient temperatures are allowed as output power or duty cycle decreases.

If the result of [Equation 3](#) is greater than that of [Equation 4](#), then decrease the supply voltage, increase the load impedance, or reduce the ambient temperature. If these measures are insufficient, a heat sink can be added to reduce  $\theta_{JA}$ . The heat sink can be created using additional copper area around the package, with connections to the ground pin(s), supply pin and amplifier output pins. External, solder attached SMT heatsinks such as the Thermalloy 7106D can also improve power dissipation. When adding a heat sink, the  $\theta_{JA}$  is the sum of  $\theta_{JC}$ ,  $\theta_{CS}$ , and  $\theta_{SA}$ . ( $\theta_{JC}$  is the junction-to-case thermal impedance,  $\theta_{CS}$  is the case-to-sink thermal impedance, and  $\theta_{SA}$  is the sink-to-ambient thermal impedance.) Refer to the [Typical Performance Characteristics](#) curves for power dissipation information at lower output power levels.

## POWER SUPPLY BYPASSING

As with any power amplifier, proper supply bypassing is critical for low noise performance and high power supply rejection. Applications that employ a 5V regulator typically use a 10 $\mu$ F in parallel with a 0.1 $\mu$ F filter capacitors to stabilize the regulator's output, reduce noise on the supply line, and improve the supply's transient response. However, their presence does not eliminate the need for a local 1.0 $\mu$ F tantalum bypass capacitance connected between the LM4835's supply pins and ground. Do not substitute a ceramic capacitor for the tantalum. Doing so may cause oscillation. Keep the length of leads and traces that connect capacitors between the LM4835's power supply pin and ground as short as possible. Connecting a 1 $\mu$ F capacitor,  $C_B$ , between the BYPASS pin and ground improves the internal bias voltage's stability and improves the amplifier's PSRR. The PSRR improvements increase as the bypass pin capacitor value increases. Too large, however, increases turn-on time and can compromise amplifier's click and pop performance. The selection of bypass capacitor values, especially  $C_B$ , depends on desired PSRR requirements, click and pop performance (as explained in the section, [SELECTING PROPER EXTERNAL COMPONENTS](#)), system cost, and size constraints.

## SELECTING PROPER EXTERNAL COMPONENTS

Optimizing the LM4835's performance requires properly selecting external components. Though the LM4835 operates well when using external components with wide tolerances, best performance is achieved by optimizing component values.

The LM4835 is unity-gain stable, giving a designer maximum design flexibility. The gain should be set to no more than a given application requires. This allows the amplifier to achieve minimum THD+N and maximum signal-to-noise ratio. These parameters are compromised as the closed-loop gain increases. However, low gain demands input signals with greater voltage swings to achieve maximum output power. Fortunately, many signal sources such as audio CODECs have outputs of  $1V_{RMS}$  (2.83V<sub>P-P</sub>). Please refer to the [AUDIO POWER AMPLIFIER DESIGN](#) section for more information on selecting the proper gain.

## INPUT CAPACITOR VALUE SELECTION

Amplifying the lowest audio frequencies requires high value input coupling capacitor (0.33 $\mu$ F in [Figure 4](#)). A high value capacitor can be expensive and may compromise space efficiency in portable designs. In many cases, however, the speakers used in portable systems, whether internal or external, have little ability to reproduce signals below 150 Hz. Applications using speakers with this limited frequency response reap little improvement by using large input capacitor.

Besides effecting system cost and size, the input coupling capacitor has an affect on the LM4835's click and pop performance. When the supply voltage is first applied, a transient (pop) is created as the charge on the input capacitor changes from zero to a quiescent state. The magnitude of the pop is directly proportional to the input capacitor's size. Higher value capacitors need more time to reach a quiescent DC voltage (usually  $V_{DD}/2$ ) when charged with a fixed current. The amplifier's output charges the input capacitor through the feedback resistor,  $R_f$ . Thus, pops can be minimized by selecting an input capacitor value that is no higher than necessary to meet the desired -3dB frequency.

As shown in [Figure 4](#), the input resistor (20k $\Omega$ ) and the input capacitor produce a -3dB high pass filter cutoff frequency that is found using [Equation 7](#).

$$f_{-3\text{ dB}} = \frac{1}{2\pi R_{IN} C_1} \quad (7)$$

As an example when using a speaker with a low frequency limit of 150Hz, the input coupling capacitor, using [Equation 7](#), is 0.063 $\mu$ F. The 0.33 $\mu$ F input coupling capacitor shown in [Figure 4](#) allows the LM4835 to drive high efficiency, full range speaker whose response extends below 30Hz.

## OPTIMIZING CLICK AND POP REDUCTION PERFORMANCE

The LM4835 contains circuitry that minimizes turn-on and shutdown transients or “clicks and pop”. For this discussion, turn-on refers to either applying the power supply voltage or when the shutdown mode is deactivated. While the power supply is ramping to its final value, the LM4835’s internal amplifiers are configured as unity gain buffers. An internal current source changes the voltage of the BYPASS pin in a controlled, linear manner. Ideally, the input and outputs track the voltage applied to the BYPASS pin. The gain of the internal amplifiers remains unity until the voltage on the bypass pin reaches  $1/2 V_{DD}$ . As soon as the voltage on the bypass pin is stable, the device becomes fully operational. Although the BYPASS pin current cannot be modified, changing the size of  $C_B$  alters the device’s turn-on time and the magnitude of “clicks and pops”. Increasing the value of  $C_B$  reduces the magnitude of turn-on pops. However, this presents a tradeoff: as the size of  $C_B$  increases, the turn-on time increases. There is a linear relationship between the size of  $C_B$  and the turn-on time. Here are some typical turn-on times for various values of  $C_B$ :

$C_B$	$T_{ON}$
0.01 $\mu$ F	2ms
0.1 $\mu$ F	20ms
0.22 $\mu$ F	44ms
0.47 $\mu$ F	94ms
1.0 $\mu$ F	200ms

In order eliminate “clicks and pops”, all capacitors must be discharged before turn-on. Rapidly switching  $V_{DD}$  may not allow the capacitors to fully discharge, which may cause “clicks and pops”. In a single-ended configuration, the output is coupled to the load by  $C_{OUT}$ . This capacitor usually has a high value.  $C_{OUT}$  discharges through internal 20k $\Omega$  resistors. Depending on the size of  $C_{OUT}$ , the discharge time constant can be relatively large. To reduce transients in single-ended mode, an external 1k $\Omega$ –5k $\Omega$  resistor can be placed in parallel with the internal 20k $\Omega$  resistor. The tradeoff for using this resistor is increased quiescent current.

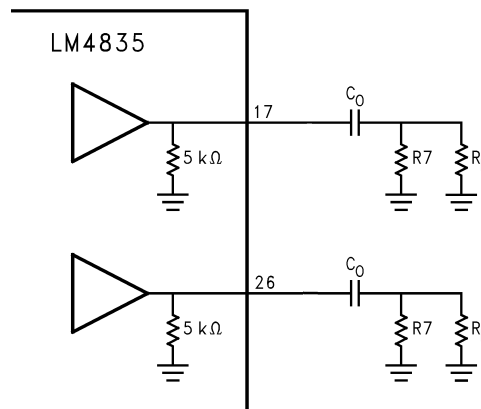

Figure 54. Resistor for Varying Output Loads

## DOCKING STATION INTERFACE

Applications such as notebook computers can take advantage of a docking station to connect to external devices such as monitors or audio/visual equipment that sends or receives line level signals. The LM4835 has two outputs, Pin 9 and Pin 13, which connect to outputs of the internal input amplifiers that drive the volume control inputs. These input amplifiers can drive loads of  $>1k\Omega$  (such as powered speakers) with a rail-to-rail signal. Since the output signal present on the RIGHT DOCK and LEFT DOCK pins is biased to  $V_{DD}/2$ , coupling capacitors should be connected in series with the load. Typical values for the coupling capacitors are 0.33 $\mu$ F to 1.0 $\mu$ F. If polarized coupling capacitors are used, connect their “+” terminals to the respective output pin.

Since the DOCK outputs precede the internal volume control, the signal amplitude will be equal to the input signal’s magnitude and cannot be adjusted. However, the input amplifier’s closed-loop gain can be adjusted using external resistors. These resistors are shown in Figure 4 as 20k $\Omega$  devices that set each input amplifier’s gain to -1. Use Equation 8 to determine the input and feedback resistor values for a desired gain.

$$-A_v = R_F / R_i \tag{8}$$

Adjusting the input amplifier's gain sets the minimum gain for that channel. The DOCK outputs adds circuit and functional flexibility because their use supercedes using the inverting outputs of each bridged output amplifier as line-level outputs.

## BEEP DETECT FUNCTION

Computers and notebooks produce a system “beep” signal that drives a small speaker. The speaker's auditory output signifies that the system requires user attention or input. To accommodate this system alert signal, the LM4835's pin 11 is a mono input that accepts the beep signal. Internal level detection circuitry at this input monitors the beep signal's magnitude. When a signal level greater than  $V_{DD}/2$  is detected on pin 11, the bridge output amplifiers are enabled. The beep signal is amplified and applied to the load connected to the output amplifiers. A valid beep signal will be applied to the load even when MUTE is active. Use the input resistors connected between the BEEP IN pin and the stereo input pins to accommodate different beep signal amplitudes. These resistors are shown as 200k $\Omega$  devices in [Figure 4](#). Use higher value resistors to reduce the gain applied to the beep signal. The resistors must be used to pass the beep signal to the stereo inputs. The BEEP IN pin is used only to detect the beep signal's magnitude: it does not pass the signal to the output amplifiers. The LM4835's shutdown mode must be deactivated before a system alert signal is applied to BEEP IN pin.

## MICRO-POWER SHUTDOWN

The voltage applied to the SHUTDOWN pin controls the LM4835's shutdown function. Activate micro-power shutdown by applying  $V_{DD}$  to the SHUTDOWN pin. When active, the LM4835's micro-power shutdown feature turns off the amplifier's bias circuitry, reducing the supply current. The logic threshold is typically  $V_{DD}/2$ . The low 0.7 $\mu$ A typical shutdown current is achieved by applying a voltage that is as near as  $V_{DD}$  as possible to the SHUTDOWN pin. A voltage that is less than  $V_{DD}$  may increase the shutdown current. [Table 1](#) shows the logic signal levels that activate and deactivate micro-power shutdown and headphone amplifier operation.

There are a few ways to control the micro-power shutdown. These include using a single-pole, single-throw switch, a microprocessor, or a microcontroller. When using a switch, connect an external 10k $\Omega$  pull-up resistor between the SHUTDOWN pin and  $V_{DD}$ . Connect the switch between the SHUTDOWN pin and ground. Select normal amplifier operation by closing the switch. Opening the switch connects the SHUTDOWN pin to  $V_{DD}$  through the pull-up resistor, activating micro-power shutdown. The switch and resistor ensure that the SHUTDOWN pin will not float. This prevents unwanted state changes. In a system with a microprocessor or a microcontroller, use a digital output to apply the control voltage to the SHUTDOWN pin. Driving the SHUTDOWN pin with active circuitry eliminates the pull up resistor.

**Table 1. LOGIC LEVEL TRUTH TABLE FOR SHUTDOWN, HP-IN, AND MUX OPERATION**

SHUTDOWN PIN	HP-IN PIN	MUX CHANNEL SELECT PIN	OPERATIONAL MODE (MUX INPUT CHANNEL #)
Logic Low	Logic Low	Logic Low	Bridged Amplifiers (1)
Logic Low	Logic Low	Logic High	Bridged Amplifiers (2)
Logic Low	Logic High	Logic Low	Single-Ended Amplifiers (1)
Logic Low	Logic High	Logic High	Single-Ended Amplifiers (2)
Logic High	X	X	Micro-Power Shutdown

## MODE FUNCTION

The LM4835's MODE function has two states controlled by the voltage applied to the MODE pin (pin 4). Mode 0, selected by applying 0V to the MODE pin, forces the LM4835 to effectively function as a "line-out," unity-gain amplifier. Mode 1, which uses the internal DC controlled volume control, is selected by applying  $V_{DD}$  to the MODE pin. This mode sets the amplifier's gain according to the DC voltage applied to the DC VOL CONTROL pin. Prevent unanticipated gain behavior by connecting the MODE pin to  $V_{DD}$  or ground. Do not let pin 4 float.

## MUTE FUNCTION

The LM4835 mutes the amplifier and DOCK outputs when  $V_{DD}$  is applied to pin 5, the MUTE pin. Even while muted, the LM4835 will amplify a system alert (beep) signal whose magnitude satisfies the BEEP DETECT circuitry. Applying 0V to the MUTE pin returns the LM4835 to normal, unmuted operation. Prevent unanticipated mute behavior by connecting the MUTE pin to  $V_{DD}$  or ground. Do not let pin 5 float.

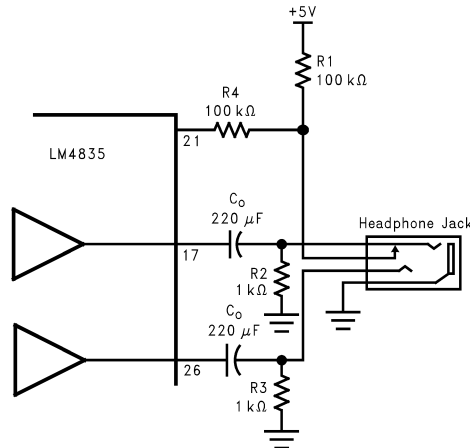

Figure 55. Headphone Sensing Circuit

## HP-IN FUNCTION

Applying a voltage between 4V and  $V_{DD}$  to the LM4835's HP-IN headphone control pin turns off Amp2A and Amp2B, muting a bridged-connected load. Quiescent current consumption is reduced when the IC is in this single-ended mode.

Figure 55 shows the implementation of the LM4835's headphone control function. With no headphones connected to the headphone jack, the R1-R2 voltage divider sets the voltage applied to the HP-IN pin (pin 16) at approximately 50mV. This 50mV enables Amp1B and Amp2B, placing the LM4835 in bridged mode operation. The output coupling capacitor blocks the amplifier's half supply DC voltage, protecting the headphones.

The HP-IN threshold is set at 4V. While the LM4835 operates in bridged mode, the DC potential across the load is essentially 0V. Therefore, even in an ideal situation, the output swing cannot cause a false single-ended trigger. Connecting headphones to the headphone jack disconnects the headphone jack contact pin from  $-OUTA$  and allows R1 to pull the HP Sense pin up to  $V_{DD}$ . This enables the headphone function, turns off Amp2A and Amp2B, and mutes the bridged speaker. The amplifier then drives the headphones, whose impedance is in parallel with resistor R2 and R3. These resistors have negligible effect on the LM4835's output drive capability since the typical impedance of headphones is 32Ω.

Figure 55 also shows the suggested headphone jack electrical connections. The jack is designed to mate with a three-wire plug. The plug's tip and ring should each carry one of the two stereo output signals, whereas the sleeve should carry the ground return. A headphone jack with one control pin contact is sufficient to drive the HP-IN pin when connecting headphones.

A microprocessor or a switch can replace the headphone jack contact pin. When a microprocessor or switch applies a voltage greater than 4V to the HP-IN pin, a bridge-connected speaker is muted and Amp1A and Amp2A drive a pair of headphones.

## GAIN SELECT FUNCTION (Bass Boost)

The LM4835 features selectable gain, using either internal and external feedback resistors. Either set of feedback resistors set the gain of the output amplifiers. The voltage applied to pin 3 (GAIN SELECT pin) controls which gain is selected. Applying  $V_{DD}$  to the GAIN SELECT pin selects the external gain mode. Applying 0V to the GAIN SELECT pin selects the internally set unity gain.

In some cases a designer may want to improve the low frequency response of the bridged amplifier or incorporate a bass boost feature. This bass boost can be useful in systems where speakers are housed in small enclosures. A resistor,  $R_{LFE}$ , and a capacitor,  $C_{LFE}$ , in parallel, can be placed in series with the feedback resistor of the bridged amplifier as seen in Figure 56.

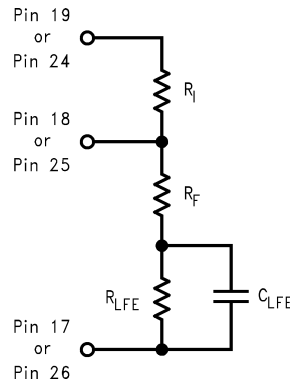

At low frequencies  $C_{LFE}$  is a virtual open circuit and at high frequencies, its nearly zero ohm impedance shorts  $R_{LFE}$ . The result is increased bridge-amplifier gain at low frequencies. The combination of  $R_{LFE}$  and  $C_{LFE}$  form with a -3dB corner frequency at

**Figure 56. Low Frequency Enhancement**

$$f_c = 1 / (2\pi R_{LFE} C_{LFE}) \quad (9)$$

The bridged-amplifier low frequency differential gain is:

$$A_{VD} = 2(R_F + R_{LFE}) / R_i \quad (10)$$

Using the component values shown in [Figure 4](#) ( $R_F = 20k\Omega$ ,  $R_{LFE} = 20k\Omega$ , and  $C_{LFE} = 0.068\mu F$ ), a first-order, -3dB pole is created at 120Hz. Assuming  $R_i = 20k\Omega$ , the low frequency differential gain is 4. The input ( $C_i$ ) and output ( $C_o$ ) capacitor values must be selected for a low frequency response that covers the range of frequencies affected by the desired bass-boost operation.

## DC VOLUME CONTROL

The LM4835 has an internal stereo volume control whose setting is a function of the DC voltage applied to the DC VOL CONTROL pin. The volume control's voltage input range is 0V to  $V_{DD}$ . The volume range is from 0dB (DC control voltage = 80%  $V_{DD}$ ) to -80dB (DC control voltage = 0V). The volume remains at 0dB for DC control voltages greater than 80%  $V_{DD}$ . When the MODE input is 0V, the LM4835 operates at unity gain, bypassing the volume control. A graph showing a typical volume response versus DC control voltage is shown in the [Typical Performance Characteristics](#) section.

Like all volume controls, the LM4835's internal volume control is set while listening to an amplified signal that is applied to an external speaker. The actual voltage applied to the DC VOL CONTROL pin is a result of the volume a listener desires. As such, the volume control is designed for use in a feedback system that includes human ears and preferences. This feedback system operates quite well without the need for accurate gain. The user simply sets the volume to the desired level as determined by their ear, without regard to the actual DC voltage that produces the volume. Therefore, the accuracy of the volume control is not critical, as long as the volume changes monotonically, matches well between stereo channels, and the step size is small enough to reach a desired volume that is not too loud or too soft. Since gain accuracy is not critical, there will be volume variation from part-to-part even with the same applied DC control voltage. The gain of a given LM4835 can be set with a fixed external voltage, but another LM4835 may require a different control voltage to achieve the same gain. The typical part-to-part variation can be as large as 8dB for the same control voltage.

## AUDIO POWER AMPLIFIER DESIGN

### Audio Amplifier Design: Driving 1W into an 8Ω Load

The following are the desired operational parameters:

**Power Output:** 1 W<sub>RMS</sub>

**Load Impedance:** 8Ω

**Input Level:** 1 V<sub>RMS</sub>

**Input Impedance:** 20 kΩ

**Bandwidth:** 100 Hz–20 kHz ± 0.25 dB

The design begins by specifying the minimum supply voltage necessary to obtain the specified output power. One way to find the minimum supply voltage is to use the Output Power vs Supply Voltage curve in the [Typical Performance Characteristics](#) section. Another way, using [Equation 10](#), is to calculate the peak output voltage necessary to achieve the desired output power for a given load impedance. To account for the amplifier's dropout voltage, two additional voltages, based on the Dropout Voltage vs Supply Voltage in the [Typical Performance Characteristics](#) curves, must be added to the result obtained by [Equation 11](#). The result is [Equation 12](#).

$$V_{\text{outpeak}} = \sqrt{(2R_L P_O)} \quad (11)$$

$$V_{DD} \geq (V_{\text{OUTPEAK}} + (V_{\text{ODTOP}} + V_{\text{ODBOT}})) \quad (12)$$

The Output Power vs Supply Voltage graph for an 8Ω load indicates a minimum supply voltage of 4.6V. This is easily met by the commonly used 5V supply voltage. The additional voltage creates the benefit of headroom, allowing the LM4835 to produce peak output power in excess of 1W without clipping or other audible distortion. The choice of supply voltage must also not create a situation that violates of maximum power dissipation as explained above in the [POWER DISSIPATION](#) section.

After satisfying the LM4835's power dissipation requirements, the minimum differential gain needed to achieve 1W dissipation in an 8Ω load is found using [Equation 13](#).

$$A_{VD} \geq \sqrt{(P_O R_L)} / (V_{IN}) = V_{\text{orms}} / V_{\text{inrms}} \quad (13)$$

Thus, a minimum gain of 2.83 allows the LM4835's to reach full output swing and maintain low noise and THD+N performance. For this example, let  $A_{VD} = 3$ .

The amplifier's overall gain is set using the input ( $R_i$ ) and feedback ( $R_f$ ) resistors. With the desired input impedance set at 20kΩ, the feedback resistor is found using [Equation 14](#).

$$R_f / R_i = A_{VD} / 2 \quad (14)$$

The value of  $R_f$  is 30kΩ.

The last step in this design example is setting the amplifier's -3dB frequency bandwidth. To achieve the desired ±0.25dB pass band magnitude variation limit, the low frequency response must extend to at least one-fifth the lower bandwidth limit and the high frequency response must extend to at least five times the upper bandwidth limit. The gain variation for both response limits is 0.17dB, well within the ±0.25dB desired limit. The results are an

$$f_L = 100\text{Hz} / 5 = 20\text{Hz} \quad (15)$$

and an

$$f_H = 20\text{kHz} \times 5 = 100\text{kHz} \quad (16)$$

As mentioned in the [Selecting Proper External Components](#) section,  $R_i$  and  $C_i$  create a highpass filter that sets the amplifier's lower bandpass frequency limit. Find the input coupling capacitor's value using [Equation 17](#).

$$C_i \geq 1 / (2\pi R_i f_L) \quad (17)$$

The result is

$$1 / (2\pi * 20\text{k}\Omega * 20\text{Hz}) = 0.397\mu\text{F} \quad (18)$$

Use a 0.39μF capacitor, the closest standard value.

The product of the desired high frequency cutoff (100kHz in this example) and the differential gain  $A_{VD}$ , determines the upper passband response limit. With  $A_{VD} = 3$  and  $f_H = 100\text{kHz}$ , the closed-loop gain bandwidth product (GBWP) is 300kHz. This is less than the LM4835's 3.5MHz GBWP. With this margin, the amplifier can be used in designs that require more differential gain while avoiding performance, restricting bandwidth limitations.

## RECOMMENDED PRINTED CIRCUIT BOARD LAYOUT

Figure 57 through Figure 61 show the recommended four-layer PC board layout that is optimized for the 24-pin LQ-packaged LM4835 and associated external components. This circuit is designed for use with an external 5V supply and 4Ω speakers.

This circuit board is easy to use. Apply 5V and ground to the board's  $V_{DD}$  and GND pads, respectively. Connect 4Ω speakers between the board's -OUTA and +OUTA and OUTB and +OUTB pads.

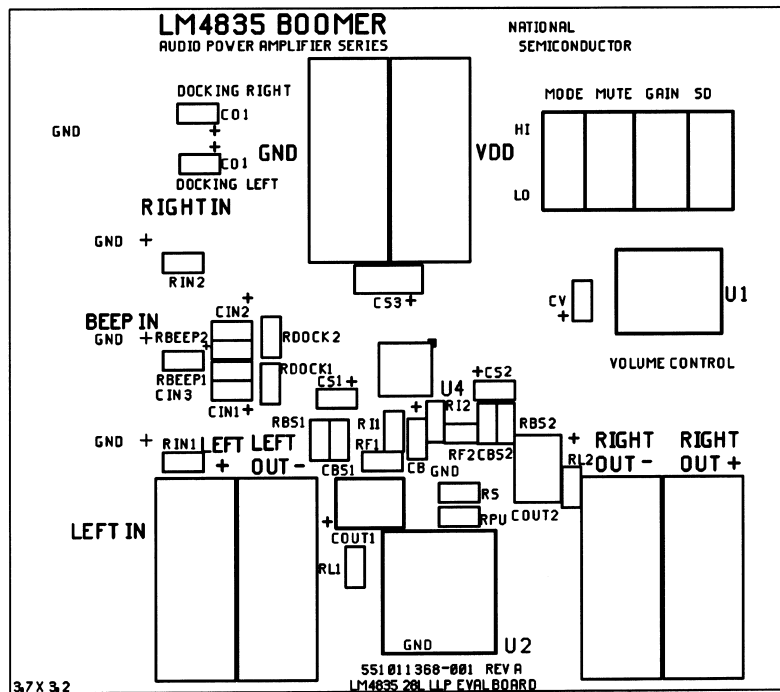

Figure 57. Recommended LQ PC Board Layout: Component-Side Silkscreen



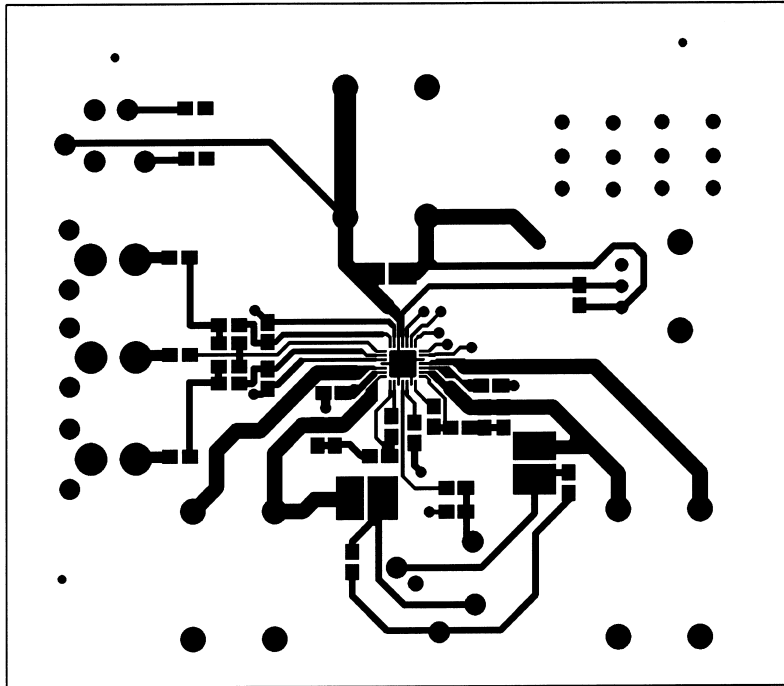

Figure 58. Recommended LQ PC Board Layout: Component-Side Layout

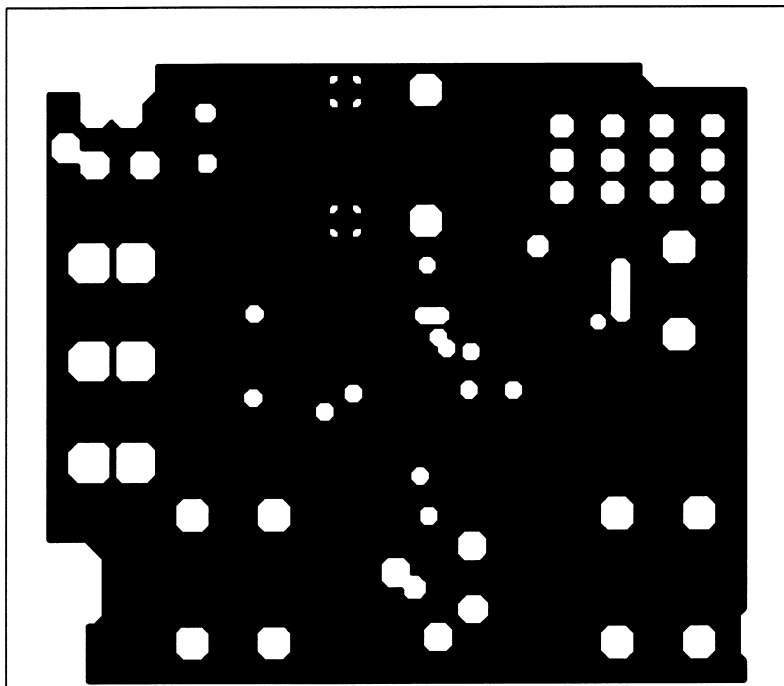

Figure 59. Recommended LQ PC Board Layout: Upper Inner-Layer Layout

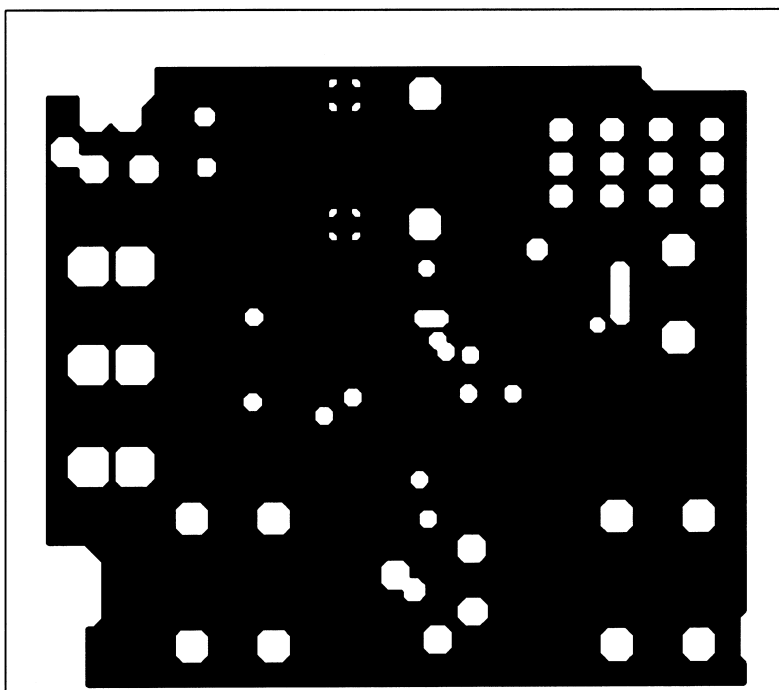

Figure 60. Recommended LQ PC Board Layout: Lower Inner-Layer Layout

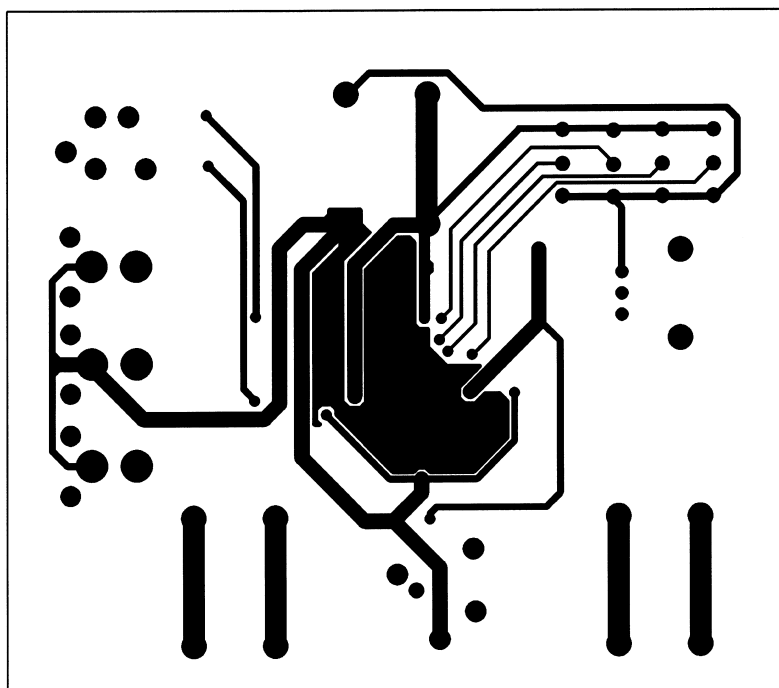
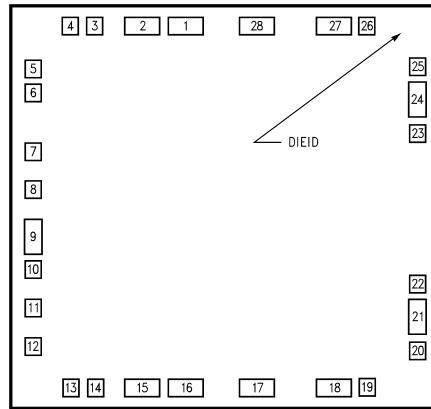

Figure 61. Recommended LQ PC Board Layout: Bottom-Side Layout

**LM4835 MDC MWC  
STEREO 2W AUDIO POWER AMPLIFIER WITH DC VOLUME CONTROL AND SELECTABLE  
GAIN**



**Figure 62. Die Layout (A - Step)**

### REVISION HISTORY

Changes from Revision E (May 2013) to Revision F	Page
• Changed layout of National Data Sheet to TI format .....	<a href="#">27</a>

**PACKAGING INFORMATION**

Orderable Device	Status (1)	Package Type	Package Drawing	Pins	Package Qty	Eco Plan (2)	Lead finish/ Ball material (6)	MSL Peak Temp (3)	Op Temp (°C)	Device Marking (4/5)	Samples
LM4835MTX/NOPB	ACTIVE	TSSOP	PW	28	2500	RoHS & Green	SN	Level-3-260C-168 HR	-40 to 85	LM4835MT	Samples

(1) The marketing status values are defined as follows:

**ACTIVE:** Product device recommended for new designs.

**LIFEBUY:** TI has announced that the device will be discontinued, and a lifetime-buy period is in effect.

**NRND:** Not recommended for new designs. Device is in production to support existing customers, but TI does not recommend using this part in a new design.

**PREVIEW:** Device has been announced but is not in production. Samples may or may not be available.

**OBSOLETE:** TI has discontinued the production of the device.

(2) **RoHS:** TI defines "RoHS" to mean semiconductor products that are compliant with the current EU RoHS requirements for all 10 RoHS substances, including the requirement that RoHS substance do not exceed 0.1% by weight in homogeneous materials. Where designed to be soldered at high temperatures, "RoHS" products are suitable for use in specified lead-free processes. TI may reference these types of products as "Pb-Free".

**RoHS Exempt:** TI defines "RoHS Exempt" to mean products that contain lead but are compliant with EU RoHS pursuant to a specific EU RoHS exemption.

**Green:** TI defines "Green" to mean the content of Chlorine (Cl) and Bromine (Br) based flame retardants meet JS709B low halogen requirements of <=1000ppm threshold. Antimony trioxide based flame retardants must also meet the <=1000ppm threshold requirement.

(3) MSL, Peak Temp. - The Moisture Sensitivity Level rating according to the JEDEC industry standard classifications, and peak solder temperature.

(4) There may be additional marking, which relates to the logo, the lot trace code information, or the environmental category on the device.

(5) Multiple Device Markings will be inside parentheses. Only one Device Marking contained in parentheses and separated by a "-" will appear on a device. If a line is indented then it is a continuation of the previous line and the two combined represent the entire Device Marking for that device.

(6) Lead finish/Ball material - Orderable Devices may have multiple material finish options. Finish options are separated by a vertical ruled line. Lead finish/Ball material values may wrap to two lines if the finish value exceeds the maximum column width.

**Important Information and Disclaimer:**The information provided on this page represents TI's knowledge and belief as of the date that it is provided. TI bases its knowledge and belief on information provided by third parties, and makes no representation or warranty as to the accuracy of such information. Efforts are underway to better integrate information from third parties. TI has taken and continues to take reasonable steps to provide representative and accurate information but may not have conducted destructive testing or chemical analysis on incoming materials and chemicals. TI and TI suppliers consider certain information to be proprietary, and thus CAS numbers and other limited information may not be available for release.

In no event shall TI's liability arising out of such information exceed the total purchase price of the TI part(s) at issue in this document sold by TI to Customer on an annual basis.

**TAPE AND REEL INFORMATION**

**QUADRANT ASSIGNMENTS FOR PIN 1 ORIENTATION IN TAPE**

\*All dimensions are nominal

Device	Package Type	Package Drawing	Pins	SPQ	Reel Diameter (mm)	Reel Width W1 (mm)	A0 (mm)	B0 (mm)	K0 (mm)	P1 (mm)	W (mm)	Pin1 Quadrant
LM4835MTX/NOPB	TSSOP	PW	28	2500	330.0	16.4	6.95	10.0	1.7	8.0	16.0	Q1

**TAPE AND REEL BOX DIMENSIONS**

\*All dimensions are nominal

Device	Package Type	Package Drawing	Pins	SPQ	Length (mm)	Width (mm)	Height (mm)
LM4835MTX/NOPB	TSSOP	PW	28	2500	356.0	356.0	36.0

PW (R-PDSO-G28)

PLASTIC SMALL OUTLINE



4040064-7/G 02/11

- NOTES:
- A. All linear dimensions are in millimeters. Dimensioning and tolerancing per ASME Y14.5M-1994.
  - B. This drawing is subject to change without notice.
  - C. Body length does not include mold flash, protrusions, or gate burrs. Mold flash, protrusions, or gate burrs shall not exceed 0,15 each side.
  - D. Body width does not include interlead flash. Interlead flash shall not exceed 0,25 each side.
  - E. Falls within JEDEC MO-153



## IMPORTANT NOTICE AND DISCLAIMER

TI PROVIDES TECHNICAL AND RELIABILITY DATA (INCLUDING DATA SHEETS), DESIGN RESOURCES (INCLUDING REFERENCE DESIGNS), APPLICATION OR OTHER DESIGN ADVICE, WEB TOOLS, SAFETY INFORMATION, AND OTHER RESOURCES "AS IS" AND WITH ALL FAULTS, AND DISCLAIMS ALL WARRANTIES, EXPRESS AND IMPLIED, INCLUDING WITHOUT LIMITATION ANY IMPLIED WARRANTIES OF MERCHANTABILITY, FITNESS FOR A PARTICULAR PURPOSE OR NON-INFRINGEMENT OF THIRD PARTY INTELLECTUAL PROPERTY RIGHTS.

These resources are intended for skilled developers designing with TI products. You are solely responsible for (1) selecting the appropriate TI products for your application, (2) designing, validating and testing your application, and (3) ensuring your application meets applicable standards, and any other safety, security, regulatory or other requirements.

These resources are subject to change without notice. TI grants you permission to use these resources only for development of an application that uses the TI products described in the resource. Other reproduction and display of these resources is prohibited. No license is granted to any other TI intellectual property right or to any third party intellectual property right. TI disclaims responsibility for, and you will fully indemnify TI and its representatives against, any claims, damages, costs, losses, and liabilities arising out of your use of these resources.

TI's products are provided subject to [TI's Terms of Sale](#) or other applicable terms available either on [ti.com](https://www.ti.com) or provided in conjunction with such TI products. TI's provision of these resources does not expand or otherwise alter TI's applicable warranties or warranty disclaimers for TI products.

TI objects to and rejects any additional or different terms you may have proposed.

Mailing Address: Texas Instruments, Post Office Box 655303, Dallas, Texas 75265  
Copyright © 2024, Texas Instruments Incorporated