

NCP2820 Series

2.65 W Filterless Class-D Audio Power Amplifier

The NCP2820 is a cost-effective mono Class-D audio power amplifier capable of delivering 2.65 W of continuous average power to 4.0 Ω from a 5.0 V supply in a Bridge Tied Load (BTL) configuration. Under the same conditions, the output power stage can provide 1.4 W to a 8.0 Ω BTL load with less than 1% THD+N. For cellular handsets or PDAs it offers space and cost savings because no output filter is required when using inductive transducers. With more than 90% efficiency and very low shutdown current, it increases the lifetime of your battery and drastically lowers the junction temperature.

The NCP2820 processes analog inputs with a pulse width modulation technique that lowers output noise and THD when compared to a conventional sigma-delta modulator. The device allows independent gain while summing signals from various audio sources. Thus, in cellular handsets, the earpiece, the loudspeaker and even the melody ringer can be driven with a single NCP2820. Due to its low 42 μ V noise floor, A-weighted, a clean listening is guaranteed no matter the load sensitivity. With zero pop and click noise performance NCP2820A turns on within 1 ms versus 9 ms for NCP2820 version.

Features

- Optimized PWM Output Stage: Filterless Capability
- Efficiency up to 90%
Low 2.5 mA Typical Quiescent Current
- Large Output Power Capability: 1.4 W with 8.0 Ω Load (CSP) and THD + N < 1%
- Ultra Fast Start-up Time: 1 ms for NCP2820A Version
- High Performance, THD+N of 0.03% @ $V_p = 5.0$ V,
 $R_L = 8.0$ Ω , $P_{out} = 100$ mW
- Excellent PSRR (-65 dB): No Need for Voltage Regulation
- Surface Mounted Package 9-Pin Flip-Chip CSP and UDFN8
- Fully Differential Design. Eliminates Two Input Coupling Capacitors
- Very Fast Turn On/Off Times with Advanced Rising and Falling Gain Technique
- External Gain Configuration Capability
- Internally Generated 250 kHz Switching Frequency
- "Pop and Click" Noise Protection Circuitry
- NCV Prefix for Automotive and Other Applications Requiring Unique Site and Control Change Requirements; AEC-Q100 Qualified and PPAP Capable
- These are Pb-Free Devices

Applications

- Cellular Phone
- Portable Electronic Devices
- PDAs and Smart Phones
- Portable Computer



ON Semiconductor®

<http://onsemi.com>

MARKING DIAGRAMS



9-PIN FLIP-CHIP CSP
FC SUFFIX
CASE 499AL

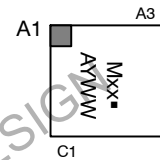

xx = AQ for NCP2820
= BD for NCP2820A
A = Assembly Location
Y = Year
WW = Work Week
▪ = Pb-Free Package

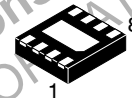

8 PIN UDFN 2x2.2
MU SUFFIX
CASE 506AV

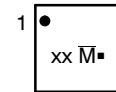

xx = ZB for NCP2820
= AT for NCV2820
M = Date Code
▪ = Pb-Free Package

ORDERING INFORMATION

See detailed ordering and shipping information on page 19 of this data sheet.

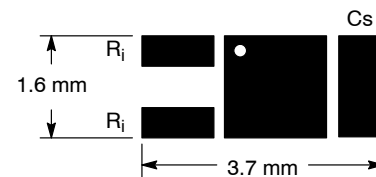
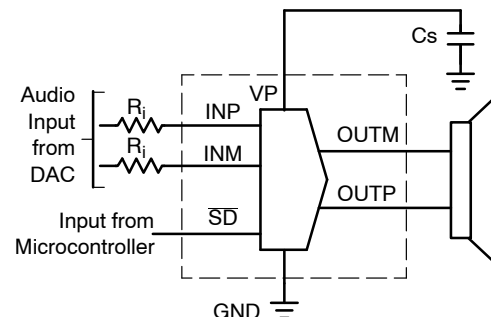

NCP2820 Series

PIN CONNECTIONS

9-Pin Flip-Chip CSP

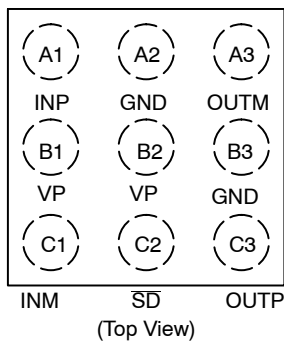

UDFN8

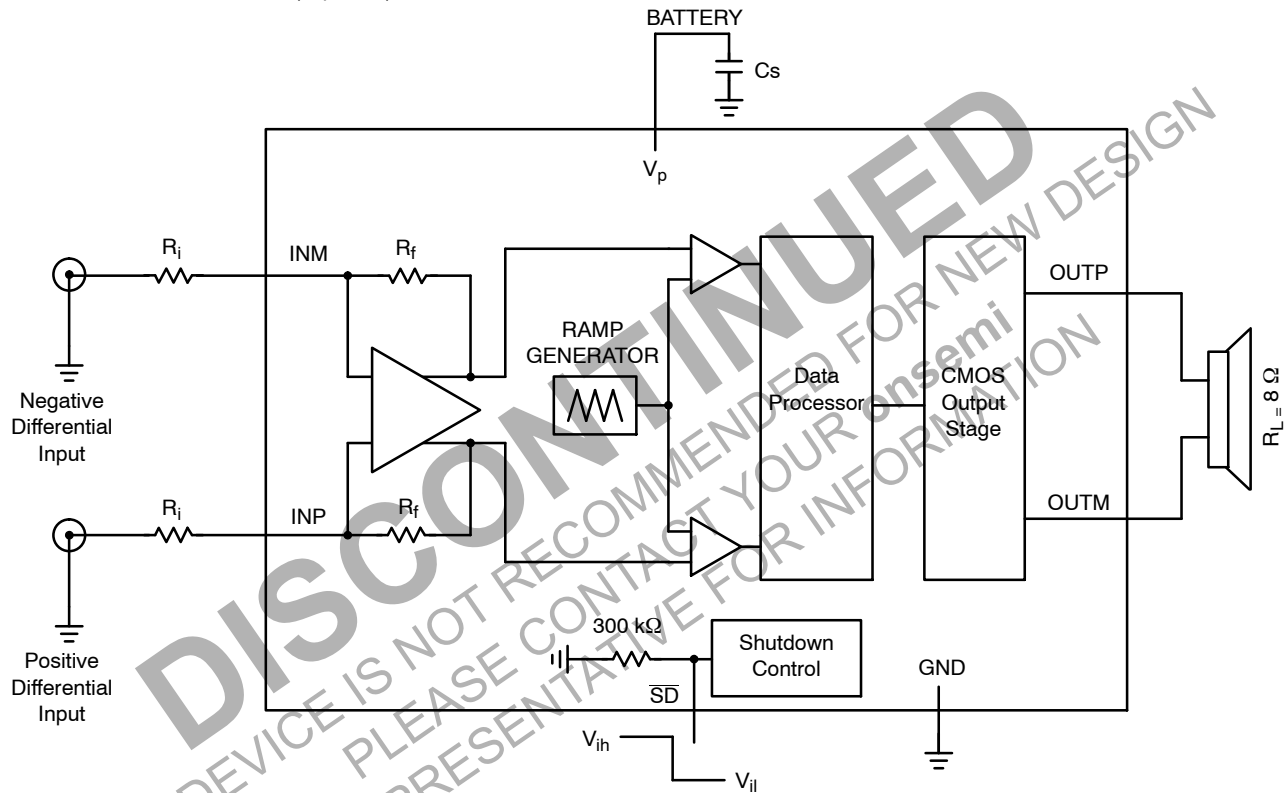
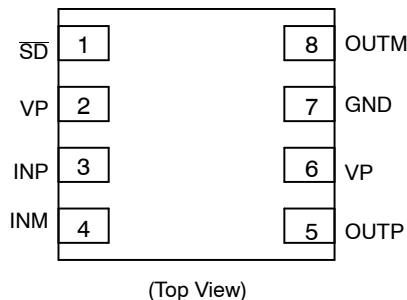

Figure 1. Typical Application

PIN DESCRIPTION

Pin No.		Symbol	Type	Description
CSP	UDFN8			
A1	3	INP	I	Positive Differential Input.
A2	7	GND	I	Analog Ground.
A3	8	OUTM	O	Negative BTL Output.
B1	2	V _p	I	Analog Positive Supply. Range: 2.5 V – 5.5 V.
B2	6	V _p	I	Power Analog Positive Supply. Range: 2.5 V – 5.5 V.
B3	7	GND	I	Analog Ground.
C1	4	INM	I	Negative Differential Input.
C2	1	\overline{SD}	I	The device enters in Shutdown Mode when a low level is applied on this pin. An internal 300 kΩ resistor will force the device in shutdown mode if no signal is applied to this pin. It also helps to save space and cost.
C3	5	OUTP	O	Positive BTL Output.

NCP2820 Series

MAXIMUM RATINGS

Symbol	Rating	Max	Unit
V_p	Supply Voltage Active Mode Shutdown Mode	6.0 7.0	V
V_{in}	Input Voltage	-0.3 to $V_{CC} + 0.3$	V
I_{out}	Max Output Current (Note 1)	1.5	A
P_d	Power Dissipation (Note 2)	Internally Limited	-
T_A	Operating Ambient Temperature	-40 to +85	°C
T_J	Max Junction Temperature	150	°C
T_{stg}	Storage Temperature Range	-65 to +150	°C
$R_{\theta JA}$	Thermal Resistance Junction-to-Air 9-Pin Flip-Chip UDFN8	90 (Note 3) 50	°C/W
-	ESD Protection Human Body Model (HBM) (Note 4)	> 2000	V
-	Machine Model (MM) (Note 5)	> 200	
-	Latchup Current @ $T_A = 85^\circ\text{C}$ (Note 6) 9-Pin Flip-Chip UDFN8	± 70 ± 100	mA
MSL	Moisture Sensitivity (Note 7)	Level 1	

Stresses exceeding Maximum Ratings may damage the device. Maximum Ratings are stress ratings only. Functional operation above the Recommended Operating Conditions is not implied. Extended exposure to stresses above the Recommended Operating Conditions may affect device reliability.

- The device is protected by a current breaker structure. See "Current Breaker Circuit" in the Description Information section for more information.
- The thermal shutdown is set to 160°C (typical) avoiding irreversible damage to the device due to power dissipation.
- For the 9-Pin Flip-Chip CSP package, the $R_{\theta JA}$ is highly dependent of the PCB Heatsink area. For example, $R_{\theta JA}$ can equal 195°C/W with 50 mm² total area and also 135°C/W with 500 mm². When using ground and power planes, the value is around 90°C/W, as specified in table.
- Human Body Model: 100 pF discharged through a 1.5 kΩ resistor following specification JESD22/A114. On 9-Pin Flip-Chip, B2 Pin (V_p) is qualified at 1500 V.
- Machine Model: 200 pF discharged through all pins following specification JESD22/A115.
- Latchup Testing per JEDEC Standard JESD78.
- Moisture Sensitivity Level (MSL): 1 per IPC/JEDEC standard: J-STD-020A.

NCP2820 Series

ELECTRICAL CHARACTERISTICS (Limits apply for $T_A = +25^\circ\text{C}$ unless otherwise noted) (NCP2820FCT1G & NCP2820FCT2G)

Characteristic	Symbol	Conditions	Min	Typ	Max	Unit
Operating Supply Voltage	V_p	$T_A = -40^\circ\text{C}$ to $+85^\circ\text{C}$	2.5	–	5.5	V
Supply Quiescent Current	I_{dd}	$V_p = 3.6\text{ V}$, $R_L = 8.0\ \Omega$ $V_p = 5.5\text{ V}$, No Load V_p from 2.5 V to 5.5 V, No Load $T_A = -40^\circ\text{C}$ to $+85^\circ\text{C}$	–	2.15 2.61	–	mA
Shutdown Current	I_{sd}	$V_p = 4.2\text{ V}$ $T_A = +25^\circ\text{C}$ $T_A = +85^\circ\text{C}$	–	0.42 0.45	0.8 –	μA
		$V_p = 5.5\text{ V}$ $T_A = +25^\circ\text{C}$ $T_A = +85^\circ\text{C}$	–	0.8 0.9	1.5 –	μA
Shutdown Voltage High	V_{sdih}	–	1.2	–	–	V
Shutdown Voltage Low	V_{sdil}	–	–	–	0.4	V
Switching Frequency	F_{sw}	V_p from 2.5 V to 5.5 V $T_A = -40^\circ\text{C}$ to $+85^\circ\text{C}$	190	250	310	kHz
Gain	G	$R_L = 8.0\ \Omega$	$285\text{ k}\Omega$ R_i	$300\text{ k}\Omega$ R_i	$315\text{ k}\Omega$ R_i	$\frac{\text{V}}{\text{V}}$
Output Impedance in Shutdown Mode	Z_{SD}	–	–	300	–	Ω
Resistance from $\overline{\text{SD}}$ to GND	R_s	–	–	300	–	$\text{k}\Omega$
Output Offset Voltage	V_{os}	$V_p = 5.5\text{ V}$	–	6.0	–	mV
Turn On Time	T_{on}	V_p from 2.5 V to 5.5 V	–	9.0 1.0	– 3.0	ms
Turn Off Time	T_{off}	V_p from 2.5 V to 5.5 V	–	5.0 0.5	– –	ms
Thermal Shutdown Temperature	T_{sd}	–	–	160	–	$^\circ\text{C}$
Output Noise Voltage	V_n	$V_p = 3.6\text{ V}$, $f = 20\text{ Hz}$ to 20 kHz no weighting filter with A weighting filter	–	65 42	–	μVrms
RMS Output Power	P_o	$R_L = 8.0\ \Omega$, $f = 1.0\text{ kHz}$, THD+N < 1% $V_p = 2.5\text{ V}$ $V_p = 3.0\text{ V}$ $V_p = 3.6\text{ V}$ $V_p = 4.2\text{ V}$ $V_p = 5.0\text{ V}$	–	0.32 0.48 0.7 0.97 1.38	–	W
		$R_L = 8.0\ \Omega$, $f = 1.0\text{ kHz}$, THD+N < 10% $V_p = 2.5\text{ V}$ $V_p = 3.0\text{ V}$ $V_p = 3.6\text{ V}$ $V_p = 4.2\text{ V}$ $V_p = 5.0\text{ V}$	–	0.4 0.59 0.87 1.19 1.7	–	W
		$R_L = 4.0\ \Omega$, $f = 1.0\text{ kHz}$, THD+N < 1% $V_p = 2.5\text{ V}$ $V_p = 3.0\text{ V}$ $V_p = 3.6\text{ V}$ $V_p = 4.2\text{ V}$ $V_p = 5.0\text{ V}$	–	0.49 0.72 1.06 1.62 2.12	–	W
		$R_L = 4.0\ \Omega$, $f = 1.0\text{ kHz}$, THD+N < 10% $V_p = 2.5\text{ V}$ $V_p = 3.0\text{ V}$ $V_p = 3.6\text{ V}$ $V_p = 4.2\text{ V}$ $V_p = 5.0\text{ V}$	–	0.6 0.9 1.33 2.0 2.63	–	W
		$R_L = 4.0\ \Omega$, $f = 1.0\text{ kHz}$, THD+N < 10% $V_p = 2.5\text{ V}$ $V_p = 3.0\text{ V}$ $V_p = 3.6\text{ V}$ $V_p = 4.2\text{ V}$ $V_p = 5.0\text{ V}$	–	0.6 0.9 1.33 2.0 2.63	–	W

NCP2820 Series

ELECTRICAL CHARACTERISTICS (Limits apply for $T_A = +25^\circ\text{C}$ unless otherwise noted) (NCP2820FCT1G & NCP2820FCT2G)

Characteristic	Symbol	Conditions	Min	Typ	Max	Unit
Efficiency	-	$R_L = 8.0 \Omega$, $f = 1.0 \text{ kHz}$ $V_p = 5.0 \text{ V}$, $P_{out} = 1.2 \text{ W}$ $V_p = 3.6 \text{ V}$, $P_{out} = 0.6 \text{ W}$	-	91	-	%
		$R_L = 4.0 \Omega$, $f = 1.0 \text{ kHz}$ $V_p = 5.0 \text{ V}$, $P_{out} = 2.0 \text{ W}$ $V_p = 3.6 \text{ V}$, $P_{out} = 1.0 \text{ W}$	-	82 81	-	
Total Harmonic Distortion + Noise	THD+N	$V_p = 5.0 \text{ V}$, $R_L = 8.0 \Omega$, $f = 1.0 \text{ kHz}$, $P_{out} = 0.25 \text{ W}$ $V_p = 3.6 \text{ V}$, $R_L = 8.0 \Omega$, $f = 1.0 \text{ kHz}$, $P_{out} = 0.25 \text{ W}$	-	0.05 0.09	-	%
Common Mode Rejection Ratio	CMRR	V_p from 2.5 V to 5.5 V $V_{ic} = 0.5 \text{ V}$ to $V_p - 0.8 \text{ V}$ $V_p = 3.6 \text{ V}$, $V_{ic} = 1.0 V_{pp}$ $f = 217 \text{ Hz}$	-	-62	-	dB
		$f = 1.0 \text{ kHz}$	-	-56 -57	-	
Power Supply Rejection Ratio	PSRR	$V_{p_ripple_pk-pk} = 200 \text{ mV}$, $R_L = 8.0 \Omega$, Inputs AC Grounded $V_p = 3.6 \text{ V}$ $f = 217 \text{ kHz}$ $f = 1.0 \text{ kHz}$	-	-62 -65	-	dB

ELECTRICAL CHARACTERISTICS (Limits apply for $T_A = +25^\circ\text{C}$ unless otherwise noted) (NCP2820MUTBG & NCV2820MUTBG)

Characteristic	Symbol	Conditions	Min	Typ	Max	Unit
Operating Supply Voltage	V_p	$T_A = -40^\circ\text{C}$ to $+85^\circ\text{C}$	2.5	-	5.5	V
Supply Quiescent Current	I_{dd}	$V_p = 3.6 \text{ V}$, $R_L = 8.0 \Omega$ $V_p = 5.5 \text{ V}$, No Load	-	2.15 2.61	-	mA
		V_p from 2.5 V to 5.5 V, No Load $T_A = -40^\circ\text{C}$ to $+85^\circ\text{C}$	-	-	3.8	
Shutdown Current	I_{sd}	$V_p = 4.2 \text{ V}$ $T_A = +25^\circ\text{C}$ $T_A = +85^\circ\text{C}$	-	0.42 0.45	0.8 2.0	μA
		$V_p = 5.5 \text{ V}$ $T_A = +25^\circ\text{C}$ $T_A = +85^\circ\text{C}$	-	0.8 0.9	1.5 -	
Shutdown Voltage High	V_{sdih}	-	1.2	-	-	V
Shutdown Voltage Low	V_{sdil}	-	-	-	0.4	V
Switching Frequency	F_{sw}	V_p from 2.5 V to 5.5 V $T_A = -40^\circ\text{C}$ to $+85^\circ\text{C}$	180	240	300	kHz
Gain	G	$R_L = 8.0 \Omega$	$\frac{285 \text{ k}\Omega}{R_i}$	$\frac{300 \text{ k}\Omega}{R_i}$	$\frac{315 \text{ k}\Omega}{R_i}$	$\frac{V}{V}$
Output Impedance in Shutdown Mode	Z_{SD}	-	-	20	-	k Ω
Resistance from \overline{SD} to GND	R_s	-	-	300	-	k Ω
Output Offset Voltage	V_{os}	$V_p = 5.5 \text{ V}$	-	6.0	-	mV
Turn On Time	T_{on}	V_p from 2.5 V to 5.5 V	-	1.0	-	μs
Turn Off Time	T_{off}	V_p from 2.5 V to 5.5 V	-	1.0	-	μs
Thermal Shutdown Temperature	T_{sd}	-	-	160	-	$^\circ\text{C}$
Output Noise Voltage	V_n	$V_p = 3.6 \text{ V}$, $f = 20 \text{ Hz}$ to 20 kHz no weighting filter	-	65	-	μV_{rms}
		with A weighting filter	-	42	-	

NCP2820 Series

ELECTRICAL CHARACTERISTICS (Limits apply for $T_A = +25^\circ\text{C}$ unless otherwise noted) (NCP2820MUTBG & NCV2820MUTBG)

Characteristic	Symbol	Conditions	Min	Typ	Max	Unit
RMS Output Power	Po	$R_L = 8.0 \Omega, f = 1.0 \text{ kHz}, \text{THD+N} < 1\%$	–	0.22	–	W
		$V_p = 2.5 \text{ V}$	–	0.33	–	
		$V_p = 3.0 \text{ V}$	–	0.45	–	
		$V_p = 3.6 \text{ V}$	–	0.67	–	
		$V_p = 4.2 \text{ V}$	–	0.92	–	
		$V_p = 5.0 \text{ V}$	–	–	–	
		$R_L = 8.0 \Omega, f = 1.0 \text{ kHz}, \text{THD+N} < 10\%$	–	0.36	–	W
		$V_p = 2.5 \text{ V}$	–	0.53	–	
$V_p = 3.0 \text{ V}$	–	0.76	–			
$V_p = 3.6 \text{ V}$	–	1.07	–			
$V_p = 4.2 \text{ V}$	–	1.49	–			
$V_p = 5.0 \text{ V}$	–	–	–			
Efficiency	–	$R_L = 8.0 \Omega, f = 1.0 \text{ kHz}$	–	87	–	%
		$V_p = 5.0 \text{ V}, P_{\text{out}} = 1.2 \text{ W}$	–	87	–	
		$V_p = 3.6 \text{ V}, P_{\text{out}} = 0.6 \text{ W}$	–	–	–	
		$R_L = 4.0 \Omega, f = 1.0 \text{ kHz}$	–	79	–	
		$V_p = 5.0 \text{ V}, P_{\text{out}} = 2.0 \text{ W}$	–	78	–	
		$V_p = 3.6 \text{ V}, P_{\text{out}} = 1.0 \text{ W}$	–	–	–	
		$V_p = 2.5 \text{ V}$	–	0.52	–	W
		$V_p = 3.0 \text{ V}$	–	0.8	–	
$V_p = 3.6 \text{ V}$	–	1.125	–			
$V_p = 4.2 \text{ V}$	–	1.58	–			
$V_p = 5.0 \text{ V}$	–	2.19	–			
Total Harmonic Distortion + Noise	THD+N	$V_p = 5.0 \text{ V}, R_L = 8.0 \Omega,$ $f = 1.0 \text{ kHz}, P_{\text{out}} = 0.25 \text{ W}$	–	0.05	–	%
		$V_p = 3.6 \text{ V}, R_L = 8.0 \Omega,$ $f = 1.0 \text{ kHz}, P_{\text{out}} = 0.25 \text{ W}$	–	0.06	–	
Common Mode Rejection Ratio	CMRR	V_p from 2.5 V to 5.5 V $V_{\text{ic}} = 0.5 \text{ V to } V_p - 0.8 \text{ V}$	–	–62	–	dB
		$V_p = 3.6 \text{ V}, V_{\text{ic}} = 1.0 V_{\text{pp}}$ $f = 217 \text{ Hz}$	–	–56	–	
		$f = 1.0 \text{ kHz}$	–	–57	–	
Power Supply Rejection Ratio	PSRR	$V_{p_ripple_pk-pk} = 200 \text{ mV}, R_L = 8.0 \Omega,$ Inputs AC Grounded	–	–62	–	dB
		$V_p = 3.6 \text{ V}$ $f = 217 \text{ kHz}$	–	–65	–	
		$f = 1.0 \text{ kHz}$	–	–	–	

NCP2820 Series

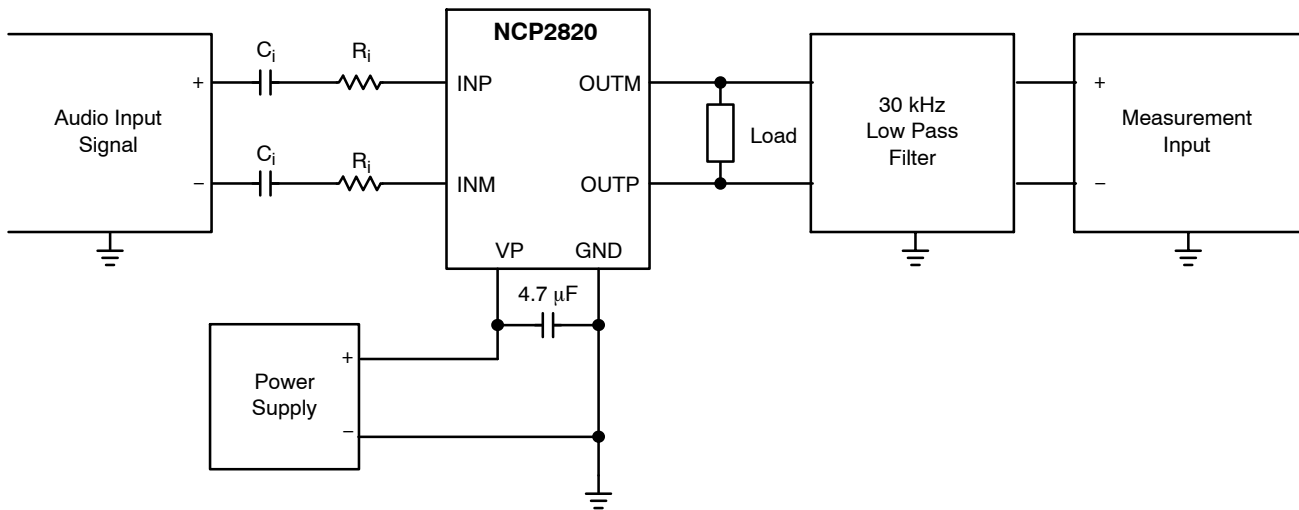

Figure 2. Test Setup for Graphs

NOTES:

1. Unless otherwise noted, $C_i = 100 \text{ nF}$ and $R_i = 150 \text{ k}\Omega$. Thus, the gain setting is 2 V/V and the cutoff frequency of the input high pass filter is set to 10 Hz . Input capacitors are shorted for CMRR measurements.
2. To closely reproduce a real application case, all measurements are performed using the following loads:
 - $R_L = 8 \Omega$ means Load = $15 \mu\text{H} + 8 \Omega + 15 \mu\text{H}$
 - $R_L = 4 \Omega$ means Load = $15 \mu\text{H} + 4 \Omega + 15 \mu\text{H}$
 Very low DCR $15 \mu\text{H}$ inductors ($50 \text{ m}\Omega$) have been used for the following graphs. Thus, the electrical load measurements are performed on the resistor (8Ω or 4Ω) in differential mode.
3. For Efficiency measurements, the optional 30 kHz filter is used. An RC low-pass filter is selected with (100Ω , 47 nF) on each PWM output.

DISCONTINUED

THIS DEVICE IS NOT RECOMMENDED FOR NEW DESIGN
PLEASE CONTACT YOUR ONSEMI REPRESENTATIVE FOR INFORMATION

NCP2820 Series

TYPICAL CHARACTERISTICS

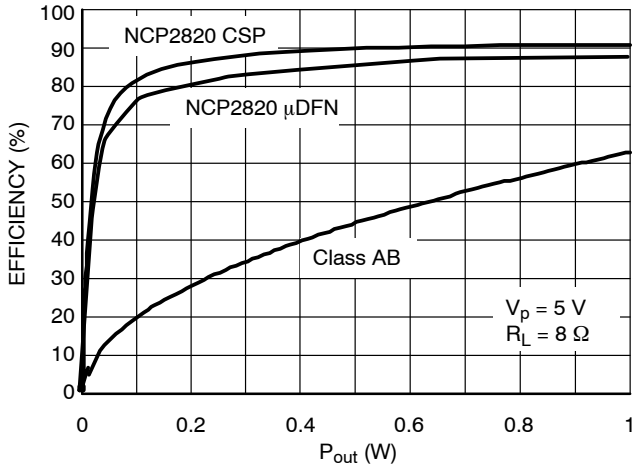

Figure 3. Efficiency vs. P_{out}
 $V_p = 5\text{ V}$, $R_L = 8\ \Omega$, $f = 1\text{ kHz}$

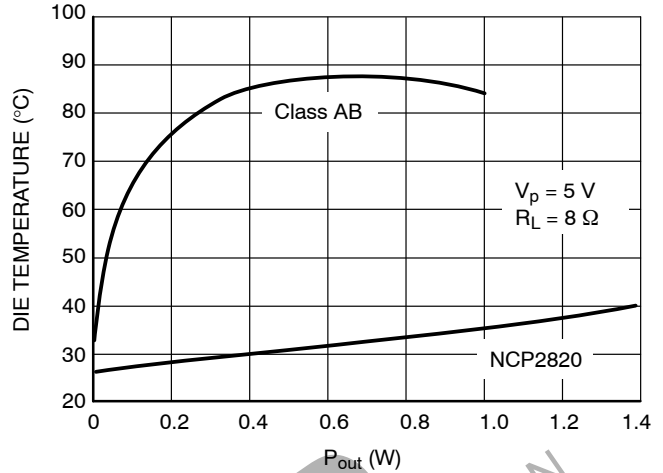

Figure 4. Die Temperature vs. P_{out}
 $V_p = 5\text{ V}$, $R_L = 8\ \Omega$, $f = 1\text{ kHz}$ @ $T_A = +25^\circ\text{C}$

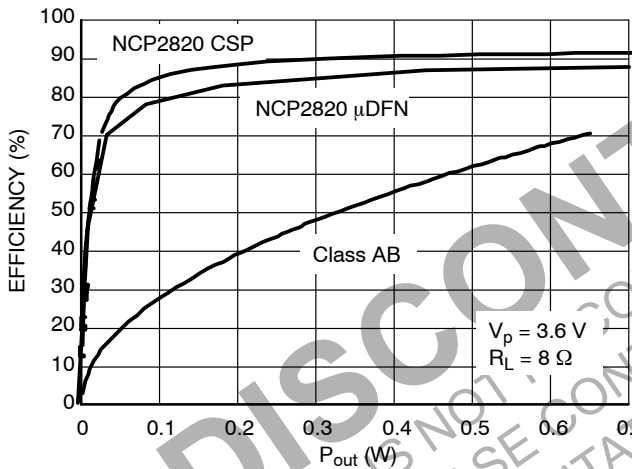

Figure 5. Efficiency vs. P_{out}
 $V_p = 3.6\text{ V}$, $R_L = 8\ \Omega$, $f = 1\text{ kHz}$

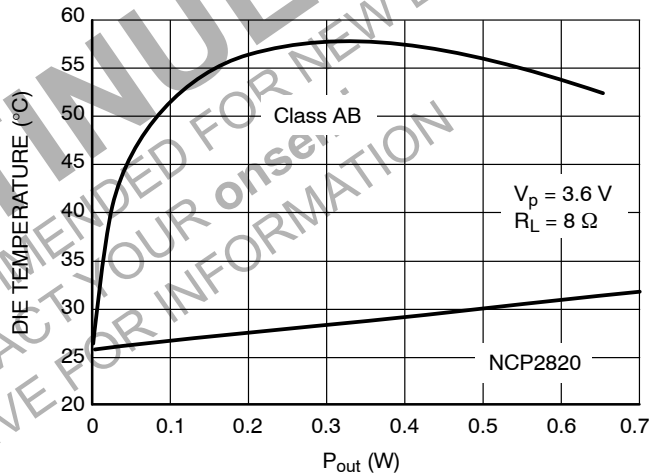

Figure 8. Die Temperature vs. P_{out}
 $V_p = 3.6\text{ V}$, $R_L = 8\ \Omega$, $f = 1\text{ kHz}$ @ $T_A = +25^\circ\text{C}$

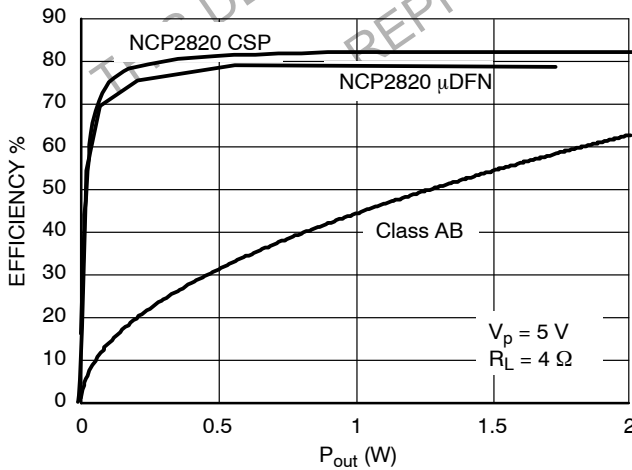

Figure 6. Efficiency vs. P_{out}
 $V_p = 5\text{ V}$, $R_L = 4\ \Omega$, $f = 1\text{ kHz}$

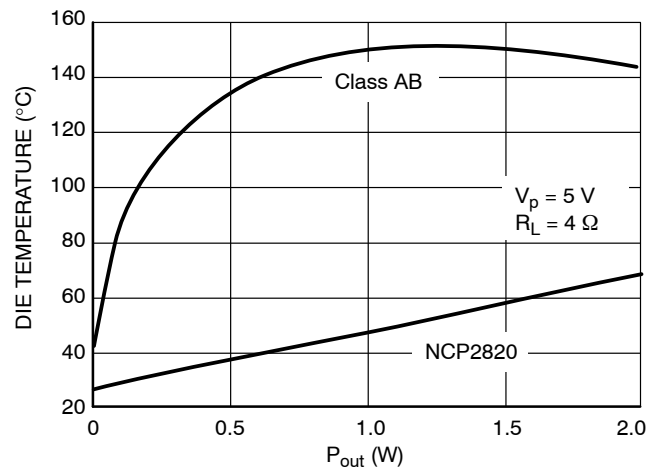

Figure 7. Die Temperature vs. P_{out}
 $V_p = 5\text{ V}$, $R_L = 4\ \Omega$, $f = 1\text{ kHz}$ @ $T_A = +25^\circ\text{C}$

NCP2820 Series

TYPICAL CHARACTERISTICS

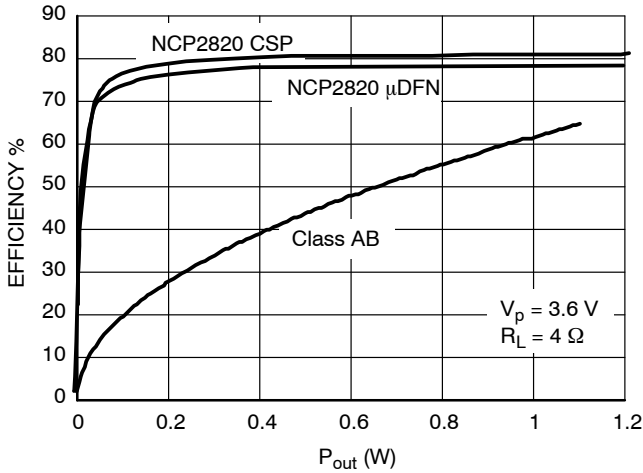

Figure 9. Efficiency vs. P_{out}
 $V_p = 3.6\text{ V}$, $R_L = 4\ \Omega$, $f = 1\text{ kHz}$

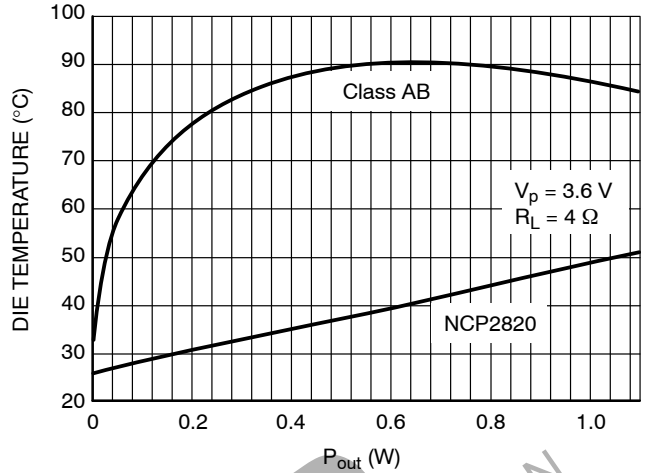

Figure 10. Die Temperature vs. P_{out}
 $V_p = 3.6\text{ V}$, $R_L = 4\ \Omega$, $f = 1\text{ kHz}$ @ $T_A = +25^\circ\text{C}$

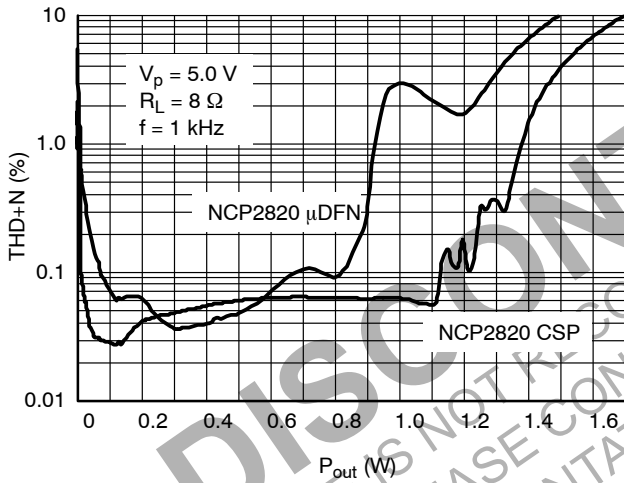

Figure 11. THD+N vs. P_{out}
 $V_p = 5\text{ V}$, $R_L = 8\ \Omega$, $f = 1\text{ kHz}$

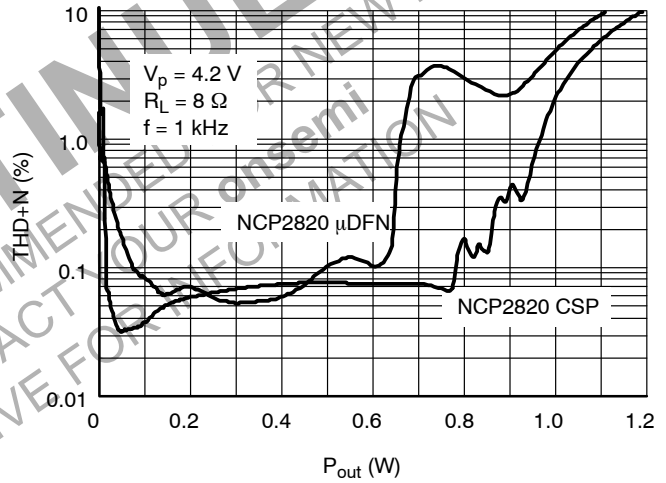

Figure 12. THD+N vs. P_{out}
 $V_p = 4.2\text{ V}$, $R_L = 8\ \Omega$, $f = 1\text{ kHz}$

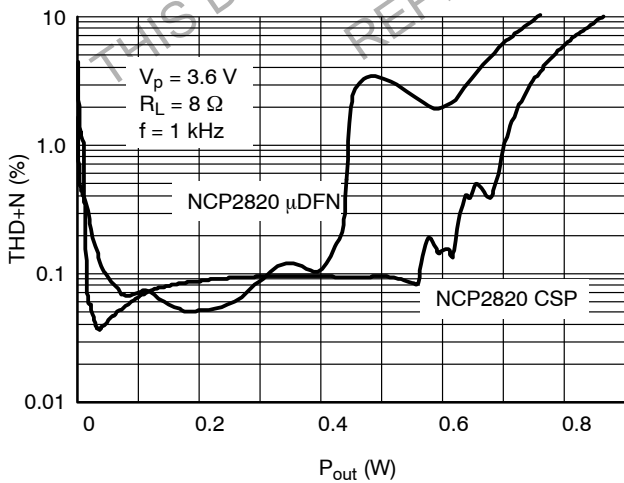

Figure 13. THD+N vs. P_{out}
 $V_p = 3.6\text{ V}$, $R_L = 8\ \Omega$, $f = 1\text{ kHz}$

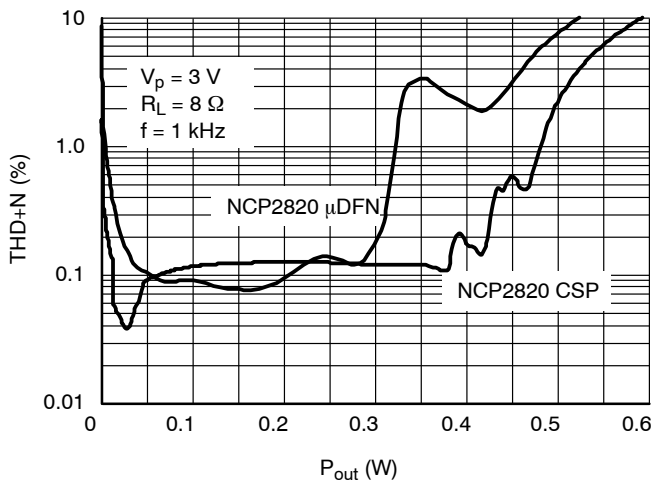

Figure 14. THD+N vs. P_{out}
 $V_p = 3\text{ V}$, $R_L = 8\ \Omega$, $f = 1\text{ kHz}$

NCP2820 Series

TYPICAL CHARACTERISTICS

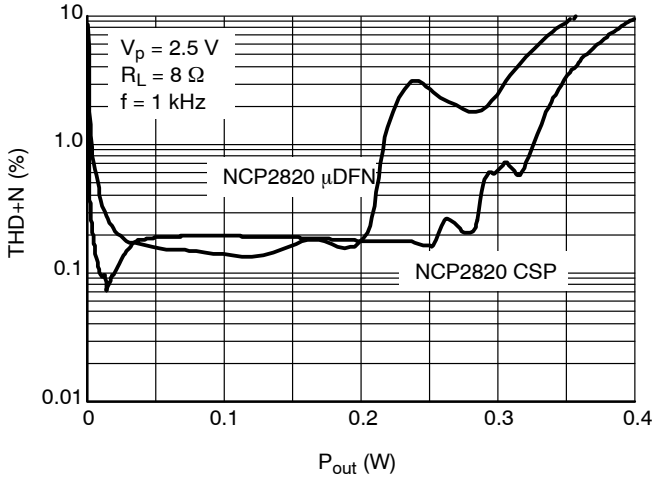

Figure 15. THD+N vs. Pout
 $V_p = 2.5 \text{ V}, R_L = 8 \Omega, f = 1 \text{ kHz}$

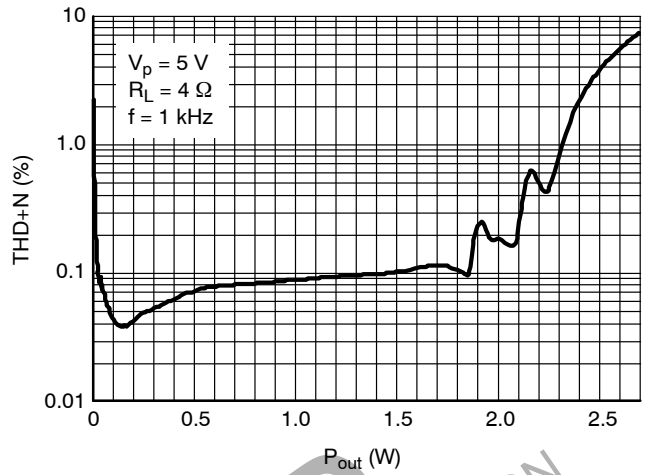

Figure 16. THD+N vs. Pout
 $V_p = 5 \text{ V}, R_L = 4 \Omega, f = 1 \text{ kHz}$

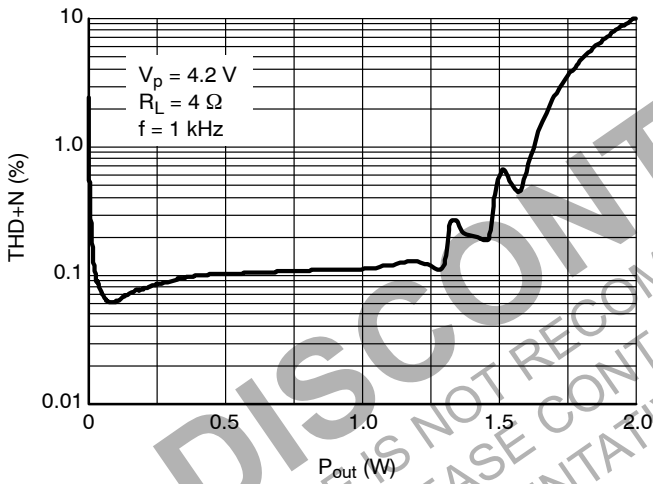

Figure 17. THD+N vs. Pout
 $V_p = 4.2 \text{ V}, R_L = 4 \Omega, f = 1 \text{ kHz}$

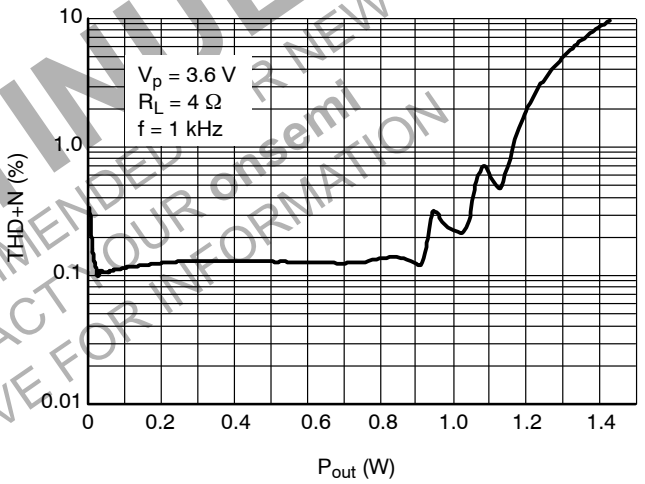

Figure 18. THD+N vs. Pout
 $V_p = 3.6 \text{ V}, R_L = 4 \Omega, f = 1 \text{ kHz}$

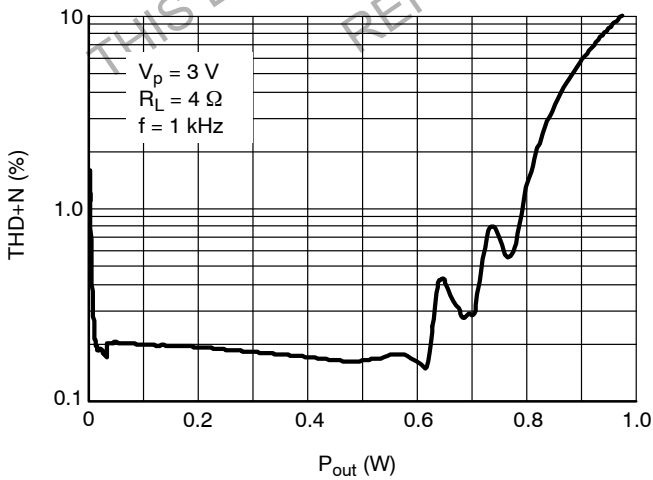

Figure 19. THD+N vs. Power Out
 $V_p = 3 \text{ V}, R_L = 4 \Omega, f = 1 \text{ kHz}$

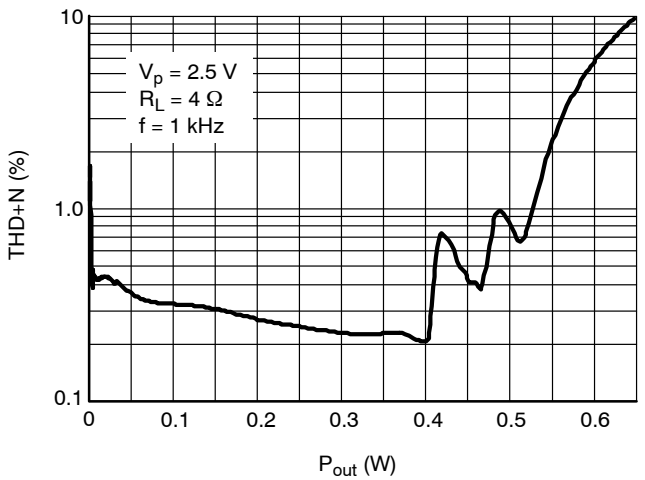

Figure 20. THD+N vs. Power Out
 $V_p = 2.5 \text{ V}, R_L = 4 \Omega, f = 1 \text{ kHz}$

NCP2820 Series

TYPICAL CHARACTERISTICS

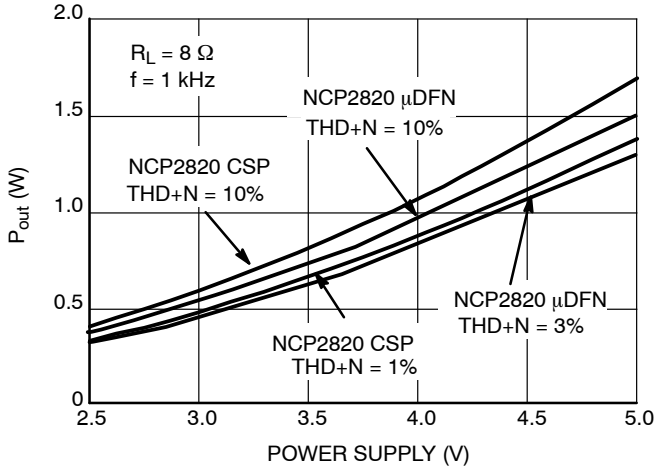

Figure 21. Output Power vs. Power Supply
 $R_L = 8 \Omega$ @ $f = 1 \text{ kHz}$

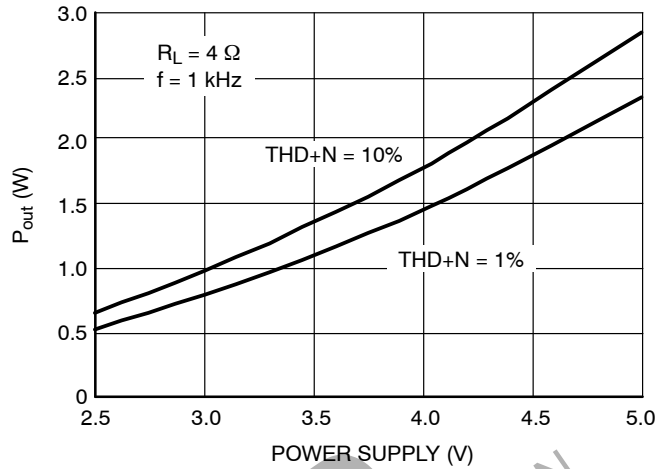

Figure 22. Output Power vs. Power Supply
 $R_L = 4 \Omega$ @ $f = 1 \text{ kHz}$

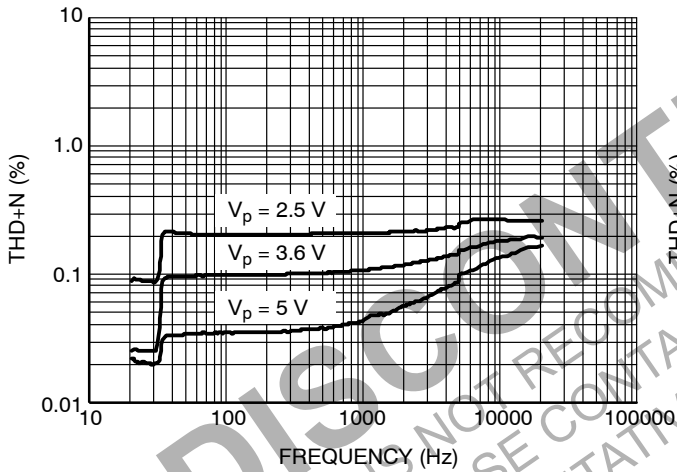

Figure 23. THD+N vs. Frequency
 $R_L = 8 \Omega$, $P_{out} = 250 \text{ mW}$ @ $f = 1 \text{ kHz}$

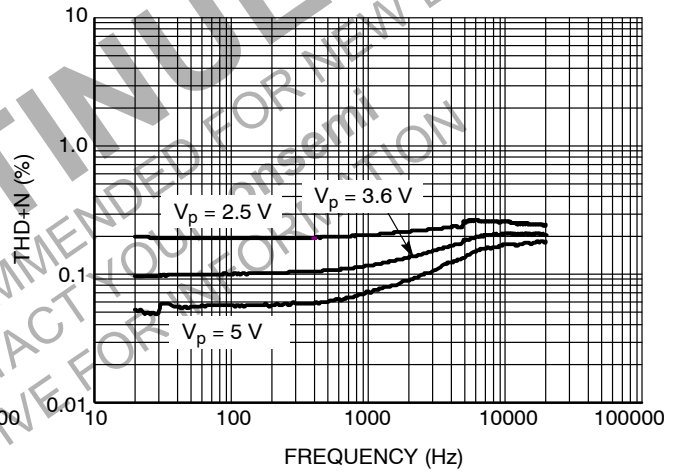

Figure 24. THD+N vs. Frequency
 $R_L = 4 \Omega$, $P_{out} = 250 \text{ mW}$ @ $f = 1 \text{ kHz}$

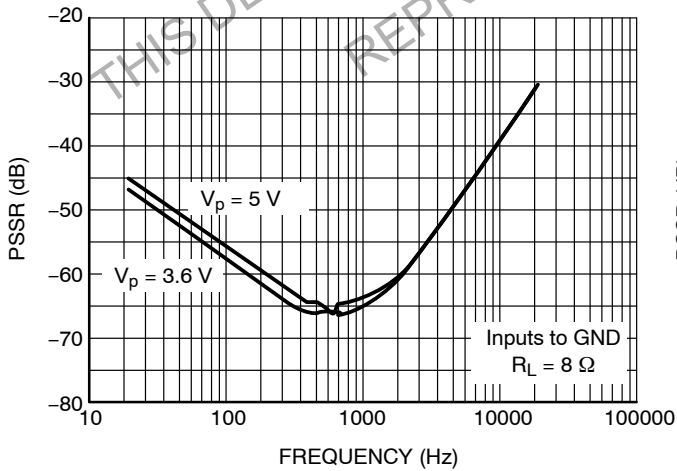

Figure 25. PSRR vs. Frequency
 Inputs Grounded, $R_L = 8 \Omega$, Vripple = 200 mVpkpk

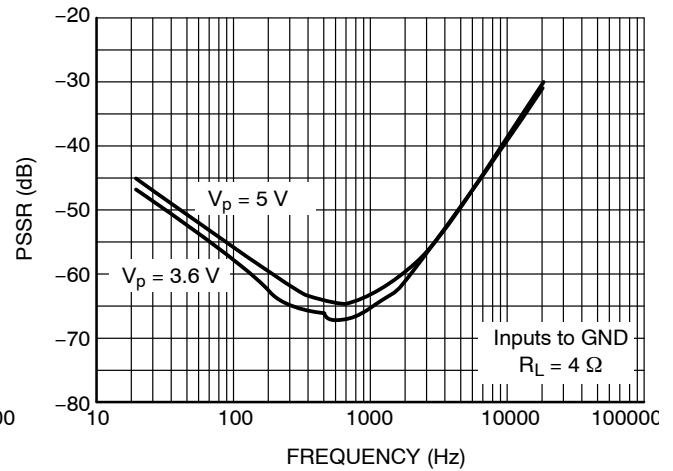

Figure 26. PSRR vs. Frequency
 Inputs grounded, $R_L = 4 \Omega$, Vripple = 200 mVpkpk

TYPICAL CHARACTERISTICS

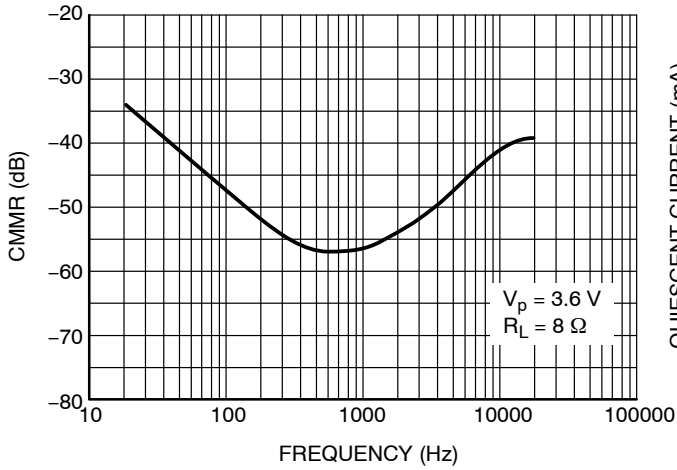

Figure 27. PSRR vs. Frequency
 $V_p = 3.6\text{ V}$, $R_L = 8\ \Omega$, $V_{ic} = 200\text{ mVpkpk}$

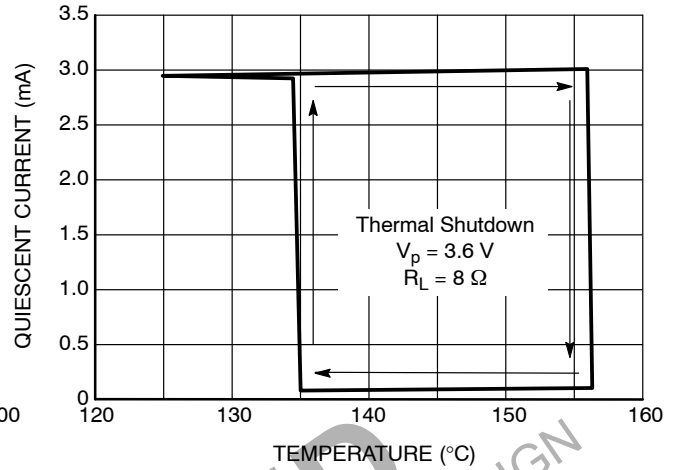

Figure 28. Thermal Shutdown vs. Temperature
 $V_p = 5\text{ V}$, $R_L = 8\ \Omega$

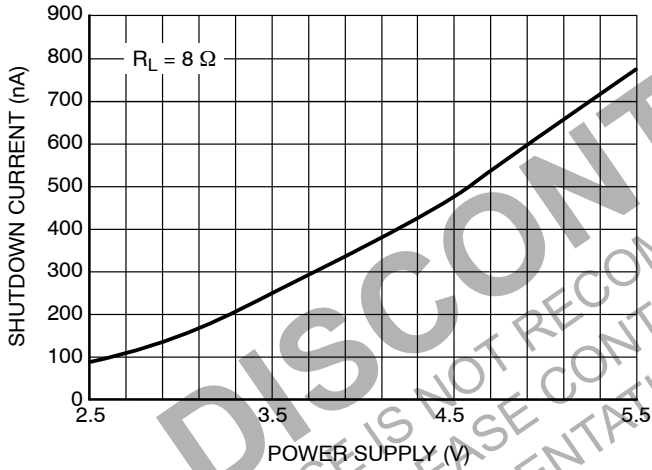

Figure 29. Shutdown Current vs. Power Supply
 $R_L = 8\ \Omega$

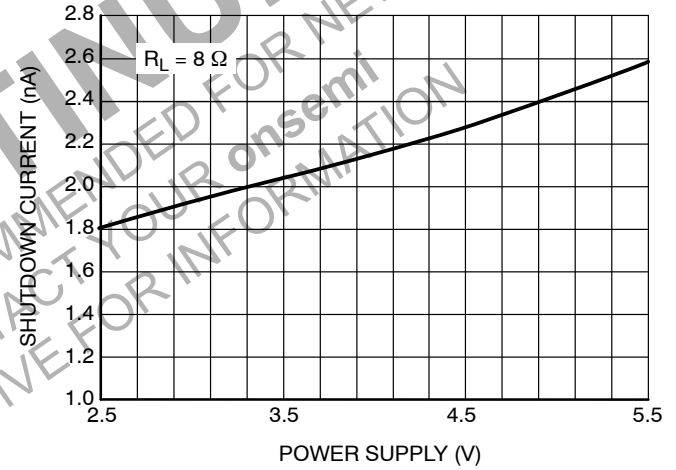

Figure 30. Quiescent Current vs. Power Supply
 $R_L = 8\ \Omega$

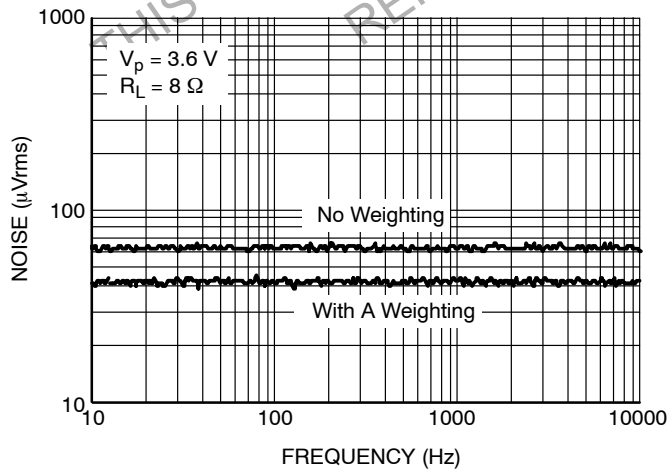

Figure 31. Noise Floor, Inputs AC Grounded
 with $1\ \mu\text{F}$ $V_p = 3.6\text{ V}$

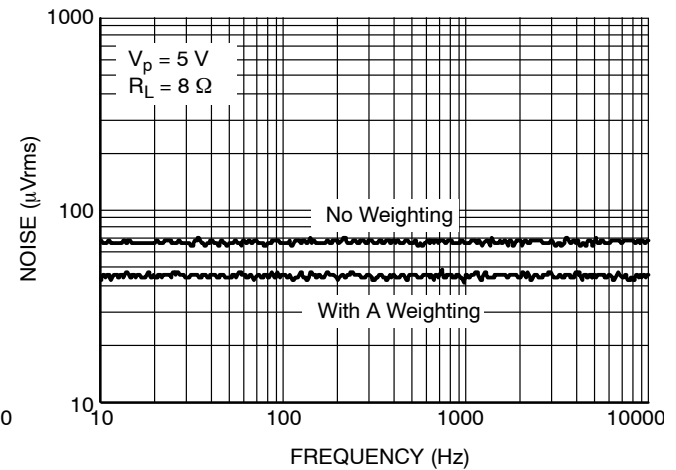

Figure 32. Noise Floor, Inputs AC Grounded
 with $1\ \mu\text{F}$ $V_p = 5\text{ V}$

NCP2820 Series

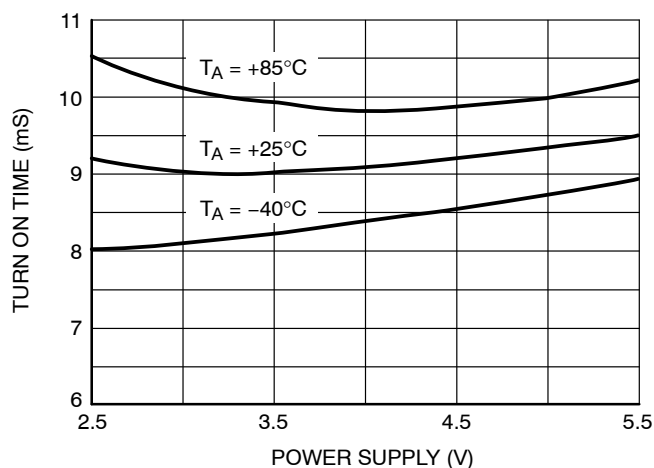

Figure 33. Turn on Time

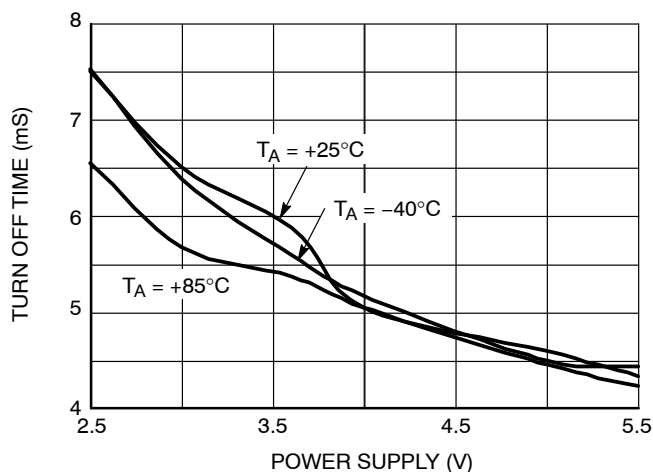

Figure 34. Turn off Time

DESCRIPTION INFORMATION

Detailed Description

The basic structure of the NCP2820 is composed of one analog pre-amplifier, a pulse width modulator and an H-bridge CMOS power stage. The first stage is externally configurable with gain-setting resistor R_i and the internal fixed feedback resistor R_f (the closed-loop gain is fixed by the ratios of these resistors) and the other stage is fixed. The load is driven differentially through two output stages.

The differential PWM output signal is a digital image of the analog audio input signal. The human ear is a band pass filter regarding acoustic waveforms, the typical values of which are 20 Hz and 20 kHz. Thus, the user will hear only the amplified audio input signal within the frequency range. The switching frequency and its harmonics are fully filtered. The inductive parasitic element of the loudspeaker helps to guarantee a superior distortion value.

Power Amplifier

The output PMOS and NMOS transistors of the amplifier have been designed to deliver the output power of the specifications without clipping. The channel resistance (R_{on}) of the NMOS and PMOS transistors is typically 0.4 Ω .

Turn On and Turn Off Transitions in the 9 Pin Flip-Chip Package (NCP2820)

In order to eliminate “pop and click” noises during transition, the output power in the load must not be established or cutoff suddenly. When a logic high is applied to the shutdown pin, the internal biasing voltage rises quickly and, 4 ms later, once the output DC level is around the common mode voltage, the gain is established slowly (5.0 ms). This method to turn on the device is optimized in terms of rejection of “pop and click” noises. Thus, the total turn on time to get full power to the load is 9 ms (typical).

The device has the same behavior when it is turned-off by a logic low on the shutdown pin. No power is delivered to the load 5 ms after a falling edge on the shutdown pin. Due to

the fast turn on and off times, the shutdown signal can be used as a mute signal as well.

Turn On and Turn Off Transitions in the 9 Pin Flip-Chip Package (NCP2820)

In the case of the NCP2820A, the sequences are the same as the NCP2820. Only the timing is different with 1 ms for the turn on and 500 μ s for the turn off sequence.

Turn On and Turn Off Transitions in the UDFN8

In the case of the UDFN8 package, the audio signal is established instantaneously after the rising edge on the shutdown pin. The audio is also suddenly cut once a low level is sent to the amplifier. This way to turn on and off the device in a very fast way also prevents from “pop & click” noise.

Shutdown Function

The device enters shutdown mode when the shutdown signal is low. During the shutdown mode, the DC quiescent current of the circuit does not exceed 1.5 μ A.

Current Breaker Circuit

The maximum output power of the circuit corresponds to an average current in the load of 820 mA.

In order to limit the excessive power dissipation in the load if a short-circuit occurs, a current breaker cell shuts down the output stage. The current in the four output MOS transistors are real-time controlled, and if one current exceeds the threshold set to 1.5 A, the MOS transistor is opened and the current is reduced to zero. As soon as the short-circuit is removed, the circuit is able to deliver the expected output power.

This patented structure protects the NCP2820. Since it completely turns off the load, it minimizes the risk of the chip overheating which could occur if a soft current limiting circuit was used.

APPLICATION INFORMATION

NCP2820 PWM Modulation Scheme

The NCP2820 uses a PWM modulation scheme with each output switching from 0 to the supply voltage. If $V_{in} = 0$ V outputs OUTM and OUTP are in phase and no current is flowing through the differential load. When a positive signal

is applied, OUTP duty cycle is greater than 50% and OUTM is less than 50%. With this configuration, the current through the load is 0 A most of the switching period and thus power losses in the load are lowered.

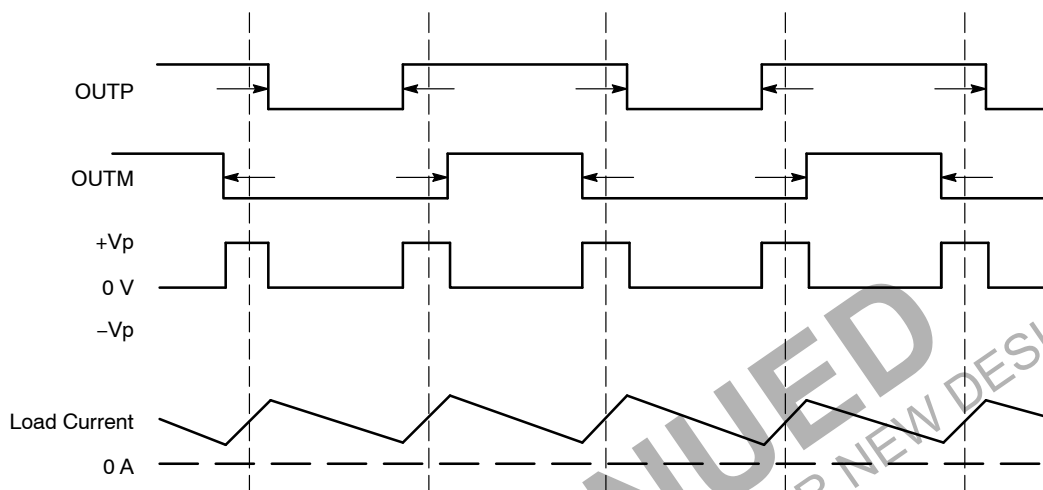

Figure 35. Output Voltage and Current Waveforms into an Inductive Loudspeaker DC Output Positive Voltage Configuration

Voltage Gain

The first stage is an analog amplifier. The second stage is a comparator: the output of the first stage is compared with a periodic ramp signal. The output comparator gives a pulse width modulation signal (PWM). The third and last stage is the direct conversion of the PWM signal with MOS transistors H-bridge into a powerful output signal with low impedance capability.

With an 8 Ω load, the total gain of the device is typically set to:

$$\frac{300 \text{ k}\Omega}{R_i}$$

Input Capacitor Selection (C_{in})

The input coupling capacitor blocks the DC voltage at the amplifier input terminal. This capacitor creates a high-pass filter with R_{in} , the cut-off frequency is given by

$$F_c = \frac{1}{2 \times \pi \times R_i \times C_i}$$

When using an input resistor set to 150 $\text{k}\Omega$, the gain configuration is 2 V/V. In such a case, the input capacitor selection can be from 10 nF to 1 μF with cutoff frequency values between 1 Hz and 100 Hz. The NCP2820 also includes a built in low pass filtering function. It's cut off frequency is set to 20 kHz.

Optional Output Filter

This filter is optional due to the capability of the speaker to filter by itself the high frequency signal. Nevertheless, the high frequency is not audible and filtered by the human ear.

An optional filter can be used for filtering high frequency signal before the speaker. In this case, the circuit consists of two inductors (15 μH) and two capacitors (2.2 μF) (Figure 36). The size of the inductors is linked to the output power requested by the application. A simplified version of this filter requires a 1 μF capacitor in parallel with the load, instead of two 2.2 μF connected to ground (Figure 37).

Cellular phones and portable electronic devices are great applications for Filterless Class-D as the track length between the amplifier and the speaker is short, thus, there is usually no need for an EMI filter. However, to lower radiated emissions as much as possible when used in filterless mode, a ferrite filter can often be used. Select a ferrite bead with the high impedance around 100 MHz and a very low DCR value in the audio frequency range is the best choice. The MPZ1608S221A1 from TDK is a good choice. The package size is 0603.

Optimum Equivalent Capacitance at Output Stage

If the optional filter described in the above section isn't selected. Cellular phones and wireless portable devices design normally put several Radio Frequency filtering capacitors and ESD protection devices between Filter less Class D outputs and loudspeaker. Those devices are usually connected between amplifier output and ground. In order to achieve the best sound quality, the optimum value of total equivalent capacitance between each output terminal to the ground should be less than or equal to 150 pF. This total equivalent capacitance consists of the radio frequency filtering capacitors and ESD protection device equivalent parasitic capacitance.

NCP2820 Series

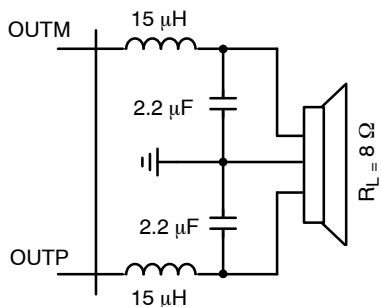

Figure 36. Advanced Optional Audio Output Filter

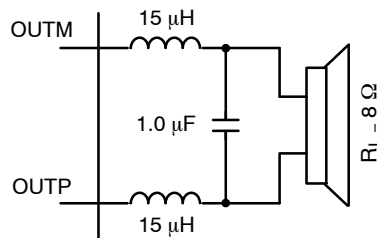

Figure 37. Optional Audio Output Filter

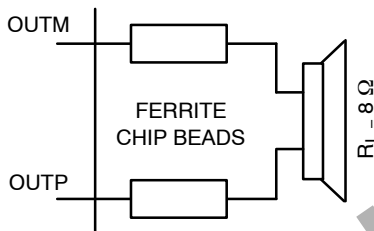

Figure 38. Optional EMI Ferrite Bead Filter

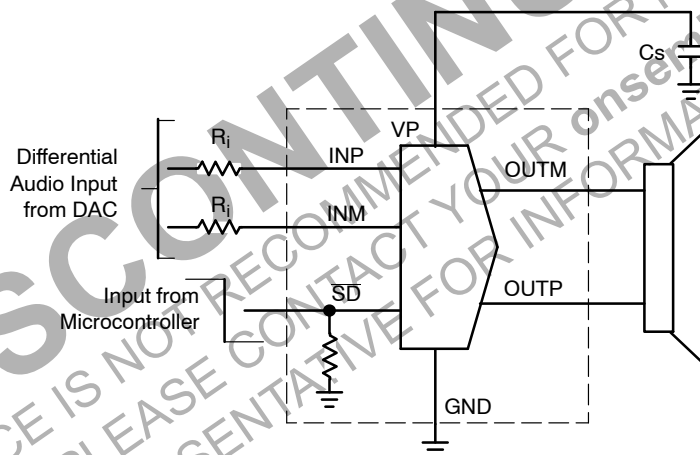

Figure 39. NCP2820 Application Schematic with Fully Differential Input Configuration

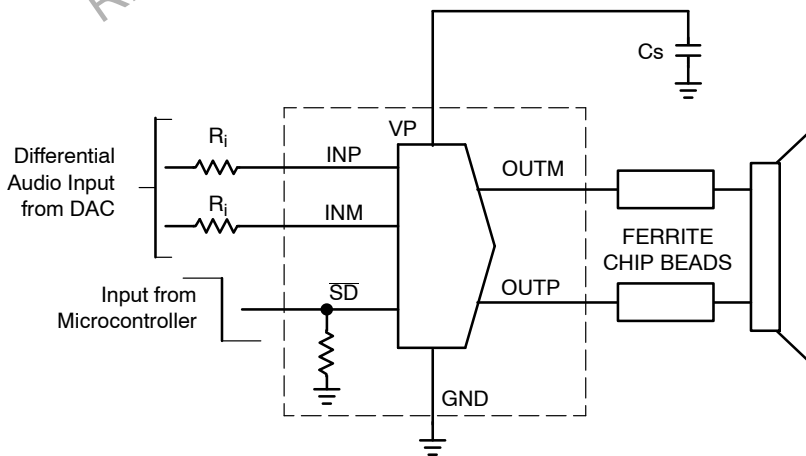

Figure 40. NCP2820 Application Schematic with Fully Differential Input Configuration and Ferrite Chip Beads as an Output EMI Filter

NCP2820 Series

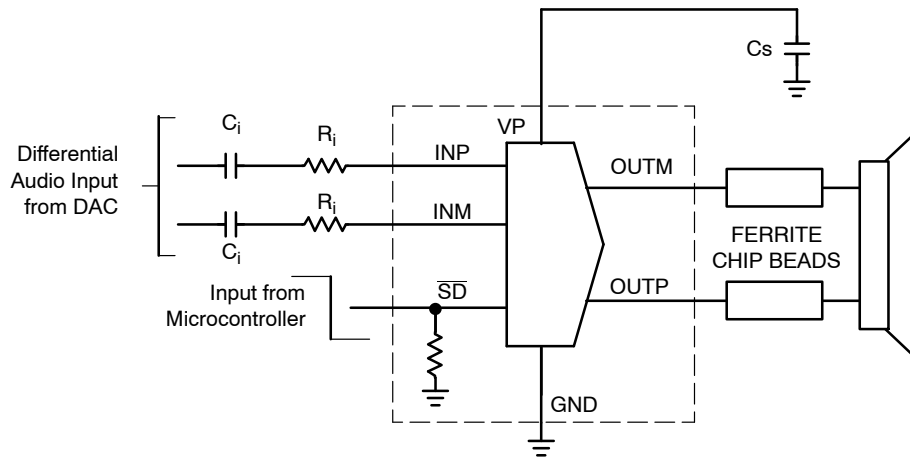

Figure 41. NCP2820 Application Schematic with Differential Input Configuration and High Pass Filtering Function

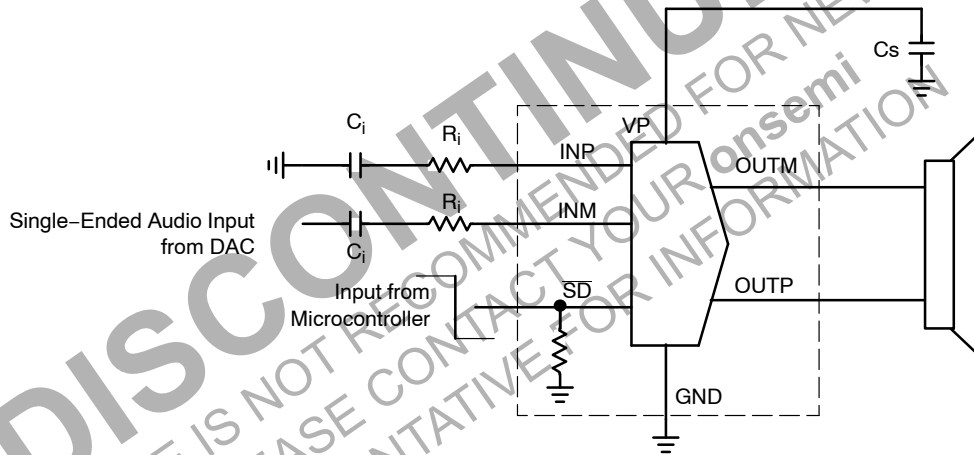

Figure 42. NCP2820 Application Schematic with Single Ended Input Configuration

NCP2820 Series

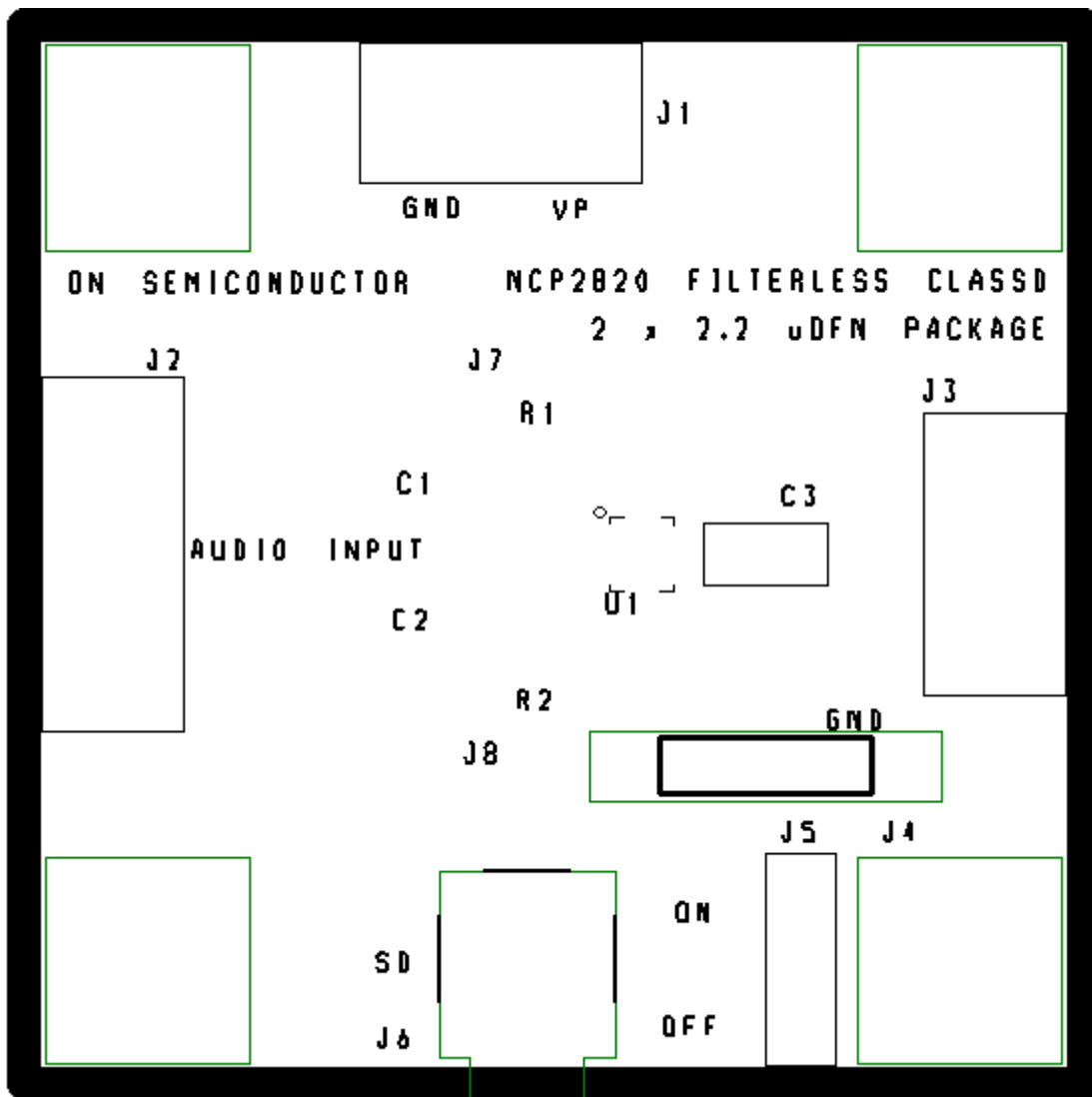

Figure 45. Silkscreen Layer of the UDFN8 Evaluation Board

PCB Layout Information

NCP2820 is suitable for low cost solution. In a very small package it gives all the advantages of a Class-D audio amplifier. The required application board is focused on low cost solution too. Due to its fully differential capability, the audio signal can only be provided by an input resistor. If a low pass filtering function is required, then an input coupling capacitor is needed. The values of these components determine the voltage gain and the bandwidth frequency. The battery positive supply voltage requires a good decoupling capacitor versus the expected distortion.

When the board is using Ground and Power planes with at least 4 layers, a single 4.7 μF filtering ceramic capacitor on the bottom face will give optimized performance.

A 1.0 μF low ESR ceramic capacitor can also be used with slightly degraded performances on the THD+N from 0.06% up to 0.2%.

In a two layers application, if both V_p pins are connected on the top layer, a single 4.7 μF decoupling capacitor will optimize the THD+N level.

The NCP2820 power audio amplifier can operate from 2.5 V until 5.5 V power supply. With less than 2% THD+N, it delivers 500 mW rms output power to a 8.0 Ω load at $V_p = 3.0$ V and 1.0 W rms output power at $V_p = 4.0$ V.

NCP2820 Series

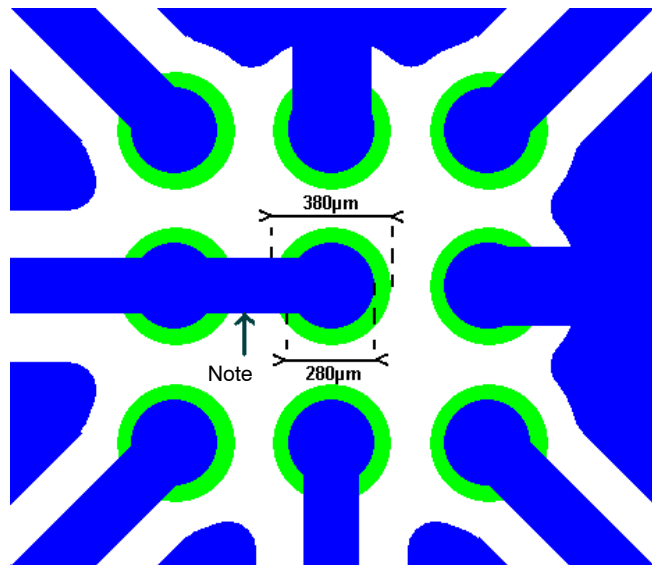

Figure 46. Top Layer of Two Layers Board Dedicated to the 9-Pin Flip-Chip Package

Note: This track between Vp pins is only needed when a 2 layers board is used. In case of a typical 4 or more layers, the use of laser vias in pad will optimize the THD+N floor. The demonstration board delivered by ON Semiconductor is a 4 Layers with Top, Ground, Power Supply and Bottom.

Bill of Materials

Item	Part Description	Ref	PCB Footprint	Manufacturer	Part Number
1	NCP2820 Audio Amplifier	U1			NCP2820
2	SMD Resistor 150 kΩ	R1, R2	0603	Vishay-Draloric	CRCW0603
3	Ceramic Capacitor 100 nF, 50 V, X7R	C1, C2	0603	TDK	C1608X7R1H104KT
4	Ceramic Capacitor 4.7 µF, 6.3 V, X5R	C3, C4	0603	TDK	C1608X5R0J475MT
5	PCB Footprint	J7, J8			
6	I/O connector. It can be plugged by MC-1,5/3-ST-3,81	J2		Phoenix Contact	MC-1,5/3-G
7	I/O connector. It can be plugged by BLZ5.08/2 (Weidmuller Reference)	J1, J3		Weidmuller	SL5.08/2/90B
8	Jumper Connector, 400 mils	J4		Harwin	D3082-B01
9	Jumper Header Vertical Mount 3*1, 2.54 mm.	J5		Tyco Electronics / AMP	5-826629-0

ORDERING INFORMATION

Device	Marking	Package	Shipping†
NCP2820FCT1G	MAQ	9-Pin Flip-Chip CSP (Pb-Free)	3000 / Tape & Reel T1 Orientation
NCP2820FCT2G	MAQ		3000 / Tape & Reel T2 Orientation
NCP2820AFCT2G	MBD		
NCP2820MUTBG	ZB	8 PIN UDFN 2x2.2 (Pb-Free)	3000 / Tape & Reel
NCV2820MUTBG*	AT		

†For information on tape and reel specifications, including part orientation and tape sizes, please refer to our Tape and Reel Packaging Specifications Brochure, BRD8011/D.

*NCV Prefix for Automotive and Other Applications Requiring Unique Site and Control Change Requirements; AEC-Q100 Qualified and PPAP Capable.

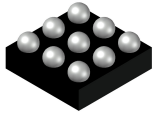

9 PIN FLIP-CHIP 1.45x1.45x0.596
CASE 499AL
ISSUE A

DATE 21 JUN 2022

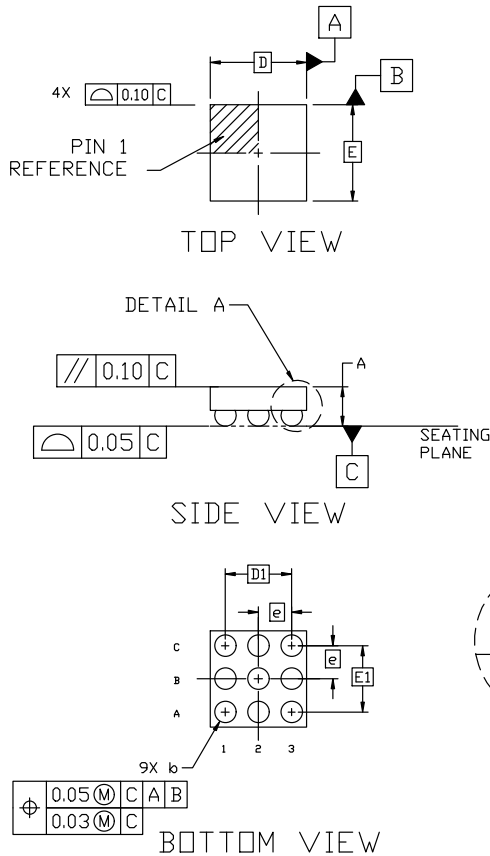

NOTES:

1. DIMENSIONING AND TOLERANCING PER ASME Y14.5M, 2009.
2. CONTROLLING DIMENSION: MILLIMETERS
3. DIMENSION b IS MEASURED AT THE MAXIMUM SOLDER BALL DIAMETER PARALLEL TO DATUM C.
4. COPLANARITY APPLIES TO THE SPHERICAL CROWNS OF THE SOLDER BALLS.
5. DATUM C, THE SEATING PLANE, IS DEFINED BY THE SPHERICAL CROWNS OF THE SOLDER BALLS.

DIM	MILLIMETERS		
	MIN.	NOM.	MAX.
A	0.541	0.596	0.651
A1	0.206	0.236	0.266
A2	0.335	0.360	0.385
b	0.289	0.319	0.349
D	1.450 BSC		
D1	1.000 BSC		
E	1.450 BSC		
E1	1.000 BSC		
e	0.50 BSC		

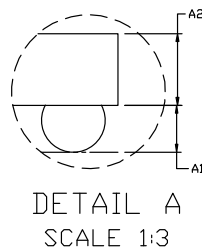

GENERIC MARKING DIAGRAM*

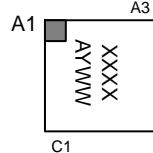

- XXXX = Specific Device Code
- A = Assembly Location
- Y = Year
- WW = Work Week
- G or ■ = Pb-Free Package

*This information is generic. Please refer to device data sheet for actual part marking. Pb-Free indicator, "G" or microdot "■", may or may not be present. Some products may not follow the Generic Marking.

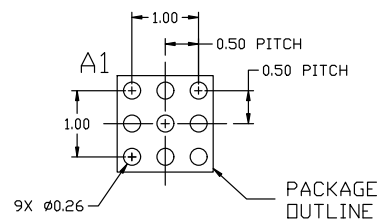

* For additional information on our Pb-Free strategy and soldering details, please download the ON Semiconductor Soldering and Mounting Techniques Reference Manual, SOLDERRM/D.

DOCUMENT NUMBER:	98AON19548D	Electronic versions are uncontrolled except when accessed directly from the Document Repository. Printed versions are uncontrolled except when stamped "CONTROLLED COPY" in red.
DESCRIPTION:	9 PIN FLIP-CHIP 1.45x1.45x0.596	PAGE 1 OF 1

onsemi and ONSEMI are trademarks of Semiconductor Components Industries, LLC dba onsemi or its subsidiaries in the United States and/or other countries. onsemi reserves the right to make changes without further notice to any products herein. onsemi makes no warranty, representation or guarantee regarding the suitability of its products for any particular purpose, nor does onsemi assume any liability arising out of the application or use of any product or circuit, and specifically disclaims any and all liability, including without limitation special, consequential or incidental damages. onsemi does not convey any license under its patent rights nor the rights of others.

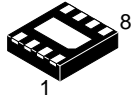

SCALE 4:1

UDFN8 2x2.2, 0.5P
CASE 506AV
ISSUE C

DATE 26 JUN 2013

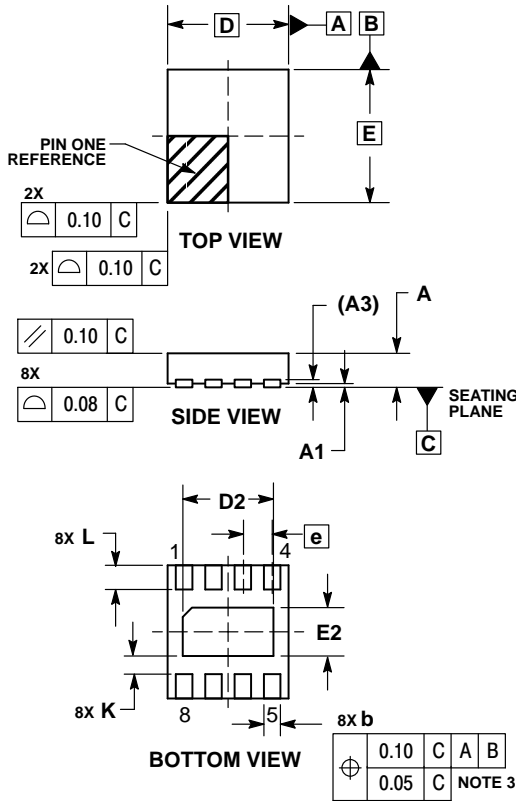

NOTES:

1. DIMENSIONING AND TOLERANCING PER ASME Y14.5M, 1994.
2. CONTROLLING DIMENSION: MILLIMETERS.
3. DIMENSION b APPLIES TO PLATED TERMINAL AND IS MEASURED BETWEEN 0.25 AND 0.30 mm FROM TERMINAL.
4. COPLANARITY APPLIES TO THE EXPOSED PAD AS WELL AS THE TERMINALS.

DIM	MILLIMETERS		
	MIN	NOM	MAX
A	0.45	0.50	0.55
A1	0.00	0.03	0.05
A3	0.127 REF		
b	0.20	0.25	0.30
D	2.00 BSC		
D2	1.40	1.50	1.60
E	2.20 BSC		
E2	0.70	0.80	0.90
e	0.50 BSC		
K	0.20	---	---
L	0.35	0.40	0.45

GENERIC
MARKING DIAGRAM*

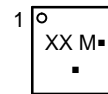

- XX = Specific Device Code
- M = Date Code
- = Pb-Free Device

*This information is generic. Please refer to device data sheet for actual part marking.
Pb-Free indicator, "G" or microdot "■", may or may not be present.

RECOMMENDED
SOLDERING FOOTPRINT*

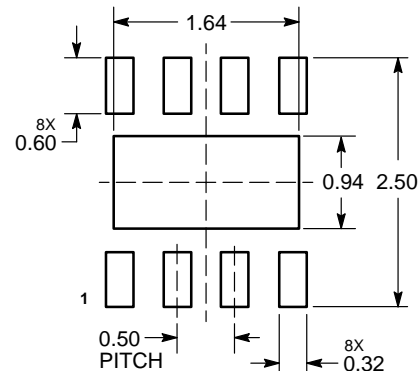

DIMENSIONS: MILLIMETERS

*For additional information on our Pb-Free strategy and soldering details, please download the onsemi Soldering and Mounting Techniques Reference Manual, SOLDERRM/D.

DOCUMENT NUMBER:	98AON21873D	Electronic versions are uncontrolled except when accessed directly from the Document Repository. Printed versions are uncontrolled except when stamped "CONTROLLED COPY" in red.
DESCRIPTION:	UDFN8, 2.0X2.2, 0.5P	PAGE 1 OF 1

onsemi and ONSEMI are trademarks of Semiconductor Components Industries, LLC dba onsemi or its subsidiaries in the United States and/or other countries. onsemi reserves the right to make changes without further notice to any products herein. onsemi makes no warranty, representation or guarantee regarding the suitability of its products for any particular purpose, nor does onsemi assume any liability arising out of the application or use of any product or circuit, and specifically disclaims any and all liability, including without limitation special, consequential or incidental damages. onsemi does not convey any license under its patent rights nor the rights of others.

onsemi, **Onsemi**, and other names, marks, and brands are registered and/or common law trademarks of Semiconductor Components Industries, LLC dba "**onsemi**" or its affiliates and/or subsidiaries in the United States and/or other countries. **onsemi** owns the rights to a number of patents, trademarks, copyrights, trade secrets, and other intellectual property. A listing of **onsemi**'s product/patent coverage may be accessed at www.onsemi.com/site/pdf/Patent-Marking.pdf. **onsemi** reserves the right to make changes at any time to any products or information herein, without notice. The information herein is provided "as-is" and **onsemi** makes no warranty, representation or guarantee regarding the accuracy of the information, product features, availability, functionality, or suitability of its products for any particular purpose, nor does **onsemi** assume any liability arising out of the application or use of any product or circuit, and specifically disclaims any and all liability, including without limitation special, consequential or incidental damages. Buyer is responsible for its products and applications using **onsemi** products, including compliance with all laws, regulations and safety requirements or standards, regardless of any support or applications information provided by **onsemi**. "Typical" parameters which may be provided in **onsemi** data sheets and/or specifications can and do vary in different applications and actual performance may vary over time. All operating parameters, including "Typicals" must be validated for each customer application by customer's technical experts. **onsemi** does not convey any license under any of its intellectual property rights nor the rights of others. **onsemi** products are not designed, intended, or authorized for use as a critical component in life support systems or any FDA Class 3 medical devices or medical devices with a same or similar classification in a foreign jurisdiction or any devices intended for implantation in the human body. Should Buyer purchase or use **onsemi** products for any such unintended or unauthorized application, Buyer shall indemnify and hold **onsemi** and its officers, employees, subsidiaries, affiliates, and distributors harmless against all claims, costs, damages, and expenses, and reasonable attorney fees arising out of, directly or indirectly, any claim of personal injury or death associated with such unintended or unauthorized use, even if such claim alleges that **onsemi** was negligent regarding the design or manufacture of the part. **onsemi** is an Equal Opportunity/Affirmative Action Employer. This literature is subject to all applicable copyright laws and is not for resale in any manner.

ADDITIONAL INFORMATION

TECHNICAL PUBLICATIONS:

Technical Library: www.onsemi.com/design/resources/technical-documentation
onsemi Website: www.onsemi.com

ONLINE SUPPORT: www.onsemi.com/support

For additional information, please contact your local Sales Representative at www.onsemi.com/support/sales