

# PCA9534A Remote 8-BIT I<sup>2</sup>C and SMBus Low-Power I/O Expander With Interrupt Output And Configuration Registers

## 1 Features

- Low standby current consumption of 1  $\mu$ A max
- I<sup>2</sup>C to Parallel port expander
- Open-drain active-low interrupt output
- Operating power-supply voltage range of 2.3 V to 5.5 V
- 5-V Tolerant I/O ports
- 400-kHz Fast I<sup>2</sup>C bus
- Three hardware address pins allow up to eight devices on the I<sup>2</sup>C/SMBus
- Allows up to 16 devices on the I<sup>2</sup>C/SMBus when used in conjunction with the [PCA9534](#)  
See [Section 5](#) for I<sup>2</sup>C Expander offerings
- Input and output configuration register
- Polarity inversion register
- Internal power-on reset
- Power-up with all channels configured as Inputs
- No glitch on power-up
- Noise filter on SCL and SDA inputs
- Latched outputs with high-current drive maximum capability for directly driving LEDs
- Latch-up performance exceeds 100 mA Per JESD 78, Class II
- ESD protection exceeds JESD 22
  - 2000-V Human-body Model (A114-A)
  - 200-V Machine Model (A115-A)
  - 1000-V Charged-device model (C101)

## 2 Description

This 8-bit I/O expander for the two-line bidirectional bus (I<sup>2</sup>C) is designed for 2.3-V to 5.5-V V<sub>CC</sub> operation. It provides general-purpose remote I/O expansion for most microcontroller families via the I<sup>2</sup>C interface [serial clock (SCL), serial data (SDA)].

The PCA9534A consists of one 8-bit configuration (input or output selection), input port, output port, and polarity inversion (active high or active low) register. At power on, the I/Os are configured as inputs. However, the system master can enable the I/Os as either inputs or outputs by writing to the I/O configuration bits. The data for each input or output is kept in the corresponding input or output register. The polarity of the input port register can be inverted with the polarity inversion register. All registers can be read by the system master.

The system master can reset the PCA9534A in the event of a timeout or other improper operation by utilizing the power-on reset feature, which puts the registers in their default state and initializes the I<sup>2</sup>C/SMBus state machine.

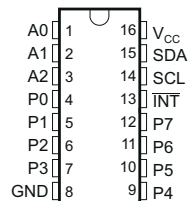
The PCA9534A open-drain interrupt ( $\overline{\text{INT}}$ ) output is activated when any input state differs from its corresponding input port register state and is used to indicate to the system master that an input state has changed.

### Device Information

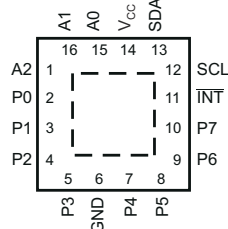
PART NUMBER	PACKAGE <sup>(1)</sup>	BODY SIZE (NOM)
PCA9534A	SSOP (16)	6.20 mm × 5.30 mm
	VQFN (16)	4.00 mm × 4.00 mm
	QFN (16)	3.00 mm × 3.00 mm

(1) For all available packages, see the orderable addendum at the end of the datasheet.

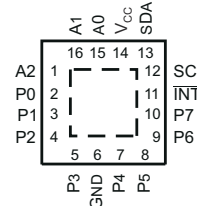
DB, DBQ, DGV, DW, OR PW PACKAGE  
(TOP VIEW)



RGV PACKAGE  
(TOP VIEW)



RGT PACKAGE  
(TOP VIEW)



## Table of Contents

<b>1 Features</b> .....	<b>1</b>	<b>8 Parameter Measurement Information</b> .....	<b>12</b>
<b>2 Description</b> .....	<b>1</b>	<b>9 Detailed Description</b> .....	<b>15</b>
<b>3 Revision History</b> .....	<b>2</b>	9.1 Functional Block Diagram.....	15
<b>4 Description (Continued)</b> .....	<b>3</b>	9.2 Device Functional Modes.....	16
<b>5 Device Comparison Table</b> .....	<b>4</b>	9.3 Programming.....	17
<b>6 Pin Configuration and Functions</b> .....	<b>5</b>	<b>10 Application Information Disclaimer</b> .....	<b>23</b>
<b>7 Specifications</b> .....	<b>6</b>	10.1 Application Information.....	23
7.1 Absolute Maximum Ratings.....	6	<b>11 Power Supply Recommendations</b> .....	<b>25</b>
7.2 ESD Ratings.....	6	11.1 Power-On Reset Requirements.....	25
7.3 Recommended Operating Conditions.....	6	<b>12 Device and Documentation Support</b> .....	<b>27</b>
7.4 Thermal Resistance Characteristics.....	6	12.1 Trademarks.....	27
7.5 Electrical Characteristics.....	7	12.2 Electrostatic Discharge Caution.....	27
7.6 I <sup>2</sup> C Interface Timing Requirements.....	8	12.3 Glossary.....	27
7.7 Switching Characteristics.....	8	<b>13 Mechanical, Packaging, and Orderable Information</b> .....	<b>27</b>
7.8 Typical Characteristics.....	9		

## 3 Revision History

Changes from Revision I (June 2014) to Revision J (March 2021)	Page
• Moved the "Storage temperature range" to the <i>Absolute Maximum Ratings</i> .....	6
• Moved the "Package thermal impedance" to the <i>Thermal Resistance Characteristic</i> .....	6
• Changed the V <sub>IH</sub> High-level input voltage (SDL, SDA) Max value From: 5.5 V To: V <sub>CC</sub> in the <i>Recommended Operating Conditions</i> .....	6
• Changed the V <sub>IH</sub> High-level input voltage (A0, A1, A2, P7–P0) MIN value From: 2 V To: V <sub>CC</sub> in the <i>Recommended Operating Conditions</i> .....	6
• Changed the V <sub>IL</sub> Low-level input voltage (A0, A1, A2, P7–P0) MAX value From: 0.8 V To: 0.3 x V <sub>CC</sub> in the <i>Recommended Operating Conditions</i> .....	6
• Added the <i>Thermal Resistance Characteristics</i> .....	6
• Changed the V <sub>PORR</sub> row in the <i>Electrical Characteristics</i> .....	7
• Added the V <sub>PORF</sub> row in the <i>Electrical Characteristics</i> .....	7
• Changed the I <sub>CC</sub> Standby mode values in the <i>Electrical Characteristics</i> .....	7
• Changed the C <sub>i</sub> SCL Max value From: 5 pF To: 8 pF in the <i>Electrical Characteristics</i> .....	7
• Changed the C <sub>io</sub> SDA Max value From: 6.5 pF To: 9.5 pF in the <i>Electrical Characteristics</i> .....	7
• Changed the t <sub>pv</sub> Output data valid MAX values From: 200 ns To 350 ns in the <i>Swirching Characteristics</i> .....	8
• Changed the <i>Typical Characteristics</i> graphs.....	9
• Changed the <i>Power Supply Recommendations</i> .....	25
<hr/>	
Changes from Revision H (June 2010) to Revision I (June 2014)	Page
• Added Interrupt Errata section. ....	17
• Deleted the 100 kΩ resistor at V <sub>CC</sub> .....	23

## 4 Description (Continued)

The PCA9534A and PCA9534 are identical, except for their fixed I<sup>2</sup>C address. This allows for up to 16 of these devices (8 of each) on the same I<sup>2</sup>C bus.

$\overline{\text{INT}}$  can be connected to the interrupt input of a microcontroller. By sending an interrupt signal on this line, the remote I/O can inform the microcontroller if there is incoming data on its ports without having to communicate via the I<sup>2</sup>C bus. Thus, the PCA9534A can remain a simple slave device.

The device's outputs (latched) have high-current drive capability for directly driving LEDs. It has low current consumption.

Three hardware pins (A0, A1, and A2) are used to program and vary the fixed I<sup>2</sup>C address and allow up to eight devices to share the same I<sup>2</sup>C bus or SMBus.

The PCA9534A is pin-to-pin and I<sup>2</sup>C address compatible with the PCF8574A. However, software changes are required due to the enhancements in the PCA9534A over the PCF8574A.

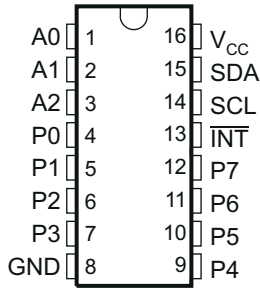
The PCA9534A is a low-power version of the PCA9554A. The only difference between the PCA9534A and PCA9554A is that the PCA9534A eliminates an internal I/O pullup resistor, which dramatically reduces power consumption in the standby mode when the I/Os are held low.

## 5 Device Comparison Table

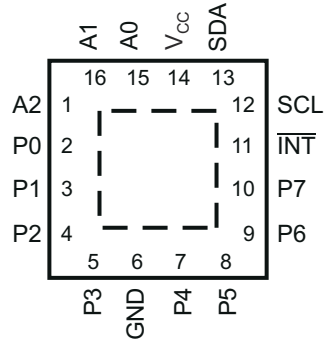
DEVICE	MAX FREQUENCY	I <sup>2</sup> C ADDRESSES	V <sub>CC</sub> RANGE	NO. OF GPIOs	INTERRUPT OUTPUT	RESET INPUT	CONFIGURATION REGISTERS	5-V TOLERANT	PUSH-PULL I/O TYPE	OPEN-DRAIN I/O TYPE	COMMENT
TCA6408	400	0100 00x	1.65 to 5.5	8	Yes	Yes	Yes	Yes	Yes	No	Power on reset, t <sub>f</sub> (fall time) > 100 ms and t <sub>r</sub> (ramp time) < 10 ms
TCA6408	400	0100 00x	1.65 to 5.5	8	Yes	Yes	Yes	Yes	Yes	No	Unrestricted power on reset ramp/fall time. Both t <sub>f</sub> (fall time) and TRT (ramp time) can be between 0.1 ms and 2000 ms
TCA6416	400	0100 00x	1.65 to 5.5	16	Yes	Yes	Yes	Yes	Yes	No	Power on reset, t <sub>f</sub> (fall time) > 100 ms and TRT (ramp time) < 10 ms
TCA6416 A	400	0100 00x	1.65 to 5.5	16	Yes	Yes	Yes	Yes	Yes	No	Unrestricted power on reset ramp/fall time. Both t <sub>f</sub> (fall time) and TRT (ramp time) can be between 0.1 ms and 2000ms
TCA6424	400	0100 00x	1.65 to 5.5	24	Yes	Yes	Yes	Yes	Yes	No	Power on reset, t <sub>f</sub> (fall time) > 100 ms and TRT (ramp time) < 10 ms
TCA9535	400	0100 xxx	1.65 to 5.5	16	Yes	No	Yes	Yes	Yes	No	
TCA9539	400	1110 1xx	1.65 to 5.5	16	Yes	Yes	Yes	Yes	Yes	No	
TCA9555	400	0100 xxx	1.65 to 5.5	16	Yes	No	Yes	Yes	Yes	No	
PCA6107	400	0011 xxx	2.3 to 5.5	8	Yes	Yes	Yes	Yes	Yes P1—P7 bits	Yes P0 bit	One open drain output; eight push pull outputs
PCA9534	400	0100 xxx	2.3 to 5.5	8	Yes	No	Yes	Yes	Yes	No	PCA9534 has a different slave address as the PCA9534A, allowing up to 16 devices '9534 type devices on the same I <sup>2</sup> C bus
PCA9534 A	400	0111 xxx	2.3 to 5.5	8	Yes	No	Yes	Yes	Yes	No	PCA9534A has a different slave address as the PCA9534, allowing up to 16 devices '9534 type devices on the same I <sup>2</sup> C bus
PCA9535	400	0100 xxx	2.3 to 5.5	16	Yes	No	Yes	Yes	Yes	No	
PCA9536	400	1000 001	2.3 to 5.5	4	No	No	Yes	Yes	Yes	No	
PCA9538	400	1110 0xx	2.3 to 5.5	8	Yes	Yes	Yes	Yes	Yes	No	
PCA9539	400	1110 1xx	2.3 to 5.5	16	Yes	Yes	Yes	Yes	Yes	No	
PCA9554	400	0100 xxx	2.3 to 5.5	8	Yes	No	Yes	Yes	Yes	No	
PCA9554 A	400	0111 xxx	2.3 to 5.5	8	Yes	No	Yes	Yes	Yes	No	
PCA9555	400	0100 xxx	2.3 to 5.5	16	Yes	No	Yes	Yes	Yes	No	
PCA9557	400	0011 xxx	2.3 to 5.5	8	No	Yes	Yes	Yes	Yes	Yes	
PCF8574	400	0100 xxx	2.5 to 6.0	8	Yes	No	No	Yes	Yes	No	PCA8574 has a different slave address as the PCA8574A, allowing up to 16 devices '9534 type devices on the same I <sup>2</sup> C bus
PCF8574 A	400	0111 xxx	2.5 to 6.0	8	Yes	No	No	Yes	Yes	No	PCA8574A has a different slave address as the PCA8574, allowing up to 16 devices '9534 type devices on the same I <sup>2</sup> C bus
PCF8575	400	0100 xxx	2.5 to 5.5	16	Yes	No	No	Yes	Yes	No	
PCF8575 C	400	0100 xxx	4.5 to 5.5	16	Yes	No	No	Yes	No	Yes	

## 6 Pin Configuration and Functions

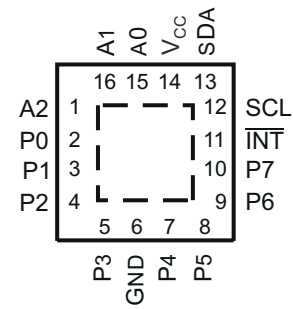
**DB, DBQ, DGV, DW, OR PW PACKAGE  
(TOP VIEW)**



**RGV PACKAGE  
(TOP VIEW)**



**RGT PACKAGE  
(TOP VIEW)**



**Table 6-1. Pin Functions**

NAME	PIN		DESCRIPTION
	QSOP (DBQ), SOIC (DW), SSOP (DB), TSSOP (PW), AND TVSOP (DGV)	QFN (RGT) AND QFN (RGV)	
A0	1	15	Address input. Connect directly to V <sub>CC</sub> or ground.
A1	2	16	Address input. Connect directly to V <sub>CC</sub> or ground.
A2	3	1	Address input. Connect directly to V <sub>CC</sub> or ground.
P0	4	2	P-port input/output. Push-pull design structure.
P1	5	3	P-port input/output. Push-pull design structure.
P2	6	4	P-port input/output. Push-pull design structure.
P3	7	5	P-port input/output. Push-pull design structure.
GND	8	6	Ground
P4	9	7	P-port input/output. Push-pull design structure.
P5	10	8	P-port input/output. Push-pull design structure.
P6	11	9	P-port input/output. Push-pull design structure.
P7	12	10	P-port input/output. Push-pull design structure.
INT	13	11	Interrupt output. Connect to V <sub>CC</sub> through a pullup resistor.
SCL	14	12	Serial clock bus. Connect to V <sub>CC</sub> through a pullup resistor.
SDA	15	13	Serial data bus. Connect to V <sub>CC</sub> through a pullup resistor.
V <sub>CC</sub>	16	14	Supply voltage

## 7 Specifications

### 7.1 Absolute Maximum Ratings

over operating free-air temperature range (unless otherwise noted) <sup>(1)</sup>

		MIN	MAX	UNIT
V <sub>CC</sub>	Supply voltage range	-0.5	6	V
V <sub>I</sub>	Input voltage range <sup>(2)</sup>	-0.5	6	V
V <sub>O</sub>	Output voltage range <sup>(2)</sup>	-0.5	6	V
I <sub>IK</sub>	Input clamp current	V <sub>I</sub> < 0	-20	mA
I <sub>OK</sub>	Output clamp current	V <sub>O</sub> < 0	-20	mA
I <sub>IOK</sub>	Input/output clamp current	V <sub>O</sub> < 0 or V <sub>O</sub> > V <sub>CC</sub>	±20	mA
I <sub>OL</sub>	Continuous output low current	V <sub>O</sub> = 0 to V <sub>CC</sub>	50	mA
I <sub>OH</sub>	Continuous output high current	V <sub>O</sub> = 0 to V <sub>CC</sub>	-50	mA
I <sub>CC</sub>	Continuous current through GND		-250	mA
	Continuous current through V <sub>CC</sub>		160	
T <sub>stg</sub>	Storage temperature range	-65	150	°C

- (1) Stresses beyond those listed under "absolute maximum ratings" may cause permanent damage to the device. These are stress ratings only, and functional operation of the device at these or any other conditions beyond those indicated under "recommended operating conditions" is not implied. Exposure to absolute-maximum-rated conditions for extended periods may affect device reliability.
- (2) The input negative-voltage and output voltage ratings may be exceeded if the input and output current ratings are observed.

### 7.2 ESD Ratings

			MIN	MAX	UNIT
V <sub>(ESD)</sub>	Electrostatic discharge	Human body model (HBM), per ANSI/ESDA/JEDEC JS-001, all pins <sup>(1)</sup>	0	2000	V
		Charged device model (CDM), per JEDEC specification JESD22-C101, all pins <sup>(2)</sup>	0	1000	

- (1) JEDEC document JEP155 states that 500-V HBM allows safe manufacturing with a standard ESD control process.
- (2) JEDEC document JEP157 states that 250-V CDM allows safe manufacturing with a standard ESD control process.

### 7.3 Recommended Operating Conditions

		MIN	MAX	UNIT
V <sub>CC</sub>	Supply voltage	2.3	5.5	V
V <sub>IH</sub>	High-level input voltage	SCL, SDA	0.7 × V <sub>CC</sub>	V <sub>CC</sub>
		A2–A0, P7–P0	0.7 × V <sub>CC</sub>	5.5
V <sub>IL</sub>	Low-level input voltage	SCL, SDA	-0.5	0.3 × V <sub>CC</sub>
		A2–A0, P7–P0	-0.5	0.3 × V <sub>CC</sub>
I <sub>OH</sub>	High-level output current	P7–P0	-10	mA
I <sub>OL</sub>	Low-level output current	P7–P0	25	mA
T <sub>A</sub>	Operating free-air temperature	-40	85	°C

### 7.4 Thermal Resistance Characteristics

THERMAL METRIC <sup>(1)</sup>		PCA9535							UNIT
		DB (SSOP)	DBQ (SSOP)	DVG (TVSOP)	DW (SOIC)	PW (TSSOP)	RGT (VQFN)	RVE (VQFN)	
		16 Pins	16 Pins	16 Pins	16 Pins	16 Pins	16 Pins	16 Pins	
R <sub>θJA</sub>	Junction-to-ambient thermal resistance	82	90	86	92.2	122	63.2	51	°C/W

- (1) For more information about traditional and new thermal metrics, see the [Semiconductor and IC package thermal metrics](#) application report.

## 7.5 Electrical Characteristics

over operating free-air temperature range (unless otherwise noted)

PARAMETER		TEST CONDITIONS	V <sub>CC</sub>	MIN	TYP <sup>(1)</sup>	MAX	UNIT		
V <sub>IK</sub>	Input diode clamp voltage	I <sub>I</sub> = -18 mA	2.3 V to 5.5 V	-1.2			V		
V <sub>PORR</sub>	Power-on reset voltage, V <sub>CC</sub> rising	V <sub>I</sub> = V <sub>CC</sub> or GND, I <sub>O</sub> = 0			1.2	1.5	V		
V <sub>PORF</sub>	Power-on reset voltage, V <sub>CC</sub> falling	V <sub>I</sub> = V <sub>CC</sub> or GND, I <sub>O</sub> = 0		0.75	1				
V <sub>OH</sub>	P-port high-level output voltage <sup>(2)</sup>	I <sub>OH</sub> = -8 mA	2.3 V	1.8			V		
			3 V	2.6					
			4.5 V	4.1					
			4.75 V	4.1					
		I <sub>OH</sub> = -10 mA	2.3 V	1.7					
			3 V	2.5					
			4.5 V	4					
			4.75 V	4					
I <sub>OL</sub>	SDA	V <sub>OL</sub> = 0.4 V	2.3 V to 5.5 V	3	8		mA		
	P port <sup>(3)</sup>	V <sub>OL</sub> = 0.5 V	2.3 V	8	10				
			3 V	8	14				
			4.5 V	8	17				
			4.75 V	8	35				
		V <sub>OL</sub> = 0.7 V	2.3 V	10	13				
			3 V	10	19				
			4.5 V	10	24				
			4.75 V	10	45				
	INT	V <sub>OL</sub> = 0.4 V	2.3 V to 5.5 V	3	10				
	I <sub>I</sub>	SCL, SDA	V <sub>I</sub> = V <sub>CC</sub> or GND	2.3 V to 5.5 V				±1	μA
		A2–A0						±1	
I <sub>IH</sub>	P port	V <sub>I</sub> = V <sub>CC</sub>	2.3 V to 5.5 V			1	μA		
I <sub>IL</sub>	P port	V <sub>I</sub> = GND	2.3 V to 5.5 V			-1	μA		
I <sub>CC</sub>	Operating mode	V <sub>I</sub> = V <sub>CC</sub> or GND, I <sub>O</sub> = 0, I/O = inputs, f <sub>scl</sub> = 400 kHz	5.5 V		104	175	μA		
			3.6 V		50	90			
			2.7 V		20	65			
			5.5 V		60	150			
			3.6 V		15	40			
			2.7 V		8	20			
	Standby mode	V <sub>I</sub> = GND, I <sub>O</sub> = 0, I/O = inputs, f <sub>scl</sub> = 0 kHz	5.5 V		1.5	8.7			
			3.6 V		0.9	4			
			2.7 V		0.6	3			
			5.5 V						
			3.6 V						
			2.7 V						
ΔI <sub>CC</sub>	Additional current in standby mode	One input at V <sub>CC</sub> - 0.6 V, Other inputs at V <sub>CC</sub> or GND	2.3 V to 5.5 V			1.5	mA		
		All LED I/Os at V <sub>I</sub> = 4.3 V, f <sub>scl</sub> = 0 kHz	5.5 V			1			
C <sub>I</sub>	SCL	V <sub>I</sub> = V <sub>CC</sub> or GND	2.3 V to 5.5 V		4	8	pF		
C <sub>io</sub>	SDA	V <sub>IO</sub> = V <sub>CC</sub> or GND	2.3 V to 5.5 V		5.5	9.5	pF		
	P port				8	9.5			

(1) All typical values are at nominal supply voltage (2.5-V, 3.3-V, or 5-V V<sub>CC</sub>) and T<sub>A</sub> = 25°C.

(2) The total current sourced by all I/Os must be limited to 85 mA.

(3) Each I/O must be externally limited to a maximum of 25 mA, and the P port (P7–P0) must be limited to a maximum current of 200 mA.

## 7.6 I<sup>2</sup>C Interface Timing Requirements

over operating free-air temperature range (unless otherwise noted) (see [Figure 8-1](#))

		STANDARD MODE I <sup>2</sup> C BUS		FAST MODE I <sup>2</sup> C BUS		UNIT		
		MIN	MAX	MIN	MAX			
$f_{scl}$	I <sup>2</sup> C clock frequency	0	100	0	400	kHz		
$t_{sch}$	I <sup>2</sup> C clock high time	4		0.6		μs		
$t_{scl}$	I <sup>2</sup> C clock low time	4.7		1.3		μs		
$t_{sp}$	I <sup>2</sup> C spike time		50		50	ns		
$t_{sds}$	I <sup>2</sup> C serial-data setup time	250		100		ns		
$t_{sdh}$	I <sup>2</sup> C serial-data hold time	0		0		ns		
$t_{icr}$	I <sup>2</sup> C input rise time		1000	$20 + 0.1C_b$ (1)	300	ns		
$t_{icf}$	I <sup>2</sup> C input fall time		300	$20 + 0.1C_b$ (1)	300	ns		
$t_{ocf}$	I <sup>2</sup> C output fall time	10-pF to 400-pF bus	300	$20 + 0.1C_b$ (1)	300	ns		
$t_{buf}$	I <sup>2</sup> C bus free time between stop and start	4.7		1.3		μs		
$t_{sts}$	I <sup>2</sup> C start or repeated start condition setup	4.7		0.6		μs		
$t_{sth}$	I <sup>2</sup> C start or repeated start condition hold	4		0.6		μs		
$t_{sps}$	I <sup>2</sup> C stop condition setup	4		0.6		μs		
$t_{vd(data)}$	Valid data time	SCL low to SDA output valid		300	50	ns		
$t_{vd(ack)}$	Valid data time of ACK condition	ACK signal from SCL low to SDA (out) low		0.3	3.45	0.1	0.9	μs
$C_b$	I <sup>2</sup> C bus capacitive load		400		400	ns		

(1)  $C_b$  = total capacitive of one bus in pF

## 7.7 Switching Characteristics

over operating free-air temperature range (unless otherwise noted) (see [Figure 8-2](#) and [Figure 8-3](#))

PARAMETER		FROM (INPUT)	TO (OUTPUT)	STANDARD MODE I <sup>2</sup> C BUS		FAST MODE I <sup>2</sup> C BUS		UNIT
				MIN	MAX	MIN	MAX	
$t_{iv}$	Interrupt valid time	P port	INT		4		4	μs
$t_{ir}$	Interrupt reset delay time	SCL	$\bar{INT}$		4		4	μs
$t_{pv}$	Output data valid	SCL	P7–P0		350		350	ns
$t_{ps}$	Input data setup time	P port	SCL	100		100		ns
$t_{ph}$	Input data hold time	P port	SCL	1		1		μs



## 7.8 Typical Characteristics

$T_A = 25^\circ\text{C}$  (unless otherwise noted)

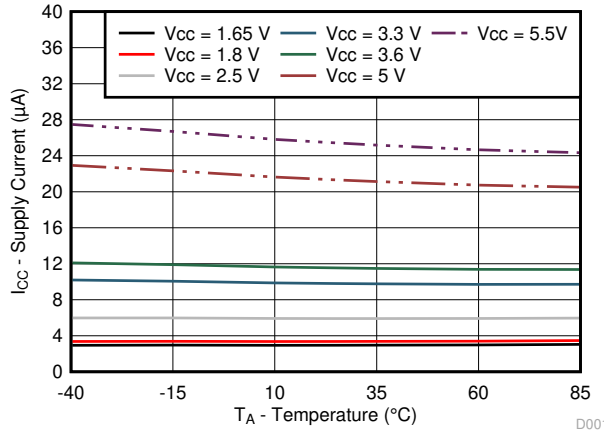


Figure 7-1. Supply Current vs Temperature for Different Supply Voltage ( $V_{CC}$ )

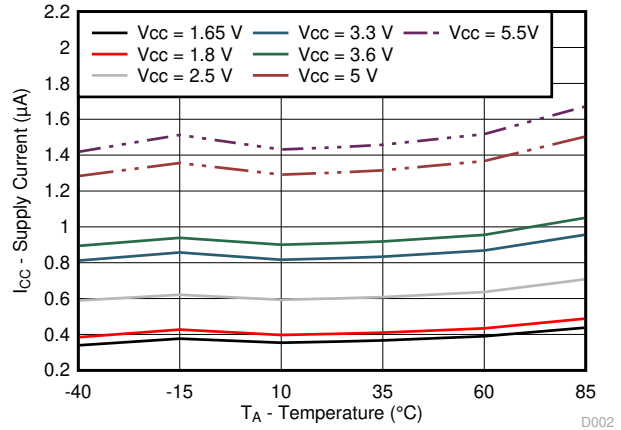


Figure 7-2. Standby Supply Current vs Temperature for Different Supply Voltage ( $V_{CC}$ )

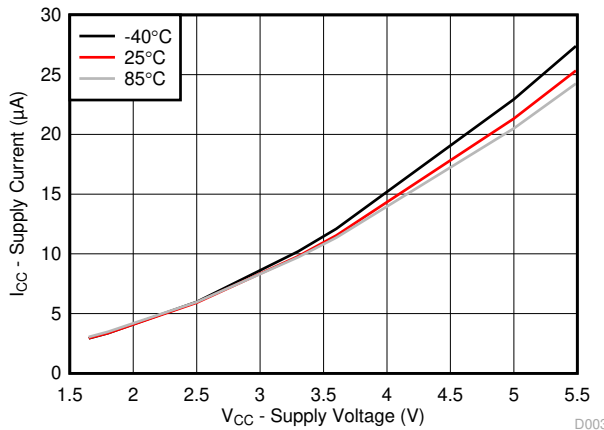


Figure 7-3. Supply Current vs Supply Voltage for Different Temperature ( $T_A$ )

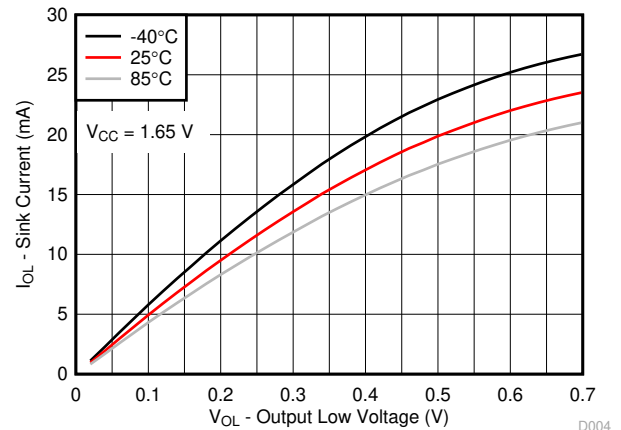


Figure 7-4. I/O Sink Current vs Output Low Voltage for Different Temperature ( $T_A$ ) for  $V_{CC} = 1.65\text{ V}$

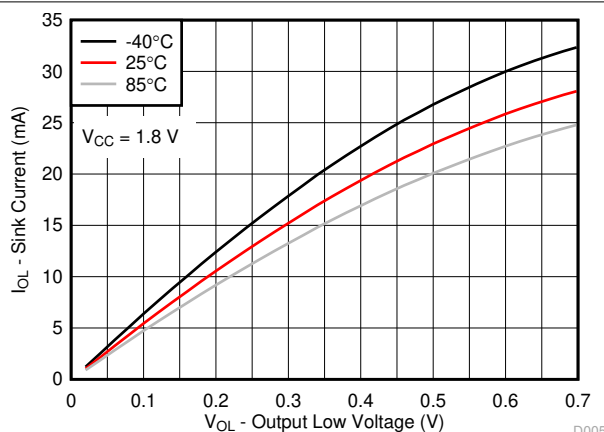


Figure 7-5. I/O Sink Current vs Output Low Voltage for Different Temperature ( $T_A$ ) for  $V_{CC} = 1.8\text{ V}$

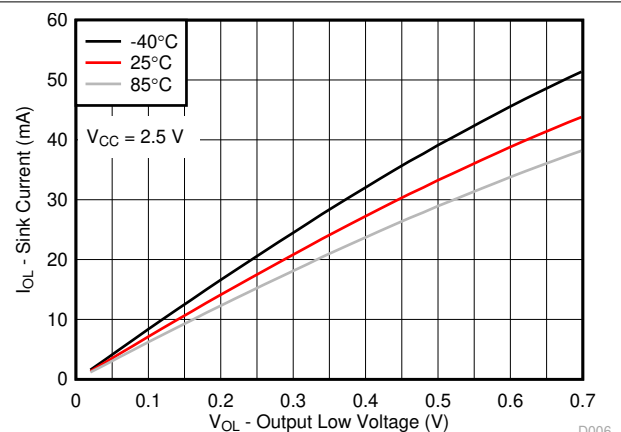


Figure 7-6. I/O Sink Current vs Output Low Voltage for Different Temperature ( $T_A$ ) for  $V_{CC} = 2.5\text{ V}$

## 7.8 Typical Characteristics (continued)

T<sub>A</sub> = 25°C (unless otherwise noted)

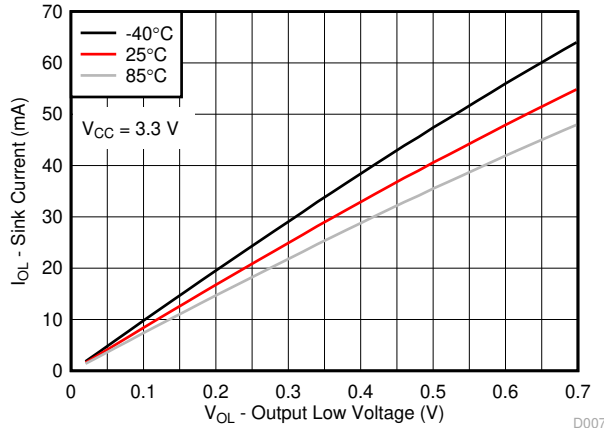


Figure 7-7. I/O Sink Current vs Output Low Voltage for Different Temperature (T<sub>A</sub>) for V<sub>CC</sub> = 3.3 V

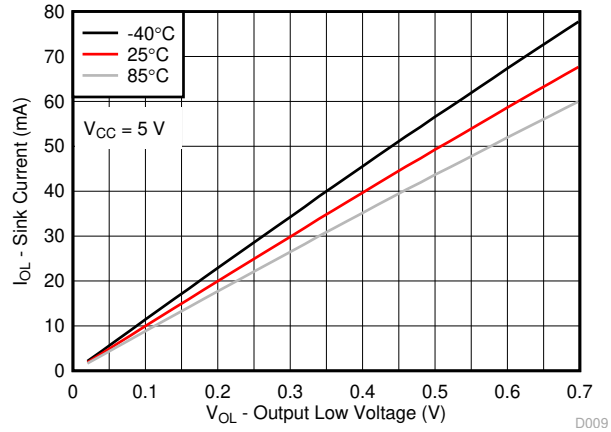


Figure 7-8. I/O Sink Current vs Output Low Voltage for Different Temperature (T<sub>A</sub>) for V<sub>CC</sub> = 5 V

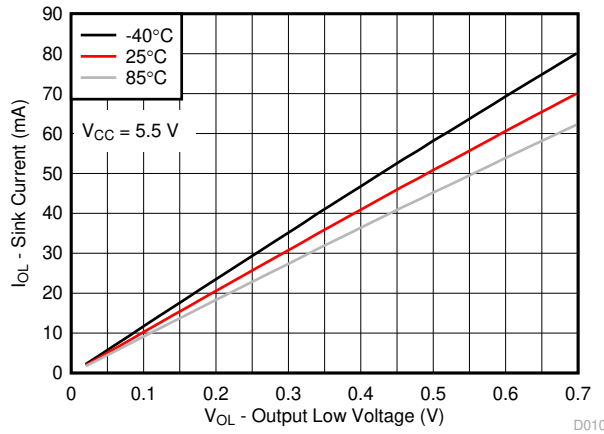


Figure 7-9. I/O Sink Current vs Output Low Voltage for Different Temperature (T<sub>A</sub>) for V<sub>CC</sub> = 5.5 V

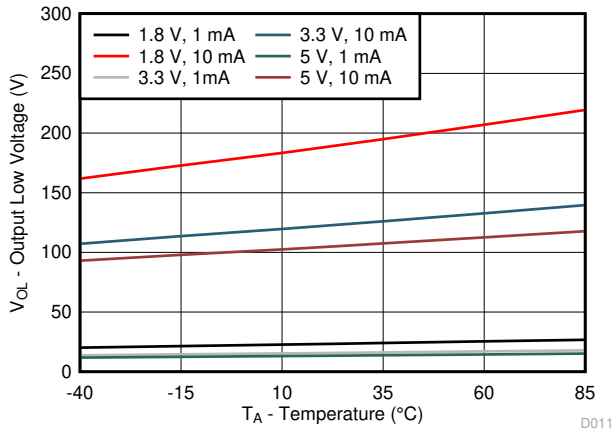


Figure 7-10. I/O Low Voltage vs Temperature for Different V<sub>CC</sub> and I<sub>OL</sub>

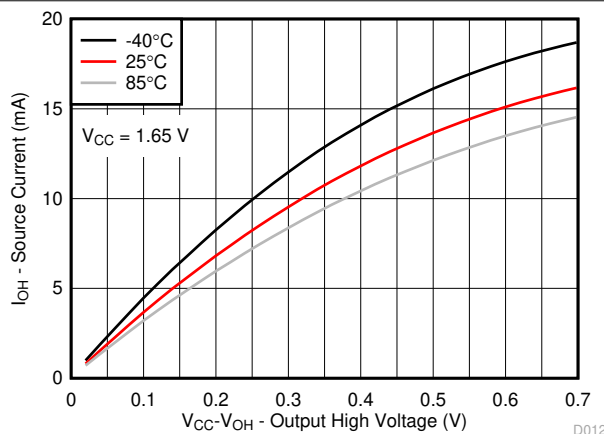


Figure 7-11. I/O Source Current vs Output High Voltage for Different Temperature (T<sub>A</sub>) for V<sub>CC</sub> = 1.65 V

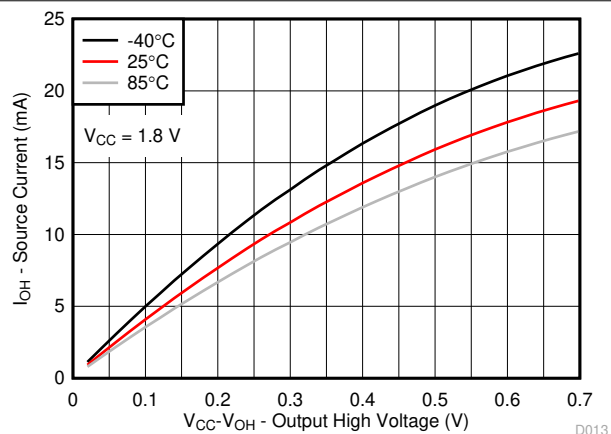
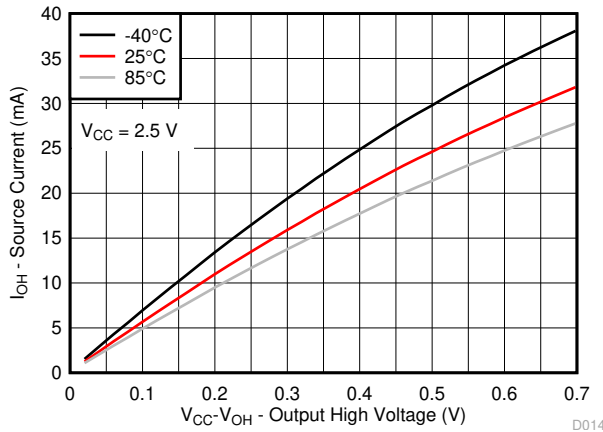


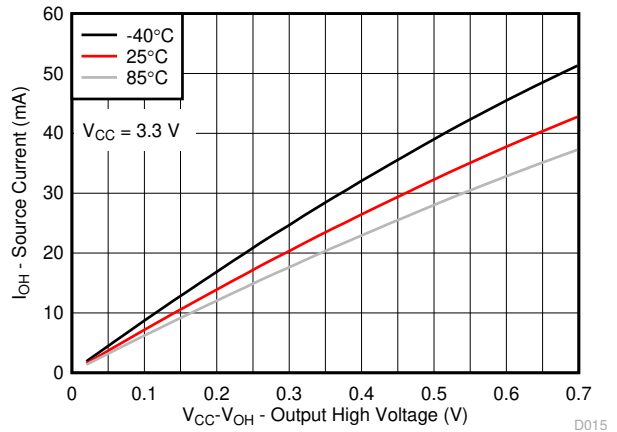
Figure 7-12. I/O Source Current vs Output High Voltage for Different Temperature (T<sub>A</sub>) for V<sub>CC</sub> = 1.8 V

### 7.8 Typical Characteristics (continued)

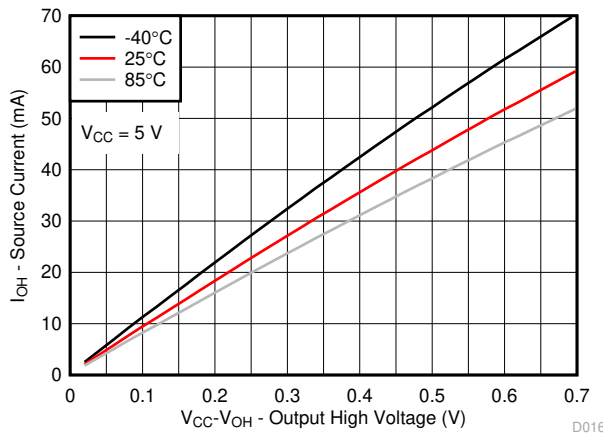
$T_A = 25^\circ\text{C}$  (unless otherwise noted)



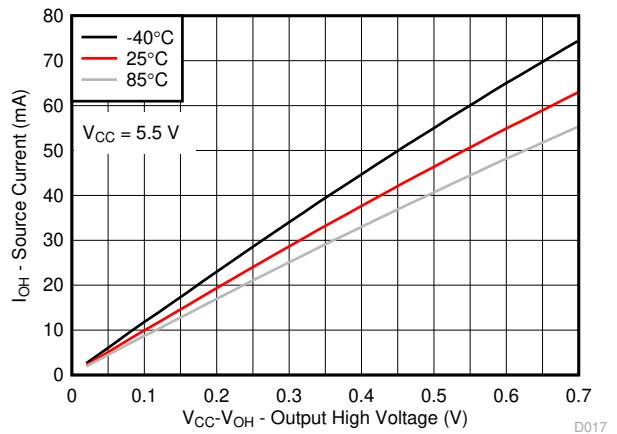
**Figure 7-13. I/O Source Current vs Output High Voltage for Different Temperature ( $T_A$ ) for  $V_{CC} = 2.5\text{ V}$**



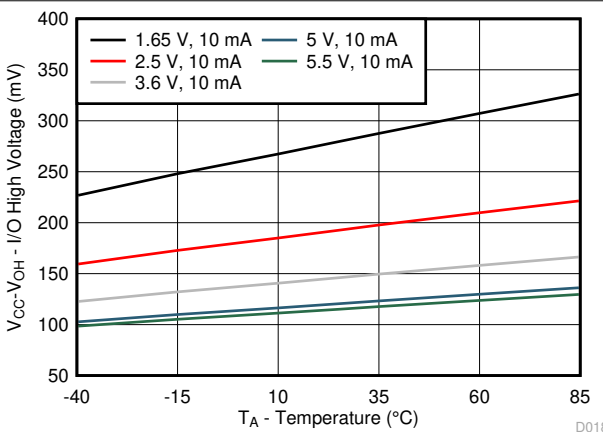
**Figure 7-14. I/O Source Current vs Output High Voltage for Different Temperature ( $T_A$ ) for  $V_{CC} = 3.3\text{ V}$**



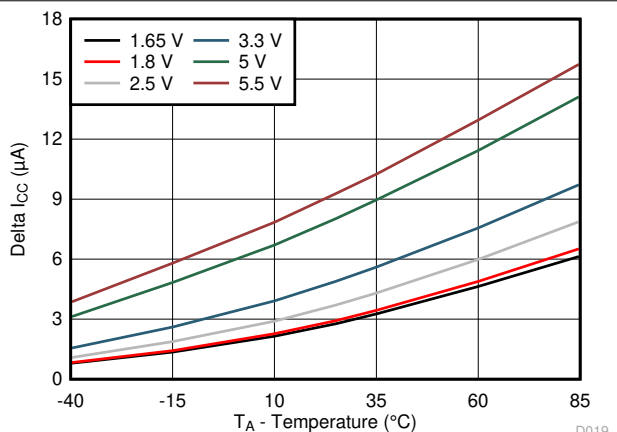
**Figure 7-15. I/O Source Current vs Output High Voltage for Different Temperature ( $T_A$ ) for  $V_{CC} = 5\text{ V}$**



**Figure 7-16. I/O Source Current vs Output High Voltage for Different Temperature ( $T_A$ ) for  $V_{CC} = 5.5\text{ V}$**

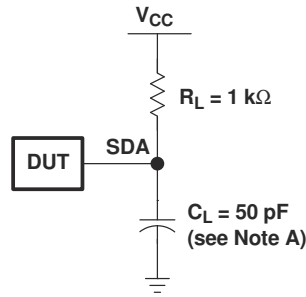


**Figure 7-17.  $V_{CC} - V_{OH}$  Voltage vs Temperature for Different  $V_{CC}$**

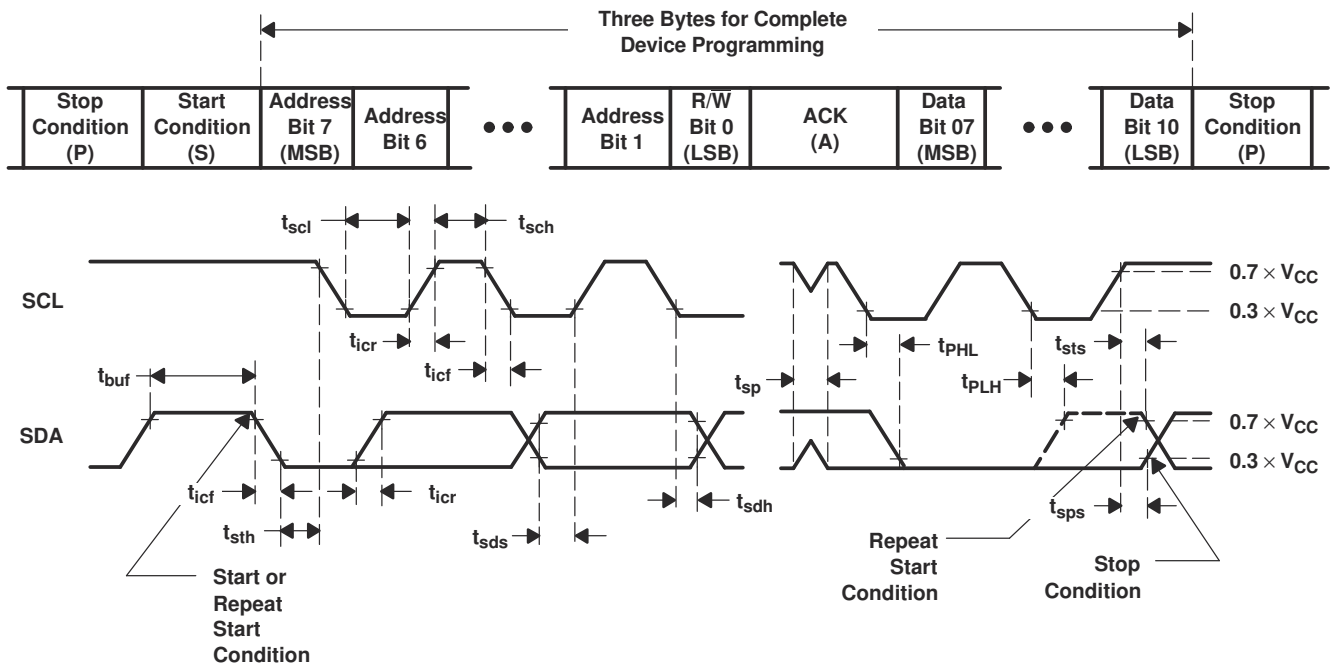


**Figure 7-18.  $\Delta I_{CC}$  vs Temperature for Different  $V_{CC}$  ( $V_I = V_{CC} - 0.6\text{ V}$ )**

## 8 Parameter Measurement Information



SDA LOAD CONFIGURATION



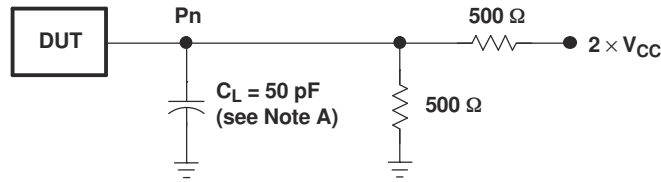
VOLTAGE WAVEFORMS

BYTE	DESCRIPTION
1	I <sup>2</sup> C address
2, 3	P-port data

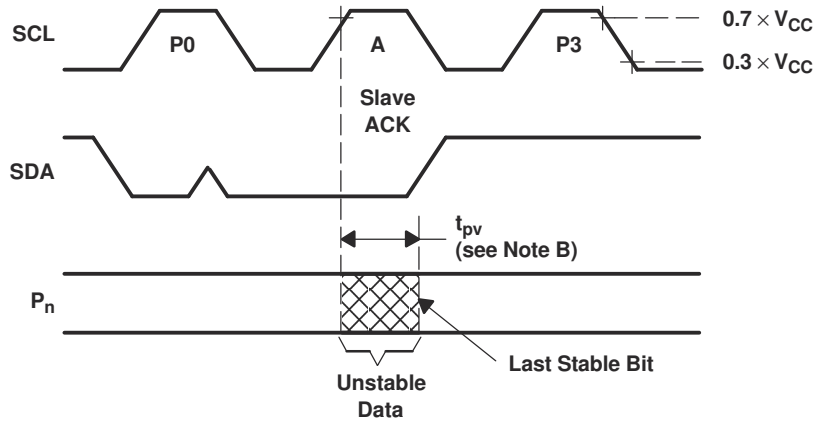
- A.  $C_L$  includes probe and jig capacitance.
- B. All inputs are supplied by generators having the following characteristics:  $PRR \leq 10$  MHz,  $Z_O = 50 \Omega$ ,  $t_r/t_f \leq 30$  ns.
- C. All parameters and waveforms are not applicable to all devices.

Figure 8-1. I<sup>2</sup>C Interface Load Circuit And Voltage Waveforms

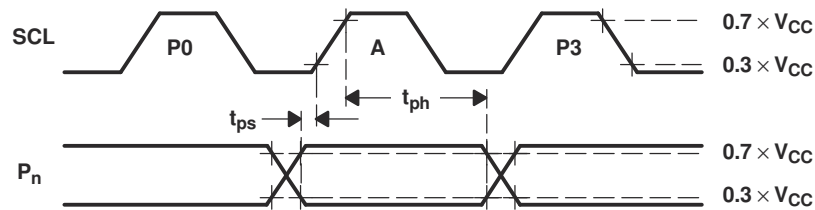




P-PORT LOAD CONFIGURATION



WRITE MODE ( $R/\bar{W} = 0$ )



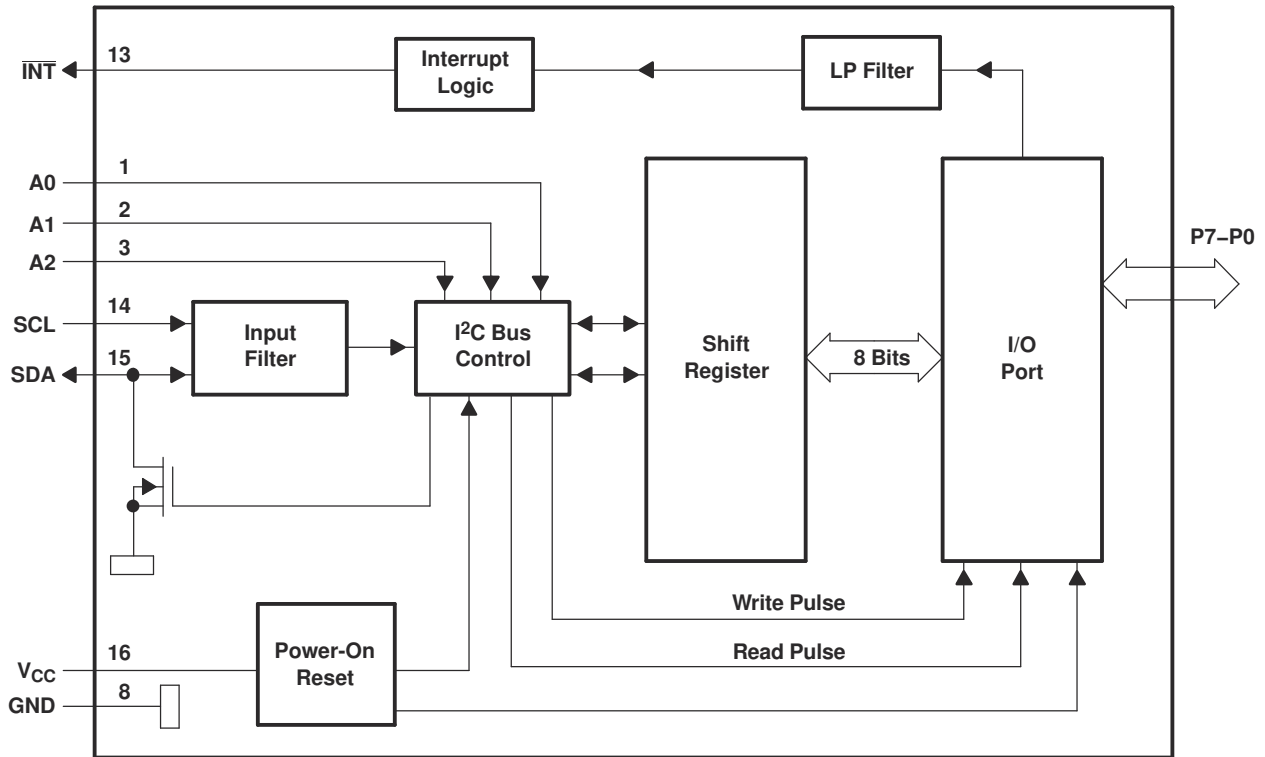
READ MODE ( $R/\bar{W} = 1$ )

- A.  $C_L$  includes probe and jig capacitance.
- B.  $t_{pv}$  is measured from  $0.7 \times V_{CC}$  on SCL to 50% I/O ( $P_n$ ) output.
- C. All inputs are supplied by generators having the following characteristics:  $PRR \leq 10$  MHz,  $Z_O = 50 \Omega$ ,  $t_r/t_f \leq 30$  ns.
- D. The outputs are measured one at a time, with one transition per measurement.
- E. All parameters and waveforms are not applicable to all devices.

**Figure 8-3. P-Port Load Circuit And Voltage Waveforms**

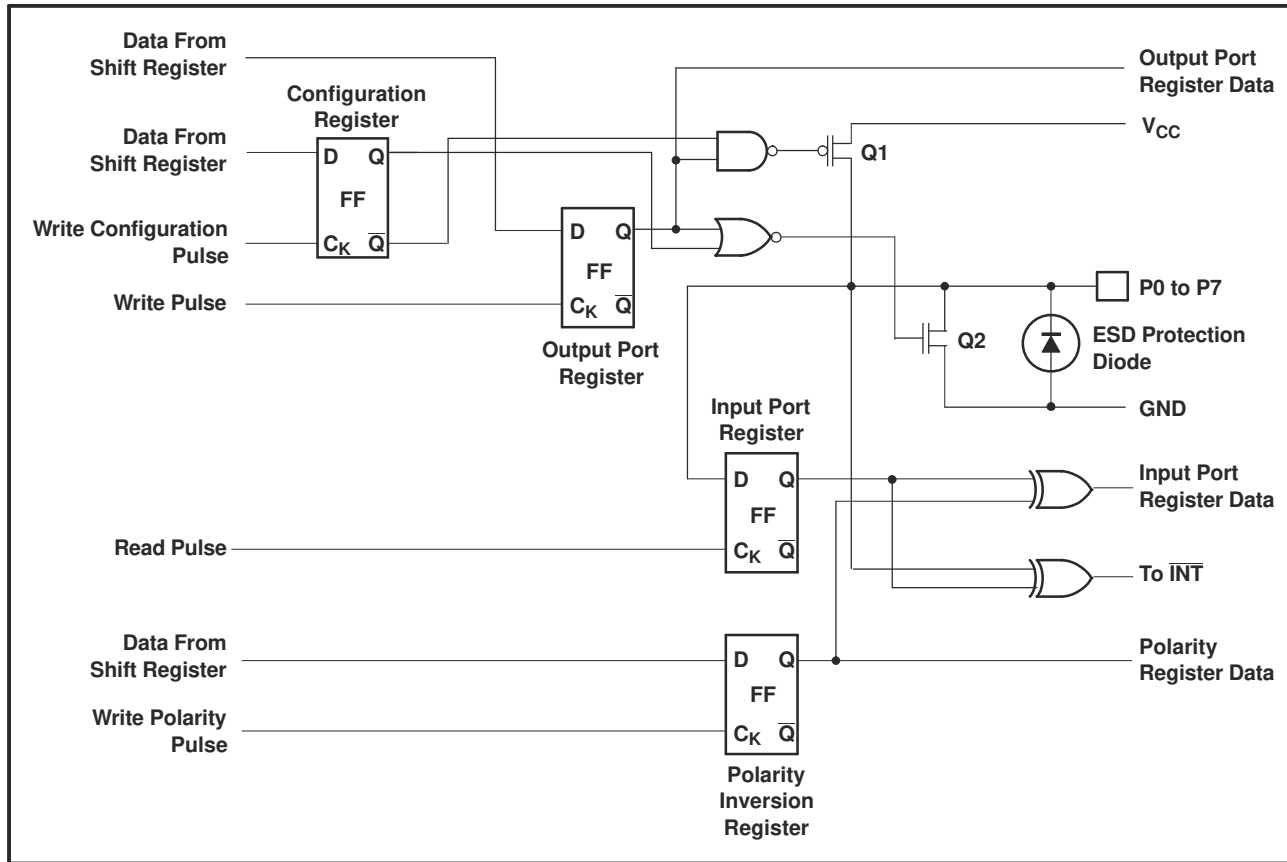
## 9 Detailed Description

### 9.1 Functional Block Diagram



- A. Pin numbers shown are for DB, DBQ, DGV, DW, or PW package.
- B. All I/Os are set to inputs at reset.

**Figure 9-1. Logic Diagram (Positive Logic)**



A. At power-on reset, all registers return to default values.

Figure 9-2. Simplified Schematic Of P0 To P7

## 9.2 Device Functional Modes

### 9.2.1 Power-On Reset

When power (from 0 V) is applied to  $V_{CC}$ , an internal power-on reset holds the PCA9534A in a reset condition until  $V_{CC}$  has reached  $V_{POR}$ . At that point, the reset condition is released and the PCA9534A registers and I<sup>2</sup>C/SMBus state machine initialize to their default states. After that,  $V_{CC}$  must be lowered to below 0.2 V and then back up to the operating voltage for a power-reset cycle.

### 9.2.2 I/O Port

When an I/O is configured as an input, FETs Q1 and Q2 (in Figure 9-2) are off, creating a high-impedance input. The input voltage may be raised above  $V_{CC}$  to a maximum of 5.5 V.

If the I/O is configured as an output, Q1 or Q2 is enabled, depending on the state of the output port register. In this case, there are low-impedance paths between the I/O pin and either  $V_{CC}$  or GND. The external voltage applied to this I/O pin should not exceed the recommended levels for proper operation.

### 9.2.3 Interrupt Output ( $\bar{INT}$ )

An interrupt is generated by any rising or falling edge of the port inputs in the input mode. After time,  $t_{iV}$ , the signal  $\bar{INT}$  is valid. Resetting the interrupt circuit is achieved when data on the port is changed to the original setting, data is read from the port that generated the interrupt. Resetting occurs in the read mode at the acknowledge (ACK) or not acknowledge (NACK) bit after the rising edge of the SCL signal.

Interrupts that occur during the ACK or NACK clock pulse can be lost (or be very short) due to the resetting of the interrupt during this pulse. Each change of the I/Os after resetting is detected and is transmitted as  $\bar{INT}$ . Writing to another device does not affect the interrupt circuit, and a pin configured as an output cannot cause



an interrupt. Changing an I/O from an output to an input may cause a false interrupt to occur, if the state of the pin does not match the contents of the Input Port register. Because each 8-pin port is read independently, the interrupt caused by port 0 is not cleared by a read of port 1 or vice versa.

The  $\overline{\text{INT}}$  output has an open-drain structure and requires pull-up resistor to  $V_{CC}$ .

### 9.2.3.1 Interrupt Errata

#### 9.2.3.1.1 Description

The INT will be improperly de-asserted if the following two conditions occur:

1. The last I<sup>2</sup>C command byte (register pointer) written to the device was 00h.

---

#### Note

This generally means the last operation with the device was a Read of the input register. However, the command byte may have been written with 00h without ever going on to read the input register. After reading from the device, if no other command byte written, it will remain 00h.

2. Any other slave device on the I<sup>2</sup>C bus acknowledges an address byte with the R/W bit set high

#### 9.2.3.1.2 System Impact

Can cause improper interrupt handling as the Master will see the interrupt as being cleared.

#### 9.2.3.1.3 System Workaround

Minor software change: User must change command byte to something besides 00h after a Read operation to the PCA9534A device or before reading from another slave device.

---

#### Note

Software change will be compatible with other versions (competition and TI redesigns) of this device.

## 9.3 Programming

### 9.3.1 I<sup>2</sup>C Interface

The bidirectional I<sup>2</sup>C bus consists of the serial clock (SCL) and serial data (SDA) lines. Both lines must be connected to a positive supply through a pull-up resistor when connected to the output stages of a device. Data transfer may be initiated only when the bus is not busy.

I<sup>2</sup>C communication with this device is initiated by a master sending a start condition, a high-to-low transition on the SDA input/output while the SCL input is high (see [Figure 9-3](#)). After the start condition, the device address byte is sent, MSB first, including the data direction bit (R/W).

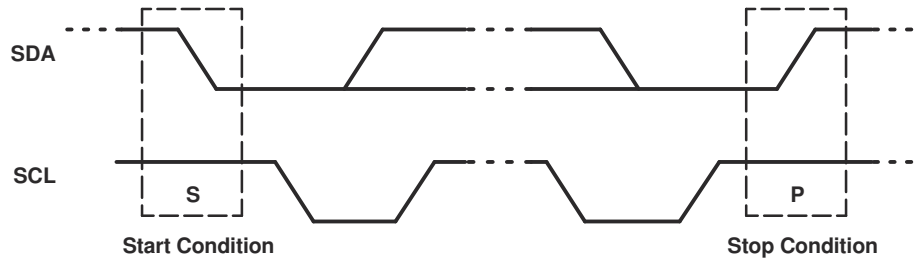
After receiving the valid address byte, this device responds with an acknowledge (ACK), a low on the SDA input/output during the high of the ACK-related clock pulse. The address inputs (A0–A2) of the slave device must not be changed between the start and the stop conditions.

On the I<sup>2</sup>C bus, only one data bit is transferred during each clock pulse. The data on the SDA line must remain stable during the high pulse of the clock period, as changes in the data line at this time are interpreted as control commands (start or stop) (see [Figure 9-4](#)).

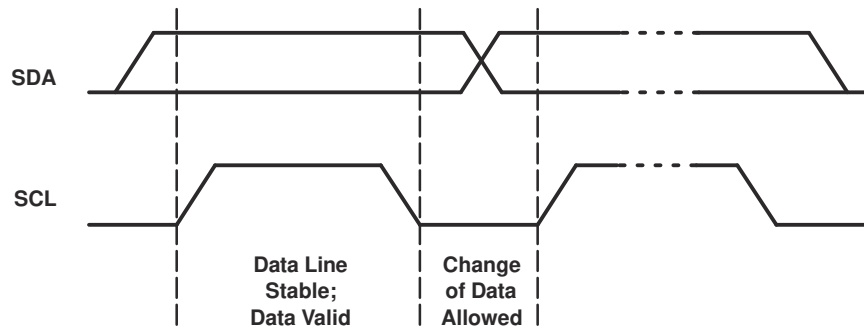
A stop condition, a low-to-high transition on the SDA input/output while the SCL input is high, is sent by the master (see [Figure 9-3](#)).

Any number of data bytes can be transferred from the transmitter to receiver between the start and the stop conditions. Each byte of eight bits is followed by one ACK bit. The transmitter must release the SDA line before the receiver can send an ACK bit. The device that acknowledges must pull down the SDA line during the ACK clock pulse so that the SDA line is stable low during the high pulse of the ACK-related clock period (see [Figure 9-5](#)). When a slave receiver is addressed, it must generate an ACK after each byte is received. Similarly, the master must generate an ACK after each byte that it receives from the slave transmitter. Setup and hold times must be met to ensure proper operation.

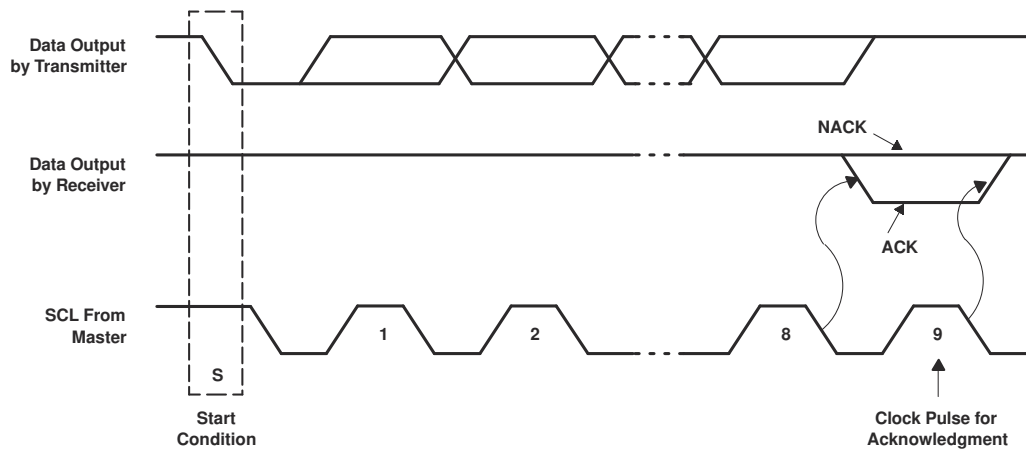
A master receiver will signal an end of data to the slave transmitter by not generating an acknowledge (NACK) after the last byte has been clocked out of the slave. This is done by the master receiver by holding the SDA line high. In this event, the transmitter must release the data line to enable the master to generate a stop condition.



**Figure 9-3. Definition Of Start And Stop Conditions**



**Figure 9-4. Bit Transfer**



**Figure 9-5. Acknowledgment On I<sup>2</sup>C Bus**

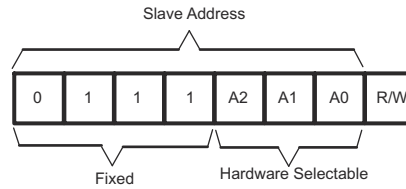
**9.3.2 Register Map**

**Table 9-1. Interface Definition**

BYTE	BIT							
	7 (MSB)	6	5	4	3	2	1	0 (LSB)
I <sup>2</sup> C slave address	L	H	H	H	A2	A1	A0	R/ $\bar{W}$
Px I/O data bus	P7	P6	P5	P4	P3	P2	P1	P0

**9.3.2.1 Device Address**

Figure 9-6 shows the address byte of the PCA9534A.



**Figure 9-6. Pca9534a Address**

**Table 9-2. Address Reference**

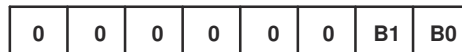
INPUTS			I <sup>2</sup> C BUS SLAVE ADDRESS
A2	A1	A0	
L	L	L	56 (decimal), 38 (hexadecimal)
L	L	H	57 (decimal), 39 (hexadecimal)
L	H	L	58 (decimal), 3A (hexadecimal)
L	H	H	59 (decimal), 3B (hexadecimal)
H	L	L	60 (decimal), 3C (hexadecimal)
H	L	H	61 (decimal), 3D (hexadecimal)
H	H	L	62 (decimal), 3E (hexadecimal)
H	H	H	63 (decimal), 3F (hexadecimal)

The last bit of the slave address defines the operation (read or write) to be performed. When it is high (1), a read is selected, while a low (0) selects a write operation.

### 9.3.2.2 Control Register And Command Byte

Following the successful acknowledgment of the address byte, the bus master sends a command byte which is stored in the control register in the PCA9534A. Two bits of this command byte state the operation (read or write) and the internal register (input, output, polarity inversion or configuration) that will be affected. This register can be written or read through the I<sup>2</sup>C bus. The command byte is sent only during a write transmission.

Once a command byte has been sent, the register that was addressed continues to be accessed by reads until a new command byte has been sent.



**Figure 9-7. Control Register Bits**

**Table 9-3. Command Byte**

CONTROL REGISTER BITS		COMMAND BYTE (HEX)	REGISTER	PROTOCOL	POWER-UP DEFAULT
B1	B0				
0	0	0x00	Input Port	Read byte	xxxx xxxx
0	1	0x01	Output Port	Read/write byte	1111 1111
1	0	0x02	Polarity Inversion	Read/write byte	0000 0000
1	1	0x03	Configuration	Read/write byte	1111 1111

### 9.3.2.3 Register Descriptions

The input port register (register 0) reflects the incoming logic levels of the pins, regardless of whether the pin is defined as an input or an output by the configuration register. It only acts on read operation. Writes to these registers have no effect. The default value, X, is determined by the externally applied logic level.

Before a read operation, a write transmission is sent with the command byte to let the I<sup>2</sup>C device know that the input port register will be accessed next.

**Table 9-4. Register 0 (Input Port Register)**

BIT	I7	I6	I5	I4	I3	I2	I1	I0
DEFAULT	X	X	X	X	X	X	X	X

The output port register (register 1) shows the outgoing logic levels of the pins defined as outputs by the configuration register. Bit values in this register have no effect on pins defined as inputs. In turn, reads from this register reflect the value that is in the flip-flop controlling the output selection, not the actual pin value.

**Table 9-5. Register 1 (Output Port Register)**

BIT	O7	O6	O5	O4	O3	O2	O1	O0
DEFAULT	1	1	1	1	1	1	1	1

The polarity inversion register (register 2) allows polarity inversion of pins defined as inputs by the configuration register. If a bit in this register is set (written with 1), the corresponding port pin polarity is inverted. If a bit in this register is cleared (written with a 0), the corresponding port pin original polarity is retained.

**Table 9-6. Register 2 (Polarity Inversion Register)**

BIT	N7	N6	N5	N4	N3	N2	N1	N0
DEFAULT	0	0	0	0	0	0	0	0

The configuration register (register 3) configures the directions of the I/O pins. If a bit in this register is set to 1, the corresponding port pin is enabled as an input with high-impedance output driver. If a bit in this register is cleared to 0, the corresponding port pin is enabled as an output.

**Table 9-7. Register 3 (Configuration Register)**

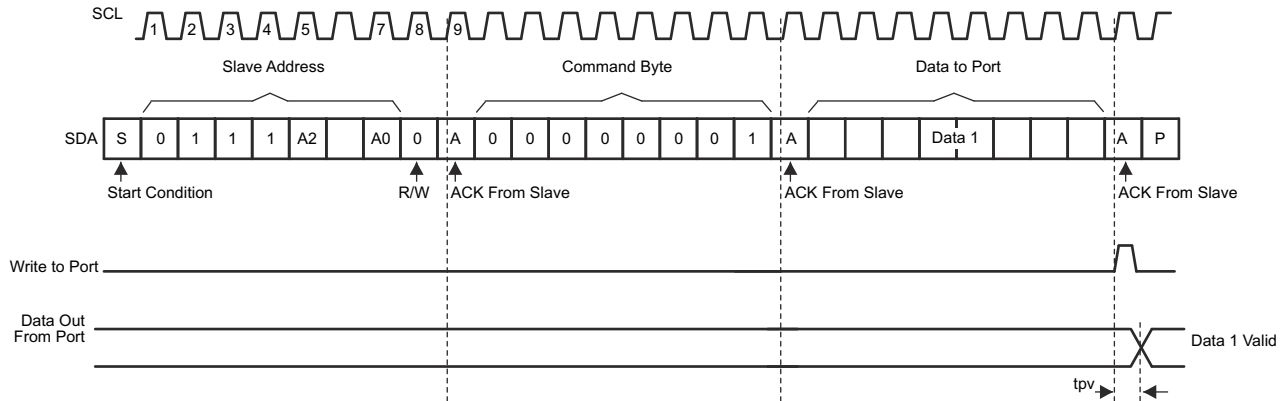
BIT	C7	C6	C5	C4	C3	C2	C1	C0
DEFAULT	1	1	1	1	1	1	1	1

### 9.3.2.4 Bus Transactions

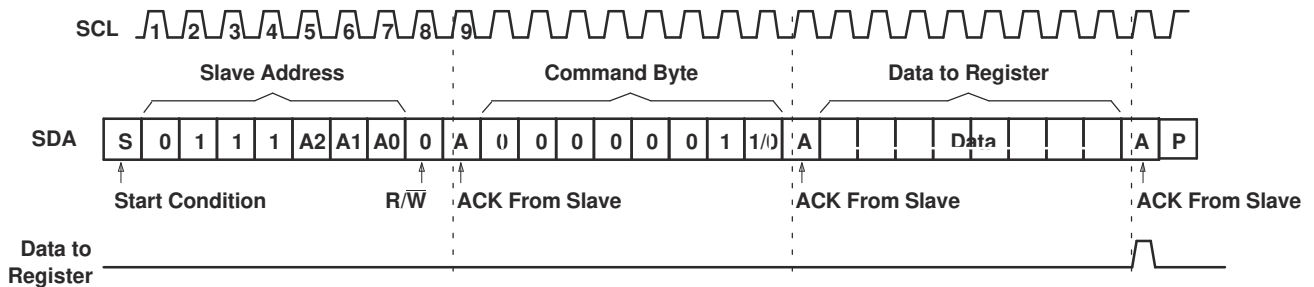
Data is exchanged between the master and PCA9534A through write and read commands.

#### 9.3.2.4.1 Writes

Data is transmitted to the PCA9534A by sending the device address and setting the least-significant bit to a logic 0 (see Figure 9-6 for device address). The command byte is sent after the address and determines which register receives the data that follows the command byte (see Figure 9-8 and Figure 9-9). There is no limitation on the number of data bytes sent in one write transmission.



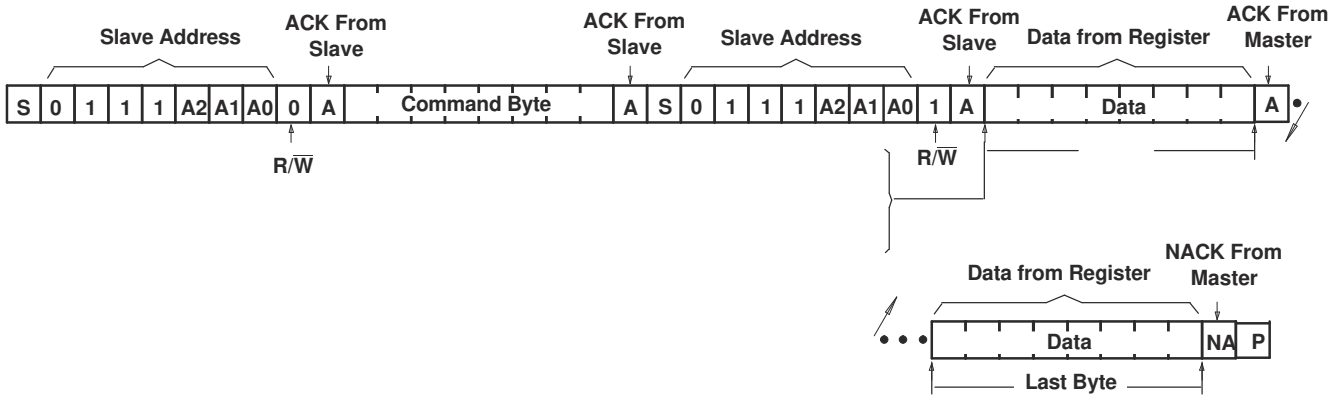
**Figure 9-8. Write To Output Port Register**



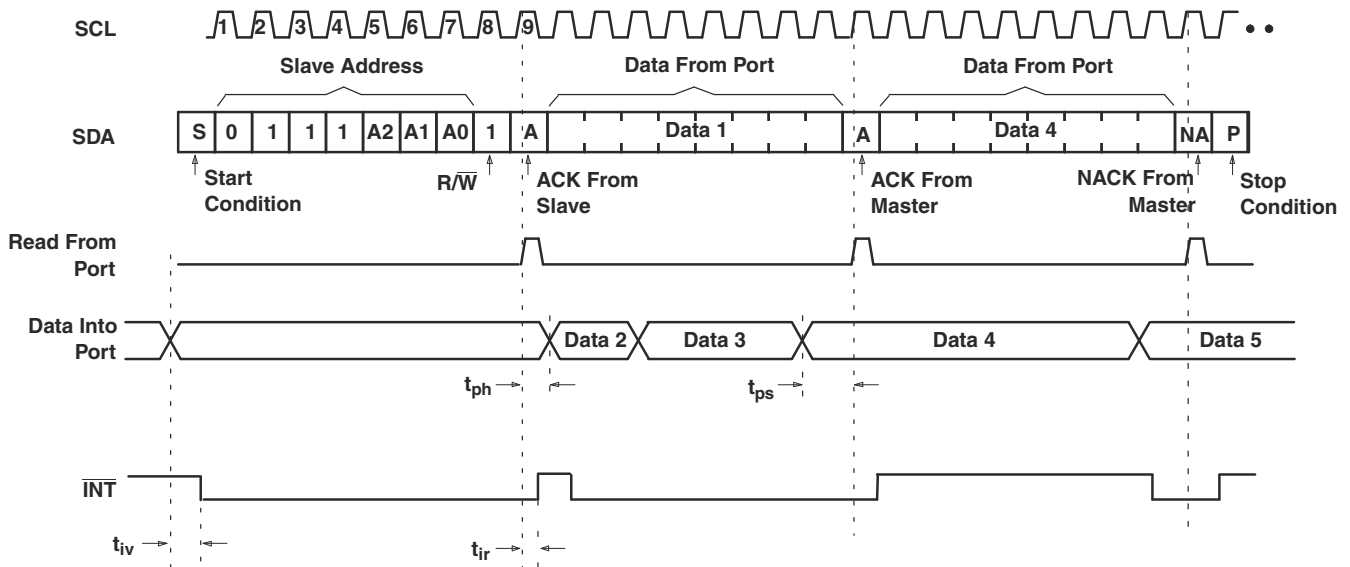
**Figure 9-9. Write To Configuration Or Polarity Inversion Registers**

**9.3.2.4.2 Reads**

The bus master first must send the PCA9534A address with the least-significant bit set to a logic 0 (see Figure 9-6 for device address). The command byte is sent after the address and determines which register is accessed. After a restart, the device address is sent again but, this time, the least-significant bit is set to a logic 1. Data from the register defined by the command byte then is sent by the PCA9534A (see Figure 9-10 and Figure 9-11). After a restart, the value of the register defined by the command byte matches the register being accessed when the restart occurred. Data is clocked into the register on the rising edge of the ACK clock pulse. There is no limitation on the number of data bytes received in one read transmission, but when the final byte is received, the bus master must not acknowledge the data.



**Figure 9-10. Read From Register**



- A. This figure assumes that the command byte has previously been programmed with 00h.
- B. Transfer of data can be stopped at any moment by a stop condition.
- C. This figure eliminates the command byte transfer, a restart and slave address call between the initial slave address call and the actual data transfer from the P Port. See Figure 9-10 for these details.

**Figure 9-11. Read Input Port Register**

## 10 Application Information Disclaimer

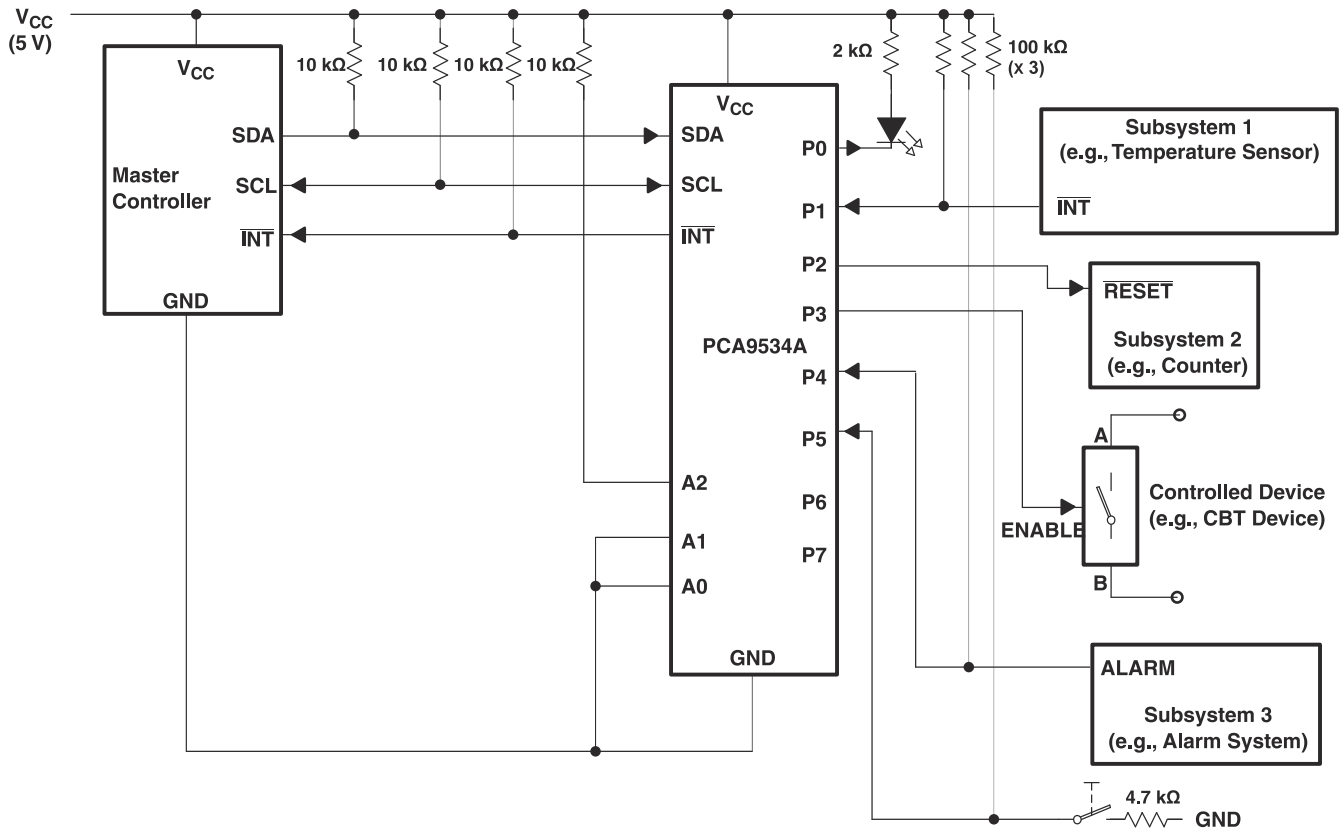
### Note

Information in the following applications sections is not part of the TI component specification, and TI does not warrant its accuracy or completeness. TI's customers are responsible for determining suitability of components for their purposes, as well as validating and testing their design implementation to confirm system functionality.

## 10.1 Application Information

### 10.1.1 Typical Application

Figure 10-1 shows an application in which the PCA9534A can be used.



- A. Device address is configured as 0111100 for this example.
- B. P0, P2, and P3 are configured as outputs.
- C. P1, P4, and P5 are configured as inputs.
- D. P6 and P7 are not used and must be configured as outputs.

**Figure 10-1. Typical Application**

### 10.1.1.1 Design Requirements

#### 10.1.1.1.1 Minimizing $I_{CC}$ When The I/O Controls Leds

When the I/Os are used to control LEDs, they normally are connected to  $V_{CC}$  through a resistor as shown in Figure 10-1. Because the LED acts as a diode, when the LED is off, the I/O  $V_{IN}$  is about 1.2 V less than  $V_{CC}$ . The supply current,  $I_{CC}$ , increases as  $V_{IN}$  becomes lower than  $V_{CC}$  and is specified as  $\Delta I_{CC}$  in *Electrical Characteristics*.

For battery-powered applications, it is essential that the voltage of the I/O pins is greater than or equal to  $V_{CC}$  when the LED is off to minimize current consumption. Figure 10-2 shows a high-value resistor in parallel with the LED. Figure 10-3 shows  $V_{CC}$  less than the LED supply voltage by at least 1.2 V. Both of these methods maintain the I/O  $V_{IN}$  at or above  $V_{CC}$  and prevents additional supply-current consumption when the LED is off.

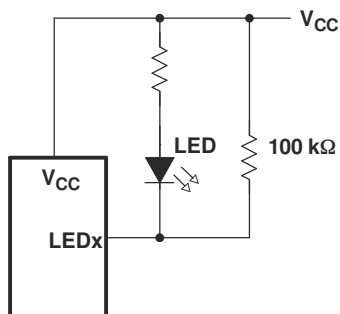


Figure 10-2. High-Value Resistor In Parallel With The Led

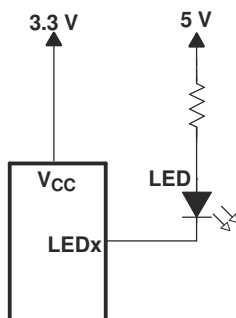


Figure 10-3. Device Supplied By A Lower Voltage

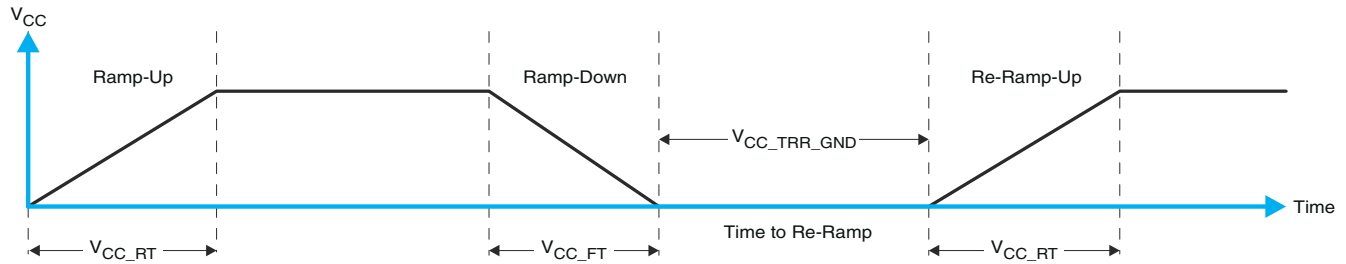


## 11 Power Supply Recommendations

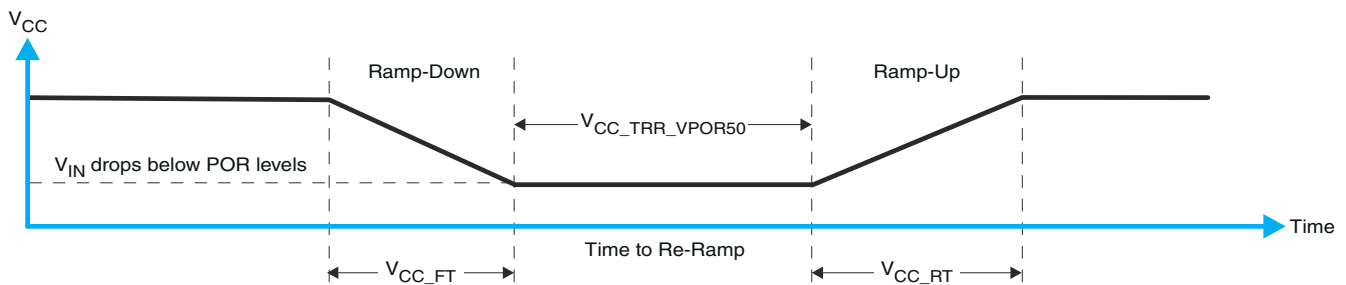
### 11.1 Power-On Reset Requirements

In the event of a glitch or data corruption, PCA9534A can be reset to its default conditions by using the power-on reset feature. Power-on reset requires that the device go through a power cycle to be completely reset. This reset also happens when the device is powered on for the first time in an application.

The two types of power-on reset are shown in [Figure 11-1](#) and [Figure 11-2](#).



**Figure 11-1.  $V_{CC}$  Is Lowered Below 0.2 V Or 0 V And Then Ramped Up To  $V_{CC}$**



**Figure 11-2.  $V_{CC}$  Is Lowered Below The Por Threshold, Then Ramped Back Up To  $V_{CC}$**

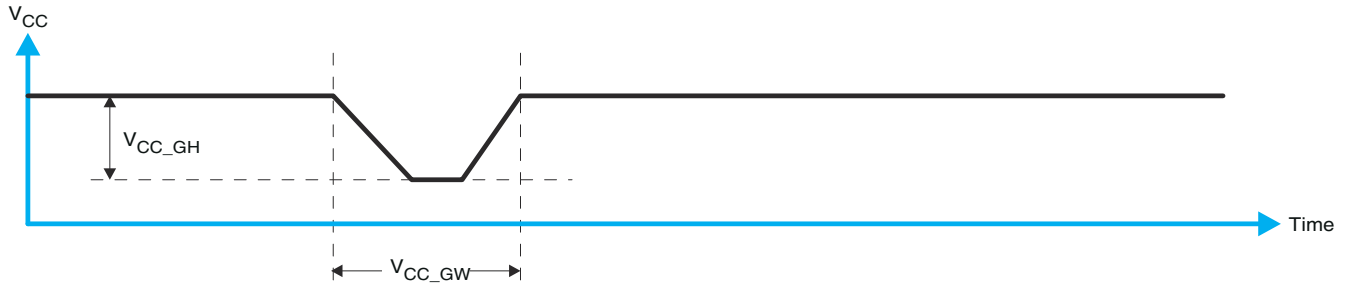
[Table 11-1](#) specifies the performance of the power-on reset feature for PCA9534A for both types of power-on reset.

**Table 11-1. Recommended Supply Sequencing And Ramp Rates <sup>(1)</sup>**

PARAMETER		MIN	TYP	MAX	UNIT
$V_{CC\_FT}$	Fall rate	See <a href="#">Figure 11-1</a>	1	100	ms
$V_{CC\_RT}$	Rise rate	See <a href="#">Figure 11-1</a>	0.01	100	ms
$V_{CC\_TRR\_GND}$	Time to re-ramp (when $V_{CC}$ drops to GND)	See <a href="#">Figure 11-1</a>	0.001		ms
$V_{CC\_TRR\_POR50}$	Time to re-ramp (when $V_{CC}$ drops to $V_{POR\_MIN} - 50$ mV)	See <a href="#">Figure 11-2</a>	0.001		ms
$V_{CC\_GH}$	Level that $V_{CCP}$ can glitch down to, but not cause a functional disruption when $V_{CCX\_GW} = 1$ $\mu$ s	See <a href="#">Figure 11-3</a>		1.2	V
$V_{CC\_GW}$	Glitch width that will not cause a functional disruption when $V_{CCX\_GH} = 0.5 \times V_{CCX}$	See <a href="#">Figure 11-3</a>			$\mu$ s
$V_{PORF}$	Voltage trip point of POR on falling $V_{CC}$		0.767	1.144	V
$V_{PORR}$	Voltage trip point of POR on rising $V_{CC}$		1.033	1.428	V

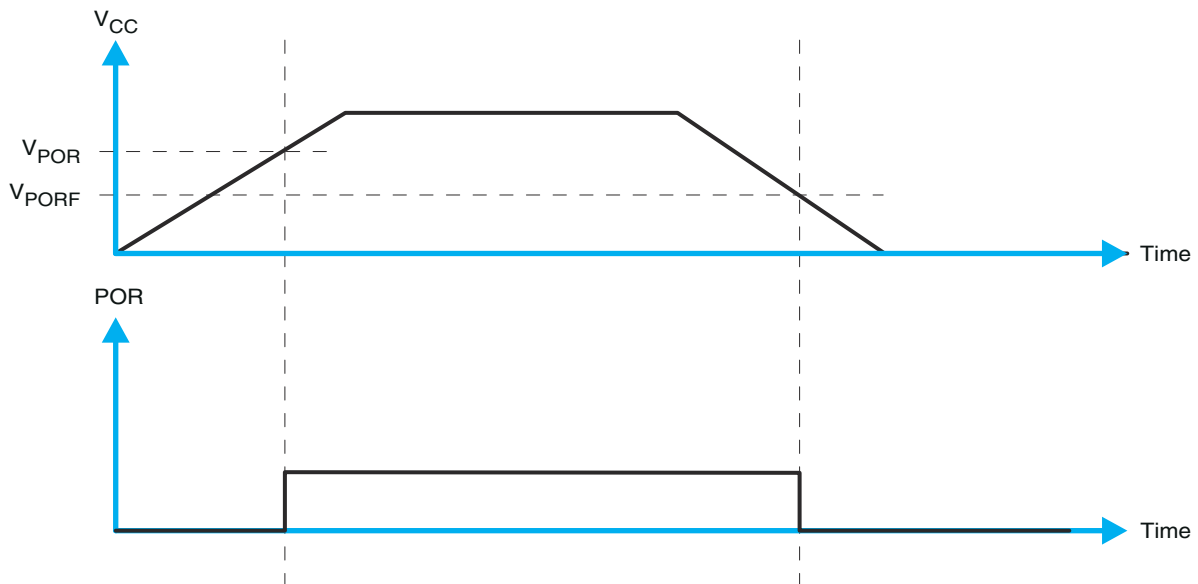
(1)  $T_A = -40^\circ\text{C}$  to  $85^\circ\text{C}$  (unless otherwise noted)

Glitches in the power supply can also affect the power-on reset performance of this device. The glitch width ( $V_{CC\_GW}$ ) and height ( $V_{CC\_GH}$ ) are dependent on each other. The bypass capacitance, source impedance, and the device impedance are factors that affect power-on reset performance. [Figure 11-3](#) and [Table 11-1](#) provide more information on how to measure these specifications.



**Figure 11-3. Glitch Width And Glitch Height**

$V_{POR}$  is critical to the power-on reset.  $V_{POR}$  is the voltage level at which the reset condition is released and all the registers and the I<sup>2</sup>C/SMBus state machine are initialized to their default states. The value of  $V_{POR}$  differs based on the  $V_{CC}$  being lowered to or from 0. Figure 11-4 and Table 11-1 provide more details on this specification.



**Figure 11-4.  $V_{POR}$**

## 12 Device and Documentation Support

### 12.1 Trademarks

All trademarks are the property of their respective owners.

### 12.2 Electrostatic Discharge Caution



This integrated circuit can be damaged by ESD. Texas Instruments recommends that all integrated circuits be handled with appropriate precautions. Failure to observe proper handling and installation procedures can cause damage.

ESD damage can range from subtle performance degradation to complete device failure. Precision integrated circuits may be more susceptible to damage because very small parametric changes could cause the device not to meet its published specifications.

### 12.3 Glossary

[TI Glossary](#) This glossary lists and explains terms, acronyms, and definitions.

## 13 Mechanical, Packaging, and Orderable Information

The following pages include mechanical, packaging, and orderable information. This information is the most current data available for the designated devices. This data is subject to change without notice and revision of this document. For browser-based versions of this data sheet, refer to the left-hand navigation.

**PACKAGING INFORMATION**

Orderable Device	Status (1)	Package Type	Package Drawing	Pins	Package Qty	Eco Plan (2)	Lead finish/ Ball material (6)	MSL Peak Temp (3)	Op Temp (°C)	Device Marking (4/5)	Samples
PCA9534ADB	ACTIVE	SSOP	DB	16	80	RoHS & Green	NIPDAU	Level-1-260C-UNLIM	-40 to 85	PD534A	<a href="#">Samples</a>
PCA9534ADBR	ACTIVE	SSOP	DB	16	2000	RoHS & Green	NIPDAU	Level-1-260C-UNLIM	-40 to 85	PD534A	<a href="#">Samples</a>
PCA9534ADGVR	ACTIVE	TVSOP	DGV	16	2000	RoHS & Green	NIPDAU	Level-1-260C-UNLIM	-40 to 85	PD534A	<a href="#">Samples</a>
PCA9534ADW	OBSOLETE	SOIC	DW	16		TBD	Call TI	Call TI	-40 to 85	PCA9534A	
PCA9534ADWR	OBSOLETE	SOIC	DW	16		TBD	Call TI	Call TI	-40 to 85	PCA9534A	
PCA9534APWR	ACTIVE	TSSOP	PW	16	2000	RoHS & Green	NIPDAU	Level-1-260C-UNLIM	-40 to 85	PD534A	<a href="#">Samples</a>
PCA9534ARGTR	ACTIVE	VQFN	RGT	16	3000	RoHS & Green	NIPDAU	Level-2-260C-1 YEAR	-40 to 85	ZVJ	<a href="#">Samples</a>
PCA9534ARGTRG4	ACTIVE	VQFN	RGT	16	3000	RoHS & Green	NIPDAU	Level-2-260C-1 YEAR	-40 to 85	ZVJ	<a href="#">Samples</a>
PCA9534ARGVR	ACTIVE	VQFN	RGV	16	2500	RoHS & Green	NIPDAU	Level-2-260C-1 YEAR	-40 to 85	PD534A	<a href="#">Samples</a>

(1) The marketing status values are defined as follows:

**ACTIVE:** Product device recommended for new designs.

**LIFEBUY:** TI has announced that the device will be discontinued, and a lifetime-buy period is in effect.

**NRND:** Not recommended for new designs. Device is in production to support existing customers, but TI does not recommend using this part in a new design.

**PREVIEW:** Device has been announced but is not in production. Samples may or may not be available.

**OBSOLETE:** TI has discontinued the production of the device.

(2) **RoHS:** TI defines "RoHS" to mean semiconductor products that are compliant with the current EU RoHS requirements for all 10 RoHS substances, including the requirement that RoHS substance do not exceed 0.1% by weight in homogeneous materials. Where designed to be soldered at high temperatures, "RoHS" products are suitable for use in specified lead-free processes. TI may reference these types of products as "Pb-Free".

**RoHS Exempt:** TI defines "RoHS Exempt" to mean products that contain lead but are compliant with EU RoHS pursuant to a specific EU RoHS exemption.

**Green:** TI defines "Green" to mean the content of Chlorine (Cl) and Bromine (Br) based flame retardants meet JS709B low halogen requirements of <=1000ppm threshold. Antimony trioxide based flame retardants must also meet the <=1000ppm threshold requirement.

(3) MSL, Peak Temp. - The Moisture Sensitivity Level rating according to the JEDEC industry standard classifications, and peak solder temperature.

(4) There may be additional marking, which relates to the logo, the lot trace code information, or the environmental category on the device.

(5) Multiple Device Markings will be inside parentheses. Only one Device Marking contained in parentheses and separated by a "~" will appear on a device. If a line is indented then it is a continuation of the previous line and the two combined represent the entire Device Marking for that device.

<sup>(6)</sup> Lead finish/Ball material - Orderable Devices may have multiple material finish options. Finish options are separated by a vertical ruled line. Lead finish/Ball material values may wrap to two lines if the finish value exceeds the maximum column width.

**Important Information and Disclaimer:**The information provided on this page represents TI's knowledge and belief as of the date that it is provided. TI bases its knowledge and belief on information provided by third parties, and makes no representation or warranty as to the accuracy of such information. Efforts are underway to better integrate information from third parties. TI has taken and continues to take reasonable steps to provide representative and accurate information but may not have conducted destructive testing or chemical analysis on incoming materials and chemicals. TI and TI suppliers consider certain information to be proprietary, and thus CAS numbers and other limited information may not be available for release.

In no event shall TI's liability arising out of such information exceed the total purchase price of the TI part(s) at issue in this document sold by TI to Customer on an annual basis.

**TAPE AND REEL INFORMATION**

**QUADRANT ASSIGNMENTS FOR PIN 1 ORIENTATION IN TAPE**


\*All dimensions are nominal

Device	Package Type	Package Drawing	Pins	SPQ	Reel Diameter (mm)	Reel Width W1 (mm)	A0 (mm)	B0 (mm)	K0 (mm)	P1 (mm)	W (mm)	Pin1 Quadrant
PCA9534ADBR	SSOP	DB	16	2000	330.0	16.4	8.35	6.6	2.4	12.0	16.0	Q1
PCA9534ADGVR	TVSOP	DGV	16	2000	330.0	12.4	6.8	4.0	1.6	8.0	12.0	Q1
PCA9534APWR	TSSOP	PW	16	2000	330.0	12.4	6.9	5.6	1.6	8.0	12.0	Q1
PCA9534APWR	TSSOP	PW	16	2000	330.0	12.4	6.9	5.6	1.6	8.0	12.0	Q1
PCA9534ARGTR	VQFN	RGT	16	3000	330.0	12.4	3.3	3.3	1.1	8.0	12.0	Q2
PCA9534ARGVR	VQFN	RGV	16	2500	330.0	12.4	4.25	4.25	1.15	8.0	12.0	Q2

**TAPE AND REEL BOX DIMENSIONS**


\*All dimensions are nominal

Device	Package Type	Package Drawing	Pins	SPQ	Length (mm)	Width (mm)	Height (mm)
PCA9534ADBR	SSOP	DB	16	2000	356.0	356.0	35.0
PCA9534ADGVR	TVSOP	DGV	16	2000	356.0	356.0	35.0
PCA9534APWR	TSSOP	PW	16	2000	356.0	356.0	35.0
PCA9534APWR	TSSOP	PW	16	2000	356.0	356.0	35.0
PCA9534ARGTR	VQFN	RGT	16	3000	367.0	367.0	35.0
PCA9534ARGVR	VQFN	RGV	16	2500	356.0	356.0	35.0

**TUBE**


\*All dimensions are nominal

Device	Package Name	Package Type	Pins	SPQ	L (mm)	W (mm)	T (μm)	B (mm)
PCA9534ADB	DB	SSOP	16	80	530	10.5	4000	4.1



## GENERIC PACKAGE VIEW

**DW 16**

**SOIC - 2.65 mm max height**

7.5 x 10.3, 1.27 mm pitch

SMALL OUTLINE INTEGRATED CIRCUIT

This image is a representation of the package family, actual package may vary.  
Refer to the product data sheet for package details.



4224780/A

**RGT 16**

**GENERIC PACKAGE VIEW**

**VQFN - 1 mm max height**

PLASTIC QUAD FLATPACK - NO LEAD



Images above are just a representation of the package family, actual package may vary.  
Refer to the product data sheet for package details.

4203495/1



SIDE WALL METAL THICKNESS DIM A	
OPTION 1	OPTION 2
0.1	0.2



4222419/D 04/2022

NOTES:

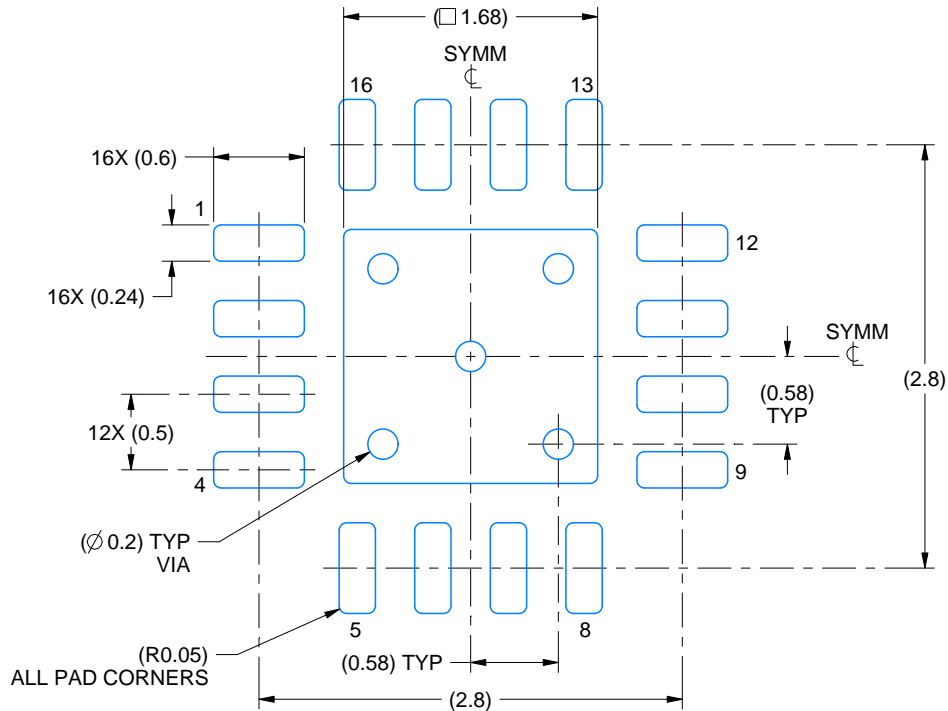
1. All linear dimensions are in millimeters. Any dimensions in parenthesis are for reference only. Dimensioning and tolerancing per ASME Y14.5M.
2. This drawing is subject to change without notice.
3. The package thermal pad must be soldered to the printed circuit board for thermal and mechanical performance.

# EXAMPLE BOARD LAYOUT

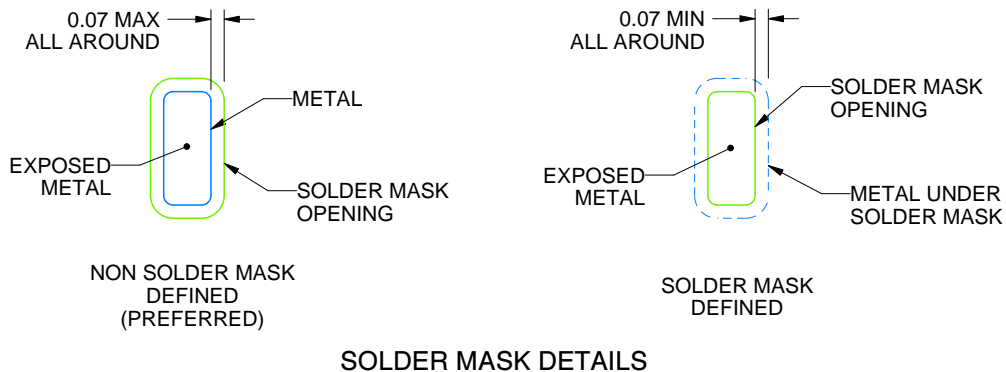
RGT0016C

VQFN - 1 mm max height

PLASTIC QUAD FLATPACK - NO LEAD



LAND PATTERN EXAMPLE  
EXPOSED METAL SHOWN  
SCALE:20X



SOLDER MASK DETAILS

4222419/D 04/2022

NOTES: (continued)

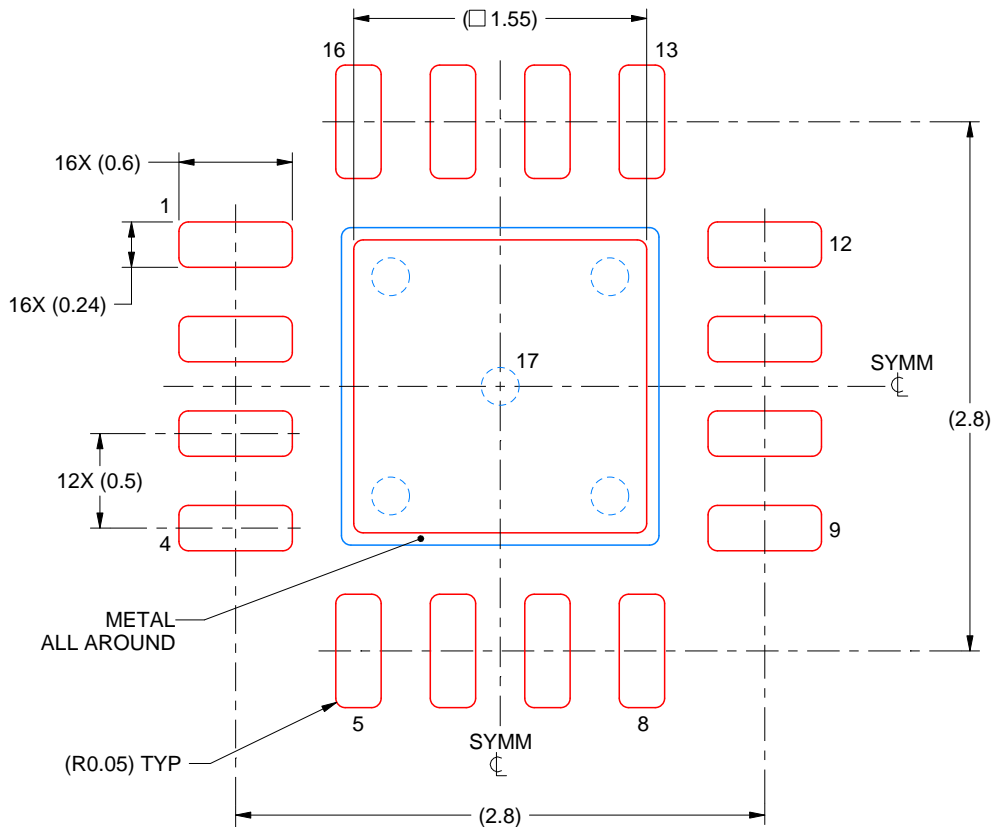
4. This package is designed to be soldered to a thermal pad on the board. For more information, see Texas Instruments literature number SLUA271 ([www.ti.com/lit/sluea271](http://www.ti.com/lit/sluea271)).
5. Vias are optional depending on application, refer to device data sheet. If any vias are implemented, refer to their locations shown on this view. It is recommended that vias under paste be filled, plugged or tented.

# EXAMPLE STENCIL DESIGN

RGT0016C

VQFN - 1 mm max height

PLASTIC QUAD FLATPACK - NO LEAD



**SOLDER PASTE EXAMPLE**  
BASED ON 0.125 mm THICK STENCIL

EXPOSED PAD 17:  
85% PRINTED SOLDER COVERAGE BY AREA UNDER PACKAGE  
SCALE:25X

4222419/D 04/2022

NOTES: (continued)

6. Laser cutting apertures with trapezoidal walls and rounded corners may offer better paste release. IPC-7525 may have alternate design recommendations.

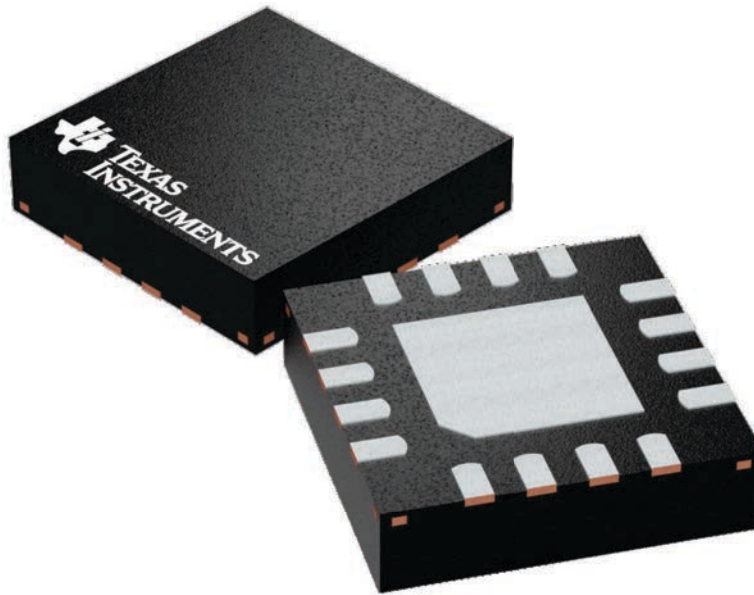
## GENERIC PACKAGE VIEW

**RGV 16**

**VQFN - 1 mm max height**

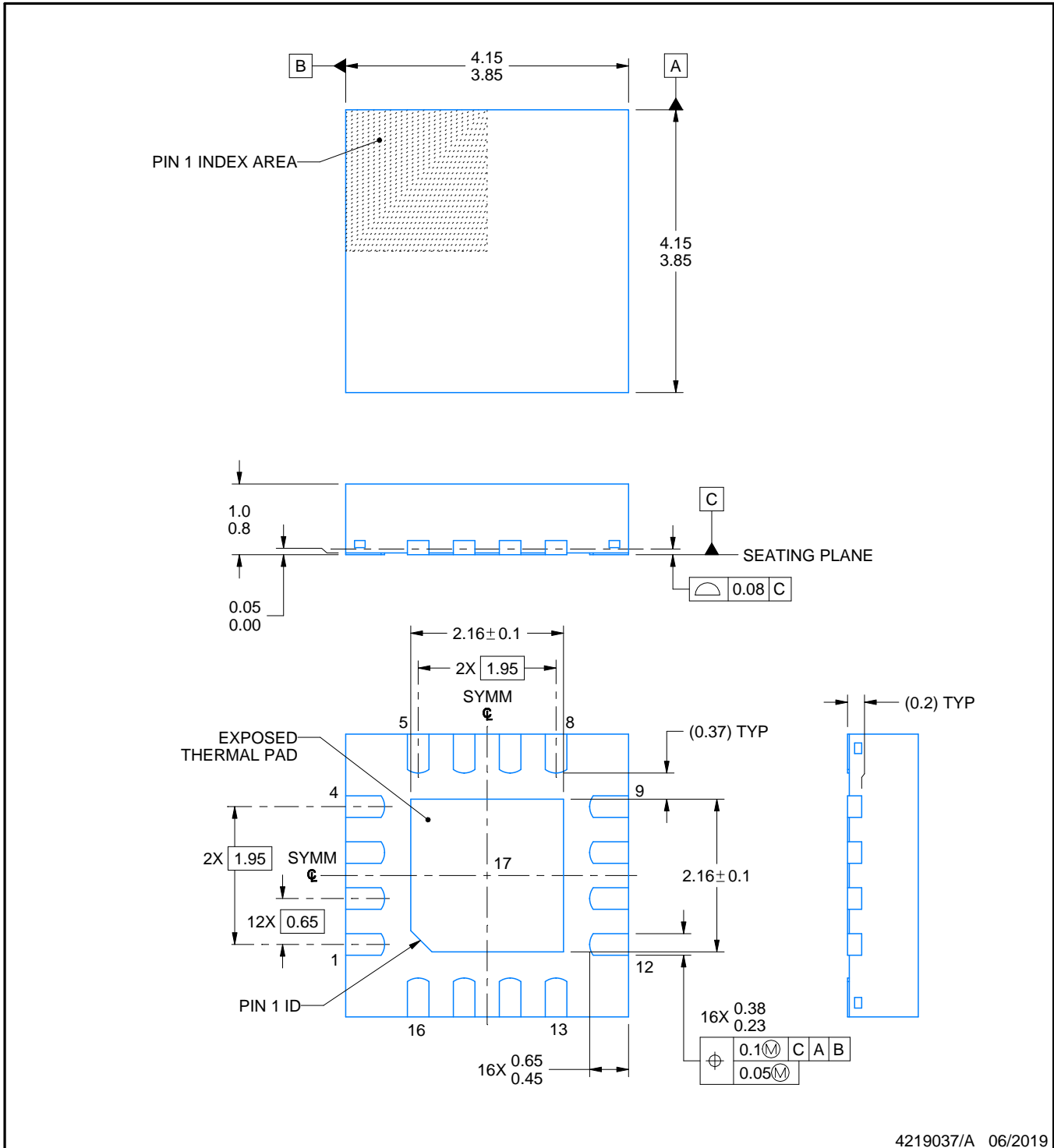
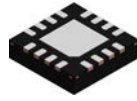
4 x 4, 0.65 mm pitch

PLASTIC QUAD FLATPACK - NO LEAD



Images above are just a representation of the package family, actual package may vary.  
Refer to the product data sheet for package details.

4224748/A



NOTES:

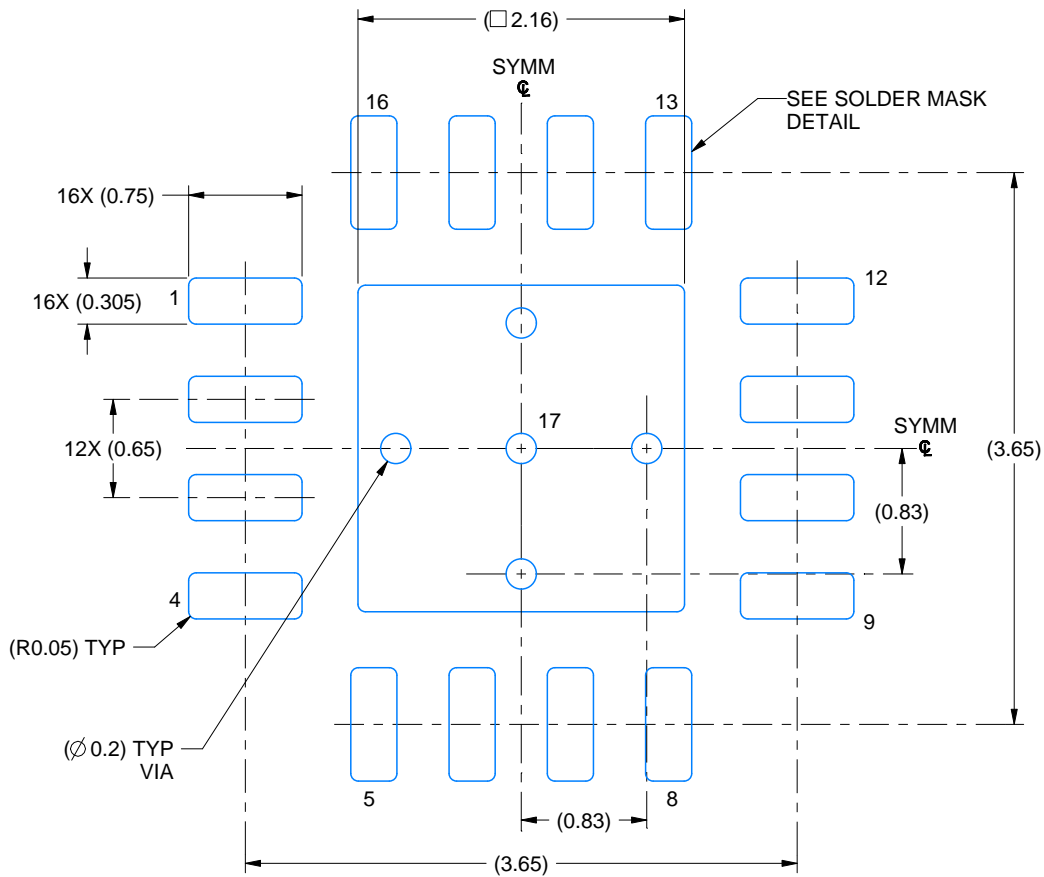
1. All linear dimensions are in millimeters. Any dimensions in parenthesis are for reference only. Dimensioning and tolerancing per ASME Y14.5M.
2. This drawing is subject to change without notice.
3. The package thermal pad must be soldered to the printed circuit board for thermal and mechanical performance.

# EXAMPLE BOARD LAYOUT

RGV0016A

VQFN - 1 mm max height

PLASTIC QUAD FLATPACK - NO LEAD



LAND PATTERN EXAMPLE  
EXPOSED METAL SHOWN  
SCALE: 20X



4219037/A 06/2019

NOTES: (continued)

- This package is designed to be soldered to a thermal pad on the board. For more information, see Texas Instruments literature number SLUA271 ([www.ti.com/lit/sluea271](http://www.ti.com/lit/sluea271)).
- Vias are optional depending on application, refer to device data sheet. If any vias are implemented, refer to their locations shown on this view. It is recommended that vias under paste be filled, plugged or tented.

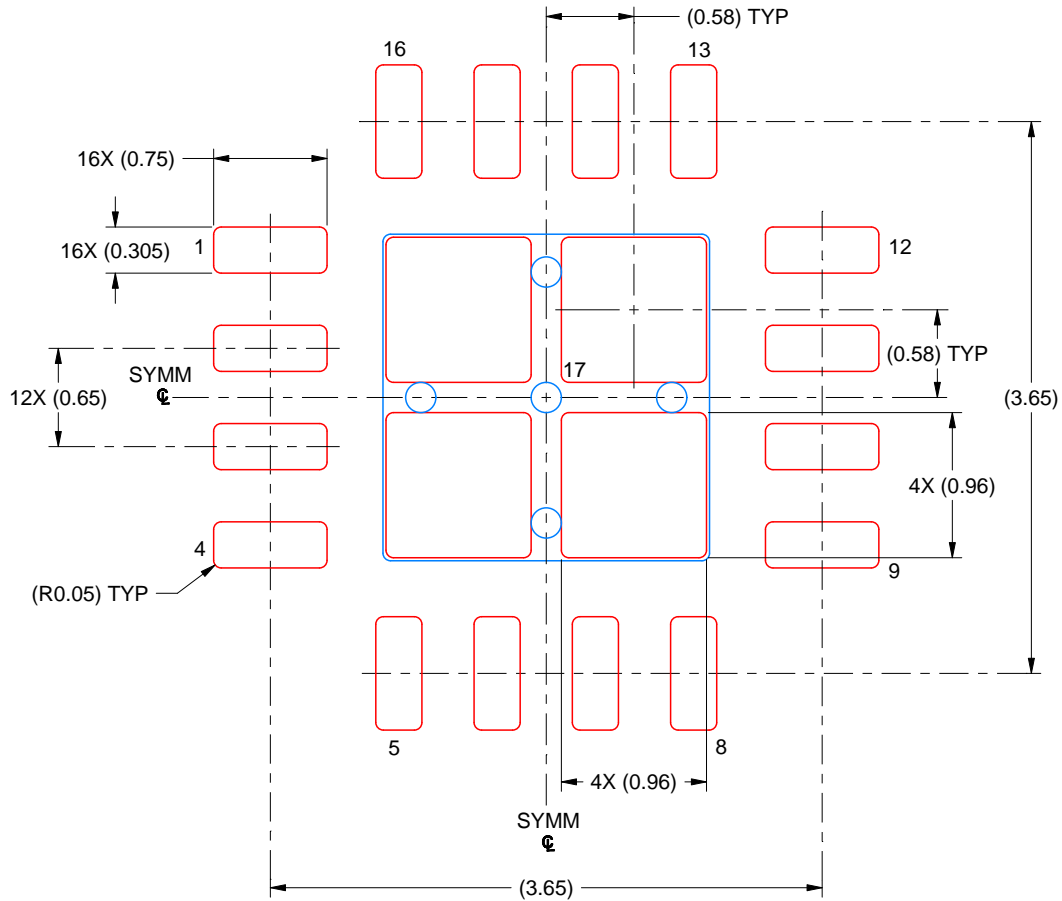


# EXAMPLE STENCIL DESIGN

RGV0016A

VQFN - 1 mm max height

PLASTIC QUAD FLATPACK - NO LEAD



SOLDER PASTE EXAMPLE  
BASED ON 0.125 MM THICK STENCIL  
SCALE: 20X

EXPOSED PAD 17  
79% PRINTED SOLDER COVERAGE BY AREA UNDER PACKAGE

4219037/A 06/2019

NOTES: (continued)

6. Laser cutting apertures with trapezoidal walls and rounded corners may offer better paste release. IPC-7525 may have alternate design recommendations.



4220204/A 02/2017

NOTES:

1. All linear dimensions are in millimeters. Any dimensions in parenthesis are for reference only. Dimensioning and tolerancing per ASME Y14.5M.
2. This drawing is subject to change without notice.
3. This dimension does not include mold flash, protrusions, or gate burrs. Mold flash, protrusions, or gate burrs shall not exceed 0.15 mm per side.
4. This dimension does not include interlead flash. Interlead flash shall not exceed 0.25 mm per side.
5. Reference JEDEC registration MO-153.

# EXAMPLE BOARD LAYOUT

PW0016A

TSSOP - 1.2 mm max height

SMALL OUTLINE PACKAGE



LAND PATTERN EXAMPLE  
EXPOSED METAL SHOWN  
SCALE: 10X



SOLDER MASK DETAILS

4220204/A 02/2017

NOTES: (continued)

- 6. Publication IPC-7351 may have alternate designs.
- 7. Solder mask tolerances between and around signal pads can vary based on board fabrication site.

# EXAMPLE STENCIL DESIGN

PW0016A

TSSOP - 1.2 mm max height

SMALL OUTLINE PACKAGE



SOLDER PASTE EXAMPLE  
BASED ON 0.125 mm THICK STENCIL  
SCALE: 10X

4220204/A 02/2017

NOTES: (continued)

8. Laser cutting apertures with trapezoidal walls and rounded corners may offer better paste release. IPC-7525 may have alternate design recommendations.
9. Board assembly site may have different recommendations for stencil design.

# DB0016A



# PACKAGE OUTLINE

## SSOP - 2 mm max height

SMALL OUTLINE PACKAGE



4220763/A 05/2022

### NOTES:

1. All linear dimensions are in millimeters. Any dimensions in parenthesis are for reference only. Dimensioning and tolerancing per ASME Y14.5M.
2. This drawing is subject to change without notice.
3. This dimension does not include mold flash, protrusions, or gate burrs. Mold flash, protrusions, or gate burrs shall not exceed 0.15 mm per side.
4. Reference JEDEC registration MO-150.

# EXAMPLE BOARD LAYOUT

DB0016A

SSOP - 2 mm max height

SMALL OUTLINE PACKAGE



LAND PATTERN EXAMPLE  
EXPOSED METAL SHOWN  
SCALE: 10X



4220763/A 05/2022

NOTES: (continued)

- 5. Publication IPC-7351 may have alternate designs.
- 6. Solder mask tolerances between and around signal pads can vary based on board fabrication site.

# EXAMPLE STENCIL DESIGN

DB0016A

SSOP - 2 mm max height

SMALL OUTLINE PACKAGE



SOLDER PASTE EXAMPLE  
BASED ON 0.125 mm THICK STENCIL  
SCALE: 10X

4220763/A 05/2022

NOTES: (continued)

7. Laser cutting apertures with trapezoidal walls and rounded corners may offer better paste release. IPC-7525 may have alternate design recommendations.
8. Board assembly site may have different recommendations for stencil design.

## IMPORTANT NOTICE AND DISCLAIMER

TI PROVIDES TECHNICAL AND RELIABILITY DATA (INCLUDING DATA SHEETS), DESIGN RESOURCES (INCLUDING REFERENCE DESIGNS), APPLICATION OR OTHER DESIGN ADVICE, WEB TOOLS, SAFETY INFORMATION, AND OTHER RESOURCES "AS IS" AND WITH ALL FAULTS, AND DISCLAIMS ALL WARRANTIES, EXPRESS AND IMPLIED, INCLUDING WITHOUT LIMITATION ANY IMPLIED WARRANTIES OF MERCHANTABILITY, FITNESS FOR A PARTICULAR PURPOSE OR NON-INFRINGEMENT OF THIRD PARTY INTELLECTUAL PROPERTY RIGHTS.

These resources are intended for skilled developers designing with TI products. You are solely responsible for (1) selecting the appropriate TI products for your application, (2) designing, validating and testing your application, and (3) ensuring your application meets applicable standards, and any other safety, security, regulatory or other requirements.

These resources are subject to change without notice. TI grants you permission to use these resources only for development of an application that uses the TI products described in the resource. Other reproduction and display of these resources is prohibited. No license is granted to any other TI intellectual property right or to any third party intellectual property right. TI disclaims responsibility for, and you will fully indemnify TI and its representatives against, any claims, damages, costs, losses, and liabilities arising out of your use of these resources.

TI's products are provided subject to [TI's Terms of Sale](#) or other applicable terms available either on [ti.com](https://www.ti.com) or provided in conjunction with such TI products. TI's provision of these resources does not expand or otherwise alter TI's applicable warranties or warranty disclaimers for TI products.

TI objects to and rejects any additional or different terms you may have proposed.

Mailing Address: Texas Instruments, Post Office Box 655303, Dallas, Texas 75265  
Copyright © 2024, Texas Instruments Incorporated