

## ADC1173 8-Bit, 3-Volt, 15MSPS, 33mW A/D Converter

Check for Samples: [ADC1173](#)

### FEATURES

- Internal Sample-and-Hold Function
- Single +3V Operation
- Internal Reference Bias Resistors
- Industry Standard Pinout

### APPLICATIONS

- Video Digitization
- Digital Still Cameras
- Set Top Boxes
- Camcorders
- Personal Computer Video
- Digital Television
- CCD Imaging
- Electro-Optics

### KEY SPECIFICATIONS

- Resolution 8 Bits
- Maximum Sampling Frequency 15 MSPS (min)
- THD  $-54$  dB (typ)
- DNL  $\pm 0.85$  LSB (max)
- ENOB at 3.58 MHz Input 7.6 Bits (typ)
- Differential Phase 0.5 Degree (max)
- Differential Gain 1.5% (typ)
- Power Consumption 33 mW (typ) (excluding reference current)

### DESCRIPTION

The ADC1173 is a low power, 15 MSPS analog-to-digital converter that digitizes signals to 8 bits while consuming just 33 mW of power (typ). The ADC1173 uses a unique architecture that achieves 7.6 Effective Bits. Output formatting is straight binary coding.

The excellent DC and AC characteristics of this device, together with its low power consumption and +3V single supply operation, make it ideally suited for many video, imaging and communications applications, including use in portable equipment. Furthermore, the ADC1173 is resistant to latch-up and the outputs are short-circuit proof. The top and bottom of the ADC1173's reference ladder is available for connections, enabling a wide range of input possibilities.

The ADC1173 is offered in a 24-pin TSSOP package and is designed to operate over the  $-40^{\circ}\text{C}$  to  $+75^{\circ}\text{C}$  commercial temperature range.

### PIN CONFIGURATION

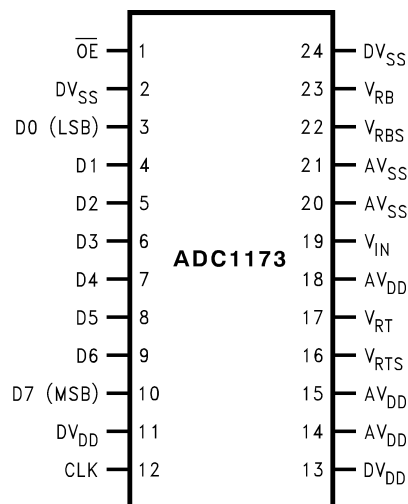

**Figure 1. 24-Pin TSSOP (Top View)  
See PW Package**



Please be aware that an important notice concerning availability, standard warranty, and use in critical applications of Texas Instruments semiconductor products and disclaimers thereto appears at the end of this data sheet.

All trademarks are the property of their respective owners.

**BLOCK DIAGRAM**

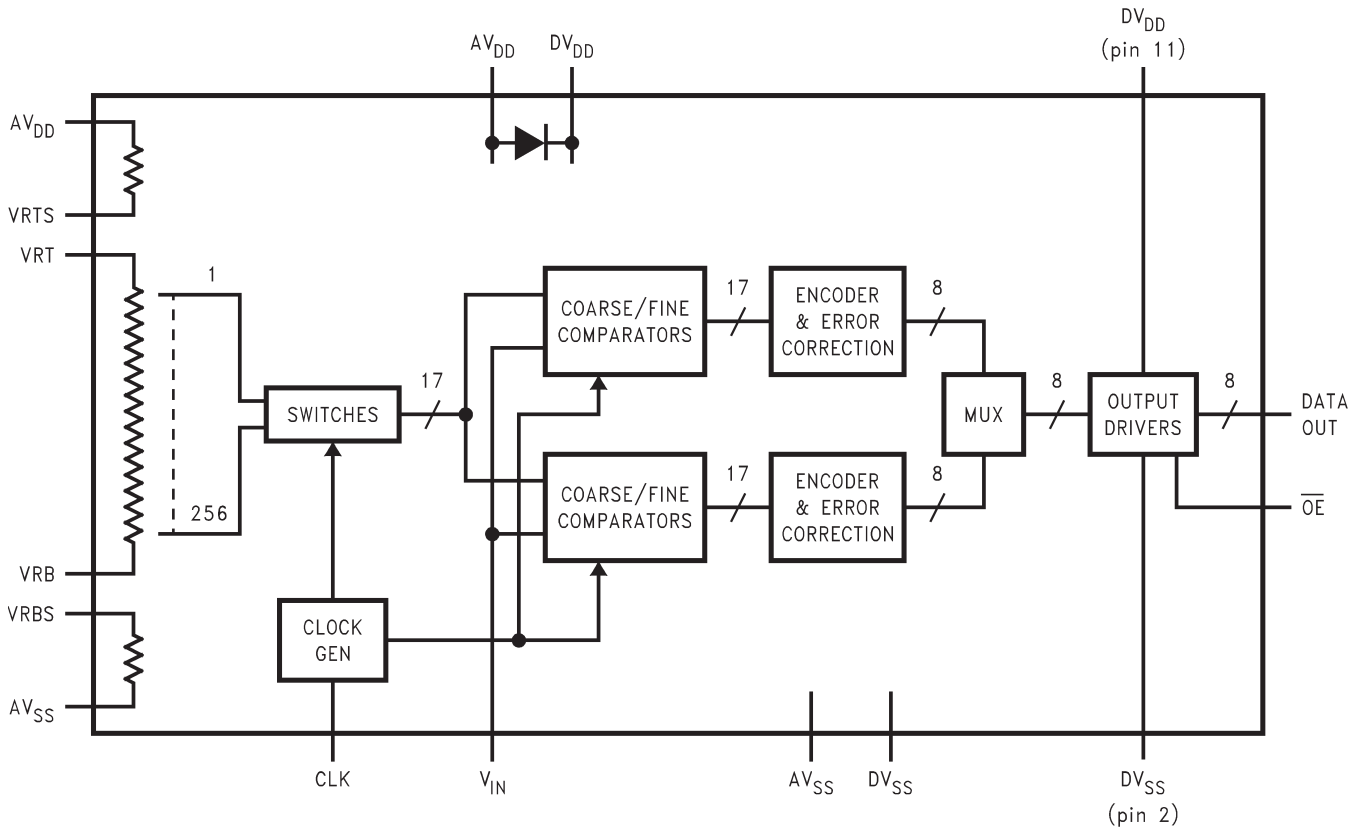

PIN DESCRIPTIONS AND EQUIVALENT CIRCUITS

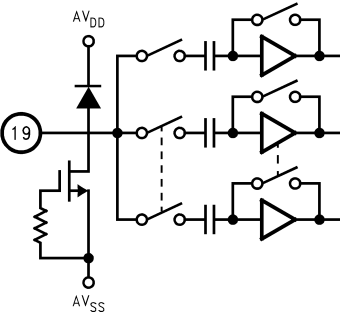
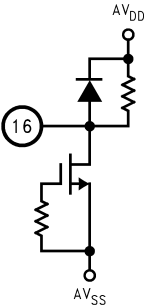
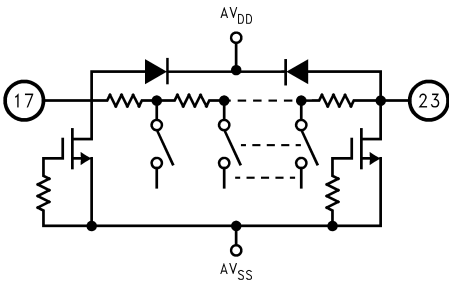
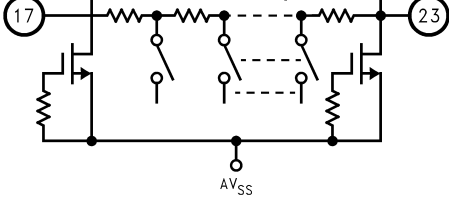
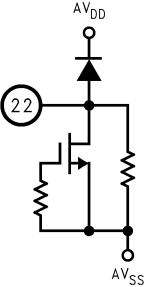
Pin No.	Symbol	Equivalent Circuit	Description
19	$V_{IN}$		Analog signal input. Conversion range is $V_{RB}$ to $V_{RT}$ .
16	$V_{RTS}$		Reference Top Bias with internal pull-up resistor. Short this pin to $V_{RT}$ to self bias the reference ladder.
17	$V_{RT}$		Analog Input that is the high (top) side of the reference ladder of the ADC. Nominal range is 1.0V to $AV_{DD}$ . Voltage on $V_{RT}$ and $V_{RB}$ inputs define the $V_{IN}$ conversion range. Bypass well. For more information, see <a href="#">REFERENCE INPUTS</a> .
23	$V_{RB}$		Analog Input that is the low (bottom) side of the reference ladder of the ADC. Nominal range is 0V to 2.0V. Voltage on $V_{RT}$ and $V_{RB}$ inputs define the $V_{IN}$ conversion range. Bypass well. For more information, see <a href="#">REFERENCE INPUTS</a> .
22	$V_{RBS}$		Reference Bottom Bias with internal pull down resistor. Short to $V_{RB}$ to self bias the reference ladder.

**PIN DESCRIPTIONS AND EQUIVALENT CIRCUITS (continued)**

Pin No.	Symbol	Equivalent Circuit	Description
1	$\overline{OE}$		CMOS/TTL compatible Digital input that, when low, enables the digital outputs of the ADC1173. When high, the outputs are in a high impedance state.
12	CLK		CMOS/TTL compatible digital clock Input. $V_{IN}$ is sampled on the falling edge of CLK input.
3 thru 10	D0-D7		Conversion data digital Output pins. D0 is the LSB, D7 is the MSB. Valid data is output just after the rising edge of the CLK input. These pins are enabled by bringing the $\overline{OE}$ pin low.
11, 13	DVDD		Positive digital supply pin. Connect to a clean, quiet voltage source of +3V. $AV_{DD}$ and $DV_{DD}$ should have a common source and be separately bypassed with a 10 $\mu$ F capacitor and a 0.1 $\mu$ F ceramic chip capacitor. For more information, see <a href="#">POWER SUPPLY CONSIDERATIONS</a> .
2, 24	DVSS		The ground return for the digital supply. $AV_{SS}$ and $DV_{SS}$ should be connected together close to the ADC1173.
14, 15, 18	AVDD		Positive analog supply pin. Connected to a clean, quiet voltage source of +3V. $AV_{DD}$ and $DV_{DD}$ should have a common source and be separately bypassed with a 10 $\mu$ F capacitor and a 0.1 $\mu$ F ceramic chip capacitor. For more information, see <a href="#">POWER SUPPLY CONSIDERATIONS</a> .
20, 21	AVSS		The ground return for the analog supply. $AV_{SS}$ and $DV_{SS}$ should be connected together close to the ADC1173 package.



These devices have limited built-in ESD protection. The leads should be shorted together or the device placed in conductive foam during storage or handling to prevent electrostatic damage to the MOS gates.

**ABSOLUTE MAXIMUM RATINGS**<sup>(1)(2)(3)</sup>

$AV_{DD}$ , $DV_{DD}$		6.5V
Voltage on Any Pin		-0.3V to 6.5V
$V_{RT}$ , $V_{RB}$		$AV_{DD}$ to $V_{SS}$
CLK, $\overline{OE}$ Voltage		-0.5 to ( $AV_{DD}$ + 0.5V)
Digital Output Voltage		$DV_{SS}$ to $DV_{DD}$
Input Current <sup>(4)</sup>		±25mA
Package Input Current <sup>(4)</sup>		±50mA
Package Dissipation at 25°C		See <sup>(5)</sup>
ESD Susceptibility <sup>(6)</sup>	Human Body Model	2000V
	Machine Model	200V
Soldering Temp., Infrared, 10 sec.		300°C
Storage Temperature		-65°C to +150°C

- (1) Absolute Maximum Ratings indicate limits beyond which damage to the device may occur. Operating Ratings indicate conditions for which the device is functional, but do not ensure specific performance limits. For ensured specifications and test conditions, see the Electrical Characteristics. The ensured specifications apply only for the test conditions listed. Some performance characteristics may degrade when the device is not operated under the listed test conditions.
- (2) All voltages are measured with respect to GND =  $AV_{SS}$  =  $DV_{SS}$  = 0V, unless otherwise specified.
- (3) If Military/Aerospace specified devices are required, please contact the Texas Instruments Sales Office/Distributors for availability and specifications.
- (4) When the input voltage at any pin exceeds the power supplies (that is, less than  $AV_{SS}$  or  $DV_{SS}$ , or greater than  $AV_{DD}$  or  $DV_{DD}$ ), the current at that pin should be limited to 25 mA. The 50 mA maximum package input current rating limits the number of pins that can safely exceed the power supplies with an input current of 25 mA to two.
- (5) The absolute maximum junction temperatures ( $T_{Jmax}$ ) for this device is 150°C. The maximum allowable power dissipation is dictated by  $T_{Jmax}$ , the junction-to-ambient thermal resistance  $\theta_{JA}$ , and the ambient temperature,  $T_A$ , and can be calculated using the formula  $P_{DMAX} = (T_{Jmax} - T_A) / \theta_{JA}$ . The power dissipation of this device under normal operation will typically be much lower than that required to raise the junction temperature enough to be a problem. The values for maximum power dissipation listed above will be reached only when the ADC1173 is operated in a severe fault condition (e.g. when input or output pins are driven beyond the power supply voltages, or the power supply polarity is reversed). Obviously, such conditions should always be avoided.
- (6) Human body model is 100 pF capacitor discharged through a 1.5k $\Omega$  resistor. Machine model is 220 pF discharged through ZERO  $\Omega$ .

**OPERATING RATINGS**<sup>(1)(2)</sup>

Temperature Range		$-40^{\circ}\text{C} \leq T_A \leq +75^{\circ}\text{C}$
$AV_{DD}$ , $DV_{DD}$		+2.7V to +3.6V
$ AV_{SS} - DV_{SS} $		0V to 100 mV
$V_{RT}$		1.0V to $AV_{DD}$
$V_{RB}$		0V to 2.0V
$V_{RT} - V_{RB}$		1.0V to 2.8V
$V_{IN}$ Voltage Range		$V_{RB}$ to $V_{RT}$

- (1) Absolute Maximum Ratings indicate limits beyond which damage to the device may occur. Operating Ratings indicate conditions for which the device is functional, but do not ensure specific performance limits. For ensured specifications and test conditions, see the Electrical Characteristics. The ensured specifications apply only for the test conditions listed. Some performance characteristics may degrade when the device is not operated under the listed test conditions.
- (2) All voltages are measured with respect to GND =  $AV_{SS}$  =  $DV_{SS}$  = 0V, unless otherwise specified.

## CONVERTER ELECTRICAL CHARACTERISTICS

The following specifications apply for  $AV_{DD} = DV_{DD} = +3.0V_{DC}$ ,  $\overline{OE} = 0V$ ,  $V_{RT} = +2.0V$ ,  $V_{RB} = 0V$ ,  $C_L = 20\text{ pF}$ ,  $f_{CLK} = 15\text{ MHz}$  at 50% duty cycle. **Boldface limits apply for  $T_A = T_{MIN}$  to  $T_{MAX}$** ; all other limits  $T_A = 25^\circ\text{C}$  <sup>(1)</sup> <sup>(2)</sup>

Symbol	Parameter	Conditions	Typical <sup>(3)</sup>	Limits	Units
<b>DC Accuracy</b>					
INL	Integral Non Linearity		$\pm 0.5$	<b><math>\pm 1.3</math></b>	LSB ( max)
DNL	Differential Non Linearity		$\pm 0.4$	<b><math>\pm 0.85</math></b>	LSB ( max)
	Missing Codes			<b>0</b>	(max)
$E_{OT}$	Top Offset		-12		mV
$E_{OB}$	Bottom Offset		+1.0		mV
<b>Video Accuracy</b>					
DP	Differential Phase Error	$f_{in} = 3.58\text{ MHz sine wave}$	0.5		Degree
DG	Differential Gain Error	$f_{in} = 3.58\text{ MHz sine wave}$	1.5		%
<b>Analog Input and Reference Characteristics</b>					
$V_{IN}$	Input Range		2.0	$V_{RB}$ $V_{RT}$	V (min) V (max)
$C_{IN}$	$V_{IN}$ Input Capacitance	$V_{IN} = 1.5V + 0.7V_{rms}$	(CLK LOW)	4	pF
			(CLK HIGH)	11	
$R_{IN}$	Input Resistance		>1		M $\Omega$
BW	Analog Input Bandwidth		120		MHz
$R_{RT}$	Top Reference Resistor		360		$\Omega$
$R_{REF}$	Reference Ladder Resistance	$V_{RT}$ to $V_{RB}$	300	200 400	$\Omega$ (min) $\Omega$ (max)
$R_{RB}$	Bottom Reference Resistor		90		$\Omega$
$I_{REF}$	Reference Ladder Current	$V_{RT} = V_{RTS}$ , $V_{RB} = V_{RBS}$	4.2		mA
		$V_{RT} = V_{RTS}$ , $V_{RB} = AV_{SS}$	4.8		mA
$V_{RT}$	Reference Top Self Bias Voltage	$V_{RT}$ connected to $V_{RTS}$ $V_{RB}$ connected to $V_{RBS}$	1.56	<b>1.45</b> <b>1.65</b>	V (min) V (max)
$V_{RB}$	Reference Bottom Self Bias Voltage	$V_{RT}$ connected to $V_{RTS}$ $V_{RB}$ connected to $V_{RBS}$	0.36	<b>0.32</b> <b>0.40</b>	V (min) V (max)

- (1) The analog inputs are protected as shown below. Input voltage magnitudes up to 6.5V or to 500 mV below GND will not damage this device. However, errors in the A/D conversion can occur if the input goes above  $V_{DD}$  or below GND by more than 50 mV. As an example, if  $AV_{DD}$  is  $2.7V_{DC}$ , the full-scale input voltage must be  $\leq 2.75V_{DC}$  to ensure accurate conversions.

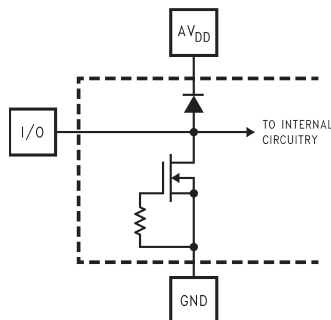

- (2) To ensure accuracy, it is required that  $AV_{DD}$  and  $DV_{DD}$  be well bypassed. Each supply pin must be decoupled with separate bypass capacitors.
- (3) Typical figures are at  $T_J = 25^\circ\text{C}$ , and represent most likely parametric norms. Test limits are ensured to TI's AOQL (Average Outgoing Quality Level).

**CONVERTER ELECTRICAL CHARACTERISTICS (continued)**

The following specifications apply for  $V_{DD} = DV_{DD} = +3.0V_{DC}$ ,  $\overline{OE} = 0V$ ,  $V_{RT} = +2.0V$ ,  $V_{RB} = 0V$ ,  $C_L = 20\text{ pF}$ ,  $f_{CLK} = 15\text{ MHz}$  at 50% duty cycle. **Boldface limits apply for  $T_A = T_{MIN}$  to  $T_{MAX}$** ; all other limits  $T_A = 25^\circ\text{C}$  <sup>(1) (2)</sup>

Symbol	Parameter	Conditions	Typical <sup>(3)</sup>	Limits	Units
$V_{RTS} - V_{RBS}$	Self Bias Voltage Delta	$V_{RT}$ connected to $V_{RTS}$ , $V_{RB}$ connected to $V_{RBS}$	1.2	<b>1.1</b> <b>1.3</b>	$\mu\text{A}$ (min) $\mu\text{A}$ (max)
		$V_{RT}$ connected to $V_{RTS}$ , $V_{RB}$ connected to $V_{SS}$	1.38		V
$V_{RT} - V_{RB}$	Reference Voltage Delta		2	<b>1.0</b> <b><math>V_A</math></b>	V (min) V (max)
<b>Power Supply Characteristics</b>					
$I_{ADD}$	Analog Supply Current	$DV_{DD} = AV_{DD} = 3.6V$	6.8		mA
$I_{DD}$	Digital Supply Current	$DV_{DD} = AV_{DD} = 3.6V$	2.3		mA
$I_{AV_{DD}} + I_{DV_{DD}}$	Total Operating Current	$DV_{DD} = AV_{DD} = 3.6V$ ,	9.1	<b>11.4</b>	mA
		$DV_{DD} = AV_{DD} = 3.6V$ , CLK Low <sup>(4)</sup>	5.8		mA
	Power Consumption	$DV_{DD} = AV_{DD} = 3.6V$	33	<b>41</b>	mW
<b>CLK, <math>\overline{OE}</math> Digital Input Characteristics</b>					
$V_{IH}$	Logical High Input Voltage	$DV_{DD} = AV_{DD} = 3.6V$		<b>2.2</b>	V (min)
$V_{IL}$	Logical Low Input Voltage	$DV_{DD} = AV_{DD} = 3.6V$		<b>0.8</b>	V (max)
$I_{IH}$	Logical High Input Current	$V_{IH} = DV_{DD} = AV_{DD} = 3.6V$	5		$\mu\text{A}$
$I_{IL}$	Logic Low Input Current	$V_{IL} = 0V$ , $DV_{DD} = AV_{DD} = 3.6V$	-5		$\mu\text{A}$
$C_{IN}$	Logic Input Capacitance		5		pF
<b>Digital Output Characteristics</b>					
$V_{OH}$	High Level Output Voltage	$DV_{DD} = 2.7V$ , $I_{OH} = -360\mu\text{A}$	2.4		V (min)
		$DV_{DD} = 2.7V$ , $I_{OH} = -1.1\text{mA}$	2.1	<b>1.9</b>	V (min)
$V_{OL}$	Low Level Output Voltage	$DV_{DD} = 2.7V$ , $I_{OL} = 1.6\text{mA}$	0.32	<b>0.6</b>	V (max)
$I_{OZH}$ , $I_{OZL}$	TRI-STATE Leakage Current	$DV_{DD} = 3.6V$ , $\overline{OE} = DV_{DD}$ , $V_{OL} = 0V$ or $V_{OH} = DV_{DD}$	$\pm 20$		$\mu\text{A}$
<b>AC Electrical Characteristics</b>					
$f_{C1}$	Maximum Conversion Rate		20	<b>15</b>	MHz (min)
$f_{C2}$	Minimum Conversion Rate		1		MHz
$t_{OD}$	Output Delay	CLK rise to data rising	28		ns
		CLK rise to data falling	24		ns
	Pipeline Delay (Latency)		2.5		Clock Cycles
$t_{DS}$	Sampling (Aperture) Delay	CLK low to acquisition of data	3		ns
$t_{AJ}$	Aperture Jitter		30		ps rms
$t_{OH}$	Output Hold Time	CLK high to data invalid	15		ns
$t_{EN}$	$\overline{OE}$ Low to Data Valid	Loaded as in <a href="#">Figure 25</a>	22		ns
$t_{DIS}$	$\overline{OE}$ High to High Z State	Loaded as in <a href="#">Figure 25</a>	12		ns
ENOB	Effective Number of Bits	$f_{IN} = 1.31\text{ MHz}$	7.7	<b>7.0</b>	Bits (min)
		$f_{IN} = 3.58\text{ MHz}$	7.6		
		$f_{IN} = 7.5\text{ MHz}$	7.4		
SINAD	Signal-to- Noise & Distortion	$f_{IN} = 1.31\text{ MHz}$	49	<b>43</b>	dB (min)
		$f_{IN} = 3.58\text{ MHz}$	47.7		
		$f_{IN} = 7.5\text{ MHz}$	46.5		
SNR	Signal-to-Noise Ratio	$f_{IN} = 1.31\text{ MHz}$	49	<b>44</b>	dB (min)
		$f_{IN} = 3.58\text{ MHz}$	48.7		
		$f_{IN} = 7.5\text{ MHz}$	48.0		
SFDR	Spurious Free Dynamic Range	$f_{IN} = 1.31\text{ MHz}$	65		dB
		$f_{IN} = 3.58\text{ MHz}$	55		
		$f_{IN} = 7.5\text{ MHz}$	51		

(4) At least two clock cycles must be presented to the ADC1173 after power up. For details, see [THE ADC1173 CLOCK](#).

### CONVERTER ELECTRICAL CHARACTERISTICS (continued)

The following specifications apply for  $AV_{DD} = DV_{DD} = +3.0V_{DC}$ ,  $\overline{OE} = 0V$ ,  $V_{RT} = +2.0V$ ,  $V_{RB} = 0V$ ,  $C_L = 20\text{ pF}$ ,  $f_{CLK} = 15\text{ MHz}$  at 50% duty cycle. **Boldface limits apply for  $T_A = T_{MIN}$  to  $T_{MAX}$** ; all other limits  $T_A = 25^\circ\text{C}$  <sup>(1)</sup> <sup>(2)</sup>

Symbol	Parameter	Conditions	Typical <sup>(3)</sup>	Limits	Units
THD	Total Harmonic Distortion	$f_{IN} = 1.31\text{ MHz}$ $f_{IN} = 3.58\text{ MHz}$ $f_{IN} = 7.5\text{ MHz}$	-62 -54 -51		dB



TYPICAL PERFORMANCE CHARACTERISTICS

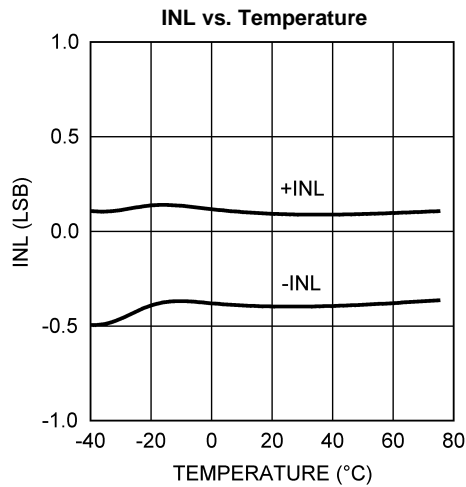

Figure 2.

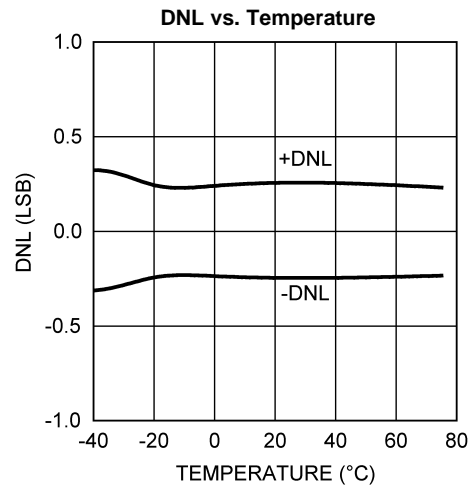

Figure 3.

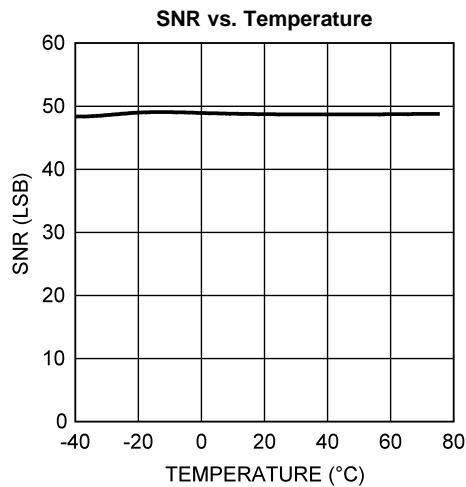

Figure 4.

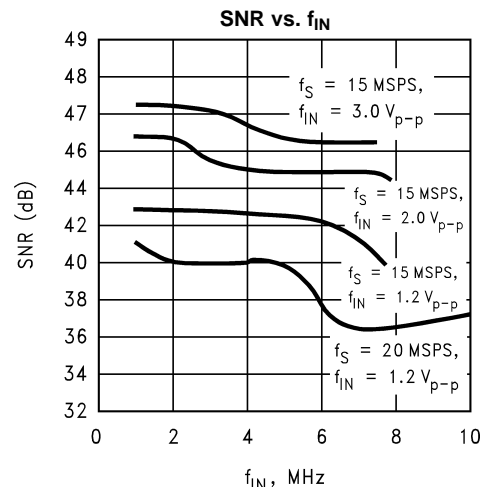

Figure 5.

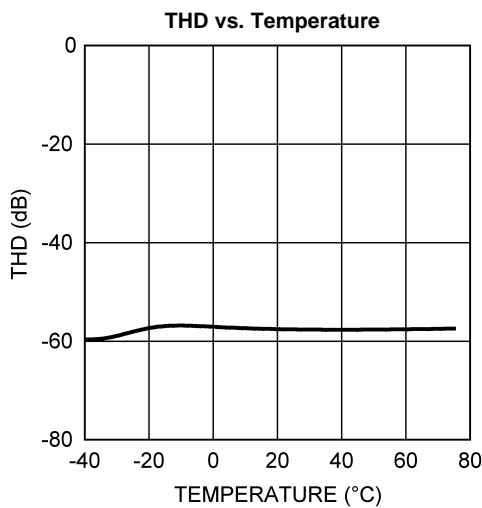

Figure 6.

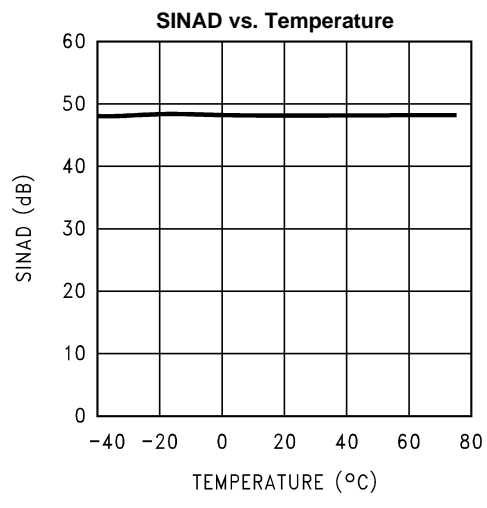

Figure 7.

**TYPICAL PERFORMANCE CHARACTERISTICS (continued)**

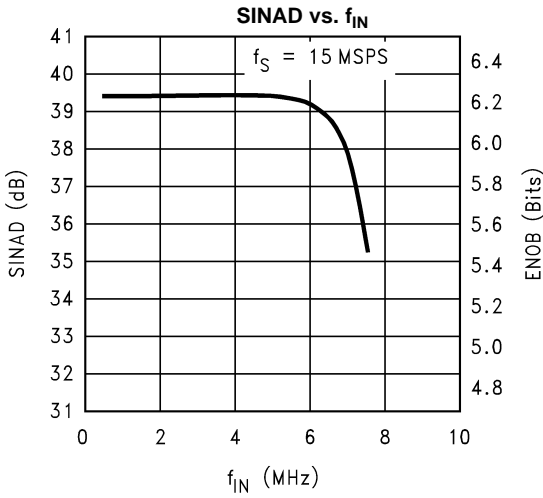

Figure 8.

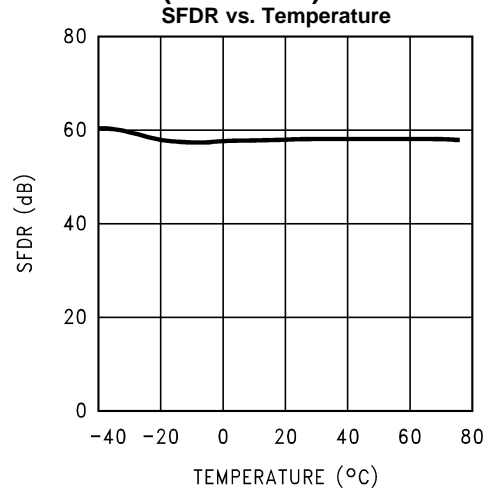

Figure 9.

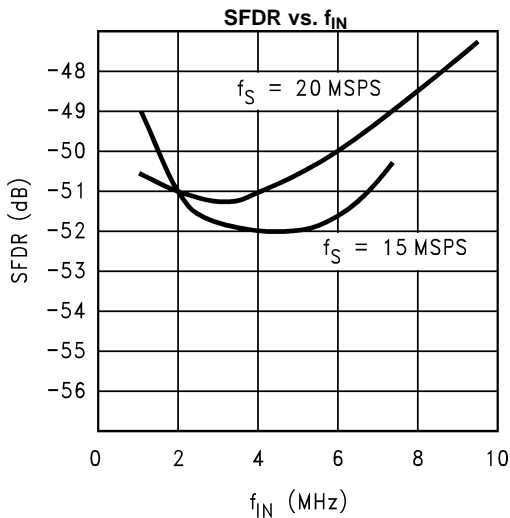

Figure 10.

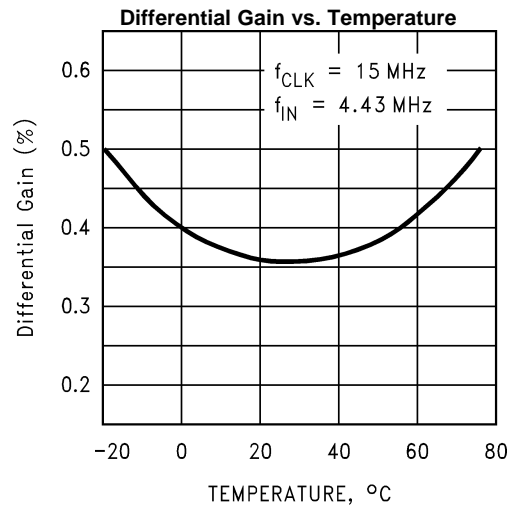

Figure 11.

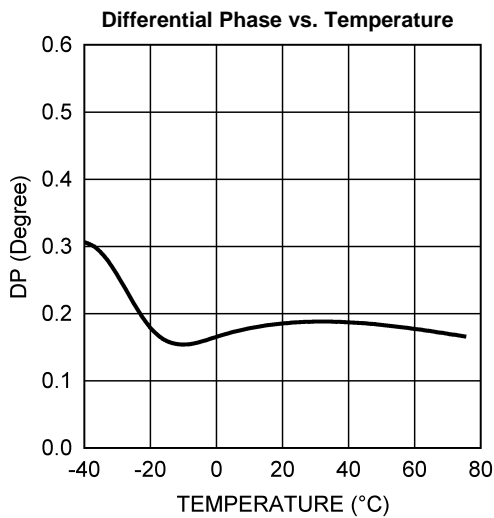

Figure 12.

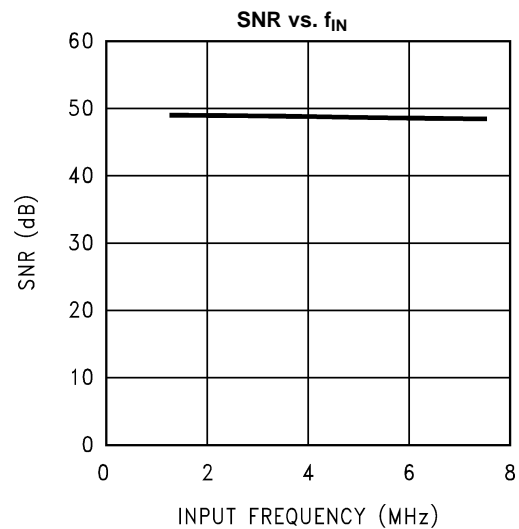

Figure 13.

**TYPICAL PERFORMANCE CHARACTERISTICS (continued)**

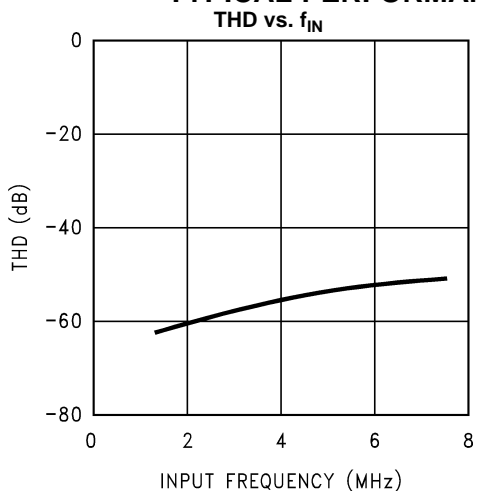

Figure 14.

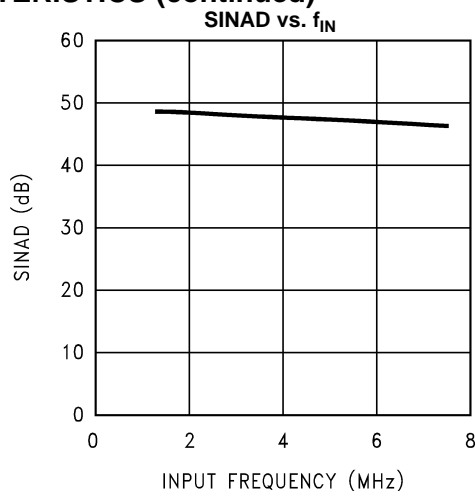

Figure 15.

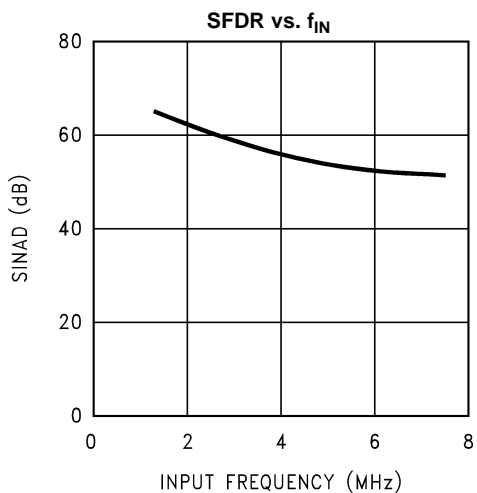

Figure 16.

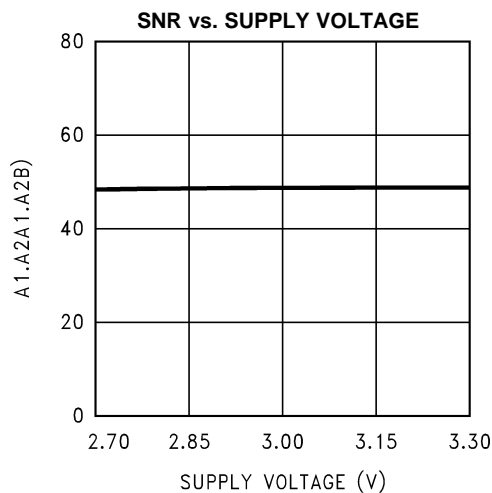

Figure 17.

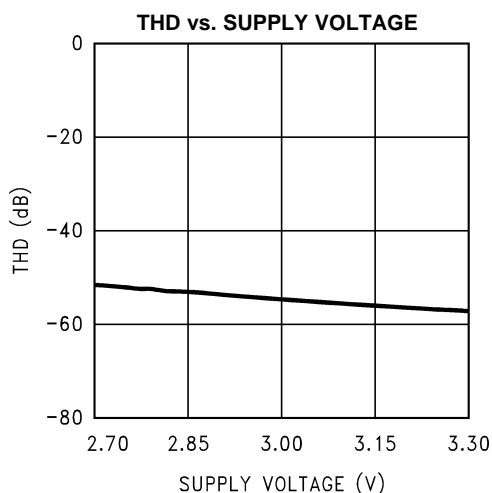

Figure 18.

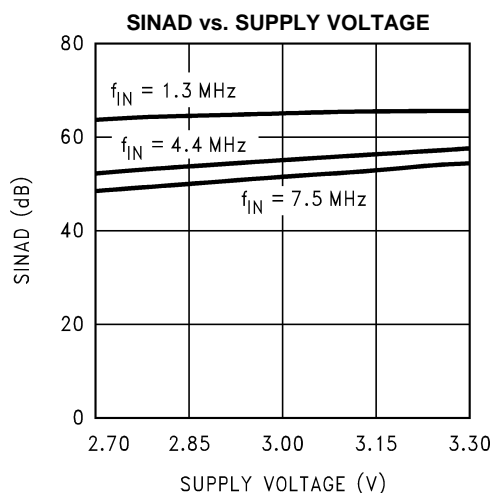

Figure 19.

**TYPICAL PERFORMANCE CHARACTERISTICS (continued)**

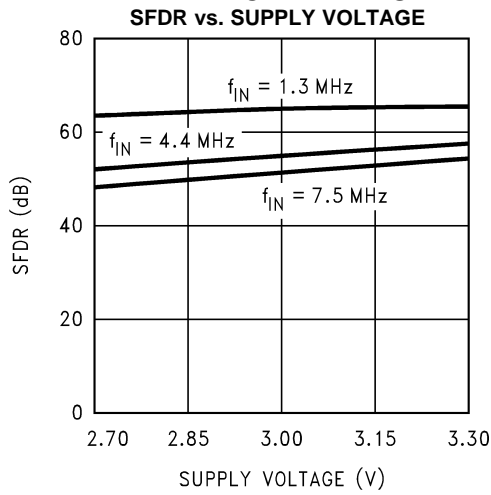

Figure 20.

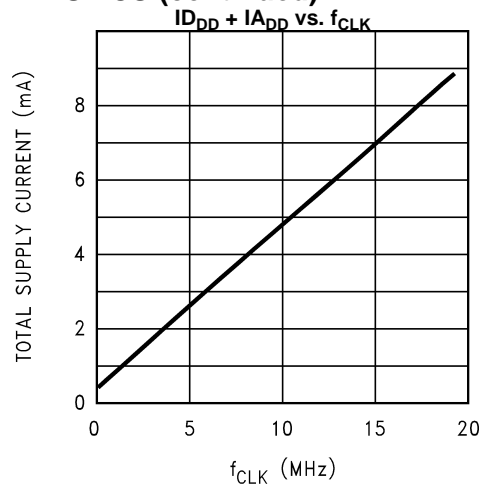

Figure 21.

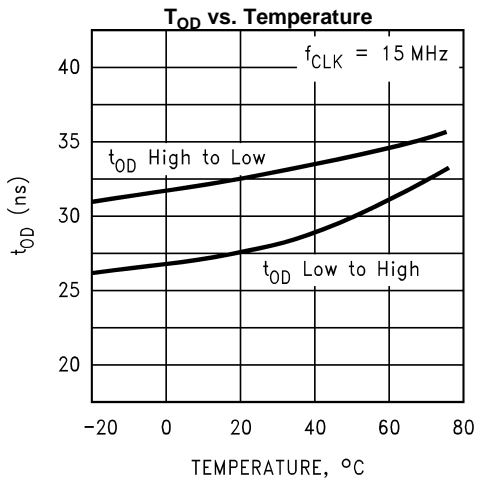

Figure 22.

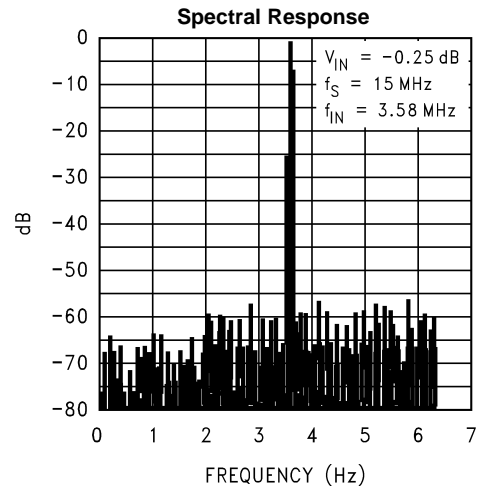

Figure 23.

## SPECIFICATION DEFINITIONS

**ANALOG INPUT BANDWIDTH** is a measure of the frequency at which the reconstructed output fundamental drops 3 dB below its low frequency value for a full scale input. The test is performed with  $f_{IN}$  equal to 100 kHz plus integer multiples of  $f_{CLK}$ . The input frequency at which the output is -3 dB relative to the low frequency input signal is the full power bandwidth.

**APERTURE JITTER** is the time uncertainty of the sampling point ( $t_{DS}$ ), or the range of variation in the sampling delay.

**BOTTOM OFFSET** is the difference between the input voltage that just causes the output code to transition to the first code and the negative reference voltage. Bottom offset is defined as  $E_{OB} = V_{ZT} - V_{RB}$ , where  $V_{ZT}$  is the first code transition input voltage. Note that this is different from the normal Zero Scale Error.

**DIFFERENTIAL GAIN ERROR** is the percentage difference between the output amplitudes of a high frequency reconstructed sine wave at two different DC levels.

**DIFFERENTIAL NON-LINEARITY (DNL)** is the measure of the maximum deviation from the ideal step size of 1 LSB.

**DIFFERENTIAL PHASE ERROR** is the difference in the output phase of a reconstructed small signal sine wave at two different DC levels.

**EFFECTIVE NUMBER OF BITS (ENOB, or EFFECTIVE BITS)** is another method of specifying Signal-to-Noise and Distortion Ratio, or SINAD. ENOB is defined as  $(SINAD - 1.76) / 6.02$  and says that the converter is equivalent to a perfect ADC of this (ENOB) number of bits.

**INTEGRAL NON-LINEARITY (INL)** is a measure of the deviation of each individual code from a line drawn from zero scale ( $\frac{1}{2}$ LSB below the first code transition) through positive full scale ( $\frac{1}{2}$ LSB above the last code transition). The deviation of any given code from this straight line is measured from the center of that code value. The end point test method is used.

**OUTPUT DELAY** is the time delay after the rising edge of the input clock before the data update is present at the output pins.

**OUTPUT HOLD TIME** is the length of time that the output data is valid after the rise of the input clock.

**PIPELINE DELAY (LATENCY)** is the number of clock cycles between initiation of conversion and the availability of that conversion result at the output. New data is available at every clock cycle, but the data lags the conversion by the pipeline delay.

**SAMPLING (APERTURE) DELAY** is that time required after the fall of the clock input for the sampling switch to open. The Sample/Hold circuit effectively stops capturing the input signal and goes into the "hold" mode  $t_{DS}$  after the clock goes low.

**SIGNAL TO NOISE RATIO (SNR)** is the ratio of the rms value of the input signal to the rms value of the other spectral components below one-half the sampling frequency, not including harmonics or DC.

**SIGNAL TO NOISE PLUS DISTORTION (S/(N+D) or SINAD)** is the ratio of the rms value of the input signal to the rms value of all of the other spectral components below half the clock frequency, including harmonics but excluding DC.

**SPURIOUS FREE DYNAMIC RANGE (SFDR)** is the difference, expressed in dB, between the rms values of the input signal and the peak spurious signal, where a spurious signal is any signal present in the output spectrum that is not present at the input.

**TOP OFFSET** is the difference between the positive reference voltage and the input voltage that just causes the output code to transition to full scale and is defined as  $E_{OT} = V_{FT} - V_{RT}$ . Where  $V_{FT}$  is the full scale transition input voltage. Note that this is different from the normal Full Scale Error.

**TOTAL HARMONIC DISTORTION (THD)** is the ratio of the rms total of the first six harmonic components, to the rms value of the input signal.

Timing Diagram

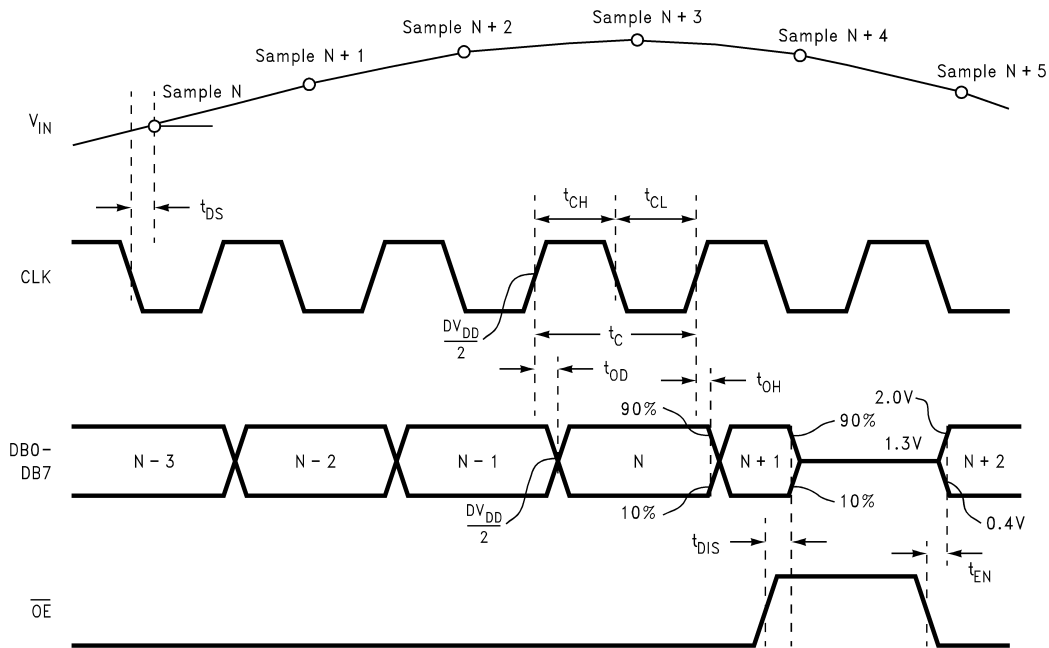
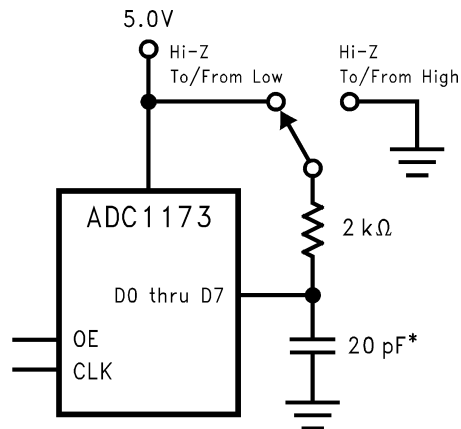

Figure 24. Timing Diagram



\* Includes stray and distributed capacitance

Figure 25.  $t_{EN}$ ,  $t_{DIS}$  Test Circuit

## FUNCTIONAL DESCRIPTION

The ADC1173 uses a new, unique architecture to achieve 7.4 effective bits at and maintains superior dynamic performance up to  $\frac{1}{2}$  the clock frequency.

The analog signal at  $V_{IN}$  that is within the voltage range set by  $V_{RT}$  and  $V_{RB}$  are digitized to eight bits at up to 20 MSPS. Input voltages below  $V_{RB}$  will cause the output word to consist of all zeroes. Input voltages above  $V_{RT}$  will cause the output word to consist of all ones.  $V_{RT}$  has a range of 1.0 Volt to the analog supply voltage,  $AV_{DD}$ , while  $V_{RB}$  has a range of 0 to 2.0 Volts.  $V_{RT}$  should always be at least 1.0 Volt more positive than  $V_{RB}$ .

If  $V_{RT}$  and  $V_{RTS}$  are connected together and  $V_{RB}$  and  $V_{RBS}$  are connected together, the nominal values of  $V_{RT}$  and  $V_{RB}$  are 1.56V and 0.36V, respectively. If  $V_{RT}$  and  $V_{RTS}$  are connected together and  $V_{RB}$  is grounded, the nominal value of  $V_{RT}$  is 1.38V.

Data is acquired at the falling edge of the clock and the digital equivalent of the data is available at the digital outputs the pipeline delay (2.5 clock cycles) plus  $t_{OD}$  later. The ADC1173 will convert as long as the clock signal is present at pin 12. The Output Enable pin  $\overline{OE}$ , when low, enables the output pins. The digital outputs are in the high impedance state when the  $\overline{OE}$  pin is high.

## APPLICATIONS INFORMATION

### THE ANALOG INPUT

The analog input of the ADC1173 is a switch followed by an integrator. The input capacitance changes with the clock level, appearing as 4 pF when the clock is low, and 11 pF when the clock is high. Since a dynamic capacitance is more difficult to drive than a fixed capacitance, choose an amplifier that can drive this type of load. The LMH6702, LMH6609, LM6152, LM6154, LM6181 and LM6182 have been found to be excellent devices for driving the ADC1173. Do not drive the input beyond the supply rails.

shows an example of an input circuit using the LM6181. This circuit has both gain and offset adjustments. If you desire to eliminate these adjustments, you should reduce the signal swing to avoid clipping at the ADC1173 output that can result from normal tolerances of all system components. With no adjustments, the nominal value for the amplifier feedback resistor is 510 $\Omega$  and the 5.1k resistor at the inverting input should be changed to 860 $\Omega$  and returned to +3V rather than to the Offset Adjust potentiometer.

Driving the analog input with input signals up to 2.8V<sub>P-P</sub> will result in normal behavior where voltages above  $V_{RT}$  will result in a code of FFh and input voltages below  $V_{RB}$  will result in an output code of zero. Input signals above 2.8V<sub>P-P</sub> may result in odd behavior where the output code is not FFh when the input exceeds  $V_{RT}$ .

### REFERENCE INPUTS

The reference inputs  $V_{RT}$  (Reference Top) and  $V_{RB}$  (Reference Bottom) are the top and bottom of the reference ladder. Input signals between these two voltages will be digitized to 8 bits. External voltages applied to the reference input pins should be within the range specified in the Operating Ratings table (1.0V to  $A_{V_{DD}}$  for  $V_{RT}$  and 0V to ( $A_{V_{DD}} - 1.0V$ ) for  $V_{RB}$ ). Any device used to drive the reference pins should be able to source sufficient current into the  $V_{RT}$  pin and sink sufficient current from the  $V_{RB}$  pin.

The reference ladder can be self-biased by connecting  $V_{RT}$  to  $V_{RTS}$  and connecting  $V_{RB}$  to  $V_{RBS}$  to provide top and bottom reference voltages of approximately 1.56V and 0.36V, respectively, with  $V_{CC} = 3.0V$ . This connection is shown in [Figure 26](#). If  $V_{RT}$  and  $V_{RTS}$  are tied together, but  $V_{RB}$  is tied to analog ground, a top reference voltage of approximately 1.38V is generated. The top and bottom of the ladder should be bypassed with 10 $\mu$ F tantalum capacitors located close to the reference pins.



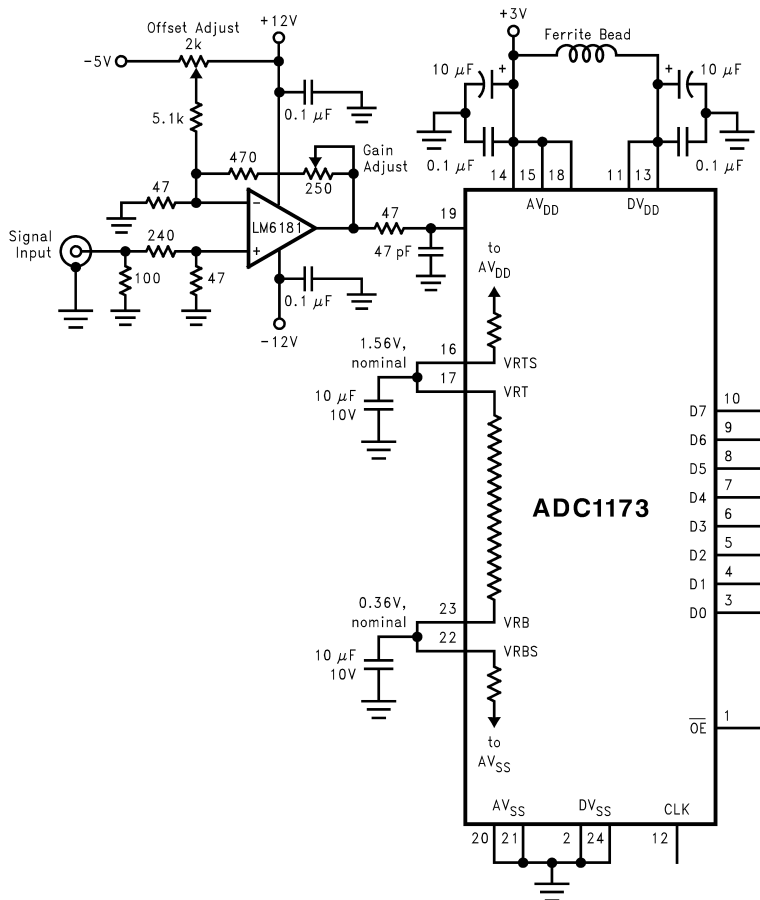

Because of resistor tolerances, the reference voltages can vary by as much as 6%. Choose an amplifier that can drive a dynamic capacitance (see text).

**Figure 26. Simple, Low Component Count, Self-Bias Reference application.**

The reference self-bias circuit of is very simple and performance is adequate for many applications. Superior performance can generally be achieved by driving the reference pins with a low impedance source.

By forcing a little current into or out of the top and bottom of the ladder, as shown in , the top and bottom reference voltages can be trimmed. The resistive divider at the amplifier inputs can be replaced with potentiometers. The LMC662 amplifier shown was chosen for its low offset voltage and low cost. Note that a negative power supply is needed for these amplifiers if their outputs are required to go slightly negative to force the required reference voltages.

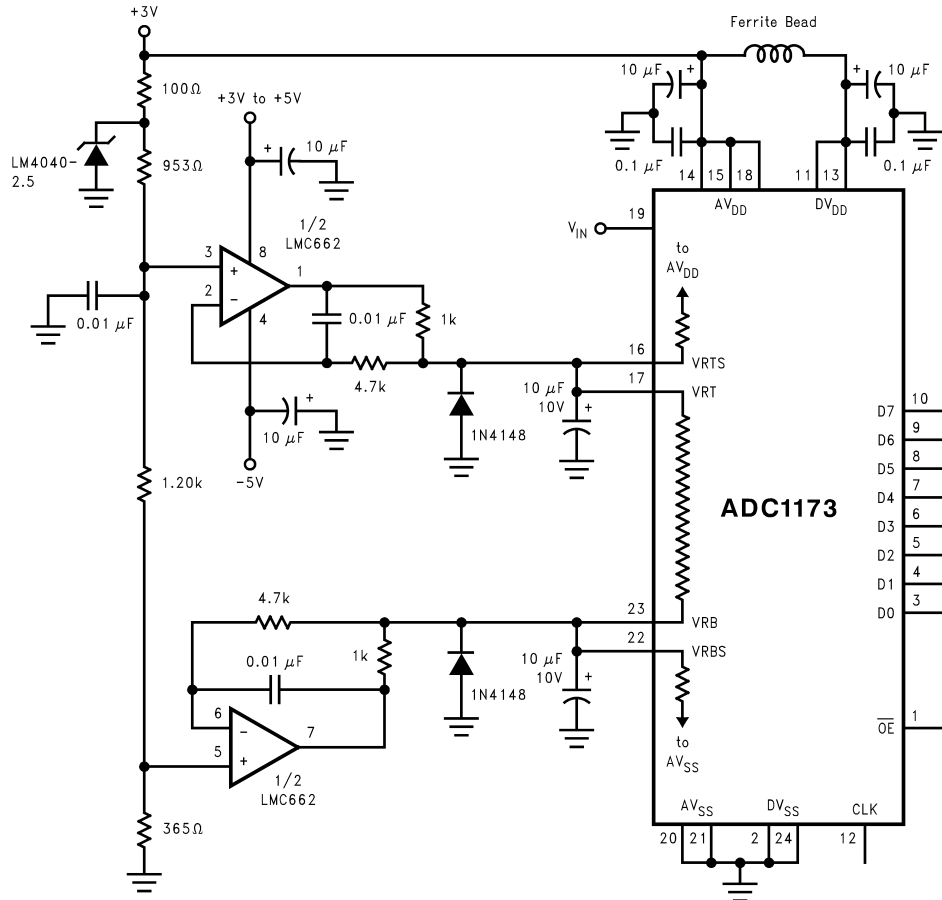

Self-bias is still used, but the reference voltages are trimmed by providing a small trim current with the operational amplifiers.

Figure 27. Better defining the ADC Reference Voltage.



As is the case with all high speed converters, the ADC1173 should be assumed to have little a.c. power supply rejection, especially when self-biasing is used by connecting  $V_{RT}$  and  $V_{RTS}$  together.

No pin should ever have a voltage on it that is in excess of the supply voltages or below ground, not even on a transient basis. This can be a problem upon application of power to a circuit. Be sure that the supplies to circuits driving the CLK,  $\overline{OE}$ , analog input and reference pins do not come up any faster than does the voltage at the ADC1173 power pins.

Pins 11 and 13 are both labeled  $DV_{DD}$ . Pin 11 is the supply point for the digital core of the ADC, where pin 13 is used only to provide power to the ADC output drivers. As such, pin 11 may be connected to a voltage source that is less than the +5V used for  $AV_{DD}$  and  $DV_{DD}$  to ease interfacing to low voltage devices. Pin 11 should never exceed the pin 13 potential by more than 0.5V. Note that  $t_{OD}$  will increase for lower pin 11 voltages.

## THE ADC1173 CLOCK

Although the ADC1173 is tested and its performance is ensured with a 15MHz clock, it typically will function with clock frequencies from 1MHz to 20MHz.

If continuous conversions are not required, power consumption can be reduced somewhat by stopping the clock at a logic low when the ADC1173 is not being used. This reduces the current drain in the ADC1173's digital circuitry from a typical value of 2.3mA to about 100 $\mu$ A.

Note that powering up the ADC1173 without the clock running may not save power, as it will result in an increased current flow (by as much as 170%) in the reference ladder. In some cases, this may increase the ladder current above the specified limit. Toggling the clock twice at 1MHz or higher and returning it to the low state will eliminate the excess ladder current.

An alternative power-saving technique is to power up the ADC1173 with the clock active, then halt the clock in the low state after two or more clock cycles. Stopping the clock in the high state is not recommended as a power-saving technique.

## LAYOUT AND GROUNDING

Proper grounding and proper routing of all signals is essential to ensure accurate conversion. Separate analog and digital ground planes that are connected beneath the ADC1173 may be used, but best EMI practices require a single ground plane. However, it is important to keep analog signal lines away from digital signal lines and away from power supply currents. This latter requirement requires the careful separation and placement of power planes. The use of power traces rather than one or more power planes is not recommended as higher frequencies are not well filtered with lumped capacitances. To filter higher frequency noise, it is necessary to have sufficient capacitance between the power and ground planes.

If separate analog and digital ground planes are used, the analog and digital grounds should be in the same layer, but should be separated from each other. If separate analog and digital ground layers are used, they should *never overlap* each other.

Capacitive coupling between a typically noisy digital ground plane and the sensitive analog circuitry can lead to poor performance that may seem impossible to isolate and remedy. The solution is to keep the analog circuitry well separated from the digital circuitry.

Digital circuits create substantial supply and ground current transients. The logic noise thus generated could have significant impact upon system noise performance. The best logic family to use in systems with A/D converters is one which employs non-saturating transistor designs, or has low noise characteristics, such as the 74HC(T) and 74AC(T)Q families. The worst noise generators are logic families that draw the largest supply current transients during clock or signal edges, like the 74F and the 74AC(T) families. In general, slower logic families, such as 74LS and 74HC(T), will produce less high frequency noise than do high speed logic families.

Since digital switching transients are composed largely of high frequency components, total ground plane copper weight will have little effect upon the logic-generated noise. This is because of the skin effect. Total surface area is more important than is total ground plane volume.

An effective way to control ground noise is by using a single, solid ground plane, splitting the power plane into analog and digital areas and to have power and ground planes in adjacent board layers. There should be no traces within either the power or the ground layers of the board. The analog and digital power planes should reside in the same board layer so that they can not overlap each other. The analog and digital power planes define the analog and digital areas of the board.

Generally, analog and digital lines should cross each other at 90 degrees to avoid getting digital noise into the analog path. In high frequency systems, however, avoid crossing analog and digital lines altogether. Clock lines should be isolated from ALL other lines, analog and digital. Even the generally accepted 90 degree crossing should be avoided as even a little coupling can cause problems at high frequencies. Best performance at high frequencies and at high resolution is obtained with a straight signal path.

Be especially careful with the layout of inductors. Mutual inductance can change the characteristics of the circuit in which they are used. Inductors should not be placed side by side, not even with just a small part of their bodies being beside each other.

The analog input should be isolated from noisy signal traces to avoid coupling of spurious signals into the input. Any external component (e.g., a filter capacitor) connected between the converter's input and ground should be connected to a very clean point in the analog ground return.

## DYNAMIC PERFORMANCE

The ADC1173 is AC tested and its dynamic performance is ensured. To meet the published specifications, the clock source driving the CLK input must be free of jitter. For best a.c. performance, isolating the ADC clock from any digital circuitry should be done with adequate buffers, as with a clock tree. See [Figure 29](#).

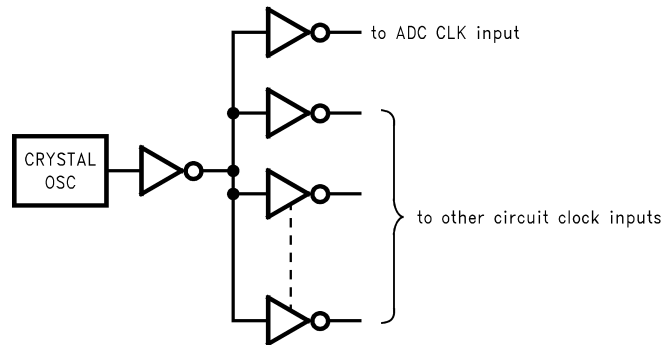

Figure 29. Isolating the ADC Clock From Digital Circuitry

It is good practice to keep the ADC clock line as short as possible and to keep it well away from any other signals. Other signals can introduce jitter into the clock signal.

## COMMON APPLICATION PITFALLS

**Driving the inputs (analog or digital) beyond the power supply rails.** For proper operation, all inputs should not go more than 50mV below the ground pins or 50mV above the supply pins. Exceeding these limits on even a transient basis can cause faulty or erratic operation. It is not uncommon for high speed digital circuits (e.g., 74F and 74AC devices) to exhibit undershoot that goes more than a volt below ground. A resistor of 50Ω in series with the offending digital input will usually eliminate the problem.

Care should be taken not to overdrive the inputs of the ADC1173. Such practice may lead to conversion inaccuracies and even to device damage.

**Attempting to drive a high capacitance digital data bus.** The more capacitance the output drivers must charge for each conversion, the more instantaneous digital current is required from DV<sub>DD</sub> and DGND. These large charging current spikes can couple into the analog section, degrading dynamic performance. Buffering the digital data outputs (with an 74ACQ541, for example) may be necessary if the data bus to be driven is heavily loaded. Dynamic performance can also be improved by adding 47Ω to 100Ω series resistors at each digital output, reducing the energy coupled back into the converter output pins.

**Using an inadequate amplifier to drive the analog input.** As explained in [THE ANALOG INPUT](#), the capacitance seen at the input alternates between 4 pF and 11 pF with the clock. This dynamic capacitance is more difficult to drive than is a fixed capacitance, and should be considered when choosing a driving device. The LMH6702, LM6152, LM6154, LM6181 and LM6182 have been found to be excellent devices for driving the ADC1173 analog input.

**Driving the  $V_{RT}$  pin or the  $V_{RB}$  pin with devices that can not source or sink the current required by the ladder.** As mentioned in [REFERENCE INPUTS](#), care should be taken to see that any driving devices can source sufficient current into the  $V_{RT}$  pin and sink sufficient current from the  $V_{RB}$  pin. If these pins are not driven with devices that can handle the required current, these reference pins will not be stable, resulting in a reduction of dynamic performance.

**Using a clock source with excessive jitter, using an excessively long clock signal trace, or having other signals coupled to the clock signal trace.** This will cause the sampling interval to vary, causing excessive output noise and a reduction in SNR performance. Simple gates with RC timing is generally inadequate as a clock source.

**Input test signal contains harmonic distortion that interferes with the measurement of dynamic signal to noise ratio.** Harmonic and other interfering signals can be removed by inserting a filter at the signal input. Suitable filters are shown in [Figure 30](#) and [Figure 31](#). The circuit of [Figure 30](#) has cutoff of about 5.5 MHz and is suitable for input frequencies of 1 MHz to 5 MHz. The circuit of [Figure 31](#) has a cutoff of about 11 MHz and is suitable for input frequencies of 5 MHz to 10 MHz. These filters should be driven by a generator of 75 Ohm source impedance and terminated with a 75 ohm resistor.

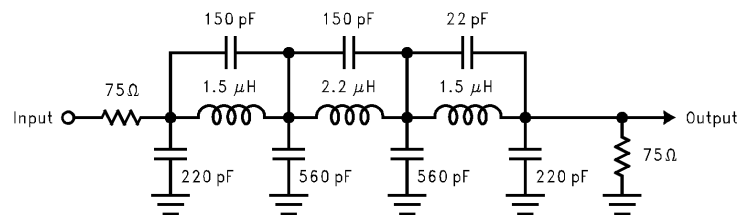

**Figure 30. 5.5 MHz Low Pass Filter to Eliminate Harmonics at the Signal Input**

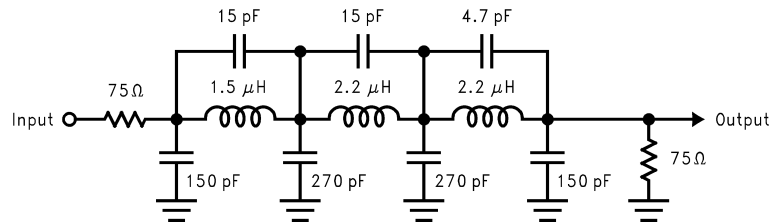

Use at Input Frequencies of 5 MHz to 10 MHz

**Figure 31. 11 MHz Low Pass filter to Eliminate Harmonics at the Signal Input.**



---

**REVISION HISTORY**

<b>Changes from Revision E (April 2013) to Revision F</b>	<b>Page</b>
• Changed layout of National Data Sheet to TI format .....	<a href="#">22</a>

---

**PACKAGING INFORMATION**

Orderable Device	Status (1)	Package Type	Package Drawing	Pins	Package Qty	Eco Plan (2)	Lead finish/ Ball material (6)	MSL Peak Temp (3)	Op Temp (°C)	Device Marking (4/5)	Samples
ADC1173CIMTC/NOPB	ACTIVE	TSSOP	PW	24	61	RoHS & Green	SN	Level-1-260C-UNLIM	-40 to 75	ADC1173 CIMTC	
ADC1173CIMTCX/NOPB	ACTIVE	TSSOP	PW	24	2500	RoHS & Green	SN	Level-1-260C-UNLIM	-40 to 75	ADC1173 CIMTC	

(1) The marketing status values are defined as follows:

**ACTIVE:** Product device recommended for new designs.

**LIFEBUY:** TI has announced that the device will be discontinued, and a lifetime-buy period is in effect.

**NRND:** Not recommended for new designs. Device is in production to support existing customers, but TI does not recommend using this part in a new design.

**PREVIEW:** Device has been announced but is not in production. Samples may or may not be available.

**OBSOLETE:** TI has discontinued the production of the device.

(2) **RoHS:** TI defines "RoHS" to mean semiconductor products that are compliant with the current EU RoHS requirements for all 10 RoHS substances, including the requirement that RoHS substance do not exceed 0.1% by weight in homogeneous materials. Where designed to be soldered at high temperatures, "RoHS" products are suitable for use in specified lead-free processes. TI may reference these types of products as "Pb-Free".

**RoHS Exempt:** TI defines "RoHS Exempt" to mean products that contain lead but are compliant with EU RoHS pursuant to a specific EU RoHS exemption.

**Green:** TI defines "Green" to mean the content of Chlorine (Cl) and Bromine (Br) based flame retardants meet JS709B low halogen requirements of <=1000ppm threshold. Antimony trioxide based flame retardants must also meet the <=1000ppm threshold requirement.

(3) MSL, Peak Temp. - The Moisture Sensitivity Level rating according to the JEDEC industry standard classifications, and peak solder temperature.

(4) There may be additional marking, which relates to the logo, the lot trace code information, or the environmental category on the device.

(5) Multiple Device Markings will be inside parentheses. Only one Device Marking contained in parentheses and separated by a "~" will appear on a device. If a line is indented then it is a continuation of the previous line and the two combined represent the entire Device Marking for that device.

(6) Lead finish/Ball material - Orderable Devices may have multiple material finish options. Finish options are separated by a vertical ruled line. Lead finish/Ball material values may wrap to two lines if the finish value exceeds the maximum column width.

**Important Information and Disclaimer:**The information provided on this page represents TI's knowledge and belief as of the date that it is provided. TI bases its knowledge and belief on information provided by third parties, and makes no representation or warranty as to the accuracy of such information. Efforts are underway to better integrate information from third parties. TI has taken and continues to take reasonable steps to provide representative and accurate information but may not have conducted destructive testing or chemical analysis on incoming materials and chemicals. TI and TI suppliers consider certain information to be proprietary, and thus CAS numbers and other limited information may not be available for release.

In no event shall TI's liability arising out of such information exceed the total purchase price of the TI part(s) at issue in this document sold by TI to Customer on an annual basis.





**TAPE AND REEL INFORMATION**

**QUADRANT ASSIGNMENTS FOR PIN 1 ORIENTATION IN TAPE**



\*All dimensions are nominal

Device	Package Type	Package Drawing	Pins	SPQ	Reel Diameter (mm)	Reel Width W1 (mm)	A0 (mm)	B0 (mm)	K0 (mm)	P1 (mm)	W (mm)	Pin1 Quadrant
ADC1173CIMTCX/NOPB	TSSOP	PW	24	2500	330.0	16.4	6.95	8.3	1.6	8.0	16.0	Q1

**TAPE AND REEL BOX DIMENSIONS**

\*All dimensions are nominal

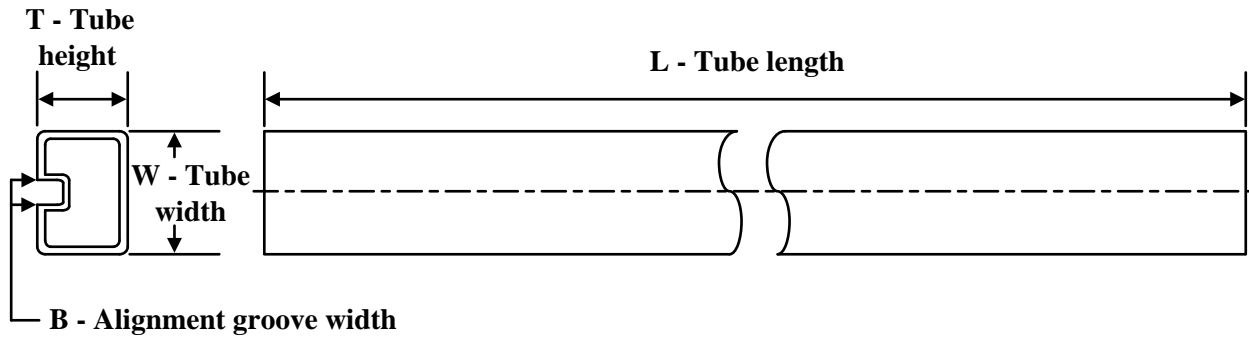
Device	Package Type	Package Drawing	Pins	SPQ	Length (mm)	Width (mm)	Height (mm)
ADC1173CIMTCX/NOPB	TSSOP	PW	24	2500	367.0	367.0	35.0

**TUBE**

\*All dimensions are nominal

Device	Package Name	Package Type	Pins	SPQ	L (mm)	W (mm)	T (μm)	B (mm)
ADC1173CIMTC/NOPB	PW	TSSOP	24	61	495	8	2514.6	4.06

PW0024A



**PACKAGE OUTLINE**  
**TSSOP - 1.2 mm max height**

SMALL OUTLINE PACKAGE



NOTES:

1. All linear dimensions are in millimeters. Any dimensions in parenthesis are for reference only. Dimensioning and tolerancing per ASME Y14.5M.
2. This drawing is subject to change without notice.
3. This dimension does not include mold flash, protrusions, or gate burrs. Mold flash, protrusions, or gate burrs shall not exceed 0.15 mm per side.
4. This dimension does not include interlead flash. Interlead flash shall not exceed 0.25 mm per side.
5. Reference JEDEC registration MO-153.

# EXAMPLE BOARD LAYOUT

PW0024A

TSSOP - 1.2 mm max height

SMALL OUTLINE PACKAGE

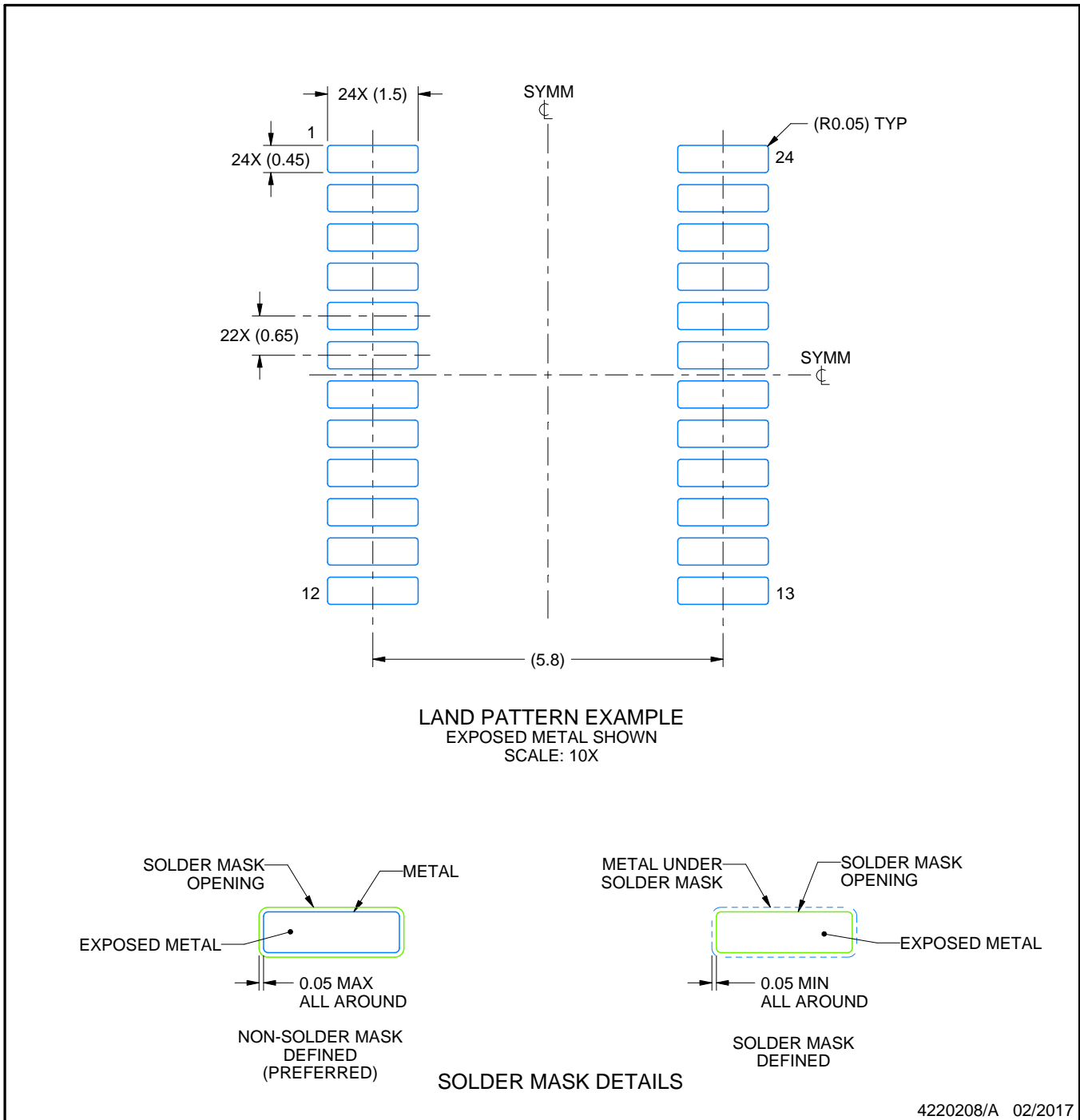

NOTES: (continued)

- 6. Publication IPC-7351 may have alternate designs.
- 7. Solder mask tolerances between and around signal pads can vary based on board fabrication site.

# EXAMPLE STENCIL DESIGN

PW0024A

TSSOP - 1.2 mm max height

SMALL OUTLINE PACKAGE

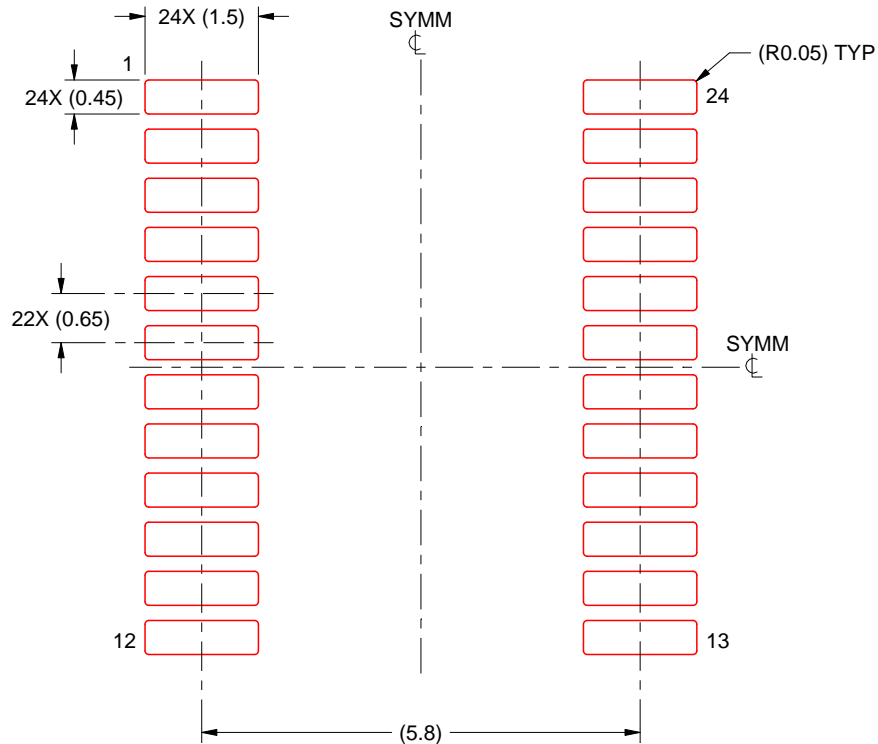

SOLDER PASTE EXAMPLE  
BASED ON 0.125 mm THICK STENCIL  
SCALE: 10X

4220208/A 02/2017

NOTES: (continued)

8. Laser cutting apertures with trapezoidal walls and rounded corners may offer better paste release. IPC-7525 may have alternate design recommendations.
9. Board assembly site may have different recommendations for stencil design.

## IMPORTANT NOTICE AND DISCLAIMER

TI PROVIDES TECHNICAL AND RELIABILITY DATA (INCLUDING DATA SHEETS), DESIGN RESOURCES (INCLUDING REFERENCE DESIGNS), APPLICATION OR OTHER DESIGN ADVICE, WEB TOOLS, SAFETY INFORMATION, AND OTHER RESOURCES "AS IS" AND WITH ALL FAULTS, AND DISCLAIMS ALL WARRANTIES, EXPRESS AND IMPLIED, INCLUDING WITHOUT LIMITATION ANY IMPLIED WARRANTIES OF MERCHANTABILITY, FITNESS FOR A PARTICULAR PURPOSE OR NON-INFRINGEMENT OF THIRD PARTY INTELLECTUAL PROPERTY RIGHTS.

These resources are intended for skilled developers designing with TI products. You are solely responsible for (1) selecting the appropriate TI products for your application, (2) designing, validating and testing your application, and (3) ensuring your application meets applicable standards, and any other safety, security, regulatory or other requirements.

These resources are subject to change without notice. TI grants you permission to use these resources only for development of an application that uses the TI products described in the resource. Other reproduction and display of these resources is prohibited. No license is granted to any other TI intellectual property right or to any third party intellectual property right. TI disclaims responsibility for, and you will fully indemnify TI and its representatives against, any claims, damages, costs, losses, and liabilities arising out of your use of these resources.

TI's products are provided subject to [TI's Terms of Sale](#) or other applicable terms available either on [ti.com](https://www.ti.com) or provided in conjunction with such TI products. TI's provision of these resources does not expand or otherwise alter TI's applicable warranties or warranty disclaimers for TI products.

TI objects to and rejects any additional or different terms you may have proposed.

Mailing Address: Texas Instruments, Post Office Box 655303, Dallas, Texas 75265  
Copyright © 2024, Texas Instruments Incorporated