

ADC12C105 12-Bit, 95/105 MSPS A/D Converter

Check for Samples: [ADC12C105](#)

FEATURES

- 1 GHz Full Power Bandwidth
- Internal Reference and Sample-and-Hold Circuit
- Low Power Consumption
- Data Ready Output Clock
- Clock Duty Cycle Stabilizer
- Single +3.0V or +3.3V Supply Operation
- Power-Down Mode
- 32-Pin WQFN Package, (5x5x0.8mm, 0.5mm Pin-Pitch)

APPLICATIONS

- High IF Sampling Receivers
- Wireless Base Station Receivers
- Test and Measurement Equipment
- Communications Instrumentation
- Portable Instrumentation

KEY SPECIFICATIONS

- Resolution: 12 Bits
- Conversion Rate: 105 MSPS
- SNR: ($f_{IN} = 240$ MHz) 69 dBFS (typ)
- SFDR: ($f_{IN} = 240$ MHz) 82 dBFS (typ)
- Full Power Bandwidth: 1 GHz (typ)
- Power Consumption:
 - 350 mW (typ), $V_A=3.0$ V
 - 400 mW (typ), $V_A=3.3$ V

DESCRIPTION

The ADC12C105 is a high-performance CMOS analog-to-digital converter capable of converting analog input signals into 12-bit digital words at rates up to 105 Mega Samples Per Second (MSPS). This converter uses a differential, pipelined architecture with digital error correction and an on-chip sample-and-hold circuit to minimize power consumption and the external component count, while providing excellent dynamic performance. A unique sample-and-hold stage yields a full-power bandwidth of 1 GHz. The ADC12C105 may be operated from a single +3.0V or +3.3V power supply and consumes low power.

A separate +2.5V supply may be used for the digital output interface which allows lower power operation with reduced noise. A power-down feature reduces the power consumption to very low levels while still allowing fast wake-up time to full operation. The differential inputs accept a 2V full scale differential input swing. A stable 1.2V internal voltage reference is provided, or the ADC12C105 can be operated with an external 1.2V reference. Output data format (offset binary versus 2's complement) and duty cycle stabilizer are pin-selectable. The duty cycle stabilizer maintains performance over a wide range of clock duty cycles.

The ADC12C105 is available in a 32-lead WQFN package and operates over the industrial temperature range of -40°C to $+85^{\circ}\text{C}$.



Please be aware that an important notice concerning availability, standard warranty, and use in critical applications of Texas Instruments semiconductor products and disclaimers thereto appears at the end of this data sheet.

All trademarks are the property of their respective owners.

Connection Diagram

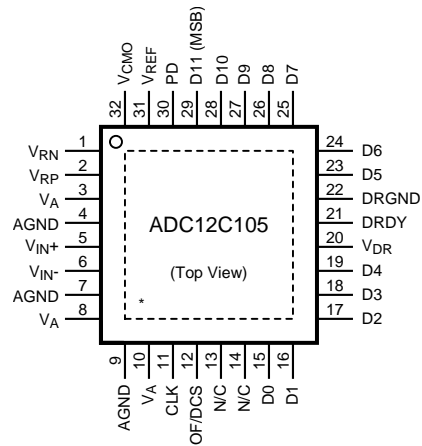

Block Diagram

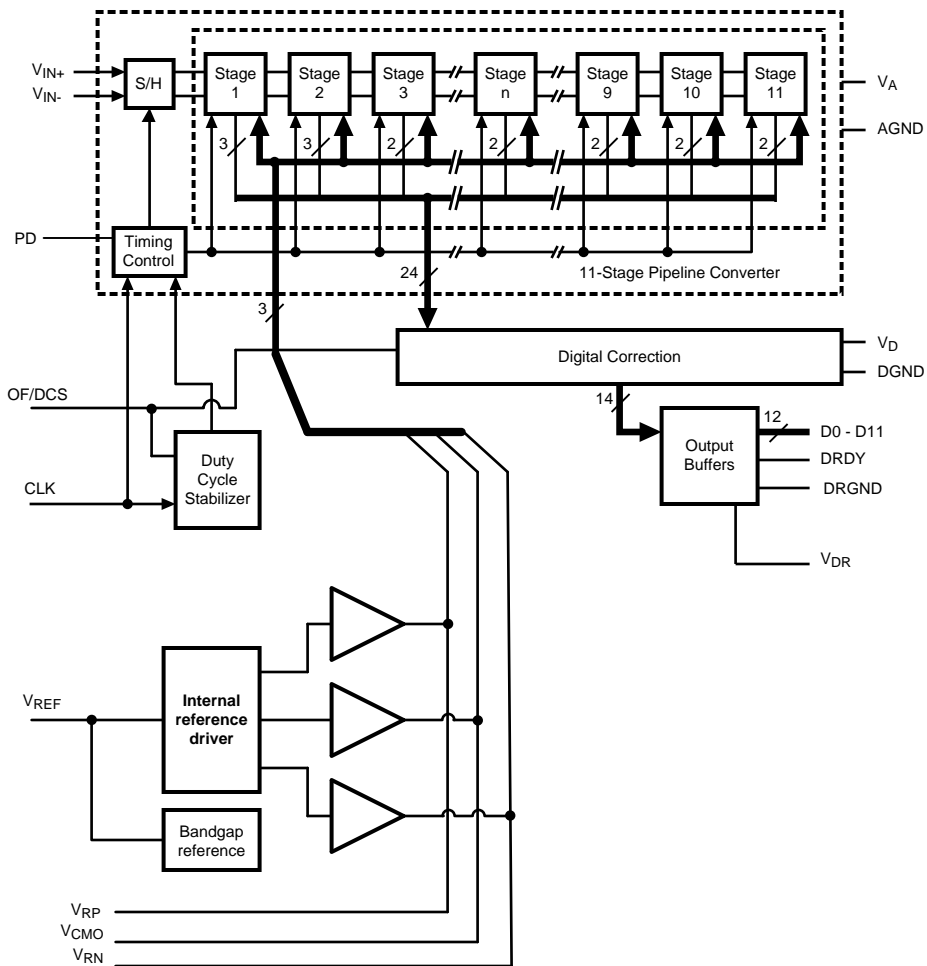

Pin Descriptions and Equivalent Circuits

Pin No.	Symbol	Equivalent Circuit	Description
ANALOG I/O			
5	V_{IN+}		Differential analog input pins. The differential full-scale input signal level is $2V_{P-P}$ with each input pin signal centered on a common mode voltage, V_{CM} .
6	V_{IN-}		
2	V_{RP}		These pins should each be bypassed to AGND with a low ESL (equivalent series inductance) 0.1 μF capacitor placed very close to the pin to minimize stray inductance. A 0.1 μF capacitor should be placed between V_{RP} and V_{RN} as close to the pins as possible, and a 1 μF capacitor should be placed in parallel. V_{RP} and V_{RN} should not be loaded. V_{CMO} may be loaded to 1mA for use as a temperature stable 1.5V reference. It is recommended to use V_{CMO} to provide the common mode voltage, V_{CM} , for the differential analog inputs, V_{IN+} and V_{IN-} .
32	V_{CMO}		
1	V_{RN}		
31	V_{REF}		Reference Voltage. This device provides an internally developed 1.2V reference. When using the internal reference, V_{REF} should be decoupled to AGND with a 0.1 μF and a 1 μF low equivalent series inductance (ESL) capacitor . This pin may be driven with an external 1.2V reference voltage. This pin should not be used to source or sink current.
12	OF/DCS		This is a four-state pin controlling the input clock mode and output data format. OF/DCS = V_A , output data format is 2's complement without duty cycle stabilization applied to the input clock OF/DCS = AGND, output data format is offset binary, without duty cycle stabilization applied to the input clock. OF/DCS = $(2/3)V_A$, output data is 2's complement with duty cycle stabilization applied to the input clock OF/DCS = $(1/3)V_A$, output data is offset binary with duty cycle stabilization applied to the input clock.

Pin Descriptions and Equivalent Circuits (continued)

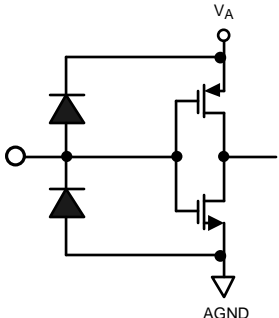
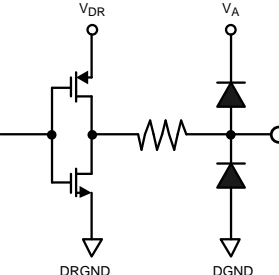
Pin No.	Symbol	Equivalent Circuit	Description
DIGITAL I/O			
11	CLK		The clock input pin. The analog input is sampled on the rising edge of the clock input.
30	PD		This is a two-state input controlling Power Down. PD = V_A , Power Down is enabled and power dissipation is reduced. PD = AGND, Normal operation.
15-19, 23-29	D0–D11		Digital data output pins that make up the 12-bit conversion result. D0 (pin 15) is the LSB, while D11 (pin 29) is the MSB of the output word. Output levels are CMOS compatible.
21	DRDY		Data Ready Strobe. The data output transition is synchronized with the falling edge of this signal. This signal switches at the same frequency as the CLK input.
13, 14	NC		No internal connection
ANALOG POWER			
3, 8, 10	V_A		Positive analog supply pins. These pins should be connected to a quiet voltage source and be bypassed to AGND with 0.1 μ F capacitors located close to the power pins.
4, 7, 9, Exposed Pad	AGND		The ground return for the analog supply. The exposed pad on back of package must be soldered to ground plane to ensure rated performance.
DIGITAL POWER			
20	V_{DR}		Positive driver supply pin for the output drivers. This pin should be connected to a quiet voltage source and be bypassed to DRGND with a 0.1 μ F capacitor located close to the power pin.
22	DRGND		The ground return for the digital output driver supply. This pins should be connected to the system digital ground, but not be connected in close proximity to the ADC's AGND pins.



These devices have limited built-in ESD protection. The leads should be shorted together or the device placed in conductive foam during storage or handling to prevent electrostatic damage to the MOS gates.

Absolute Maximum Ratings⁽¹⁾⁽²⁾⁽³⁾

Supply Voltage (V_A , V_{DR})		-0.3V to 4.2V
Voltage on Any Pin (Not to exceed 4.2V)		-0.3V to ($V_A + 0.3V$)
Input Current at Any Pin other than Supply Pins ⁽⁴⁾		± 5 mA
Package Input Current ⁽⁴⁾		± 50 mA
Max Junction Temp (T_J)		+150°C
Thermal Resistance (θ_{JA}) ⁽⁵⁾		30°C/W
ESD Rating	Human Body Model ⁽⁶⁾	2500V
	Machine Model ⁽⁶⁾	250V
Storage Temperature		-65°C to +150°C
Soldering process must comply with TI's Reflow Temperature Profile specifications. Refer to www.ti.com/packaging . ⁽⁷⁾		

- (1) All voltages are measured with respect to GND = AGND = DRGND = 0V, unless otherwise specified.
- (2) Absolute Maximum Ratings indicate limits beyond which damage to the device may occur. Operating Ratings indicate conditions for which the device is specified to be functional, but do not ensure specific performance limits. For ensured specifications and test conditions, see the Electrical Characteristics. The ensured specifications apply only for the test conditions listed. Some performance characteristics may degrade when the device is not operated under the listed test conditions. Operation of the device beyond the maximum Operating Ratings is not recommended.
- (3) If Military/Aerospace specified devices are required, please contact the TI Sales Office/ Distributors for availability and specifications.
- (4) When the input voltage at any pin exceeds the power supplies (that is, $V_{IN} < AGND$, or $V_{IN} > V_A$), the current at that pin should be limited to ± 5 mA. The ± 50 mA maximum package input current rating limits the number of pins that can safely exceed the power supplies with an input current of ± 5 mA to 10.
- (5) The maximum allowable power dissipation is dictated by $T_{J,max}$, the junction-to-ambient thermal resistance, (θ_{JA}), and the ambient temperature, (T_A), and can be calculated using the formula $P_{D,max} = (T_{J,max} - T_A) / \theta_{JA}$. The values for maximum power dissipation listed above will be reached only when the device is operated in a severe fault condition (e.g. when input or output pins are driven beyond the power supply voltages, or the power supply polarity is reversed). Such conditions should always be avoided.
- (6) Human Body Model is 100 pF discharged through a 1.5 k Ω resistor. Machine Model is 220 pF discharged through 0 Ω .
- (7) Reflow temperature profiles are different for lead-free and non-lead-free packages.

Operating Ratings⁽¹⁾⁽²⁾

Operating Temperature		$-40^\circ\text{C} \leq T_A \leq +85^\circ\text{C}$
Supply Voltage (V_A)		+2.7V to +3.6V
Output Driver Supply (V_{DR})		+2.4V to V_A
Clock Duty Cycle	(DCS Enabled)	30/70 %
	(DCS disabled)	45/55 %
V_{CM}		1.4V to 1.6V
AGND-DRGND		≤ 100 mV

- (1) Absolute Maximum Ratings indicate limits beyond which damage to the device may occur. Operating Ratings indicate conditions for which the device is specified to be functional, but do not ensure specific performance limits. For ensured specifications and test conditions, see the Electrical Characteristics. The ensured specifications apply only for the test conditions listed. Some performance characteristics may degrade when the device is not operated under the listed test conditions. Operation of the device beyond the maximum Operating Ratings is not recommended.
- (2) All voltages are measured with respect to GND = AGND = DRGND = 0V, unless otherwise specified.

Converter Electrical Characteristics

Unless otherwise specified, the following specifications apply: AGND = DRGND = 0V, $V_A = +3.3V$, $V_{DR} = +2.5V$, Internal $V_{REF} = +1.2V$, $f_{CLK} = 105\text{ MHz}$, 50% Duty Cycle, DCS disabled, $V_{CM} = V_{CMO}$, $C_L = 5\text{ pF/pin}$. Typical values are for $T_A = 25^\circ\text{C}$.

Boldface limits apply for $T_{MIN} \leq T_A \leq T_{MAX}$. All other limits apply for $T_A = 25^\circ\text{C}$ ⁽¹⁾ ⁽²⁾

Symbol	Parameter	Conditions	Typical ⁽³⁾	Limits	Units (Limits)
STATIC CONVERTER CHARACTERISTICS					
	Resolution with No Missing Codes			12	Bits (min)
INL	Integral Non Linearity		± 0.5	1.2	LSB (max)
				-1.2	LSB (min)
DNL	Differential Non Linearity		± 0.35	0.7	LSB (max)
				-0.6	LSB (min)
PGE	Positive Gain Error		-0.35	± 1.25	%FS (max)
NGE	Negative Gain Error		-0.2	± 1.25	%FS (max)
TC PGE	Positive Gain Error Tempco	$-40^\circ\text{C} \leq T_A \leq +85^\circ\text{C}$	-3		ppm/ $^\circ\text{C}$
TC NGE	Negative Gain Error Tempco	$-40^\circ\text{C} \leq T_A \leq +85^\circ\text{C}$	-7		ppm/ $^\circ\text{C}$
V_{OFF}	Offset Error ($V_{IN+} = V_{IN-}$)		0.065	± 0.55	%FS (max)
TC V_{OFF}	Offset Error Tempco	$-40^\circ\text{C} \leq T_A \leq +85^\circ\text{C}$	-4		ppm/ $^\circ\text{C}$
	Under Range Output Code		0	0	
	Over Range Output Code		4095	4095	
REFERENCE AND ANALOG INPUT CHARACTERISTICS					
V_{CMO}	Common Mode Output Voltage		1.5	1.4 1.56	V (min) V (max)
V_{CM}	Analog Input Common Mode Voltage		1.5	1.4 1.6	V (min) V (max)
C_{IN}	V_{IN} Input Capacitance (each pin to GND) ⁽⁴⁾	$V_{IN} = 1.5\text{ Vdc} \pm 0.5\text{ V}$	(CLK LOW)	8.5	pF
			(CLK HIGH)	3.5	pF
V_{REF}	Internal Reference Voltage		1.18		V
TC V_{REF}	Internal Reference Voltage Tempco	$-40^\circ\text{C} \leq T_A \leq +85^\circ\text{C}$	18		ppm/ $^\circ\text{C}$
V_{RP}	Internal Reference top		1.98	1.89 2.06	V (min) V (max)
V_{RN}	Internal Reference bottom		0.98	0.89 1.06	V (min) V (max)
Ext V_{REF}	External Reference Voltage		1.20	1.176 1.224	V (min) V (max)

- (1) The inputs are protected as shown below. Input voltage magnitudes above V_A or below GND will not damage this device, provided current is limited per [Absolute Maximum Ratings, Note 4](#). However, errors in the A/D conversion can occur if the input goes above 2.6V or below GND as described in the [Operating Ratings](#) section.

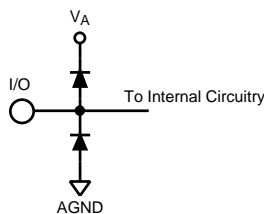

- (2) With a full scale differential input of $2V_{P-P}$, the 12-bit LSB is $488\ \mu\text{V}$.
 (3) Typical figures are at $T_A = 25^\circ\text{C}$ and represent most likely parametric norms at the time of product characterization. The typical specifications are not ensured.
 (4) The input capacitance is the sum of the package/pin capacitance and the sample and hold circuit capacitance.

Dynamic Converter Electrical Characteristics

Unless otherwise specified, the following specifications apply: AGND = DRGND = 0V, $V_A = +3.3V$, $V_{DR} = +2.5V$, Internal $V_{REF} = +1.2V$, $f_{CLK} = 105\text{ MHz}$, 50% Duty Cycle, DCS disabled, $V_{CM} = V_{CMO}$, $C_L = 5\text{ pF/pin}$, . Typical values are for $T_A = 25^\circ\text{C}$.

Boldface limits apply for $T_{MIN} \leq T_A \leq T_{MAX}$. All other limits apply for $T_A = 25^\circ\text{C}$ ⁽¹⁾ ⁽²⁾

Symbol	Parameter	Conditions	Typical ⁽³⁾	Limits	Units (Limits) ⁽⁴⁾
DYNAMIC CONVERTER CHARACTERISTICS, $A_{IN} = -1\text{dBFS}$					
FPBW	Full Power Bandwidth	-1 dBFS Input, -3 dB Corner	1.0		GHz
SNR	Signal-to-Noise Ratio	$f_{IN} = 10\text{ MHz}$	71		dBFS
		$f_{IN} = 70\text{ MHz}$	70.5		dBFS
		$f_{IN} = 240\text{ MHz}$	69	68.3	dBFS
SFDR	Spurious Free Dynamic Range	$f_{IN} = 10\text{ MHz}$	90		dBFS
		$f_{IN} = 70\text{ MHz}$	86		dBFS
		$f_{IN} = 240\text{ MHz}$	82	78	dBFS
ENOB	Effective Number of Bits	$f_{IN} = 10\text{ MHz}$	11.5		Bits
		$f_{IN} = 70\text{ MHz}$	11.3		Bits
		$f_{IN} = 240\text{ MHz}$	11.1	10.9	Bits
THD	Total Harmonic Distortion	$f_{IN} = 10\text{ MHz}$	-86		dBFS
		$f_{IN} = 70\text{ MHz}$	-85		dBFS
		$f_{IN} = 240\text{ MHz}$	-80	-74	dBFS
H2	Second Harmonic Distortion	$f_{IN} = 10\text{ MHz}$	-95		dBFS
		$f_{IN} = 70\text{ MHz}$	-90		dBFS
		$f_{IN} = 240\text{ MHz}$	-86	-78	dBFS
H3	Third Harmonic Distortion	$f_{IN} = 10\text{ MHz}$	-90		dBFS
		$f_{IN} = 70\text{ MHz}$	-86		dBFS
		$f_{IN} = 240\text{ MHz}$	-82	-78	dBFS
SINAD	Signal-to-Noise and Distortion Ratio	$f_{IN} = 10\text{ MHz}$	70.8		dBFS
		$f_{IN} = 70\text{ MHz}$	70		dBFS
		$f_{IN} = 240\text{ MHz}$	68.6	67.4	dBFS
IMD	Intermodulation Distortion	$f_{IN} = 19.5\text{ MHz}$ and 20.5 MHz , each -7 dBFS	-82		dBFS

- (1) The inputs are protected as shown below. Input voltage magnitudes above V_A or below GND will not damage this device, provided current is limited per [Absolute Maximum Ratings, Note 4](#). However, errors in the A/D conversion can occur if the input goes above 2.6V or below GND as described in the [Operating Ratings](#) section.

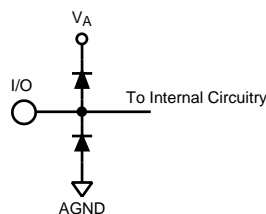

- (2) With a full scale differential input of $2V_{P-P}$, the 12-bit LSB is $488\text{ }\mu\text{V}$.
- (3) Typical figures are at $T_A = 25^\circ\text{C}$ and represent most likely parametric norms at the time of product characterization. The typical specifications are not ensured.
- (4) Parameters specified in dBFS indicate the value that would be attained with a full-scale input signal.

Logic and Power Supply Electrical Characteristics

Unless otherwise specified, the following specifications apply: AGND = DRGND = 0V, $V_A = +3.3V$, $V_{DR} = +2.5V$, Internal $V_{REF} = +1.2V$, $f_{CLK} = 105\text{ MHz}$, 50% Duty Cycle, DCS disabled, $V_{CM} = V_{CMO}$, $C_L = 5\text{ pF/pin}$. Typical values are for $T_A = 25^\circ\text{C}$.

Boldface limits apply for $T_{MIN} \leq T_A \leq T_{MAX}$. All other limits apply for $T_A = 25^\circ\text{C}$ ⁽¹⁾ ⁽²⁾

Symbol	Parameter	Conditions	Typical ⁽³⁾	Limits	Units (Limits)
DIGITAL INPUT CHARACTERISTICS (CLK, PD)					
$V_{IN(1)}$	Logical "1" Input Voltage	$V_D = 3.6V$		2.0	V (min)
$V_{IN(0)}$	Logical "0" Input Voltage	$V_D = 3.0V$		0.8	V (max)
$I_{IN(1)}$	Logical "1" Input Current	$V_{IN} = 3.3V$	10		μA
$I_{IN(0)}$	Logical "0" Input Current	$V_{IN} = 0V$	-10		μA
C_{IN}	Digital Input Capacitance		5		pF
DIGITAL OUTPUT CHARACTERISTICS (D0–D13, DRDY)					
$V_{OUT(1)}$	Logical "1" Output Voltage	$I_{OUT} = -0.5\text{ mA}$, $V_{DR} = 2.4V$		2.0	V (min)
$V_{OUT(0)}$	Logical "0" Output Voltage	$I_{OUT} = 1.6\text{ mA}$, $V_{DR} = 2.4V$		0.4	V (max)
+ I_{SC}	Output Short Circuit Source Current	$V_{OUT} = 0V$	-10		mA
- I_{SC}	Output Short Circuit Sink Current	$V_{OUT} = V_{DR}$	10		mA
C_{OUT}	Digital Output Capacitance		5		pF
POWER SUPPLY CHARACTERISTICS					
I_A	Analog Supply Current	Full Operation	121	141	mA (max)
I_{DR}	Digital Output Supply Current	Full Operation ⁽⁴⁾	16		mA
	Power Consumption	Excludes I_{DR} ⁽⁴⁾	400	466	mW (max)
	Power Down Power Consumption	Clock disabled	7.5		mW

- (1) The inputs are protected as shown below. Input voltage magnitudes above V_A or below GND will not damage this device, provided current is limited per [Absolute Maximum Ratings, Note 4](#). However, errors in the A/D conversion can occur if the input goes above 2.6V or below GND as described in the [Operating Ratings](#) section.

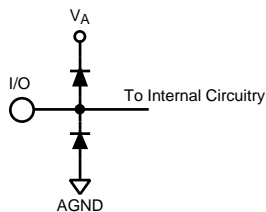

- (2) With a full scale differential input of $2V_{P-P}$, the 12-bit LSB is $488\ \mu\text{V}$.
- (3) Typical figures are at $T_A = 25^\circ\text{C}$ and represent most likely parametric norms at the time of product characterization. The typical specifications are not ensured.
- (4) I_{DR} is the current consumed by the switching of the output drivers and is primarily determined by load capacitance on the output pins, the supply voltage, V_{DR} , and the rate at which the outputs are switching (which is signal dependent). $I_{DR} = V_{DR}(C_0 \times f_0 + C_1 \times f_1 + \dots + C_{11} \times f_{11})$ where V_{DR} is the output driver power supply voltage, C_n is total capacitance on the output pin, and f_n is the average frequency at which that pin is toggling.

Timing and AC Characteristics

Unless otherwise specified, the following specifications apply: AGND = DRGND = 0V, $V_A = +3.3V$, $V_{DR} = +2.5V$, Internal $V_{REF} = +1.2V$, $f_{CLK} = 105$ MHz, 50% Duty Cycle, DCS disabled, $V_{CM} = V_{CMO}$, $C_L = 5$ pF/pin. Typical values are for $T_A = 25^\circ C$. Timing measurements are taken at 50% of the signal amplitude. **Boldface limits apply for $T_{MIN} \leq T_A \leq T_{MAX}$.** All other limits apply for $T_A = 25^\circ C$ ⁽¹⁾ ⁽²⁾

Symbol	Parameter	Conditions	Typical ⁽³⁾	Limits	Units (Limits)
	Maximum Clock Frequency			105	MHz (max)
	Minimum Clock Frequency			20	MHz (min)
t_{CH}	Clock High Time		4		ns
t_{CL}	Clock Low Time		4		ns
t_{CONV}	Conversion Latency			7	Clock Cycles
t_{OD}	Output Delay of CLK to DATA	Relative to rising edge of CLK ⁽⁴⁾	5.76	3 7.3	ns (min) ns (max)
t_{SU}	Data Output Setup Time	Relative to DRDY	4.5	3.7	ns (min)
t_H	Data Output Hold Time	Relative to DRDY	4.5	3.8	ns (min)
t_{AD}	Aperture Delay		0.6		ns
t_{AJ}	Aperture Jitter		0.1		ps rms

- (1) The inputs are protected as shown below. Input voltage magnitudes above V_A or below GND will not damage this device, provided current is limited per [Absolute Maximum Ratings, Note 4](#). However, errors in the A/D conversion can occur if the input goes above 2.6V or below GND as described in the [Operating Ratings](#) section.

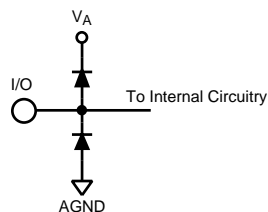

- (2) With a full scale differential input of $2V_{P-P}$, the 12-bit LSB is $488 \mu V$.
 (3) Typical figures are at $T_A = 25^\circ C$ and represent most likely parametric norms at the time of product characterization. The typical specifications are not ensured.
 (4) This parameter is specified by design and/or characterization and is not tested in production.

Dynamic Converter Electrical Characteristics at 95MSPS

Unless otherwise specified, the following specifications apply: AGND = DRGND = 0V, $V_A = +3.3V$, $V_{DR} = +2.5V$, Internal $V_{REF} = +1.2V$, $f_{CLK} = 95\text{ MHz}$, 50% Duty Cycle, DCS disabled, $V_{CM} = V_{CMO}$, $C_L = 5\text{ pF/pin}$, . Typical values are for $T_A = 25^\circ\text{C}$.

Boldface limits apply for $T_{MIN} \leq T_A \leq T_{MAX}$. All other limits apply for $T_A = 25^\circ\text{C}$ ^{(1) (2)}

Symbol	Parameter	Conditions	Typical ⁽³⁾	Limits	Units (Limits) ⁽⁴⁾
DYNAMIC CONVERTER CHARACTERISTICS, $A_{IN} = -1\text{dBFS}$					
SNR	Signal-to-Noise Ratio	$f_{IN} = 10\text{ MHz}$	71		dBFS
		$f_{IN} = 70\text{ MHz}$	70.5		dBFS
		$f_{IN} = 240\text{ MHz}$	69		dBFS
SFDR	Spurious Free Dynamic Range	$f_{IN} = 10\text{ MHz}$	90		dBFS
		$f_{IN} = 70\text{ MHz}$	86		dBFS
		$f_{IN} = 240\text{ MHz}$	82		dBFS
ENOB	Effective Number of Bits	$f_{IN} = 10\text{ MHz}$	11.5		Bits
		$f_{IN} = 70\text{ MHz}$	11.4		Bits
		$f_{IN} = 240\text{ MHz}$	11.1		Bits
THD	Total Harmonic Distortion	$f_{IN} = 10\text{ MHz}$	-88		dBFS
		$f_{IN} = 70\text{ MHz}$	-85		dBFS
		$f_{IN} = 240\text{ MHz}$	-80		dBFS
H2	Second Harmonic Distortion	$f_{IN} = 10\text{ MHz}$	-95		dBFS
		$f_{IN} = 70\text{ MHz}$	-90		dBFS
		$f_{IN} = 240\text{ MHz}$	-85		dBFS
H3	Third Harmonic Distortion	$f_{IN} = 10\text{ MHz}$	-90		dBFS
		$f_{IN} = 70\text{ MHz}$	-86		dBFS
		$f_{IN} = 240\text{ MHz}$	-82		dBFS
SINAD	Signal-to-Noise and Distortion Ratio	$f_{IN} = 10\text{ MHz}$	70.9		dBFS
		$f_{IN} = 70\text{ MHz}$	70.35		dBFS
		$f_{IN} = 240\text{ MHz}$	68.7		dBFS
POWER SUPPLY CHARACTERISTICS					
I_A	Analog Supply Current	Full Operation	115		mA (max)
I_{DR}	Digital Output Supply Current	Full Operation ⁽⁵⁾	14.5		mA
	Power Consumption	Excludes I_{DR} ⁽⁵⁾	380		mW (max)

(1) The inputs are protected as shown below. Input voltage magnitudes above V_A or below GND will not damage this device, provided current is limited per [Absolute Maximum Ratings, Note 4](#). However, errors in the A/D conversion can occur if the input goes above 2.6V or below GND as described in the [Operating Ratings](#) section.

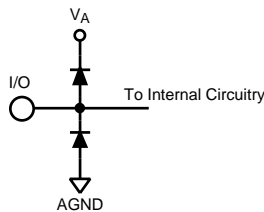

- (2) With a full scale differential input of $2V_{P,P}$, the 12-bit LSB is $488\text{ }\mu\text{V}$.
- (3) Typical figures are at $T_A = 25^\circ\text{C}$ and represent most likely parametric norms at the time of product characterization. The typical specifications are not ensured.
- (4) Parameters specified in dBFS indicate the value that would be attained with a full-scale input signal.
- (5) I_{DR} is the current consumed by the switching of the output drivers and is primarily determined by load capacitance on the output pins, the supply voltage, V_{DR} , and the rate at which the outputs are switching (which is signal dependent). $I_{DR} = V_{DR}(C_0 \times f_0 + C_1 \times f_1 + \dots + C_{11} \times f_{11})$ where V_{DR} is the output driver power supply voltage, C_n is total capacitance on the output pin, and f_n is the average frequency at which that pin is toggling.

Specification Definitions

APERTURE DELAY is the time after the falling edge of the clock to when the input signal is acquired or held for conversion.

APERTURE JITTER (APERTURE UNCERTAINTY) is the variation in aperture delay from sample to sample. Aperture jitter manifests itself as noise in the output.

CLOCK DUTY CYCLE is the ratio of the time during one cycle that a repetitive digital waveform is high to the total time of one period. The specification here refers to the ADC clock input signal.

COMMON MODE VOLTAGE (V_{CM}) is the common DC voltage applied to both input terminals of the ADC.

CONVERSION LATENCY is the number of clock cycles between initiation of conversion and when that data is presented to the output driver stage. Data for any given sample is available at the output pins the Pipeline Delay plus the Output Delay after the sample is taken. New data is available at every clock cycle, but the data lags the conversion by the pipeline delay.

DIFFERENTIAL NON-LINEARITY (DNL) is the measure of the maximum deviation from the ideal step size of 1 LSB.

EFFECTIVE NUMBER OF BITS (ENOB, or EFFECTIVE BITS) is another method of specifying Signal-to-Noise and Distortion Ratio or SINAD. ENOB is defined as $(\text{SINAD} - 1.76) / 6.02$ and says that the converter is equivalent to a perfect ADC of this (ENOB) number of bits.

FULL POWER BANDWIDTH is a measure of the frequency at which the reconstructed output fundamental drops 3 dB below its low frequency value for a full scale input.

GAIN ERROR is the deviation from the ideal slope of the transfer function. It can be calculated as:

$$\text{Gain Error} = \text{Positive Full Scale Error} - \text{Negative Full Scale Error} \quad (1)$$

It can also be expressed as Positive Gain Error and Negative Gain Error, which are calculated as:

$$\text{PGE} = \text{Positive Full Scale Error} - \text{Offset Error} \quad \text{NGE} = \text{Offset Error} - \text{Negative Full Scale Error} \quad (2)$$

INTEGRAL NON LINEARITY (INL) is a measure of the deviation of each individual code from a best fit straight line. The deviation of any given code from this straight line is measured from the center of that code value.

INTERMODULATION DISTORTION (IMD) is the creation of additional spectral components as a result of two sinusoidal frequencies being applied to the ADC input at the same time. It is defined as the ratio of the power in the intermodulation products to the total power in the original frequencies. IMD is usually expressed in dBFS.

LSB (LEAST SIGNIFICANT BIT) is the bit that has the smallest value or weight of all bits. This value is $V_{FS}/2^n$, where “ V_{FS} ” is the full scale input voltage and “ n ” is the ADC resolution in bits.

MISSING CODES are those output codes that will never appear at the ADC outputs. The ADC12C105 is ensured not to have any missing codes.

MSB (MOST SIGNIFICANT BIT) is the bit that has the largest value or weight. Its value is one half of full scale.

NEGATIVE FULL SCALE ERROR is the difference between the actual first code transition and its ideal value of $1/2$ LSB above negative full scale.

OFFSET ERROR is the difference between the two input voltages $[(V_{IN+}) - (V_{IN-})]$ required to cause a transition from code 2047 to 2048.

OUTPUT DELAY is the time delay after the falling edge of the clock before the data update is presented at the output pins.

PIPELINE DELAY (LATENCY) See CONVERSION LATENCY.

POSITIVE FULL SCALE ERROR is the difference between the actual last code transition and its ideal value of $1/2$ LSB below positive full scale.

POWER SUPPLY REJECTION RATIO (PSRR) is a measure of how well the ADC rejects a change in the power supply voltage. PSRR is the ratio of the Full-Scale output of the ADC with the supply at the minimum DC supply limit to the Full-Scale output of the ADC with the supply at the maximum DC supply limit, expressed in dB.

SIGNAL TO NOISE RATIO (SNR) is the ratio, expressed in dB, of the rms value of the input signal to the rms value of the sum of all other spectral components below one-half the sampling frequency, not including harmonics or DC.

SIGNAL TO NOISE PLUS DISTORTION (S/N+D or SINAD) Is the ratio, expressed in dB, of the rms value of the input signal to the rms value of all of the other spectral components below half the clock frequency, including harmonics but excluding d.c.

SPURIOUS FREE DYNAMIC RANGE (SFDR) is the difference, expressed in dB, between the rms values of the input signal and the peak spurious signal, where a spurious signal is any signal present in the output spectrum that is not present at the input.

TOTAL HARMONIC DISTORTION (THD) is the ratio, expressed in dB, of the rms total of the first six harmonic levels at the output to the level of the fundamental at the output. THD is calculated as

$$\text{THD} = 20 \times \log \sqrt{\frac{f_2^2 + \dots + f_7^2}{f_1^2}} \quad (3)$$

where f_1 is the RMS power of the fundamental (output) frequency and f_2 through f_7 are the RMS power of the first six harmonic frequencies in the output spectrum.

SECOND HARMONIC DISTORTION (2ND HARM) is the difference expressed in dB, between the RMS power in the input frequency at the output and the power in its 2nd harmonic level at the output.

THIRD HARMONIC DISTORTION (3RD HARM) is the difference, expressed in dB, between the RMS power in the input frequency at the output and the power in its 3rd harmonic level at the output.

Timing Diagram

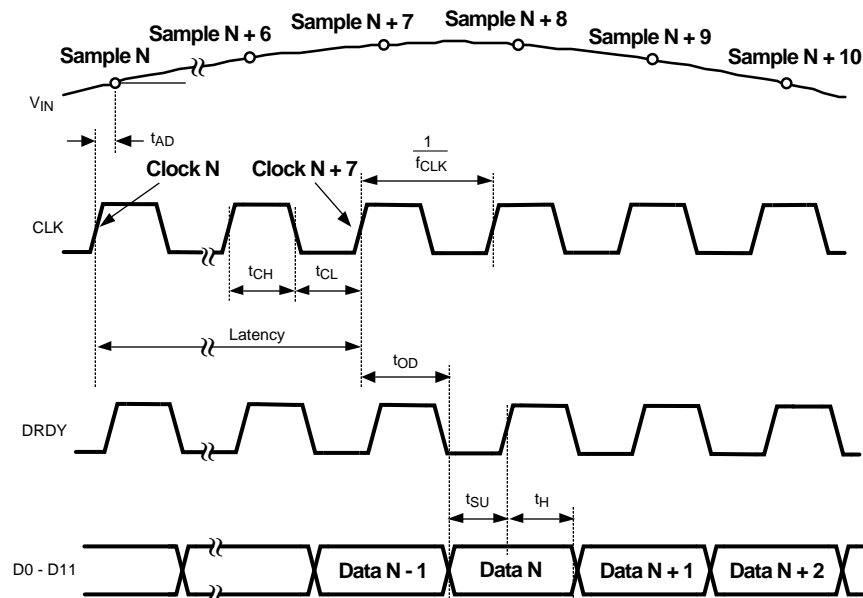

Figure 1. Output Timing

Transfer Characteristic

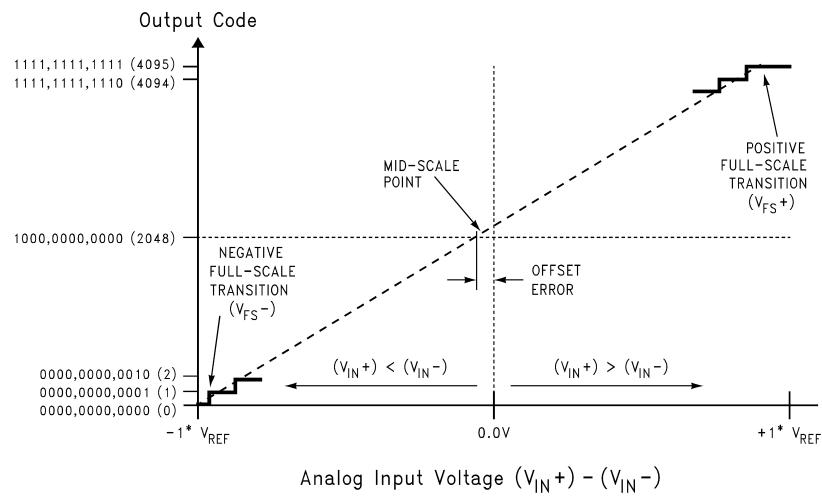

Figure 2. Transfer Characteristic

Typical Performance Characteristics DNL, INL

Unless otherwise specified, the following specifications apply: $AGND = DRGND = 0V$, $V_A = +3.3V$, $V_{DR} = +2.5V$, Internal $V_{REF} = +1.2V$, $f_{CLK} = 105\text{ MHz}$, 50% Duty Cycle, DCS disabled, $V_{CM} = V_{CMO}$, $f_{IN} = 10\text{ MHz}$, $C_L = 5\text{ pF/pin}$. Typical values are for $T_A = 25^\circ\text{C}$.

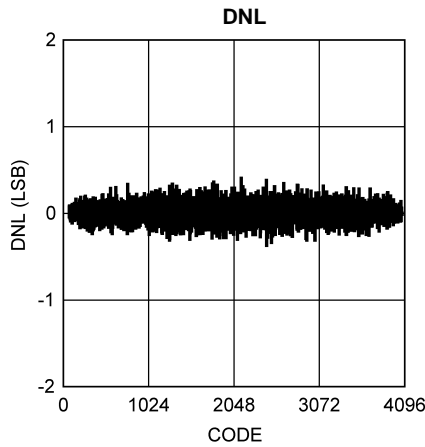

Figure 3.

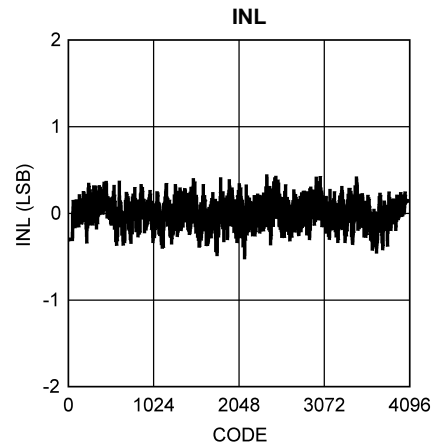

Figure 4.

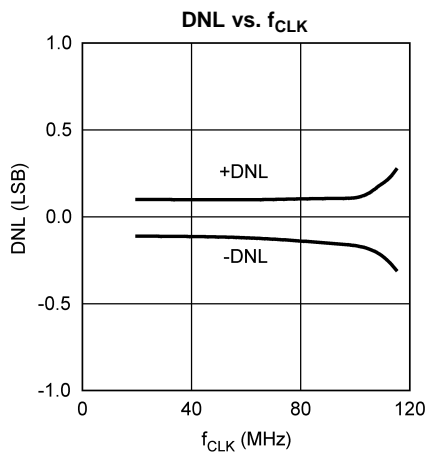

Figure 5.

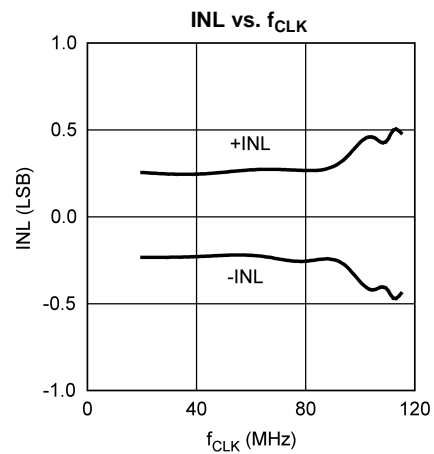

Figure 6.

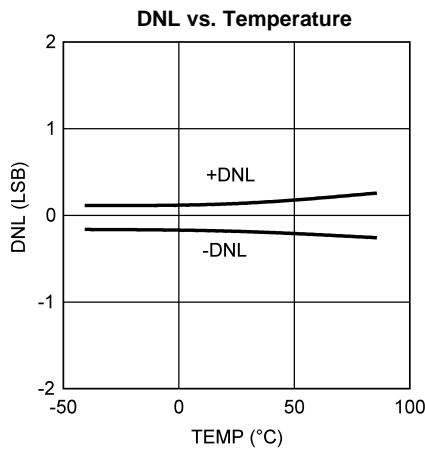

Figure 7.

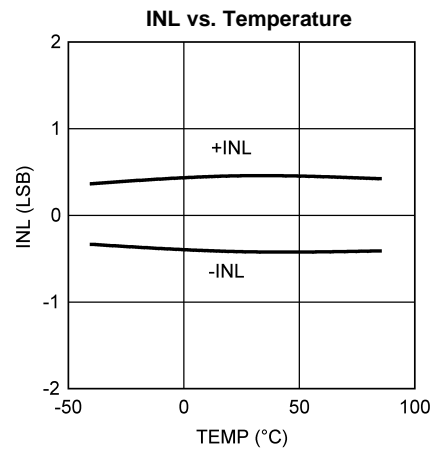

Figure 8.

Typical Performance Characteristics DNL, INL (continued)

Unless otherwise specified, the following specifications apply: AGND = DRGND = 0V, $V_A = +3.3V$, $V_{DR} = +2.5V$, Internal $V_{REF} = +1.2V$, $f_{CLK} = 105\text{ MHz}$, 50% Duty Cycle, DCS disabled, $V_{CM} = V_{CMO}$, $f_{IN} = 10\text{ MHz}$, $C_L = 5\text{ pF/pin}$. Typical values are for $T_A = 25^\circ\text{C}$.

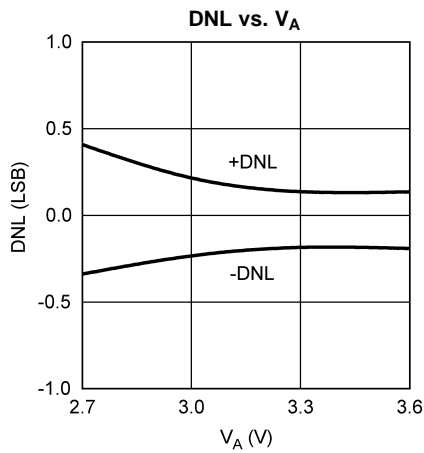

Figure 9.

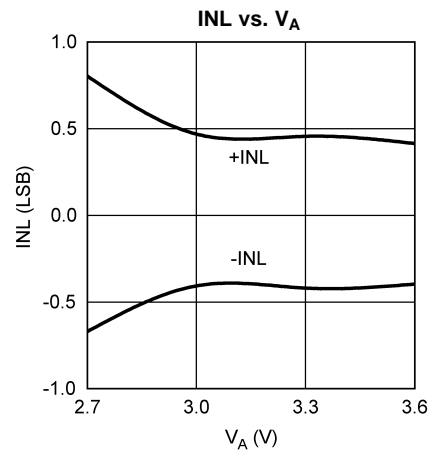

Figure 10.

Typical Performance Characteristics

Unless otherwise specified, the following specifications apply: $AGND = DRGND = 0V$, $V_A = +3.3V$, $V_{DR} = +2.5V$, Internal $V_{REF} = +1.2V$, $f_{CLK} = 105\text{ MHz}$, 50% Duty Cycle, DCS disabled, $V_{CM} = V_{CMO}$, $f_{IN} = 10\text{ MHz}$, $C_L = 5\text{ pF/pin}$. Typical values are for $T_A = 25^\circ\text{C}$.

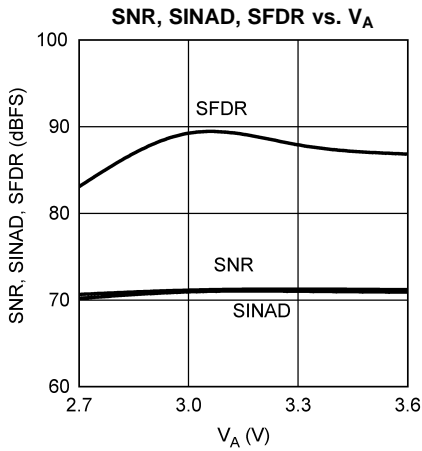

Figure 11.

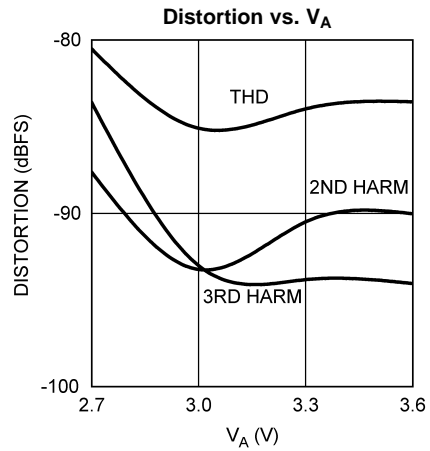

Figure 12.

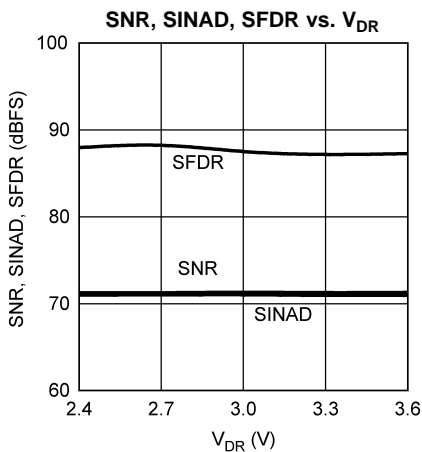

Figure 13.

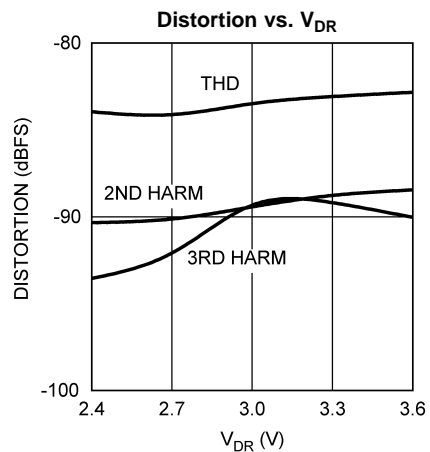

Figure 14.

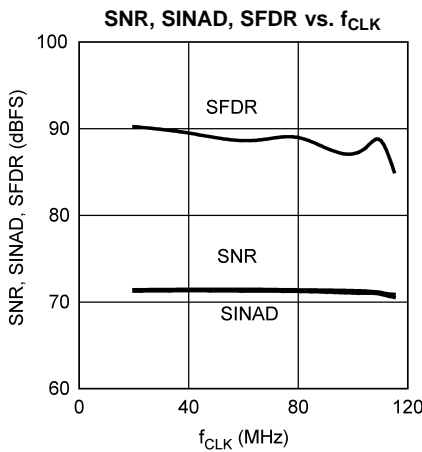

Figure 15.

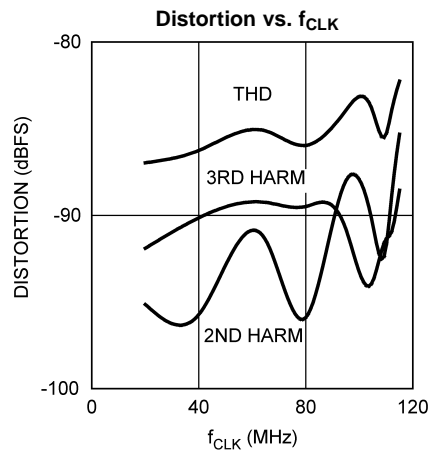

Figure 16.

Typical Performance Characteristics (continued)

Unless otherwise specified, the following specifications apply: AGND = DRGND = 0V, $V_A = +3.3V$, $V_{DR} = +2.5V$, Internal $V_{REF} = +1.2V$, $f_{CLK} = 105\text{ MHz}$, 50% Duty Cycle, DCS disabled, $V_{CM} = V_{CMO}$, $f_{IN} = 10\text{ MHz}$, $C_L = 5\text{ pF/pin}$. Typical values are for $T_A = 25^\circ\text{C}$.

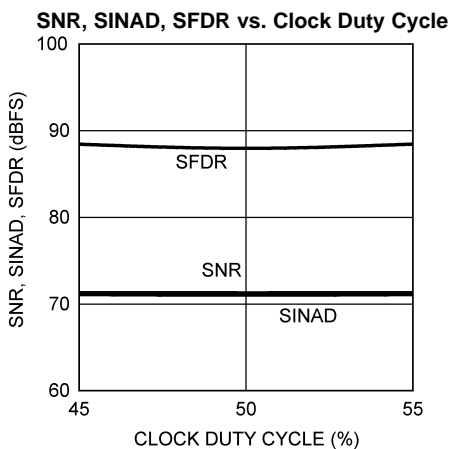

Figure 17.

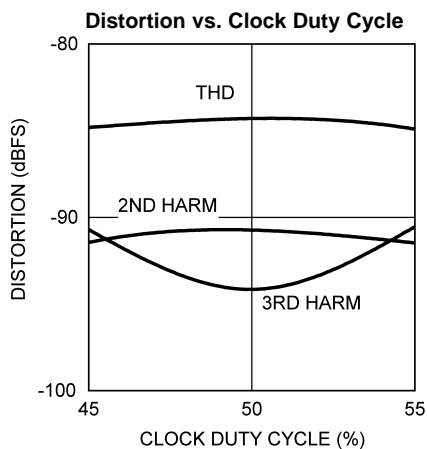

Figure 18.

SNR, SINAD, SFDR vs. Clock Duty Cycle, DCS Enabled

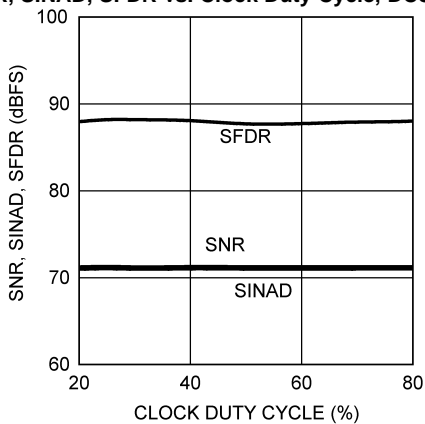

Figure 19.

Distortion vs. Clock Duty Cycle, DCS Enabled

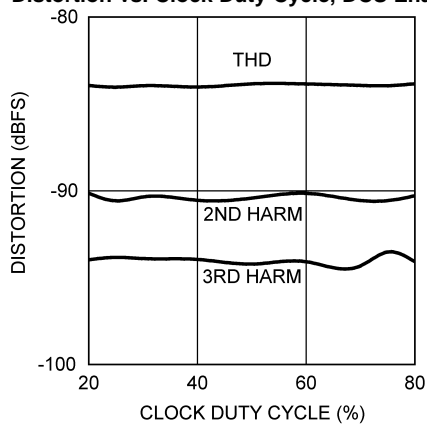

Figure 20.

SNR, SINAD, SFDR vs. f_{IN}

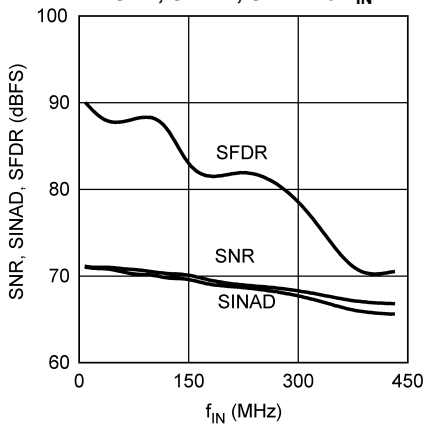

Figure 21.

Distortion vs. f_{IN}

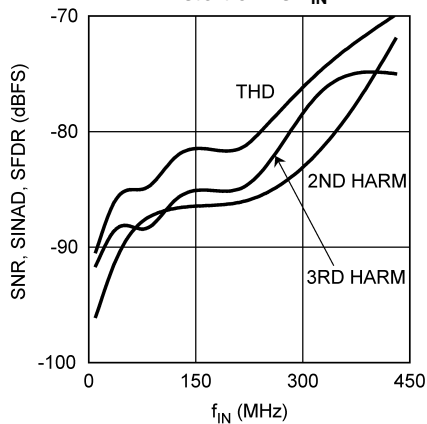

Figure 22.

Typical Performance Characteristics (continued)

Unless otherwise specified, the following specifications apply: AGND = DRGND = 0V, $V_A = +3.3V$, $V_{DR} = +2.5V$, Internal $V_{REF} = +1.2V$, $f_{CLK} = 105\text{ MHz}$, 50% Duty Cycle, DCS disabled, $V_{CM} = V_{CMO}$, $f_{IN} = 10\text{ MHz}$, $C_L = 5\text{ pF/pin}$. Typical values are for $T_A = 25^\circ\text{C}$.

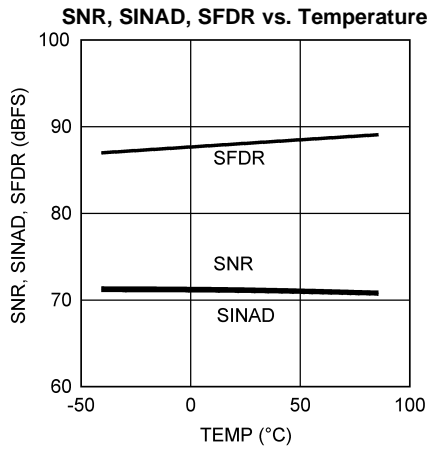

Figure 23.

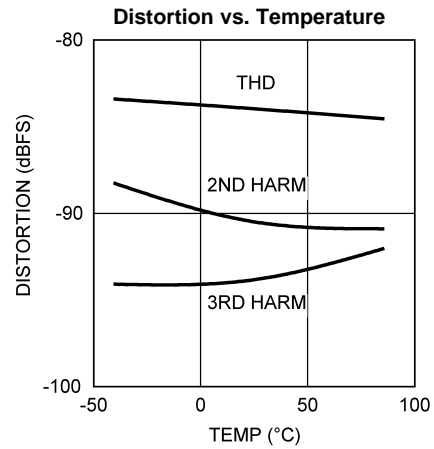

Figure 24.

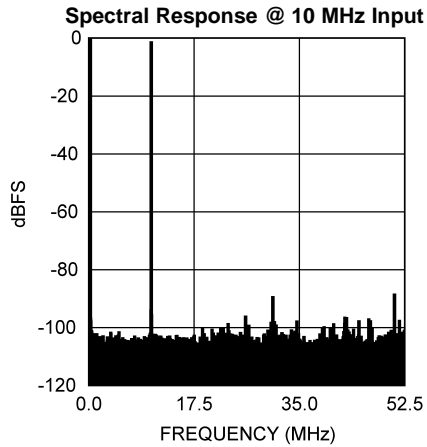

Figure 25.

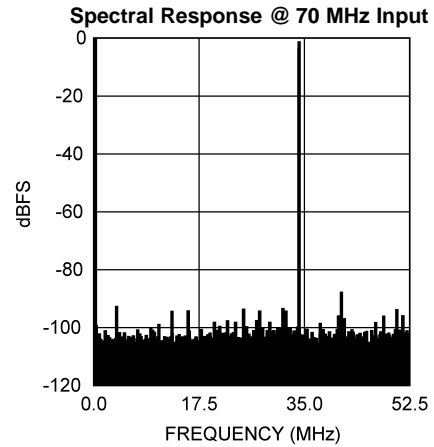

Figure 26.

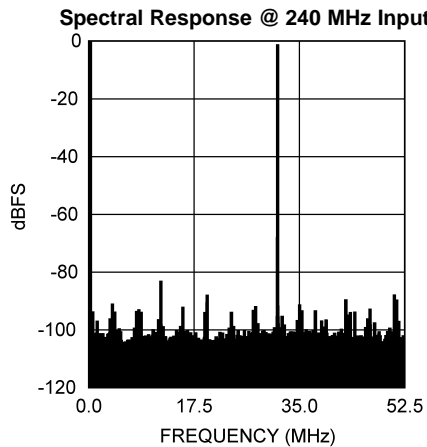

Figure 27.

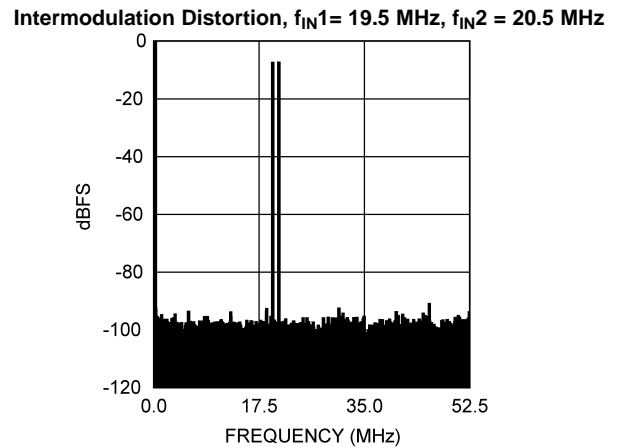

Figure 28.

Typical Performance Characteristics (continued)

Unless otherwise specified, the following specifications apply: AGND = DRGND = 0V, $V_A = +3.3V$, $V_{DR} = +2.5V$, Internal $V_{REF} = +1.2V$, $f_{CLK} = 105\text{ MHz}$, 50% Duty Cycle, DCS disabled, $V_{CM} = V_{CMO}$, $f_{IN} = 10\text{ MHz}$, $C_L = 5\text{ pF/pin}$. Typical values are for $T_A = 25^\circ\text{C}$.

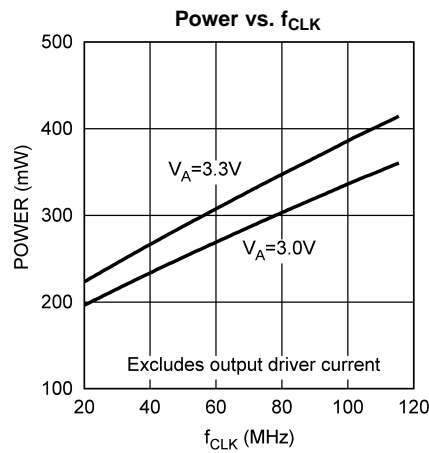

Figure 29.

FUNCTIONAL DESCRIPTION

Operating on a single +3.3V supply, the ADC12C105 uses a pipeline architecture and has error correction circuitry to help ensure maximum performance. The differential analog input signal is digitized to 12 bits. The user has the choice of using an internal 1.2V stable reference, or using an external 1.2V reference. Any external reference is buffered on-chip to ease the task of driving that pin.

The output word rate is the same as the clock frequency. The analog input is acquired at the rising edge of the clock and the digital data for a given sample is delayed by the pipeline for 7 clock cycles. The digital outputs are CMOS compatible signals that are clocked by a synchronous data ready output signal (DRDY, pin 21) at the same rate as the clock input. Duty cycle stabilization and output data format are selectable using the quad state function OF/DCS pin (pin 12). The output data can be set for offset binary or two's complement.

Power-down is selectable using the PD pin (pin 30). A logic high on the PD pin reduces the converter power consumption. For normal operation, the PD pin should be connected to the analog ground (AGND).

Applications Information

OPERATING CONDITIONS

We recommend that the following conditions be observed for operation of the ADC12C105:

$$2.7V \leq V_A \leq 3.6V$$

$$2.4V \leq V_{DR} \leq V_A$$

$$20 \text{ MHz} \leq f_{CLK} \leq 105 \text{ MHz}$$

1.2V internal reference

$$V_{REF} = 1.2V \text{ (for an external reference)}$$

$$V_{CM} = 1.5V \text{ (from } V_{CMO})$$

ANALOG INPUTS

Signal Inputs

Differential Analog Input Pins

The ADC12C105 has one pair of analog signal input pins, V_{IN+} and V_{IN-} , which form a differential input pair. The input signal, V_{IN} , is defined as

$$V_{IN} = (V_{IN+}) - (V_{IN-}) \quad (4)$$

Figure 30 shows the expected input signal range. Note that the common mode input voltage, V_{CM} , should be 1.5V. Using V_{CMO} (pin 32) for V_{CM} will ensure the proper input common mode level for the analog input signal. The positive peaks of the individual input signals should each never exceed 2.6V. Each analog input pin of the differential pair should have a maximum peak-to-peak voltage of 1V, be 180° out of phase with each other and be centered around V_{CM} . The peak-to-peak voltage swing at each analog input pin should not exceed the 1V or the output data will be clipped.

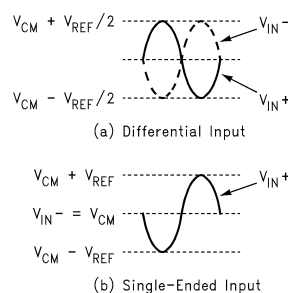

Figure 30. Expected Input Signal Range

For single frequency sine waves the full scale error in LSB can be described as approximately

$$E_{FS} = 4096 (1 - \sin(90^\circ + \text{dev})) \tag{5}$$

Where dev is the angular difference in degrees between the two signals having a 180° relative phase relationship to each other (see Figure 31). For single frequency inputs, angular errors result in a reduction of the effective full scale input. For complex waveforms, however, angular errors will result in distortion.

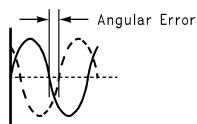

Figure 31. Angular Errors Between the Two Input Signals Will Reduce the Output Level or Cause Distortion

It is recommended to drive the analog inputs with a source impedance less than 100Ω. Matching the source impedance for the differential inputs will improve even ordered harmonic performance (particularly second harmonic).

Table 1 indicates the input to output relationship of the ADC12C105.

Table 1. Input to Output Relationship

V _{IN+}	V _{IN-}	Binary Output	2's Complement Output	
V _{CM} - V _{REF/2}	V _{CM} + V _{REF/2}	0000 0000 0000	1000 0000 0000	Negative Full-Scale
V _{CM} - V _{REF/4}	V _{CM} + V _{REF/4}	0100 0000 0000	1100 0000 0000	
V _{CM}	V _{CM}	1000 0000 0000	0000 0000 0000	Mid-Scale
V _{CM} + V _{REF/4}	V _{CM} - V _{REF/4}	1100 0000 0000	0100 0000 0000	
V _{CM} + V _{REF/2}	V _{CM} - V _{REF/2}	1111 1111 1111	0111 1111 1111	Positive Full-Scale

Driving the Analog Inputs

The V_{IN+} and the V_{IN-} inputs of the ADC12C105 have an internal sample-and-hold circuit which consists of an analog switch followed by a switched-capacitor amplifier.

Figure 32 and Figure 32 show examples of single-ended to differential conversion circuits. The circuit in Figure 32 works well for input frequencies up to approximately 70MHz, while the circuit in Figure 33 works well above 70MHz.

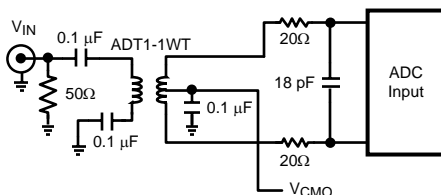

Figure 32. Low Input Frequency Transformer Drive Circuit

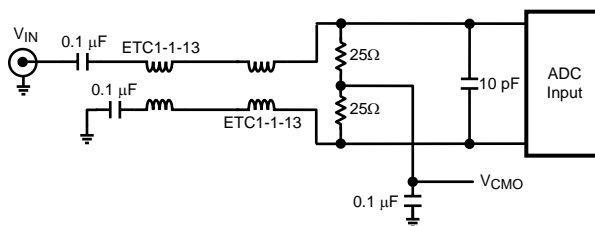

Figure 33. High Input Frequency Transformer Drive Circuit

One short-coming of using a transformer to achieve the single-ended to differential conversion is that most RF transformers have poor low frequency performance. A differential amplifier can be used to drive the analog inputs for low frequency applications. The amplifier must be fast enough to settle from the charging glitches on the analog input resulting from the sample-and-hold operation before the clock goes high and the sample is passed to the ADC core.

The SFDR performance of the converter depends on the external signal conditioning circuitry used, as this affects how quickly the sample-and-hold charging glitch will settle. An external resistor and capacitor network as shown in [Figure 34](#) should be used to isolate the charging glitches at the ADC input from the external driving circuit and to filter the wideband noise at the converter input. These components should be placed close to the ADC inputs because the analog input of the ADC is the most sensitive part of the system, and this is the last opportunity to filter that input. For Nyquist applications the RC pole should be at the ADC sample rate. The ADC input capacitance in the sample mode should be considered when setting the RC pole. For wideband undersampling applications, the RC pole should be set at least 1.5 to 2 times the maximum input frequency to maintain a linear delay response.

Input Common Mode Voltage

The input common mode voltage, V_{CM} , should be in the range of 1.4V to 1.6V and be a value such that the peak excursions of the analog signal do not go more negative than ground or more positive than 2.6V. It is recommended to use V_{CMO} (pin 32) as the input common mode voltage.

If the ADC12C105 is operated with $V_A=3.6V$, a resistor of approximately 1K Ω should be used from the V_{CMO} pin to AGND. This will help maintain stability over the entire temperature range when using a high supply voltage.

Reference Pins

The ADC12C105 is designed to operate with an internal or external 1.2V reference. The internal 1.2 Volt reference is the default condition when no external reference input is applied to the V_{REF} pin. If a voltage is applied to the V_{REF} pin, then that voltage is used for the reference. The V_{REF} pin should always be bypassed to ground with a 0.1 μF capacitor close to the reference input pin.

It is important that all grounds associated with the reference voltage and the analog input signal make connection to the ground plane at a single, quiet point to minimize the effects of noise currents in the ground path.

The Reference Bypass Pins (V_{RP} , V_{CMO} , and V_{RN}) are made available for bypass purposes. These pins should each be bypassed to AGND with a low ESL (equivalent series inductance) 1 μF capacitor placed very close to the pin to minimize stray inductance. A 0.1 μF capacitor should be placed between V_{RP} and V_{RN} as close to the pins as possible, and a 1 μF capacitor should be placed in parallel. This configuration is shown in [Figure 34](#). It is necessary to avoid reference oscillation, which could result in reduced SFDR and/or SNR. V_{CMO} may be loaded to 1mA for use as a temperature stable 1.5V reference. The remaining pins should not be loaded.

Smaller capacitor values than those specified will allow faster recovery from the power down mode, but may result in degraded noise performance. Loading any of these pins, other than V_{CMO} may result in performance degradation.

The nominal voltages for the reference bypass pins are as follows:

$$V_{CMO} = 1.5 \text{ V}$$

$$V_{RP} = 2.0 \text{ V}$$

$$V_{RN} = 1.0 \text{ V}$$

OF/DCS Pin

Duty cycle stabilization and output data format are selectable using this quad state function pin. When enabled, duty cycle stabilization can compensate for clock inputs with duty cycles ranging from 30% to 70% and generate a stable internal clock, improving the performance of the part. With OF/DCS = V_A the output data format is 2's complement and duty cycle stabilization is not used. With OF/DCS = AGND the output data format is offset binary and duty cycle stabilization is not used. With OF/DCS = $(2/3)*V_A$ the output data format is 2's complement and duty cycle stabilization is applied to the clock. If OF/DCS is $(1/3)*V_A$ the output data format is offset binary and duty cycle stabilization is applied to the clock. While the sense of this pin may be changed "on the fly," doing this is not recommended as the output data could be erroneous for a few clock cycles after this change is made.

DIGITAL INPUTS

Digital CMOS compatible inputs consist of CLK, and PD.

Clock Input

The CLK controls the timing of the sampling process. To achieve the optimum noise performance, the clock input should be driven with a stable, low jitter clock signal in the range indicated in the [Electrical Table](#). The clock input signal should also have a short transition region. This can be achieved by passing a low-jitter sinusoidal clock source through a high speed buffer gate. The trace carrying the clock signal should be as short as possible and should not cross any other signal line, analog or digital, not even at 90°.

The clock signal also drives an internal state machine. If the clock is interrupted, or its frequency is too low, the charge on the internal capacitors can dissipate to the point where the accuracy of the output data will degrade. This is what limits the minimum sample rate.

The clock line should be terminated at its source in the characteristic impedance of that line. Take care to maintain a constant clock line impedance throughout the length of the line. Refer to Application Note AN-905 ([SNLA035](#)) for information on setting characteristic impedance.

It is highly desirable that the the source driving the ADC clock pins only drive that pin. However, if that source is used to drive other devices, then each driven pin should be AC terminated with a series RC to ground, such that the resistor value is equal to the characteristic impedance of the clock line and the capacitor value is

$$C \geq \frac{4 \times t_{PD} \times L}{Z_0} \quad (6)$$

where t_{PD} is the signal propagation rate down the clock line, "L" is the line length and Z_0 is the characteristic impedance of the clock line. This termination should be as close as possible to the ADC clock pin but beyond it as seen from the clock source. Typical t_{PD} is about 150 ps/inch (60 ps/cm) on FR-4 board material. The units of "L" and t_{PD} should be the same (inches or centimeters).

The duty cycle of the clock signal can affect the performance of the A/D Converter. Because achieving a precise duty cycle is difficult, the ADC12C105 has a Duty Cycle Stabilizer. It is designed to maintain performance over a clock duty cycle range of 30% to 70%.

Power-Down (PD)

The PD pin, when high, holds the ADC12C105 in a power-down mode to conserve power when the converter is not being used. The power consumption in this state is 5 mW if the clock is stopped when PD is high. The output data pins are undefined and the data in the pipeline is corrupted while in the power down mode.

The Power Down Mode Exit Cycle time is determined by the value of the components on pins 1, 2, and 32 and is about 3 ms with the recommended components on the V_{RP} , V_{CMO} and V_{RN} reference bypass pins. These capacitors lose their charge in the Power Down mode and must be recharged by on-chip circuitry before conversions can be accurate. Smaller capacitor values allow slightly faster recovery from the power down mode, but can result in a reduction in SNR, SINAD and ENOB performance.

DIGITAL OUTPUTS

Digital outputs consist of the CMOS signals D0-D11, and DRDY.

The ADC12C105 has 13 CMOS compatible data output pins corresponding to the converted input value and a data ready (DRDY) signal that should be used to capture the output data. Valid data is present at these outputs while the PD pin is low. Data should be captured and latched with the rising edge of the DRDY signal.

Be very careful when driving a high capacitance bus. The more capacitance the output drivers must charge for each conversion, the more instantaneous digital current flows through V_{DR} and DRGND. These large charging current spikes can cause on-chip ground noise and couple into the analog circuitry, degrading dynamic performance. Adequate bypassing, limiting output capacitance and careful attention to the ground plane will reduce this problem. The result could be an apparent reduction in dynamic performance.

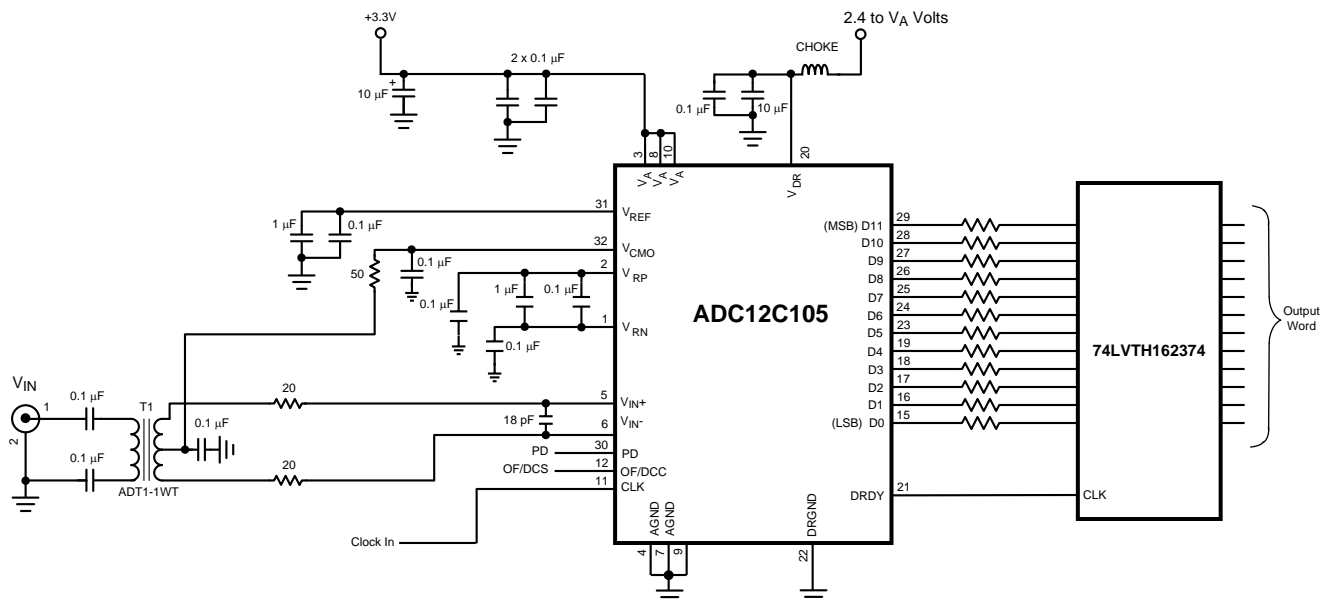

Figure 34. Application Circuit

POWER SUPPLY CONSIDERATIONS

The power supply pins should be bypassed with a 0.1 μF capacitor and with a 100 pF ceramic chip capacitor close to each power pin. Leadless chip capacitors are preferred because they have low series inductance.

As is the case with all high-speed converters, the ADC12C105 is sensitive to power supply noise. Accordingly, the noise on the analog supply pin should be kept below 100 mV_{P-P}.

No pin should ever have a voltage on it that is in excess of the supply voltages, not even on a transient basis. Be especially careful of this during power turn on and turn off.

The V_{DR} pin provides power for the output drivers and may be operated from a supply in the range of 2.4V to V_A. This enables lower power operation, reduces the noise coupling effects from the digital outputs to the analog circuitry and simplifies interfacing to lower voltage devices and systems.

LAYOUT AND GROUNDING

Proper grounding and proper routing of all signals are essential to ensure accurate conversion. Maintaining separate analog and digital areas of the board, with the ADC12C105 between these areas, is required to achieve specified performance.

The ground return for the data outputs (DRGND) carries the ground current for the output drivers. The output current can exhibit high transients that could add noise to the conversion process. To prevent this from happening, the DRGND pins should NOT be connected to system ground in close proximity to any of the ADC12C105's other ground pins.

Capacitive coupling between the typically noisy digital circuitry and the sensitive analog circuitry can lead to poor performance. The solution is to keep the analog circuitry separated from the digital circuitry, and to keep the clock line as short as possible.

The effects of the noise generated from the ADC output switching can be minimized through the use of 22 Ω resistors in series with each data output line. Locate these resistors as close to the ADC output pins as possible.

Since digital switching transients are composed largely of high frequency components, total ground plane copper weight will have little effect upon the logic-generated noise. This is because of the skin effect. Total surface area is more important than is total ground plane area.

Generally, analog and digital lines should cross each other at 90° to avoid crosstalk. To maximize accuracy in high speed, high resolution systems, however, avoid crossing analog and digital lines altogether. It is important to keep clock lines as short as possible and isolated from ALL other lines, including other digital lines. Even the generally accepted 90° crossing should be avoided with the clock line as even a little coupling can cause problems at high frequencies. This is because other lines can introduce jitter into the clock line, which can lead to degradation of SNR. Also, the high speed clock can introduce noise into the analog chain.

Best performance at high frequencies and at high resolution is obtained with a straight signal path. That is, the signal path through all components should form a straight line wherever possible.

Be especially careful with the layout of inductors and transformers. Mutual inductance can change the characteristics of the circuit in which they are used. Inductors and transformers should *not* be placed side by side, even with just a small part of their bodies beside each other. For instance, place transformers for the analog input and the clock input at 90° to one another to avoid magnetic coupling.

The analog input should be isolated from noisy signal traces to avoid coupling of spurious signals into the input. Any external component (e.g., a filter capacitor) connected between the converter's input pins and ground or to the reference input pin and ground should be connected to a very clean point in the ground plane.

All analog circuitry (input amplifiers, filters, reference components, etc.) should be placed in the analog area of the board. All digital circuitry and dynamic I/O lines should be placed in the digital area of the board. The ADC12C105 should be between these two areas. Furthermore, all components in the reference circuitry and the input signal chain that are connected to ground should be connected together with short traces and enter the ground plane at a single, quiet point. All ground connections should have a low inductance path to ground.

DYNAMIC PERFORMANCE

To achieve the best dynamic performance, the clock source driving the CLK input must have a sharp transition region and be free of jitter. Isolate the ADC clock from any digital circuitry with buffers, as with the clock tree shown in [Figure 35](#). The gates used in the clock tree must be capable of operating at frequencies much higher than those used if added jitter is to be prevented.

As mentioned in [LAYOUT AND GROUNDING](#), it is good practice to keep the ADC clock line as short as possible and to keep it well away from any other signals. Other signals can introduce jitter into the clock signal, which can lead to reduced SNR performance, and the clock can introduce noise into other lines. Even lines with 90° crossings have capacitive coupling, so try to avoid even these 90° crossings of the clock line.

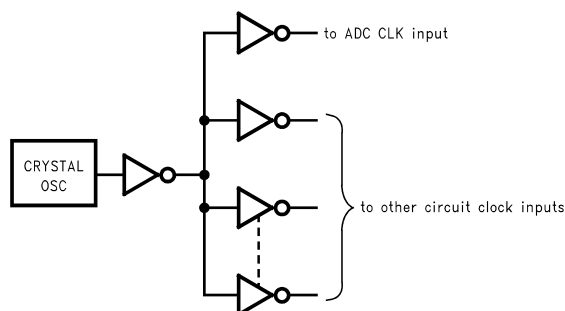

Figure 35. Isolating the ADC Clock from other Circuitry with a Clock Tree

REVISION HISTORY

Changes from Revision B (April 2013) to Revision C	Page
• Changed layout of National Data Sheet to TI format	25

PACKAGING INFORMATION

Orderable Device	Status (1)	Package Type	Package Drawing	Pins	Package Qty	Eco Plan (2)	Lead finish/ Ball material (6)	MSL Peak Temp (3)	Op Temp (°C)	Device Marking (4/5)	Samples
ADC12C105CISQ/NOPB	ACTIVE	WQFN	RTV	32	1000	RoHS & Green	SN	Level-3-260C-168 HR	-40 to 85	12C105	Samples
ADC12C105CISQE/NOPB	ACTIVE	WQFN	RTV	32	250	RoHS & Green	SN	Level-3-260C-168 HR	-40 to 85	12C105	Samples

(1) The marketing status values are defined as follows:

ACTIVE: Product device recommended for new designs.

LIFEBUY: TI has announced that the device will be discontinued, and a lifetime-buy period is in effect.

NRND: Not recommended for new designs. Device is in production to support existing customers, but TI does not recommend using this part in a new design.

PREVIEW: Device has been announced but is not in production. Samples may or may not be available.

OBSELETE: TI has discontinued the production of the device.

(2) **RoHS:** TI defines "RoHS" to mean semiconductor products that are compliant with the current EU RoHS requirements for all 10 RoHS substances, including the requirement that RoHS substance do not exceed 0.1% by weight in homogeneous materials. Where designed to be soldered at high temperatures, "RoHS" products are suitable for use in specified lead-free processes. TI may reference these types of products as "Pb-Free".

RoHS Exempt: TI defines "RoHS Exempt" to mean products that contain lead but are compliant with EU RoHS pursuant to a specific EU RoHS exemption.

Green: TI defines "Green" to mean the content of Chlorine (Cl) and Bromine (Br) based flame retardants meet JS709B low halogen requirements of <=1000ppm threshold. Antimony trioxide based flame retardants must also meet the <=1000ppm threshold requirement.

(3) MSL, Peak Temp. - The Moisture Sensitivity Level rating according to the JEDEC industry standard classifications, and peak solder temperature.

(4) There may be additional marking, which relates to the logo, the lot trace code information, or the environmental category on the device.

(5) Multiple Device Markings will be inside parentheses. Only one Device Marking contained in parentheses and separated by a "~" will appear on a device. If a line is indented then it is a continuation of the previous line and the two combined represent the entire Device Marking for that device.

(6) Lead finish/Ball material - Orderable Devices may have multiple material finish options. Finish options are separated by a vertical ruled line. Lead finish/Ball material values may wrap to two lines if the finish value exceeds the maximum column width.

Important Information and Disclaimer:The information provided on this page represents TI's knowledge and belief as of the date that it is provided. TI bases its knowledge and belief on information provided by third parties, and makes no representation or warranty as to the accuracy of such information. Efforts are underway to better integrate information from third parties. TI has taken and continues to take reasonable steps to provide representative and accurate information but may not have conducted destructive testing or chemical analysis on incoming materials and chemicals. TI and TI suppliers consider certain information to be proprietary, and thus CAS numbers and other limited information may not be available for release.

In no event shall TI's liability arising out of such information exceed the total purchase price of the TI part(s) at issue in this document sold by TI to Customer on an annual basis.

TAPE AND REEL INFORMATION

QUADRANT ASSIGNMENTS FOR PIN 1 ORIENTATION IN TAPE



*All dimensions are nominal

Device	Package Type	Package Drawing	Pins	SPQ	Reel Diameter (mm)	Reel Width W1 (mm)	A0 (mm)	B0 (mm)	K0 (mm)	P1 (mm)	W (mm)	Pin1 Quadrant
ADC12C105CISQ/NOPB	WQFN	RTV	32	1000	178.0	12.4	5.3	5.3	1.3	8.0	12.0	Q1
ADC12C105CISQE/NOPB	WQFN	RTV	32	250	178.0	12.4	5.3	5.3	1.3	8.0	12.0	Q1

TAPE AND REEL BOX DIMENSIONS

*All dimensions are nominal

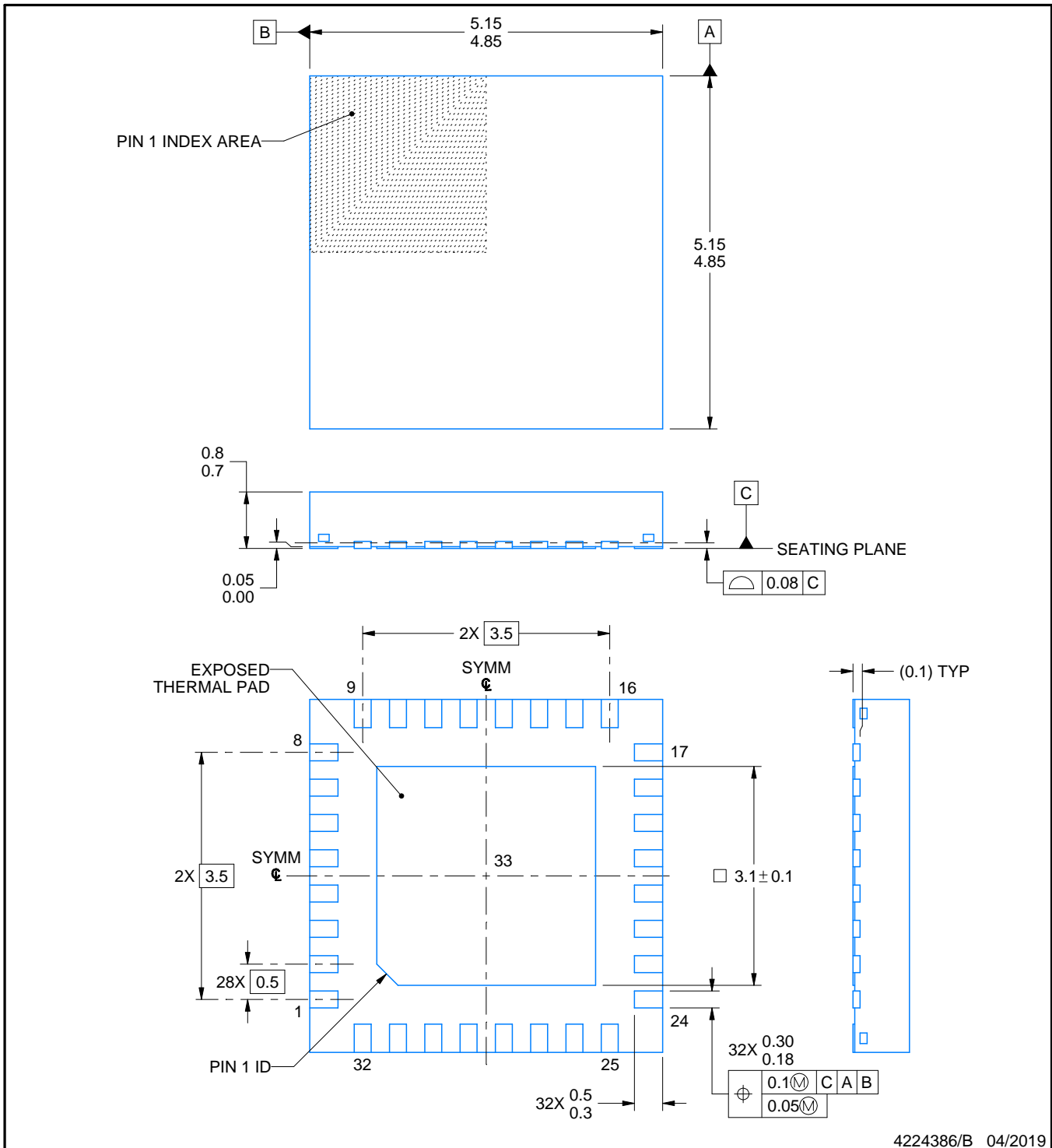
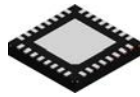
Device	Package Type	Package Drawing	Pins	SPQ	Length (mm)	Width (mm)	Height (mm)
ADC12C105CISQ/NOPB	WQFN	RTV	32	1000	208.0	191.0	35.0
ADC12C105CISQE/NOPB	WQFN	RTV	32	250	208.0	191.0	35.0



NOTES:

1. All linear dimensions are in millimeters. Any dimensions in parenthesis are for reference only. Dimensioning and tolerancing per ASME Y14.5M.
2. This drawing is subject to change without notice.
3. The package thermal pad must be soldered to the printed circuit board for thermal and mechanical performance.

EXAMPLE BOARD LAYOUT

RTV0032A

WQFN - 0.8 mm max height

PLASTIC QUAD FLATPACK - NO LEAD

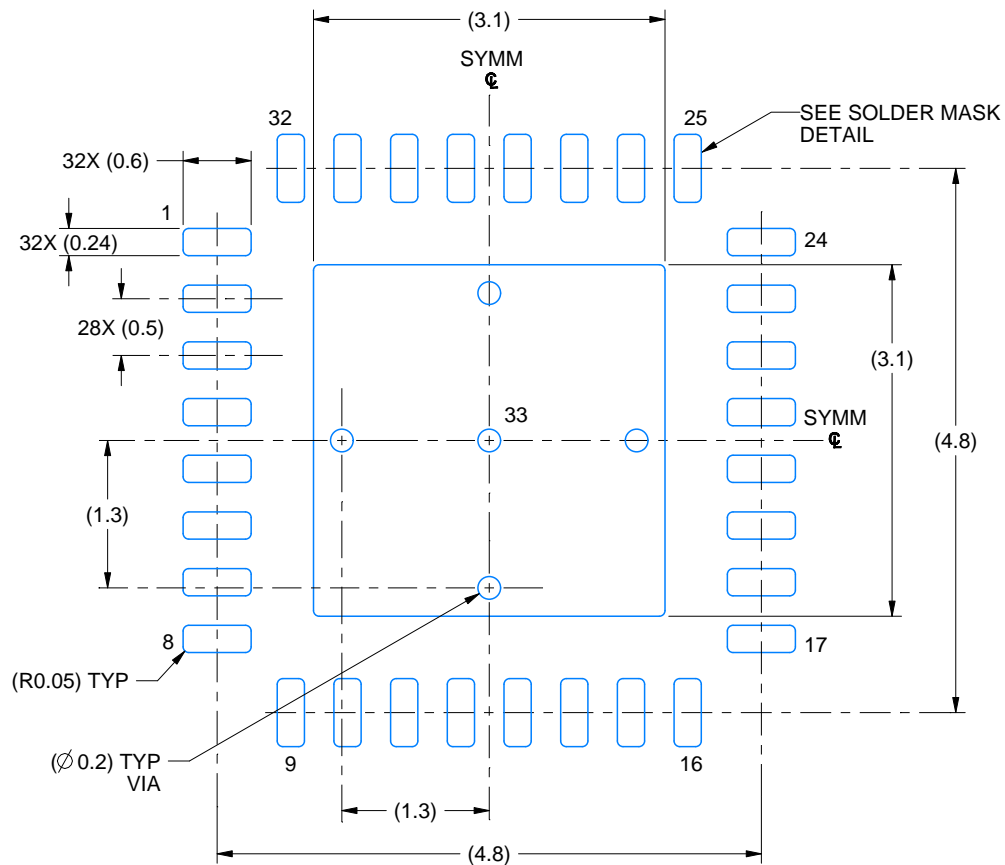

LAND PATTERN EXAMPLE
EXPOSED METAL SHOWN
SCALE: 15X



4224386/B 04/2019

NOTES: (continued)

4. This package is designed to be soldered to a thermal pad on the board. For more information, see Texas Instruments literature number SLUA271 (www.ti.com/lit/sluea271).
5. Vias are optional depending on application, refer to device data sheet. If any vias are implemented, refer to their locations shown on this view. It is recommended that vias under paste be filled, plugged or tented.

EXAMPLE STENCIL DESIGN

RTV0032A

WQFN - 0.8 mm max height

PLASTIC QUAD FLATPACK - NO LEAD

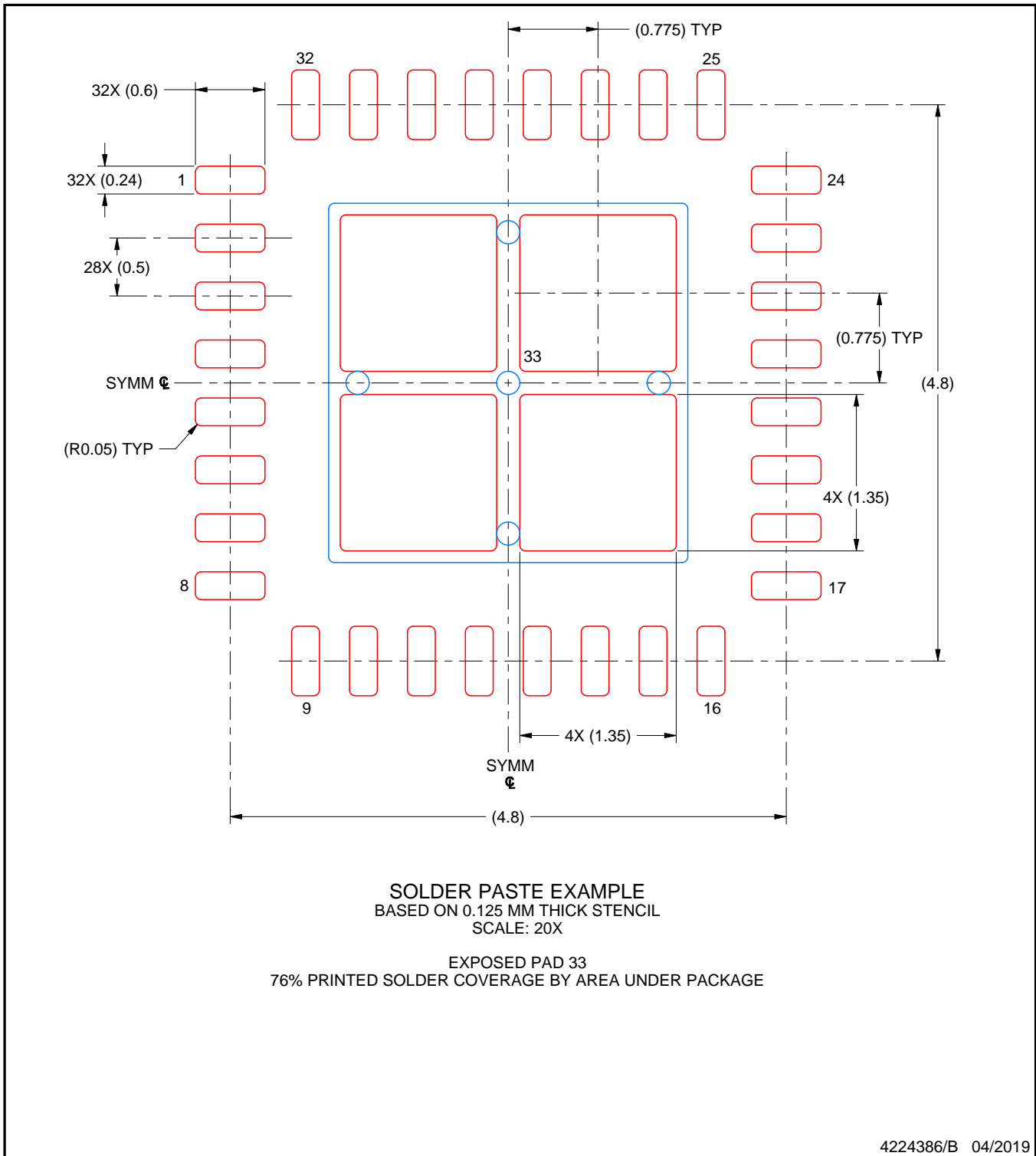

NOTES: (continued)

6. Laser cutting apertures with trapezoidal walls and rounded corners may offer better paste release. IPC-7525 may have alternate design recommendations.

IMPORTANT NOTICE AND DISCLAIMER

TI PROVIDES TECHNICAL AND RELIABILITY DATA (INCLUDING DATA SHEETS), DESIGN RESOURCES (INCLUDING REFERENCE DESIGNS), APPLICATION OR OTHER DESIGN ADVICE, WEB TOOLS, SAFETY INFORMATION, AND OTHER RESOURCES "AS IS" AND WITH ALL FAULTS, AND DISCLAIMS ALL WARRANTIES, EXPRESS AND IMPLIED, INCLUDING WITHOUT LIMITATION ANY IMPLIED WARRANTIES OF MERCHANTABILITY, FITNESS FOR A PARTICULAR PURPOSE OR NON-INFRINGEMENT OF THIRD PARTY INTELLECTUAL PROPERTY RIGHTS.

These resources are intended for skilled developers designing with TI products. You are solely responsible for (1) selecting the appropriate TI products for your application, (2) designing, validating and testing your application, and (3) ensuring your application meets applicable standards, and any other safety, security, regulatory or other requirements.

These resources are subject to change without notice. TI grants you permission to use these resources only for development of an application that uses the TI products described in the resource. Other reproduction and display of these resources is prohibited. No license is granted to any other TI intellectual property right or to any third party intellectual property right. TI disclaims responsibility for, and you will fully indemnify TI and its representatives against, any claims, damages, costs, losses, and liabilities arising out of your use of these resources.

TI's products are provided subject to [TI's Terms of Sale](#) or other applicable terms available either on ti.com or provided in conjunction with such TI products. TI's provision of these resources does not expand or otherwise alter TI's applicable warranties or warranty disclaimers for TI products.

TI objects to and rejects any additional or different terms you may have proposed.

Mailing Address: Texas Instruments, Post Office Box 655303, Dallas, Texas 75265
Copyright © 2022, Texas Instruments Incorporated