

2.5 V 1:5 Dual Differential LVDS Compatible Clock Driver

MC100EP210S

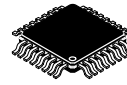

LQFP-32
 FA SUFFIX
 CASE 561AB

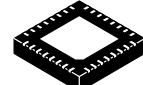

1 32
 QFN32
 MN SUFFIX
 CASE 488AM

Description

The MC100EP210S is a low skew 1-to-5 dual differential driver, designed with LVDS clock distribution in mind. The LVDS or LVPECL input signals are differential and the signal is fanned out to five identical differential LVDS outputs.

The EP210S specifically guarantees low output-to-output skew. Optimal design, layout, and processing minimize skew within a device and from device to device.

Two internal 50 Ω resistors are provided across the inputs. For LVDS inputs, VTA and VTB pins should be unconnected. For LVPECL inputs, VTA and VTB pins should be connected to the V_{TT} ($V_{CC} - 2.0$ V) supply.

Designers can take advantage of the EP210S performance to distribute low skew LVDS clocks across the backplane or the board.

Features

- 20 ps Typical Output-to-Output Skew
- 85 ps Typical Device-to-Device Skew
- 550 ps Typical Propagation Delay
- The 100 Series Contains Temperature Compensation
- Maximum Frequency > 1 GHz Typical
- Operating Range: $V_{CC} = 2.375$ V to 2.625 V with $V_{EE} = 0$ V
- Internal 50 Ω Input Termination Resistors
- LVDS Input/Output Compatible
- These are Pb-Free Devices

MARKING DIAGRAM

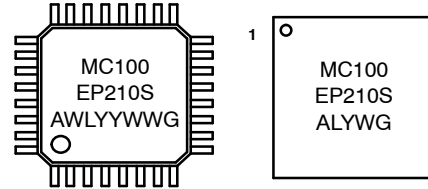

- A = Assembly Location
- WL, L = Wafer Lot
- YY, Y = Year
- WW, W = Work Week
- G = Pb-Free Package

*For additional marking information, refer to Application Note [AND8002/D](#).

ORDERING INFORMATION

See detailed ordering and shipping information in the package dimensions section on page 6 of this data sheet.

MC100EP210S

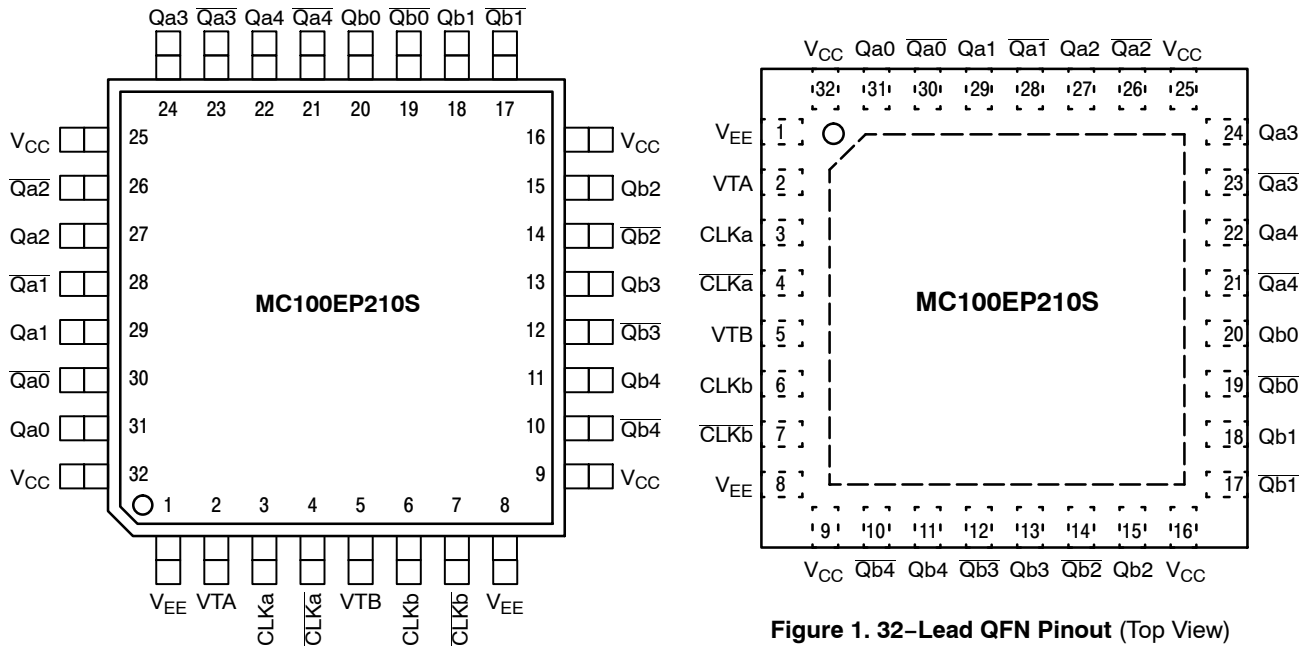

Figure 1. 32-Lead QFN Pinout (Top View)

Warning: All V_{CC} and V_{EE} pins must be externally connected to Power Supply to guarantee proper operation.

Figure 1. 32-Lead LQFP Pinout (Top View)

Table 1. PIN DESCRIPTION

PIN	FUNCTION
CLKn, $\overline{\text{CLKn}}$	LVDS, LVPECL CLK Inputs*
Qn0:4, $\overline{\text{Qn0:4}}$	LVDS Outputs
VTA	50 Ω Termination Resistors
VTB	50 Ω Termination Resistors
V _{CC}	Positive Supply
V _{EE}	Ground
EP for QFN-32, only	The Exposed Pad (EP) on the QFN-32 package bottom is thermally connected to the die for improved heat transfer out of package. The exposed pad must be attached to a heat-sinking conduit. The pad is electrically connected to V _{EE} .

*Under open or floating conditions with input pins converging to a common termination bias voltage the device is susceptible to auto oscillation.

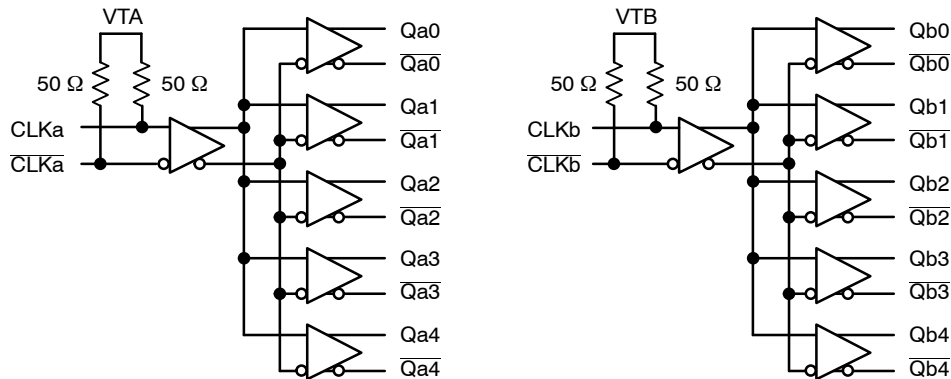

Figure 2. Logic Diagram

MC100EP210S

Table 2. ATTRIBUTES

Characteristics	Value	
ESD Protection	Human Body Model Machine Model Charged Device Model	> 2 kV > 100 V > 2 kV
Moisture Sensitivity, Indefinite Time Out of Drypack (Note 1)	Pb Pkg	Pb-Free Pkg
	LQFP-32 QFN-32	Level 2 Level 1
Flammability Rating	Oxygen Index: 28 to 34	UL 94 V-0 @ 0.125 in
Transistor Count	461 Devices	
Meets or exceeds JEDEC Spec EIA/JESD78 IC Latchup Test		

1. For additional information, refer to Application Note [AND8003/D](#).

Table 3. MAXIMUM RATINGS

Symbol	Parameter	Condition 1	Condition 2	Rating	Unit
V _{CC}	Power Supply	V _{EE} = 0 V		6	V
V _{EE}	Power Supply (GND)	V _{CC} = 2.5 V		-6	V
V _I	LVDS, LVPECL Input Voltage	V _{EE} = 0 V	V _I ≤ V _{CC}	6	V
I _{out}	Output Current	Continuous Surge		50 100	mA mA
T _A	Operating Temperature Range			-40 to +85	°C
T _{stg}	Storage Temperature Range			-65 to +150	°C
θ _{JA}	Thermal Resistance (Junction-to-Ambient)	0 lfpm 500 lfpm	32 LQFP 32 LQFP	80 55	°C/W °C/W
θ _{JC}	Thermal Resistance (Junction-to-Case)	Standard Board	32 LQFP	12 to 17	°C/W
θ _{JA}	Thermal Resistance (Junction-to-Ambient)	0 lfpm 500 lfpm	QFN-32 QFN-32	31 27	°C/W °C/W
θ _{JC}	Thermal Resistance (Junction-to-Case)	2S2P	QFN-32	12	°C/W
T _{sol}	Wave Solder	Pb Pb-Free		265 265	°C

Stresses exceeding those listed in the Maximum Ratings table may damage the device. If any of these limits are exceeded, device functionality should not be assumed, damage may occur and reliability may be affected.

MC100EP210S

Table 4. DC CHARACTERISTICS $V_{CC} = 2.5\text{ V}$, $V_{EE} = 0\text{ V}$ (Note 2)

Symbol	Characteristic	-40°C			25°C			85°C			Unit
		Min	Typ	Max	Min	Typ	Max	Min	Typ	Max	
I_{EE}	Power Supply Current		150	200		150	200		150	200	mA
V_{OH}	Output HIGH Voltage (Note 3)	1250	1400	1550	1250	1400	1550	1250	1400	1550	mV
V_{OL}	Output LOW Voltage (Note 3)	800	950	1100	800	950	1100	800	950	1100	mV
V_{IHCMR}	Input HIGH Voltage Common Mode Range (Differential Configuration) (Note 4)	1.2		2.5	1.2		2.5	1.2		2.5	V
R_T	Internal Termination Resistor	43		57	43	50	57	43		57	Ω
I_{IH}	Input HIGH Current			150			150			150	μA
I_{IL}	Input LOW Current			150			150			150	μA
	CLK	-150		150	-150		150	-150		150	μA
	CLK	-150		150	-150		150	-150		150	μA

NOTE: Device will meet the specifications after thermal equilibrium has been established when mounted in a test socket or printed circuit board with maintained transverse airflow greater than 500 lpm.

- Input and output parameters vary 1:1 with V_{CC} .
- All loading with 100 Ω across LVDS differential outputs.
- V_{IHCMR} min varies 1:1 with V_{EE} . V_{IHCMR} max varies 1:1 with V_{CC} . The V_{IHCMR} range is referenced to the most positive side of the differential input signal.

Table 5. AC CHARACTERISTICS $V_{CC} = 2.375$ to 2.625 V , $V_{EE} = 0\text{ V}$ (Note 5)

Symbol	Characteristic	-40°C			25°C			85°C			Unit
		Min	Typ	Max	Min	Typ	Max	Min	Typ	Max	
$f_{\text{maxLVDS/LVPECL}}$	Maximum Frequency (See Figure 2. $F_{\text{max/JITTER}}$)		> 1			> 1			> 1		GHz
t_{PLH} t_{PHL}	Propagation Delay	425	525	625	450	550	650	475	575	675	ps
t_{skew}	Within-Device Skew (Note 6) Device-to-Device Skew (Note 7) Duty Cycle Skew (Note 8)		20 85 80	25 160 100		20 85 80	25 160 100		20 85 80	35 160 100	ps
t_{JITTER}	RMS Random Clock Jitter		0.2	< 1		0.2	< 1		0.2	< 1	ps
V_{PP}	Minimum Input Swing	150	800	1200	150	800	1200	150	800	1200	mV
t_r/t_f	Output Rise/Fall Time (20%–80%)	50	130	200	75	150	225	80	160	230	ps

NOTE: Device will meet the specifications after thermal equilibrium has been established when mounted in a test socket or printed circuit board with maintained transverse airflow greater than 500 lpm.

- Measured with 400 mV source, 50% duty cycle clock source. All loading with 100 Ω across differential outputs.
- Skew is measured between outputs under identical transitions of similar paths through a device.
- Device-to-Device skew for identical transitions at identical V_{CC} levels.
- Duty cycle skew guaranteed only for differential operation measured from the cross point of the input to the cross point of the output.

MC100EP210S

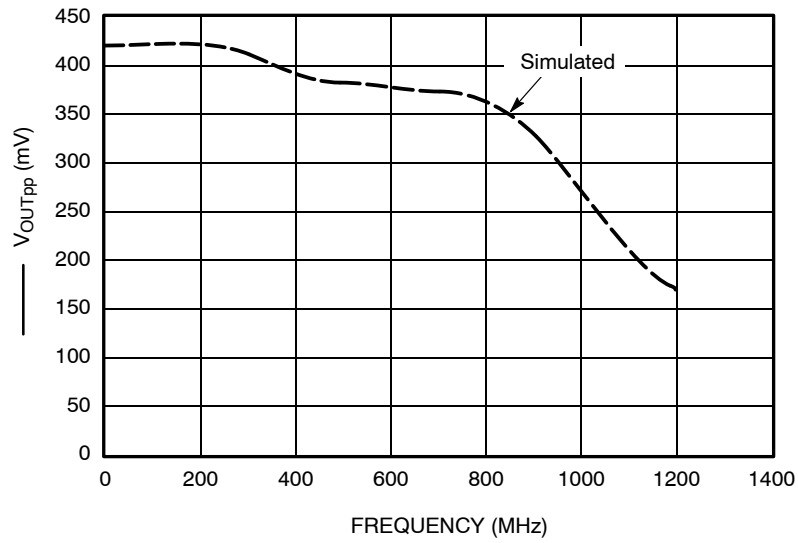

Figure 2. F_{max}

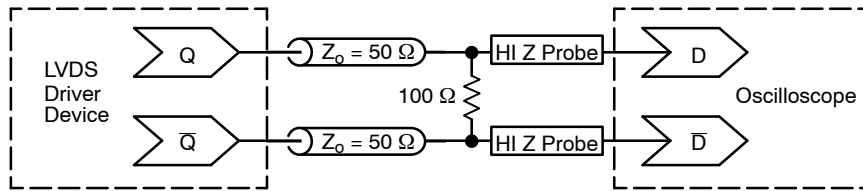

Figure 3. Typical Termination for Output Driver and Device Evaluation

MC100EP210S

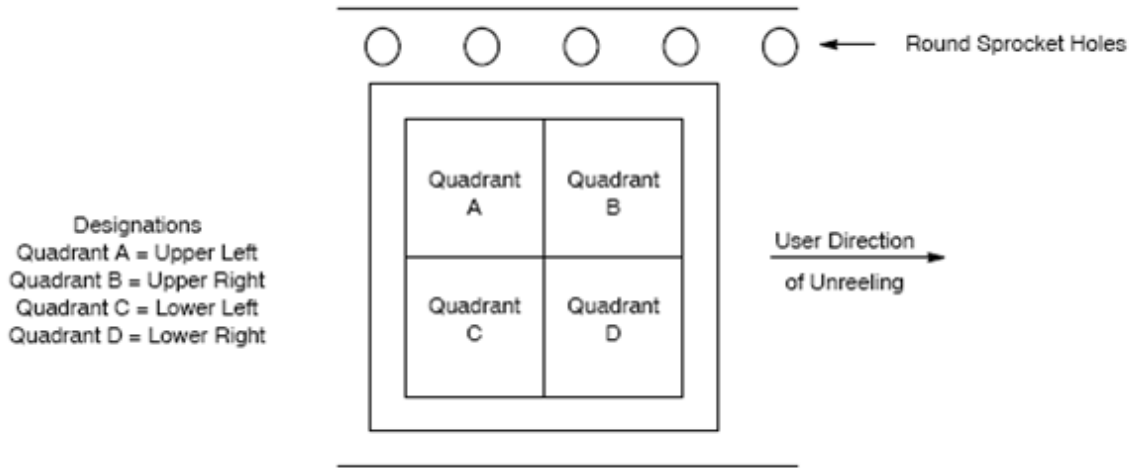
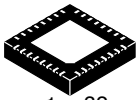

Figure 4. Tape and Reel Pin 1 Quadrant Orientation

ORDERING INFORMATION

Device	Package	Shipping [†]
MC100EP210SFAG	LQFP-32 (Pb-Free)	250 Units / Tray
MC100EP210SFAR2G	LQFP-32 (Pb-Free)	2000 / Tape & Reel (Pin 1 Orientation in Quadrant B, Figure 4)
MC100EP210SMNG	QFN-32 (Pb-Free)	72 Units / Tray
MC100EP210SMNR4G	QFN-32 (Pb-Free)	1000 / Tape & Reel

[†]For information on tape and reel specifications, including part orientation and tape sizes, please refer to our Tape and Reel Packaging Specifications Brochure, [BRD8011/D](#).



1 32
SCALE 2:1

QFN32 5x5, 0.5P
CASE 488AM
ISSUE A

DATE 23 OCT 2013

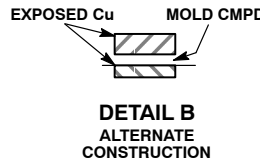
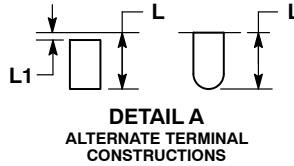
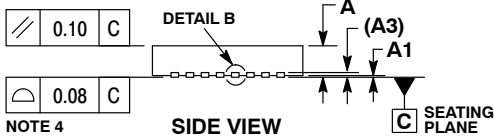
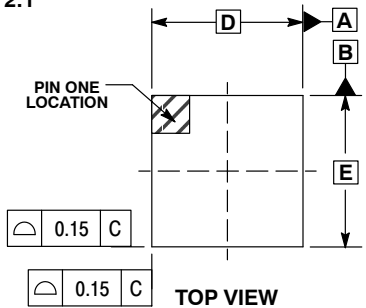

NOTES:

1. DIMENSIONS AND TOLERANCING PER ASME Y14.5M, 1994.
2. CONTROLLING DIMENSION: MILLIMETERS.
3. DIMENSION b APPLIES TO PLATED TERMINAL AND IS MEASURED BETWEEN 0.15 AND 0.30MM FROM THE TERMINAL TIP.
4. COPLANARITY APPLIES TO THE EXPOSED PAD AS WELL AS THE TERMINALS.

MILLIMETERS		
DIM	MIN	MAX
A	0.80	1.00
A1	---	0.05
A3	0.20	REF
b	0.18	0.30
D	5.00	BSC
D2	2.95	3.25
E	5.00	BSC
E2	2.95	3.25
e	0.50	BSC
K	0.20	---
L	0.30	0.50
L1	---	0.15

GENERIC MARKING DIAGRAM*

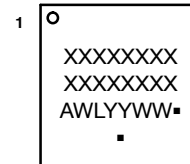

- XXXXX = Specific Device Code
- A = Assembly Location
- WL = Wafer Lot
- YY = Year
- WW = Work Week
- = Pb-Free Package

(Note: Microdot may be in either location)
*This information is generic. Please refer to device data sheet for actual part marking.
Pb-Free indicator, "G" or microdot "▪", may or may not be present.

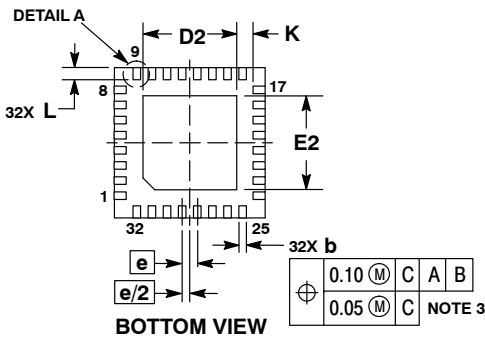

RECOMMENDED SOLDERING FOOTPRINT*

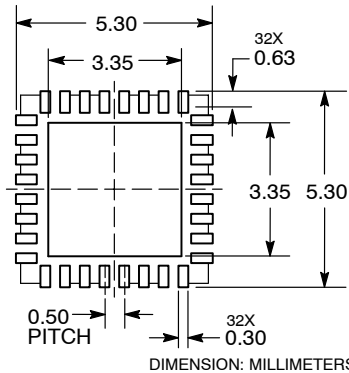

*For additional information on our Pb-Free strategy and soldering details, please download the ON Semiconductor Soldering and Mounting Techniques Reference Manual, SOLDERRM/D.

DOCUMENT NUMBER:	98AON20032D	Electronic versions are uncontrolled except when accessed directly from the Document Repository. Printed versions are uncontrolled except when stamped "CONTROLLED COPY" in red.
DESCRIPTION:	QFN32 5x5 0.5P	PAGE 1 OF 1

onsemi and Onsemi are trademarks of Semiconductor Components Industries, LLC dba onsemi or its subsidiaries in the United States and/or other countries. onsemi reserves the right to make changes without further notice to any products herein. onsemi makes no warranty, representation or guarantee regarding the suitability of its products for any particular purpose, nor does onsemi assume any liability arising out of the application or use of any product or circuit, and specifically disclaims any and all liability, including without limitation special, consequential or incidental damages. onsemi does not convey any license under its patent rights nor the rights of others.

LQFP-32, 7x7
CASE 561AB
ISSUE O

DATE 19 JUN 2008

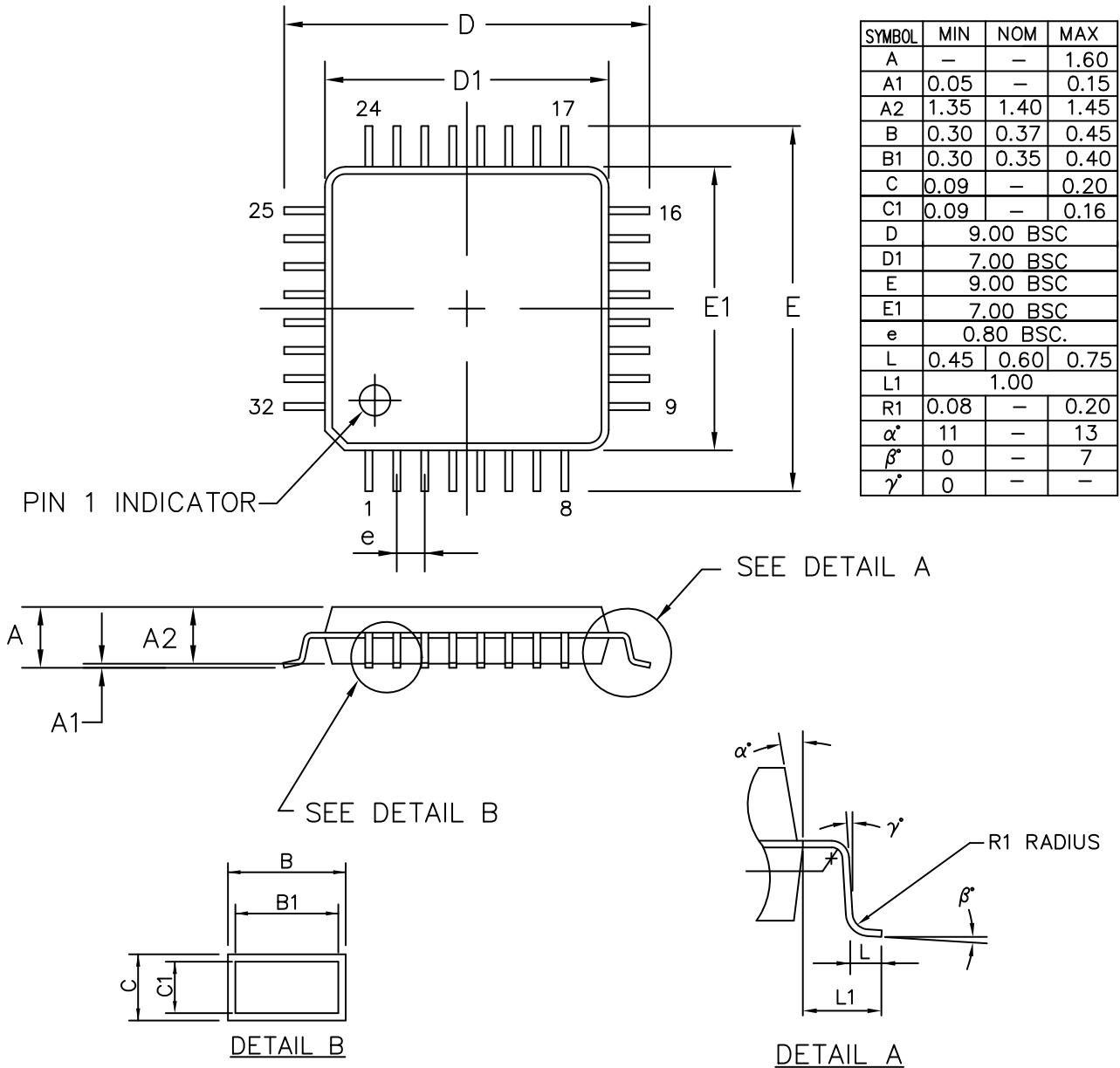

ALL DIMENSIONS IN MM

DOCUMENT NUMBER:	98AON30893E	Electronic versions are uncontrolled except when accessed directly from the Document Repository. Printed versions are uncontrolled except when stamped "CONTROLLED COPY" in red.
DESCRIPTION:	32 LEAD LQFP, 7X7	PAGE 1 OF 1

onsemi and ONSEMI are trademarks of Semiconductor Components Industries, LLC dba onsemi or its subsidiaries in the United States and/or other countries. onsemi reserves the right to make changes without further notice to any products herein. onsemi makes no warranty, representation or guarantee regarding the suitability of its products for any particular purpose, nor does onsemi assume any liability arising out of the application or use of any product or circuit, and specifically disclaims any and all liability, including without limitation special, consequential or incidental damages. onsemi does not convey any license under its patent rights nor the rights of others.

onsemi, **Onsemi**, and other names, marks, and brands are registered and/or common law trademarks of Semiconductor Components Industries, LLC dba "**onsemi**" or its affiliates and/or subsidiaries in the United States and/or other countries. **onsemi** owns the rights to a number of patents, trademarks, copyrights, trade secrets, and other intellectual property. A listing of **onsemi**'s product/patent coverage may be accessed at www.onsemi.com/site/pdf/Patent-Marking.pdf. **onsemi** reserves the right to make changes at any time to any products or information herein, without notice. The information herein is provided "as-is" and **onsemi** makes no warranty, representation or guarantee regarding the accuracy of the information, product features, availability, functionality, or suitability of its products for any particular purpose, nor does **onsemi** assume any liability arising out of the application or use of any product or circuit, and specifically disclaims any and all liability, including without limitation special, consequential or incidental damages. Buyer is responsible for its products and applications using **onsemi** products, including compliance with all laws, regulations and safety requirements or standards, regardless of any support or applications information provided by **onsemi**. "Typical" parameters which may be provided in **onsemi** data sheets and/or specifications can and do vary in different applications and actual performance may vary over time. All operating parameters, including "Typicals" must be validated for each customer application by customer's technical experts. **onsemi** does not convey any license under any of its intellectual property rights nor the rights of others. **onsemi** products are not designed, intended, or authorized for use as a critical component in life support systems or any FDA Class 3 medical devices or medical devices with a same or similar classification in a foreign jurisdiction or any devices intended for implantation in the human body. Should Buyer purchase or use **onsemi** products for any such unintended or unauthorized application, Buyer shall indemnify and hold **onsemi** and its officers, employees, subsidiaries, affiliates, and distributors harmless against all claims, costs, damages, and expenses, and reasonable attorney fees arising out of, directly or indirectly, any claim of personal injury or death associated with such unintended or unauthorized use, even if such claim alleges that **onsemi** was negligent regarding the design or manufacture of the part. **onsemi** is an Equal Opportunity/Affirmative Action Employer. This literature is subject to all applicable copyright laws and is not for resale in any manner.

ADDITIONAL INFORMATION

TECHNICAL PUBLICATIONS:

Technical Library: www.onsemi.com/design/resources/technical-documentation
onsemi Website: www.onsemi.com

ONLINE SUPPORT: www.onsemi.com/support

For additional information, please contact your local Sales Representative at www.onsemi.com/support/sales