

PC VISION SYSTEM - FJ SERIES

Create your ideal system



- » Seamless hardware & software integration
- » Easy customisation
- » Cutting-edge algorithms

Fast machine integration... ...easy customisation

The new customisable FJ Series Vision System combines the benefits of a compact system with the power and flexibility of an industrial PC platform.

The system will enable you to develop your ideal machine vision solution quickly, no matter if you are creating a completely new application or modifying an existing one. Easy HMI creation, unique flexibility and fast integration define this new class of vision system. The FJ Series is available with a range of controllers and cameras, suitable for every application. This eliminates the time needed to integrate components and delivers a platform with the highest quality and reliability.

Features

Quick customisation:

- Fast drag and drop programming
- Choice of ready-made GUIs
- Using existing software

Seamless integration:

- Proven component compatibility
- Wide selection of intelligent cameras

Stable, high-speed processing:

- Advanced algorithms
- HDD-less controllers



Development environment Application Producer



Windows embedded-based FJ Controller



One complete and compatible collection of all the components you need to build your ideal machine vision system.

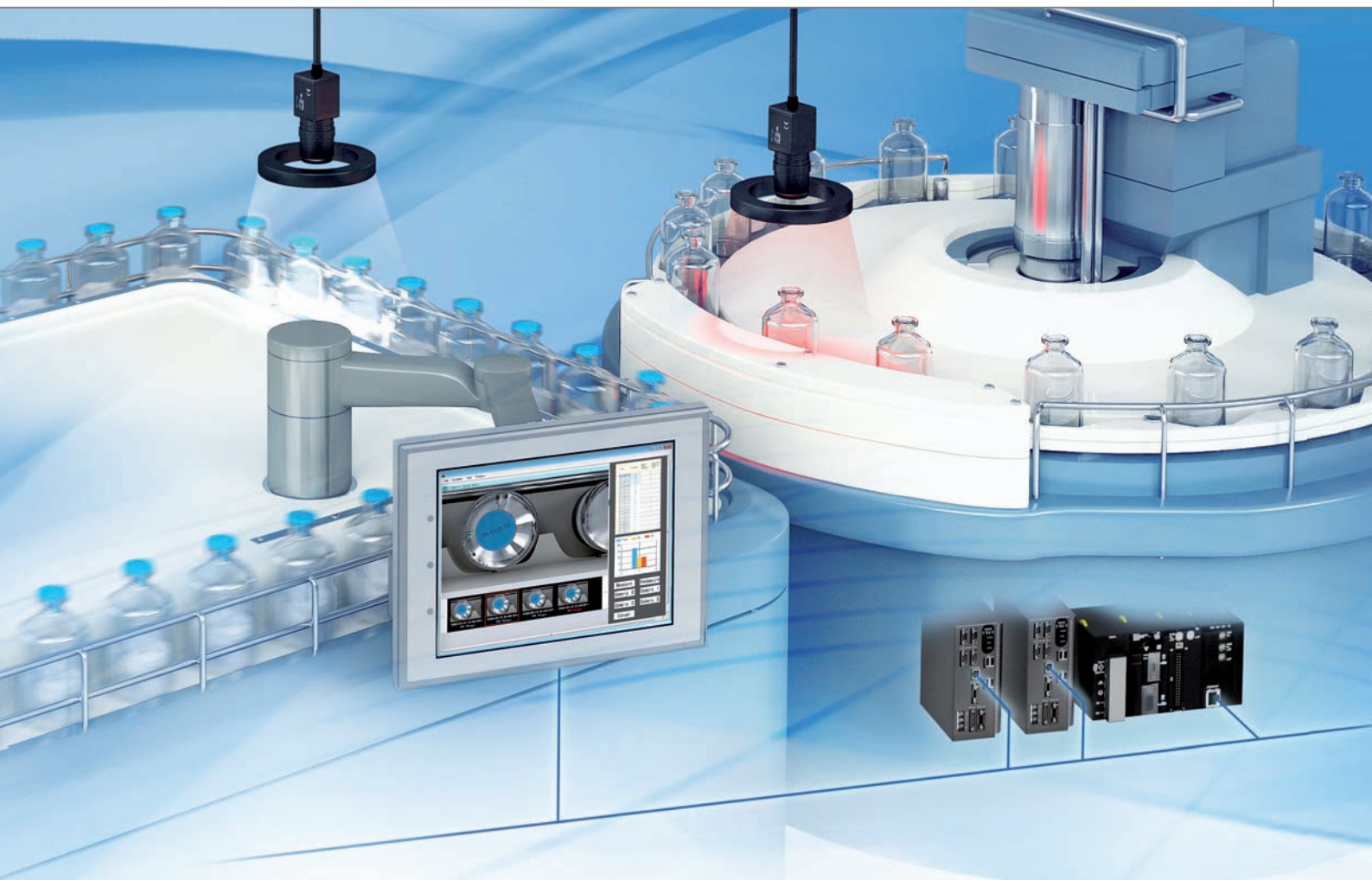

Highly flexible development

Imagine how much money you could save by reducing your current development time by 50%. With the FJ Series you can do just that. That's because you can build processing flow simply by listing the processing items for each measurement. Other features that accelerate development include: sample GUIs, options to re-use existing software, built-in touchscreens, and more.



Proven reliability

All the hardware and software components are completely compatible. In addition, the controllers use flash memory – not hard disc drives – so they always remain highly reliable even in a hostile factory environment.



Stable and high-speed inspection

The Halcon library of algorithms provides high-speed processing and measurement. In addition, the FJ Series' High Dynamic Range and Real Colour sensing techniques ensure robust and stable operation.

Smart programming

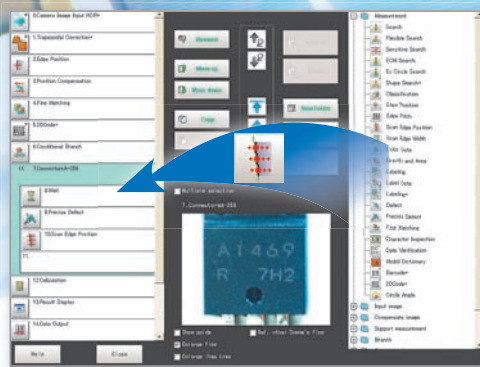

Drag and drop with image processing

You can create new measurement and inspection flows quickly and easily with our ready-made modules. Simply choose from the 60+ modules and drag and drop them to define your required image-input, measurement and other sequences – as well as building your processing flows. No more searching subroutine libraries and painstakingly piecing them together. You can immediately create new inspection functions from our ready-made software modules.

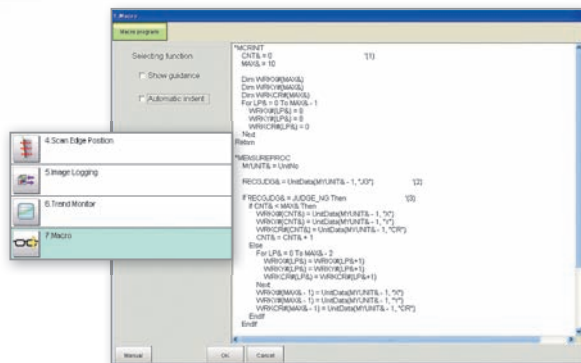

We also offer a wide range of Macros to further accelerate your development process – especially for your calculation functions. Simply drag and drop the required Macro into your flow.

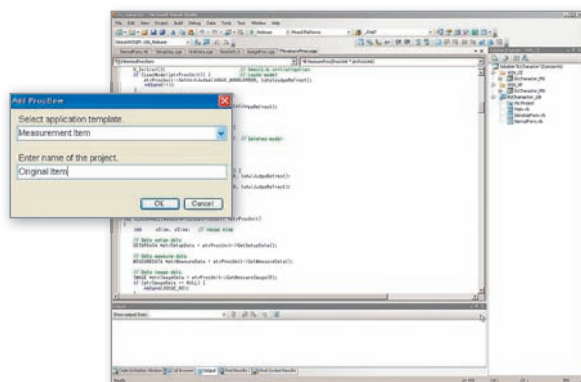

Own developed algorithms

If the item you need is not included in the new FJ Series software suite, you can easily create your own item using Microsoft® Visual Studio® and the “Application Producer”. The Development Wizard and code samples ensure that creating programs, including those for your GUI, is always quick and simple.

Easy HMI configuration

Show only the buttons you need

Choose from our library of buttons and position them anywhere on-screen to best support your daily operation, without 'screen clutter'.

Add a camera image

With just one click.

Eight screen layout

Up to 8 screens can be stored depending on the application or user classification.

Move windows freely

Drag and drop windows where you want. You can also change the box size and delete.

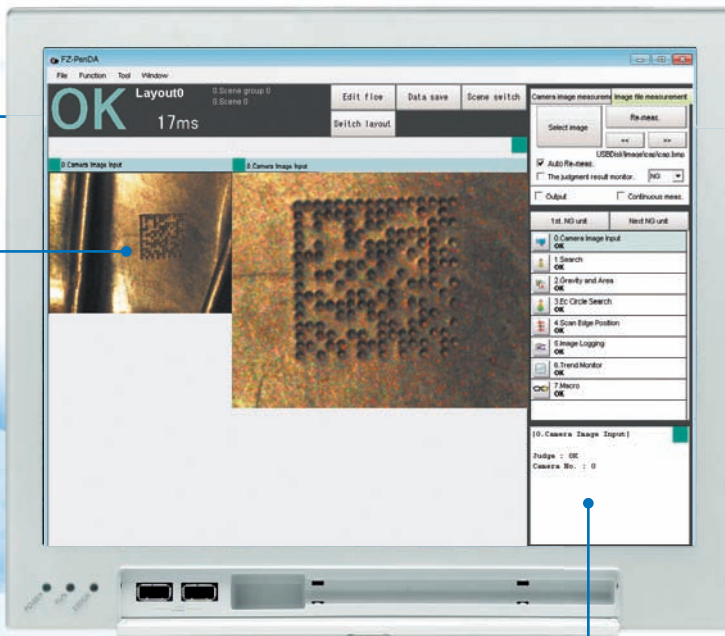

Free HMI programming

Create the HMI to fit your needs

You can create original HMI and GUIs quickly with Visual Studio®, rich customisable control units and program samples in the FJ "Application Producer".

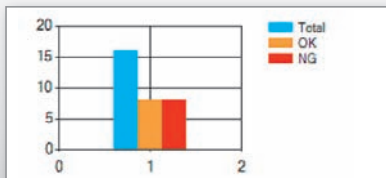

Program sample for bar graph

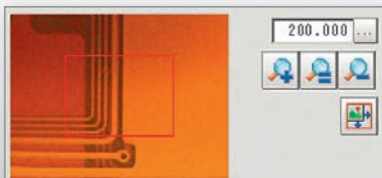

Zoom browser

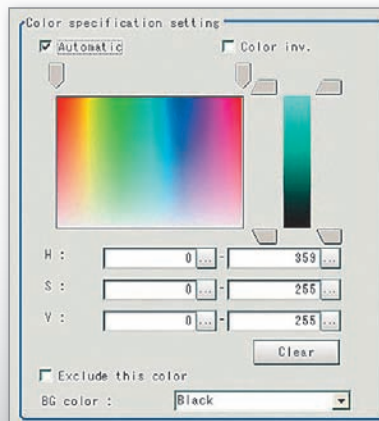

Colour setting control

Seamless connectivity with your machine

Working in perfect harmony with your machine

The FJ Series controllers are Windows-based Open IPCs on which you can install your regular PC programs. You can also install printer and robot controller driver software.

The Windows-based environment in the FJ Series allows you to reuse your existing software which supports the building of your machine's vision application such as statistical, communication, printer driver and other software. This not only saves time but enables you to continue benefitting from previous investments.



Remote monitoring and control

The FJ Series is Ethernet-compatible. This enables you to remotely monitor your systems when in use at your customer's sites and therefore enables you to schedule timely maintenance programs and ensure continued customer satisfaction.



Factory



Office

Build in security - more customer satisfaction

You can further delight your customers by building in security functions that prevent operational errors on the shop floor. Simply choose from the sample, ready-made code in the "Application Producer".

Access control operation

Running screen

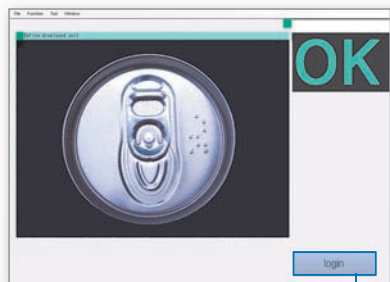

Measurement result clearly displayed

Administrative screen

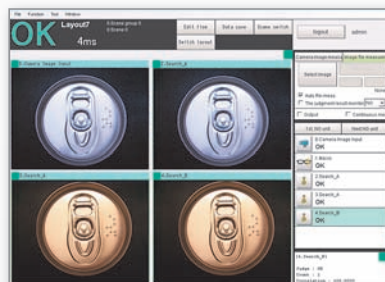

Tuning menu

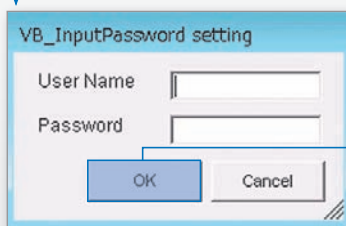

Easy implementation

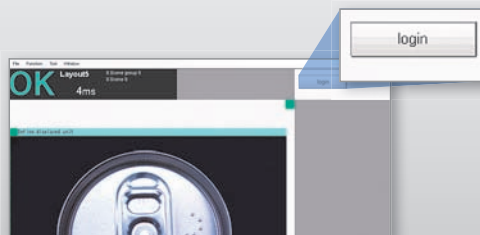
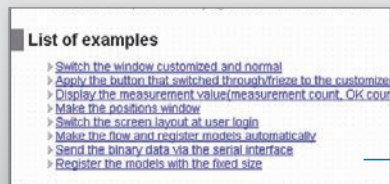

1. Select from the sample list in the "Application Producer"

2. Drag and Drop the zip file

3. The login button is automatically created

Always keeping you up to date with the latest software

You can get free downloads of the latest versions of software, sample programs, and new technical documentation any time after purchasing the FJ Series. With Omron, you will always have access to the latest systems and knowledge.

http://www.omron-cxone.com/pc_v/index.html



Stable, high-speed inspection via superior image processing...



HDR sensing

With our High Dynamic Range* sensing technology, changing lighting levels will never affect the performance of your system, making it extremely stable. HDR sensing also avoids the need for complex illumination schemes, the FJ Series Vision System is highly stable and performs at high speed in normal lighting levels. Also with an HDR of up to 5000:1 your vision system will also inspect shiny, reflective surfaces with extreme accuracy and without halation.



Real Colour Sensing

The limitations of traditional vision systems have also been overcome in the FJ Series by using 24-bit Real Colour sensing to better mimic the colours found in the real world. Real Colour sensing instantly recognises more than 16 million different colours in real-time using 256 shades of red, 256 shades of blue, and 256 shades of green. This translates into faster inspections without sacrificing quality, performance, or resolution.

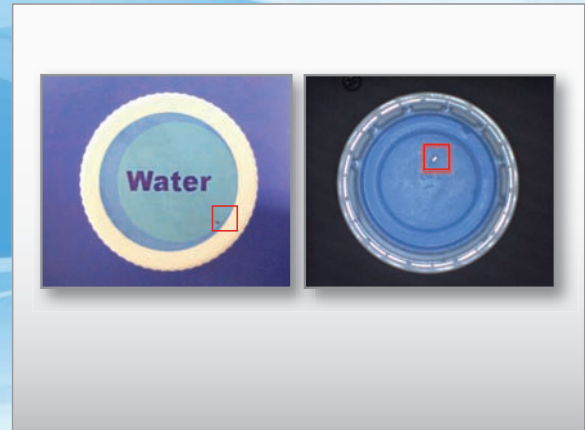
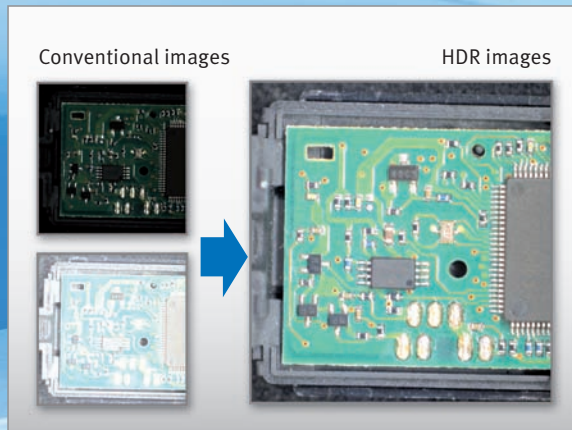

* The “dynamic range” of an imaging system refers to its ability to detect differences in luminosity. The higher the dynamic range, the clearer the images.

Inspection and Measurement Items



Search



Flexible Search



Sensitive Search



ECM Search



EC Circle Search



Sharpe Search+



Classification



Edge Position



Edge Pitch



Scan Edge Position



Scan Edge Width

...and advanced algorithms



More than 1600 algorithms

Take advantage of the HALCON Algorithm vision library: more than 1600 state-of-the-art algorithms specially made for high-speed inspection systems. Combine these with Omron's wide range of GUIs to create your ideal processing items. This also allows you to easily build an interface to turn HALCON Algorithms into useful processing items on the shop floor.



Shape-based matching

Even under difficult conditions, such as missing workpieces or foreign objects on the line, the FJ Series still conducts robust measurements and inspections.

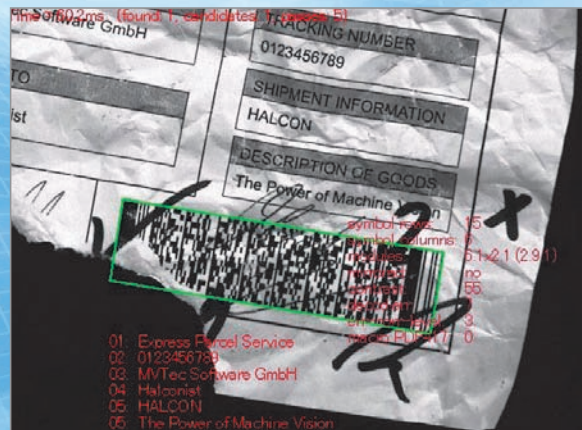

High-speed, stable code reading

Even scratched or dirty codes can be read with extreme accuracy. Codes printed onto materials with varying reflectivity, such as metals, PCBs, and glass can also be read with excellent accuracy.



Colour Data



Gravity and Area



Labelling



Defect



Precise Defect



Fine Matching



Character Inspection



Date Verification



Barcode+



2DCode+



Circle Angle

Highly reliable hardware

guaranteed connectivity

All the different components in the FJ Series – cameras, controllers, frame grabbers, light sources, and software – are proven to be 100% compatible. So you can choose the exact components you want, with the exact performance levels you need, and be confident that it will all come together perfectly.



Highly robust controllers

The FJ Series controllers use Flash memory – not hard disc drives. That's why they are highly robust and can take a few knocks in the factory environment. Even sudden power outages and strong vibration will not affect them. Choose either the compact controller when space is limited, or the touchscreen-integrated model for optimised ease of use.



Controller BOX-type

Controller integrated with LCD

Ladder programs made easy

A PLC Link function is included to reduce the time and effort spent on ladder programming for serial communications and standard Ethernet.



Applicable PLCs

- Omron CS, CJ, CP, and NSJ Series
- Mitsubishi Electric Q Series



Wide range of cameras

You have a choice of 20 different digital cameras, including intelligent models which can automatically adjust their shutter speeds to compensate for changing lighting levels. There is also a choice of compact intelligent cameras for when space is limited.

Choice of lighting

Lighting timing and lighting power are managed by the FJ Series controller. When several cameras are connected to one controller, the flash timings are controlled automatically to prevent interference.

SEAMLESS CONNECTIVITY

Open Network

Ethernet/IP, a global standard for factory automation data networking, is supported or seamlessly integrated into a production line or machine. This allows users to easily connect to any manufacturer. Further communication is possible via TCP/IP, serial and parallel interfaces



System Configuration

Standard Configuration

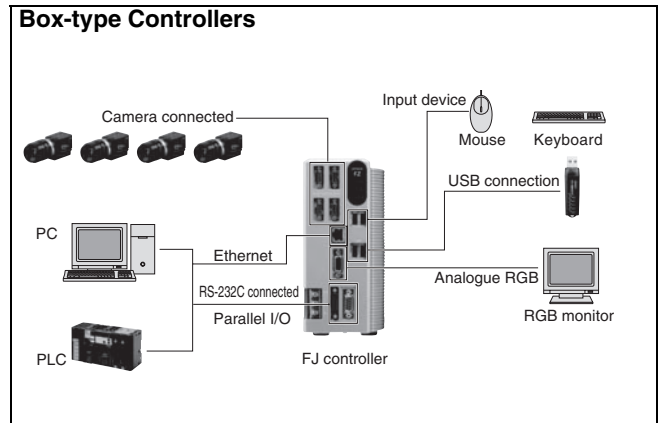
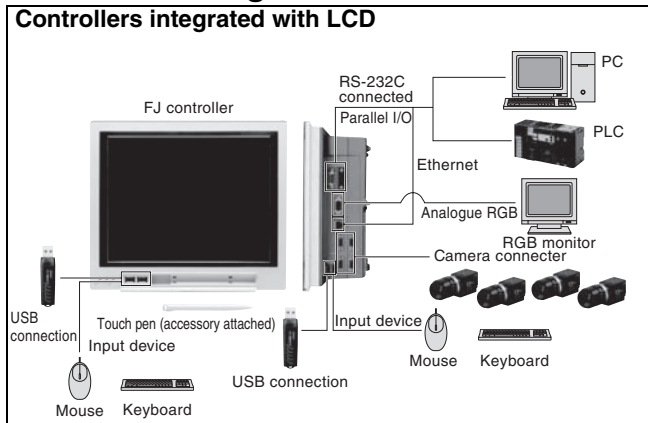

For Customization

Development environment Application Producer



Sample codes and Development Wizard for easy customization are available.

Ordering Information

Controller

CPU	Type	Dual-task	HALCON installed (See note)	No. of Cameras	Output	Model
Core i5 2.4 GHz	Controller integrated with LCD	Yes	No	2	NPN	FJ-3000
		Yes	No	4	NPN	FJ-3000-10
		Yes	No	2	PNP	FJ-3005
		Yes	No	4	PNP	FJ-3005-10
		Yes	Yes	2	NPN	FJ-H3000
		Yes	Yes	4	NPN	FJ-H3000-10
		Yes	Yes	2	PNP	FJ-H3005
	Box-type Controller	Yes	No	2	NPN	FJ-3050
		Yes	No	4	NPN	FJ-3050-10
		Yes	No	2	PNP	FJ-3055
		Yes	No	4	PNP	FJ-3055-10
		Yes	Yes	2	NPN	FJ-H3050
		Yes	Yes	4	NPN	FJ-H3050-10
		Yes	Yes	2	PNP	FJ-H3055
Atom 1.6 GHz	Box-type Controller	Yes	Yes	4	PNP	FJ-H3055-10
		No	No	2	NPN	FJ-350
		No	No	4	NPN	FJ-350-10
		No	No	2	PNP	FJ-355
		No	No	4	PNP	FJ-355-10

Note: HALCON runtime license has been installed. The development of HALCON requires HDevelop.

Development environment

Type	Model	Operating environment
Application Producer	FJ-AP1	<ul style="list-style-type: none"> CPU: Intel Pentium Processor (SSE2 or higher) OS: Windows XP Professional (32bit) Service pack 3 or later, or Windows 7 Professional (32bit) or Enterprise (32bit) or Ultimate (32bit) .NET Framework: .NET Framework 3.5 or higher Memory: At least 2 GB RAM Available disk space: At least 2 GB Browser: Microsoft® Internet Explorer 6.0 or later Display: XGA (1024×768), True Color (32-bit) or higher Optical drive: CD/DVD drive The following software is required to customize the software: Microsoft® Visual Studio® 2010 Professional

Cameras

Type	Model	Remarks	
Digital Cameras	300,000 pixels	Color	FZ-SC
		Monochrome	FZ-S
	2 million pixels	Color	FZ-SC2M
		Monochrome	FZ-S2M
	5 million pixels	Color	FZ-SC5M2
		Monochrome	FZ-S5M2

Lens required

Type		Model		Remarks
Small Digital Cameras	300,000-pixel flat type	Color	FZ-SFC	Lens for small cameras required
		Monochrome	FZ-SF	
	300,000-pixel pen type	Color	FZ-SPC	
		Monochrome	FZ-SP	
High-speed Cameras	300,000 pixels	Color	FZ-SHC	Lens required
		Monochrome	FZ-SH	
Intelligent Compact Cameras	Wide View (Long-distance)	Color	FZ-SQ100F	Camera + Lens + High-power Lighting
	Wide View (Short-distance)	Color	FZ-SQ100N	
	Standard	Color	FZ-SQ050F	
	Narrow View	Color	FZ-SQ010F	
Intelligent Cameras	Wide field of vision	Color	FZ-SLC100	Camera + Zoom, Autofocus Lens + Intelligent Lighting
	Narrow field of vision	Color	FZ-SLC15	
Autofocus Cameras	Wide field of vision	Color	FZ-SZC100	Camera + Zoom, Autofocus Lens
	Narrow field of vision	Color	FZ-SZC15	

Cameras peripheral devices

Type		Model		Remarks
CCTV Lenses		3Z4S-LE Series		—
Extension Tubes				
Low-distortion Lenses		FZ-LEH5/LEH8/LEH12/LEH16/LEH25/LEH35/LEH50/LEH75/LEH100		Low distortion lens for 2-million and 5-million Pixel Cameras
Lenses for Small Camera		FZ-LES3/LES6/LES16/LES30		Lens for 300,000-pixel Small Cameras
Extension Tubes for Small Camera		FZ-LESR		Extension Tubes for 300,000-pixel Small Cameras
Intelligent Camera Diffusion Plate	Wide field of vision	FZ-SLC100-DL		—
	Narrow field of vision	FZ-SLC15-DL		
Halation cut illumination			FZ-SXCRB7018BR-4S	Integrated unit combining special Halation cut illumination, strobe controller and camera (without lens)
			FZ-LTCRB7018BR-4S	Integrated unit combining special Halation cut illumination and strobe controller
			FZ-LTRB7018BR-4S	Special Halation cut illumination only
For Intelligent Compact Camera	Mounting brackets	FQ-XL/XL2		—
	Polarizing Filter Attachment	FQ-XF1		

Cables

Type	Cable length:	Model	Remarks
Camera Cable	2 m, 5 m, 10 m (See note 2)	FZ-VS	—
Bend resistant Camera Cables	2 m, 5 m, 10 m (See note 3)	FZ-VSB	
Right-angle Camera Cable (See note 1)	2 m, 5 m, 10 m (See note 2)	FZ-VSL	
Long-distance Camera Cable	15 m (See note 4)	FZ-VS2	
Long-distance Right-angle Camera Cable	15 m (See note 4)	FZ-VSL2	
Cable Extension Unit	Maximum cable length: 45 m (Up to two Extension Units and three Cables can be connected.) (See note 5)	FZ-VSJ	
Monitor Cable	2 m, 5 m	FZ-VM	
Parallel Cable	2 m, 5 m	FZ-VP	
	2 m, 5 m, Connector-type	FZ-VPX (See note 6)	

- Note:**
- This Cable has an L-shaped connector on the Camera end.
 - The 10-m Cable cannot be used for the Intelligent Camera, Autofocus Camera and 5-million pixel camera.
 - The 10-m Cable cannot be used for the Intelligent Camera, Autofocus Camera, 2-million pixel camera and 5-million pixel camera.
 - The 15-m Cable cannot be used for the Intelligent Camera, Autofocus Camera and 5-million pixel camera.
 - Maximum cable length depends on type of camera and cable length to connect. For details, refer to "Cameras / Cables Connection Table".
 - Connector-Terminal Block Conversion Units can be connected (Recommended Products: OMRON XW2B-50G4/50G5, XE2D-50G6).

Peripheral devices

Type		Model		Remarks
LCD Monitor		FZ-M08		For box-type controller
USB Memory		FZ-MEM1G		Capacity: 1 GB
VESA attachment		FZ-VESA		For installing the controller integrated with LCD
Desktop controller stand		FZ-DS		For installing the controller integrated with LCD
Lighting Controller	For FL-Series		FL-TCC1	Required to control external lighting from a Controller
	For 3Z4S-LT Series	One channel	Manufactured by MORITEX Corporation 3Z4S-LT MLEK-C100E1TS2	
		Two channels	FZ-LTA100	
Strobe Controller	For FZ-LT Series		FZ-LTA200	
	Adapter for the strobe controller		Manufactured by MORITEX Corporation 3Z4S-LT LBK-003	Required to mount a strobe controller on a 5-million pixel camera when using 3Z4S-LT series
External Lighting			3Z4S-LT Series	—
			FZ-LT Series	
			FL-Series	

Cameras / Cables Connection Table

Type of camera	Model	Cable length	Intelligent cameras Autofocus cameras	High-speed cameras	Digital cameras			Small digital cameras Pen type / flat type	Intelligent compact cameras
					300,000-pixel	2 million-pixel	5 million-pixel		
Camera Cables Right-angle camera cables	FZ-VS FZ-VSL	2m	Yes	Yes	Yes	Yes	Yes	Yes	Yes
		5m	Yes	Yes	Yes	Yes	Yes	Yes	Yes
		10m	No	Yes	Yes	Yes	No	Yes	Yes
Bend resistant camera cables	FZ-VSB	2m	Yes	Yes	Yes	Yes	Yes	Yes	Yes
		5m	Yes	Yes	Yes	Yes	Yes	Yes	Yes
		10m	No	Yes	Yes	Yes	No	Yes	Yes
Long-distance camera cable Long-distance right-angle camera cable	FZ-VS2 FZ-VSL2	15m	No	Yes	Yes	Yes	No	Yes	Yes

Ratings and Performance

Controller

Model		NPN Output	FJ-3000	FJ-3000-10	FJ-3050	FJ-3050-10	FJ-H3000	FJ-H3000-10	FJ-H3050	FJ-H3050-10	FJ-350	FJ-350-10	
		PNP Output	FJ-3005	FJ-3005-10	FJ-3055	FJ-3055-10	FJ-H3005	FJ-H3005-10	FJ-H3055	FJ-H3055-10	FJ-355	FJ-355-10	
Controller type		Controller integrated with LCD			Box-type controller		Controller integrated with LCD		Box-type controller		Box-type controller		
No. of cameras		2	4	2	4	2	4	2	4	2	4		
CPU		Intel Core i5-520E Processor 2.40 GHz									Intel Atom N270 Processor 1.6 GHz		
Main memory		3 GB									2 GB		
Storage		Compact Flash 2 GB											
OS		Windows Embedded Standard 2009											
Dual-task		Yes									No		
HALCON installed		No						Yes			No		
Connected camera		Can be connected to all cameras.											
Operation		Controller integrated with LCD: touch pen, mouse, etc. Box-type controller: mouse, etc.											
Processing resolution		Intelligent Compact Camera: 752 (H) × 480 (V) 300,000-pixel camera: 640 (H) × 480 (V) 2-million pixel camera: 1600 (H) × 1200 (V), 5-million pixel camera: 2488 (H) × 2044 (V)											
No. of scenes		32											
Number of logged images	When connected to an Intelligent Compact Camera	Connected to 1 camera	214										
		Connected to 2 cameras	107										
		Connected to 3 cameras	71										
		Connected to 4 cameras	53										
	When connected to a 300,000-pixel camera	Connected to 1 camera	Color camera: 250, Monochrome Camera: 252										
		Connected to 2 cameras	Color camera: 125, Monochrome Camera: 126										
		Connected to 3 cameras	Color camera: 83, Monochrome Camera: 84										
		Connected to 4 cameras	Color camera: 62, Monochrome Camera: 63										
	When connected to a 2 million-pixel camera	Connected to 1 camera	Color camera: 40, Monochrome Camera: 40										
		Connected to 2 cameras	Color camera: 20, Monochrome Camera: 20										
		Connected to 3 cameras	Color camera: 13, Monochrome Camera: 13										
		Connected to 4 cameras	Color camera: 10, Monochrome Camera: 10										
	When connected to a 5 million-pixel camera	Connected to 1 camera	Color camera: 15, Monochrome Camera: 15										
		Connected to 2 cameras	Color camera: 7, Monochrome Camera: 7										
		Connected to 3 cameras	Color camera: 5, Monochrome Camera: 5										
		Connected to 4 cameras	Color camera: 3, Monochrome Camera: 3										
Serial communications		RS-232C/422A: 1CH									RS-232C: 1CH		
Network communications		Ethernet 100BASE-TX/10BASE-T									Ethernet 1000BASE-T/100BASE-TX/10BASE-T		
EtherNet/IP		Ethernet port baud rate: 100 Mbps (100BASE-TX)											
Parallel I/O		17 inputs (RESET, STEP0/ENCTRIG_Z0, STEP1/ENCTRIG_Z1, DSA0 to 1, ENCTRIG_A0 to 1, ENCTRIG_B0 to 1, DIO to 7) 29 outputs (RUN/BUSY1, BUSY0, GATE0 to 1, OR0 to 1, READY0 to 1, ERROR, STGOUT0 to 3*, DO0 to 15)									11 inputs (RESET, STEP, DSA, DIO to 7) 26 outputs (RUN, BUSY, GATE, OR, READY, ERROR, STGOUT0 to 3*, DO0 to 15)		
Monitor interface		Controller integrated with LCD: integrated controller and LCD 12.1 inch TFT color LCD (Resolution: XGA 1,024 × 768 dots) Box-type controller: Analog RGB video output, 1 channel (Resolution: XGA 1,024 × 768 dots)											
USB interface		4 channels (supports USB 1.1 and 2.0)									2 channels (supports USB 1.1 and 2.0)		
Power supply voltage		20.4 to 26.4 VDC											
Current consumption (at 24.0 VDC)	When connected to an Intelligent Compact Camera, intelligent or autofocus camera	5.0 A max.	7.5 A max.	5.0 A max.	7.5 A max.	5.0 A max.	7.5 A max.	5.0 A max.	7.5 A max.	4.0 A max.	5.5 A max.		
	When connected to a 300,000-pixel, 2 million-pixel, or 5 million-pixel camera	3.7 A max.	4.9 A max.	3.7 A max.	4.9 A max.	3.7 A max.	4.9 A max.	3.7 A max.	4.9 A max.	2.6 A max.	2.9 A max.		
Ambient temperature range		Operating: 0 to +45°C for low cooling fan speeds 0 to +50°C for high cooling fan speeds Storage: -20 to 65°C (with no icing or condensation)									Operating: 0 to 50°C Storage: -20 to 65°C (with no icing or condensation)		
Ambient humidity range		Operating and storage: 35 to 85% (with no condensation)											
Weight		Approx. 3.4 kg			Approx. 1.9 kg		Approx. 3.4 kg		Approx. 1.9 kg		Approx. 1.8 kg		
Accessories		Controller integrated with LCD: touch pen (one, inside the front panel), Instruction Manual, 6 mounting brackets, Member registration sheet Box-type controller: Instruction Manual, Member registration sheet											

* STGOUT 2 to 3 only for camera 4ch type

Digital cameras

	FZ-S	FZ-SC	FZ-S2M	FZ-SC2M	FZ-S5M2	FZ-SC5M2
Image elements	Interline transfer reading all pixels, 1/3-inch CCD image elements		Interline transfer reading all pixels, 1/1.8-inch CCD image elements		Interline transfer reading all pixels, 2/3-inch CCD image elements	
Color/Monochrome	Monochrome	Color	Monochrome	Color	Monochrome	Color
Effective pixels	640 (H) × 480 (V)		1600 (H) × 1200 (V)		2448 (H) × 2044 (V)	
Pixel size	7.4 (μm) × 7.4 (μm)		4.4 (μm) × 4.4 (μm)		3.45 (μm) × 3.45 (μm)	
Shutter function	Electronic shutter; select shutter speeds from 1/10 to 1/50,000 s		Electronic shutter; select shutter speeds from 1/10 to 1/50,000 s		Electronic shutter; select shutter speeds from 1/10 to 1/50,000 s	
Partial function	12 to 480 lines		12 to 1200 lines		12 to 2044 lines	
Frame rate (image read time)	80 fps (12.5 ms)		30 fps (33.3 ms)		16 fps (62.5 ms)	
Field of vision, installation distance	Selecting a lens according to the field of vision and installation distance					
Ambient temperature range	Operating: 0 to 50°C Storage: -25 to 65°C (with no icing or condensation)		Operating: 0 to 40°C Storage: -25 to 65°C (with no icing or condensation)		Operating: 0 to 40°C Storage: -25 to 65°C (with no icing or condensation)	
Ambient humidity range	Operating and storage: 35% to 85% (with no condensation)					
Weight	Approx. 55 g		Approx. 76 g		Approx. 140 g	
Accessories	Instruction manual					

Small digital cameras

	FZ-SF	FZ-SFC	FZ-SP	FZ-SPC
Image elements	Interline transfer reading all pixels, 1/3-inch CCD image elements			
Color/Monochrome	Monochrome	Color	Monochrome	Color
Effective pixels	640 (H) × 480 (V)			
Pixel size	7.4 (μm) × 7.4 (μm)			
Shutter function	Electronic shutter; select shutter speeds from 1/10 to 1/50,000 s			
Partial function	12 to 480 lines			
Frame rate (image read time)	80 fps (12.5 ms)			
Field of vision, installation distance	Selecting a lens according to the field of vision and installation distance			
Ambient temperature range	Operating: 0 to 50°C (camera amp) 0 to 45°C (camera head) Storage: -25 to 65°C (with no icing or condensation)		Operating: 0 to 50°C (camera amp) 0 to 45°C (camera head) Storage: -25 to 65°C (with no icing or condensation)	
Ambient humidity range	Operating and storage: 35% to 85% (with no condensation)		Operating and storage: 35% to 85% (with no condensation)	
Weight	Approx. 150 g		Approx. 150 g	
Accessories	Instruction manual, installation bracket, Four mounting brackets(M2)		Instruction manual	

High-speed cameras

	FZ-SH	FZ-SHC
Image elements	Interline transfer reading all pixels, 1/3-inch CCD image elements	
Color/Monochrome	Monochrome	Color
Effective pixels	640 (H) × 480 (V)	
Pixel size	7.4 (μm) × 7.4 (μm)	
Shutter function	Electronic shutter; select shutter speeds from 1/10 to 1/50,000 s	
Partial function	12 to 480 lines	
Frame rate (image read time)	204 fps (4.9 ms)	
Field of vision, installation distance	Selecting a lens according to the field of vision and installation distance	
Ambient temperature range	Operating: 0 to 40°C Storage: -25 to 65°C (with no icing or condensation)	
Ambient humidity range	Operating and storage: 35% to 85% (with no condensation)	
Weight	Approx. 105 g	
Accessories	Instruction manual	

Intelligent compact cameras

	FZ-SQ010F	FZ-SQ050F	FZ-SQ100F	FZ-SQ100N
Image elements	1/3-inch CMOS image elements			
Color/Monochrome	Color			
Effective pixels	752 (H) × 480 (V)			
Pixel size	6.0 (μm) × 6.0 (μm)			
Shutter function	1/250 to 1/32,258			
Partial function	8 to 752 lines			
Frame rate (image read time)	60 fps			
Field of vision	7.5 × 4.7 to 13 × 8.2 mm	13 × 8.2 to 53 × 33 mm	53 × 33 to 240 × 153 mm	29 × 18 to 300 × 191 mm
Installation distance	38 to 60 mm	56 to 215 mm	220 to 970 mm	32 to 380 mm
LED class	Class 2			
Ambient temperature range	Operating: 0 to 50°C Storage: -25 to 65°C			
Ambient humidity range	Operating and storage: 35% to 85% (with no condensation)			
Weight	Approx. 150 g		Approx. 140 g	
Accessories	Mounting bracket (FQ-XL), polarizing filter attachment (FQ-XF1), instruction manual and warning label			

Intelligent cameras, autofocus cameras

	FZ-SLC100	FZ-SLC15	FZ-SZC100	FZ-SZC15
Image elements	Interline transfer reading all pixels, 1/3-inch CCD image elements			
Color/Monochrome	Color			
Effective pixels	640 (H) × 480 (V)			
Pixel size	7.4 (μm) × 7.4 (μm)			
Shutter function	Electronic shutter; select shutter speeds from 1/10 to 1/50,000 s			
Partial function	12 to 480 lines			
Frame rate (image read time)	80 fps (12.5ms)			
Field of vision (See note 2.)	13 to 100 mm (See note1.)	2.9 to 14.9 mm (See note1.)	13 to 100 mm (See note1.)	2.9 to 14.9 mm (See note1.)
Installation distance	70 to 190 mm (See note1.)	35 to 55 mm (See note1.)	77.5 to 197.5 mm (See note1.)	47.5 to 67.5 mm
LED class (See note 3.) (lighting)	Class 2			
Ambient temperature range	Operating: 0 to 50°C Storage: -25 to 65°C (with no icing or condensation)			
Ambient humidity range	Operating and storage: 35% to 85% (with no condensation)			
Weight	Approx. 670 g	Approx. 700 g	Approx. 500 g	
Accessories	Instruction Sheet and hexagonal wrench			

- Note:**
1. Tolerance: ±5% max.
 2. The length of the visual field is the lengths along the Y axis.
 3. Applicable standards: IEC 60825-1: 1993 + A1: 1997 + A2-2001, EN 60825-1: 1994 + A1: 2002 + A2: 2001

READ AND UNDERSTAND THIS DOCUMENT

Please read and understand this document before using the products. Please consult your OMRON representative if you have any questions or comments.

WARRANTY

OMRON's exclusive warranty is that the products are free from defects in materials and workmanship for a period of one year (or other period if specified) from date of sale by OMRON.

OMRON MAKES NO WARRANTY OR REPRESENTATION, EXPRESS OR IMPLIED, REGARDING NON-INFRINGEMENT, MERCHANTABILITY, OR FITNESS FOR PARTICULAR PURPOSE OF THE PRODUCTS. ANY BUYER OR USER ACKNOWLEDGES THAT THE BUYER OR USER ALONE HAS DETERMINED THAT THE PRODUCTS WILL SUITABLY MEET THE REQUIREMENTS OF THEIR INTENDED USE. OMRON DISCLAIMS ALL OTHER WARRANTIES, EXPRESS OR IMPLIED.

LIMITATIONS OF LIABILITY

OMRON SHALL NOT BE RESPONSIBLE FOR SPECIAL, INDIRECT, OR CONSEQUENTIAL DAMAGES, LOSS OF PROFITS OR COMMERCIAL LOSS IN ANY WAY CONNECTED WITH THE PRODUCTS, WHETHER SUCH CLAIM IS BASED ON CONTRACT, WARRANTY, NEGLIGENCE, OR STRICT LIABILITY.

In no event shall responsibility of OMRON for any act exceed the individual price of the product on which liability is asserted.

IN NO EVENT SHALL OMRON BE RESPONSIBLE FOR WARRANTY, REPAIR, OR OTHER CLAIMS REGARDING THE PRODUCTS UNLESS OMRON'S ANALYSIS CONFIRMS THAT THE PRODUCTS WERE PROPERLY HANDLED, STORED, INSTALLED, AND MAINTAINED AND NOT SUBJECT TO CONTAMINATION, ABUSE, MISUSE, OR INAPPROPRIATE MODIFICATION OR REPAIR.

SUITABILITY FOR USE

THE PRODUCTS CONTAINED IN THIS DOCUMENT ARE NOT SAFETY RATED. THEY ARE NOT DESIGNED OR RATED FOR ENSURING SAFETY OF PERSONS, AND SHOULD NOT BE RELIED UPON AS A SAFETY COMPONENT OR PROTECTIVE DEVICE FOR SUCH PURPOSES. Please refer to separate catalogs for OMRON's safety rated products.

OMRON shall not be responsible for conformity with any standards, codes, or regulations that apply to the combination of products in the customer's application or use of the product.

At the customer's request, OMRON will provide applicable third party certification documents identifying ratings and limitations of use that apply to the products. This information by itself is not sufficient for a complete determination of the suitability of the products in combination with the end product, machine, system, or other application or use.

The following are some examples of applications for which particular attention must be given. This is not intended to be an exhaustive list of all possible uses of the products, nor is it intended to imply that the uses listed may be suitable for the products:

- Outdoor use, uses involving potential chemical contamination or electrical interference, or conditions or uses not described in this document.
- Nuclear energy control systems, combustion systems, railroad systems, aviation systems, medical equipment, amusement machines, vehicles, safety equipment, and installations subject to separate industry or government regulations.
- Systems, machines, and equipment that could present a risk to life or property.

Please know and observe all prohibitions of use applicable to the products.

NEVER USE THE PRODUCTS FOR AN APPLICATION INVOLVING SERIOUS RISK TO LIFE OR PROPERTY WITHOUT ENSURING THAT THE SYSTEM AS A WHOLE HAS BEEN DESIGNED TO ADDRESS THE RISKS, AND THAT THE OMRON PRODUCT IS PROPERLY RATED AND INSTALLED FOR THE INTENDED USE WITHIN THE OVERALL EQUIPMENT OR SYSTEM.

PERFORMANCE DATA

Performance data given in this document is provided as a guide for the user in determining suitability and does not constitute a warranty. It may represent the result of OMRON's test conditions, and the users must correlate it to actual application requirements. Actual performance is subject to the OMRON Warranty and Limitations of Liability.

CHANGE IN SPECIFICATIONS

Product specifications and accessories may be changed at any time based on improvements and other reasons.

It is our practice to change model numbers when published ratings or features are changed, or when significant construction changes are made. However, some specifications of the product may be changed without any notice. When in doubt, special model numbers may be assigned to fix or establish key specifications for your application on your request. Please consult with your OMRON representative at any time to confirm actual specifications of purchased products.

DIMENSIONS AND WEIGHTS

Dimensions and weights are nominal and are not to be used for manufacturing purposes, even when tolerances are shown.

ERRORS AND OMISSIONS

The information in this document has been carefully checked and is believed to be accurate; however, no responsibility is assumed for clerical, typographical, or proofreading errors, or omissions.

PROGRAMMABLE PRODUCTS

OMRON shall not be responsible for the user's programming of a programmable product, or any consequence thereof.

COPYRIGHT AND COPY PERMISSION

This document shall not be copied for sales or promotions without permission.

This document is protected by copyright and is intended solely for use in conjunction with the product. Please notify us before copying or reproducing this document in any manner, for any other purpose. If copying or transmitting this document to another, please copy or transmit it in its entirety.

LED Safety

WARNING

The lighting of Intelligent Compact Cameras emits visible light, which may adversely affect the eyes in rare instances.
Do not look directly into the light emitted from the lighting. When the subject is a specular reflective object, protect your eyes from reflected light.



Displaying LED Labels

Attached the enclosed warning label in a readily visible location near the product, such as on the cable.



Note: Do not use this document to operate the Unit.

OMRON Corporation Industrial Automation Company
Tokyo, JAPAN

Contact: www.ia.omron.com

Regional Headquarters

OMRON EUROPE B.V.
Sensor Business Unit
Carl-Benz-Str. 4, D-71154 Nufringen, Germany
Tel: (49) 7032-811-0/Fax: (49) 7032-811-199

OMRON ASIA PACIFIC PTE. LTD.
No. 438A Alexandra Road # 05-05/08 (Lobby 2),
Alexandra Technopark,
Singapore 119967
Tel: (65) 6835-3011/Fax: (65) 6835-2711

OMRON ELECTRONICS LLC
One Commerce Drive Schaumburg,
IL 60173-5302 U.S.A.
Tel: (1) 847-843-7900/Fax: (1) 847-843-7787

OMRON (CHINA) CO., LTD.
Room 2211, Bank of China Tower,
200 Yin Cheng Zhong Road,
PuDong New Area, Shanghai, 200120, China
Tel: (86) 21-5037-2222/Fax: (86) 21-5037-2200

Authorized Distributor:

© OMRON Corporation 2011 All Rights Reserved.
In the interest of product improvement,
specifications are subject to change without notice.

Cat. No. **Q184-E1-01**

0711(0711)