

CSPEMI201AG

2 Channel Headset Speaker EMI Filter with ESD Protection

Product Description

The CSPEMI201AG is a dual low-pass filter array integrating two pi-style filters (C-R-C) that reduce EMI/RFI emissions while at the same time providing ESD protection. This part is custom-designed to interface with a speaker port on a cellular telephone or similar device. Each high quality filter provides more than 35 dB attenuation in the 800–2700 MHz range. These pi-style filters support bidirectional filtering, controlling EMI both to and from a speaker element. They also support bipolar signals with a cutoff frequency of 31 MHz, enabling audio signals to pass through without distortion.

In addition, the CSPEMI201AG provides a very high level of protection for sensitive electronic components that may be subjected to electrostatic discharge (ESD). The CSPEMI201AG can safely dissipate ESD strikes of ± 8 kV, the maximum requirement of the IEC 61000-4-2 international standard. Using the MIL-STD-883 (Method 3015) specification for Human Body Model (HBM) ESD, the device provides protection for contact discharges to greater than ± 15 kV.

The CSPEMI201AG is particularly well-suited for portable electronics (e.g. cellular telephones, PDAs, notebook computers) because of its small package and low weight. The CSPEMI201AG is available in a space-saving, low-profile Chip Scale Package with RoHS compliant lead-free finishing.

Features

- Two Channels of EMI Filtering
- Pi-Style EMI Filters in a Capacitor-Resistor-Capacitor (C-R-C) Network
- Greater than 40 dB Attenuation at 1 GHz
- ± 8 kV ESD Protection on each Channel (IEC 61000-4-2 Level 4, Contact Discharge)
- ± 15 kV ESD Protection in each Channel (HBM)
- Supports AC Signals – Ideal for Audio Applications
- Extremely Low Lead Inductance for Optimum Filter and ESD Performance
- 5-Bump, 0.930 x 1.410 mm Footprint Chip Scale Package (CSP)
- These Devices are Pb-Free and are RoHS Compliant

Applications

- EMI Filtering and ESD Protection for Headset Speaker Ports
- Wireless Handsets
- Handheld PCs / PDAs
- MP3 Players
- Digital Camcorders
- Notebooks
- Desktop PCs



ON Semiconductor®

<http://onsemi.com>



WLCSP5
AG SUFFIX
CASE 567AZ

ELECTRICAL SCHEMATIC

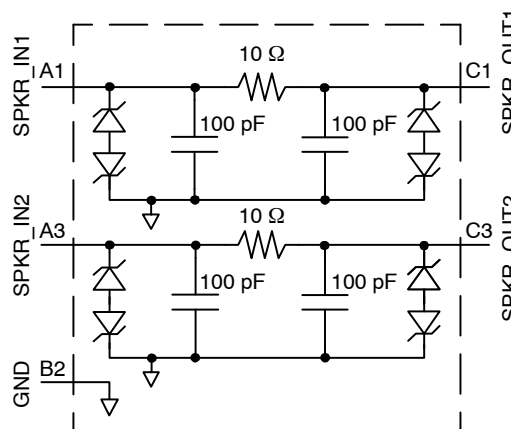

MARKING DIAGRAM

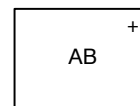

AB = CSPEMI201AG

ORDERING INFORMATION

| Device | Package | Shipping† |
|-------------|-----------------|------------------|
| CSPEMI201AG | CSP-5 (Pb-Free) | 3500/Tape & Reel |

†For information on tape and reel specifications, including part orientation and tape sizes, please refer to our Tape and Reel Packaging Specification Brochure, BRD8011/D.

CSPEMI201AG

Table 1. PIN DESCRIPTIONS

| 5-bump CSP Package | | |
|--------------------|-----------|--|
| Pin | Name | Description |
| A1 | SPKR_IN1 | Speaker Input 1 (from audio circuitry) |
| A3 | SPKR_IN2 | Speaker Input 2 (from audio circuitry) |
| B2 | GND | Device Ground |
| C1 | SPKR_OUT1 | Speaker Output 1 (to speaker) |
| C3 | SPKR_OUT1 | Speaker Output 2 (to speaker) |

PACKAGE / PINOUT DIAGRAMS

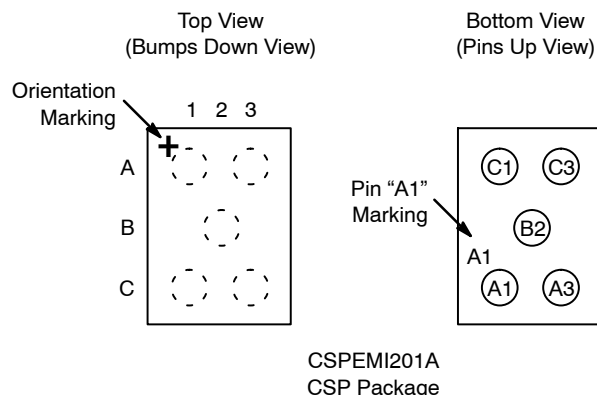

SPECIFICATIONS

Table 2. ABSOLUTE MAXIMUM RATINGS

| Parameter | Rating | Units |
|---------------------------|-------------|-------|
| Storage Temperature Range | -65 to +150 | °C |
| DC Power per Resistor | 100 | mW |
| DC Package Power Rating | 200 | mW |

Stresses exceeding Maximum Ratings may damage the device. Maximum Ratings are stress ratings only. Functional operation above the Recommended Operating Conditions is not implied. Extended exposure to stresses above the Recommended Operating Conditions may affect device reliability.

Table 3. STANDARD OPERATING CONDITIONS

| Parameter | Rating | Units |
|-----------------------------|------------|-------|
| Operating Temperature Range | -40 to +85 | °C |

Table 4. ELECTRICAL OPERATING CHARACTERISTICS (Note 1)

| Symbol | Parameter | Conditions | Min | Typ | Max | Units |
|-------------------|--|---------------------------|-----------|------------|----------|-------|
| R | Resistance | | 9 | 10 | 11 | Ω |
| C | Capacitance | | 80 | 100 | 120 | pF |
| I _{LEAK} | Diode Leakage Current | V _{IN} = 5.0 V | | | 1.0 | μA |
| V _{SIG} | Signal Voltage Positive Clamp Negative Clamp | I _{LOAD} = 10 mA | 5 -15 | 7 -10 | 15 -5 | V |
| V _{ESD} | In-system ESD Withstand Voltage a) Human Body Model, MIL-STD-883, Method 3015 b) Contact Discharge per IEC 61000-4-2 Level 4 | (Note 2) | ±15 ±8 | | | kV |
| V _{CL} | Clamping Voltage during ESD Discharge MIL-STD-883 (Method 3015), 8 kV Positive Transients Negative Transients | (Notes 2 and 3) | | +15 -19 | | V |
| f _C | Cut-off frequency Z _{SOURCE} = 50 Ω, Z _{LOAD} = 50 Ω | R = 10 Ω, C = 100 pF | | 31 | | MHz |

1. T_A = 25°C unless otherwise specified.
2. ESD applied to input and output pins with respect to GND, one at a time.
3. Clamping voltage is measured at the opposite side of the EMI filter to the ESD pin. For example, if ESD is applied to Pin A1, then clamping voltage is measured at Pin C1.

CSPEM1201AG

PERFORMANCE INFORMATION

Typical Filter Performance (nominal conditions unless specified otherwise, 50 Ω Environment)

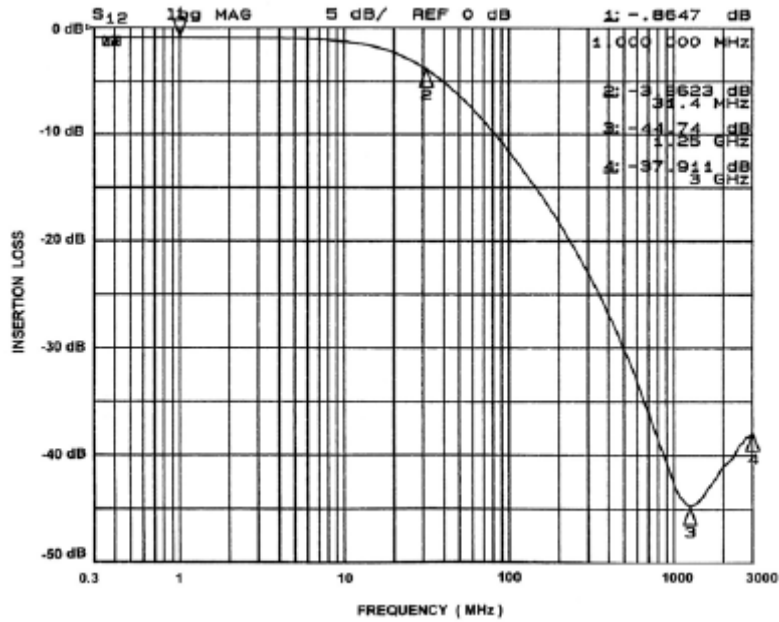

Figure 1. Insertion Loss vs. Frequency (A1-C1 to GND B2)

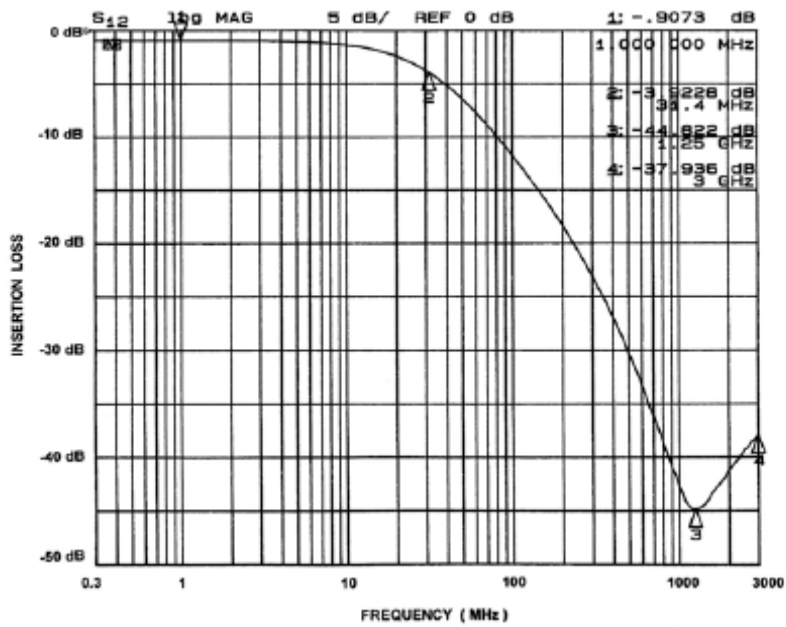

Figure 2. Insertion Loss vs. Frequency (A3-C3 to GND B2)

CSPEMI201AG

APPLICATION INFORMATION

| Parameter | Value |
|--|------------------------------|
| Pad Size on PCB | 0.240 mm |
| Pad Shape | Round |
| Pad Definition | Non-Solder Mask defined pads |
| Solder Mask Opening | 0.290 mm Round |
| Solder Stencil Thickness | 0.125 mm – 0.150 mm |
| Solder Stencil Aperture Opening (laser cut, 5% tapered walls) | 0.300 mm Round |
| Solder Flux Ratio | 50/50 by volume |
| Solder Paste Type | No Clean |
| Pad Protective Finish | OSP (Entek Cu Plus 106A) |
| Tolerance – Edge To Corner Ball | ±50 µm |
| Solder Ball Side Coplanarity | ±20 µm |
| Maximum Dwell Time Above Liquidous | 60 seconds |
| Maximum Soldering Temperature for Lead-free Devices using a Lead-free Solder Paste | 260°C |

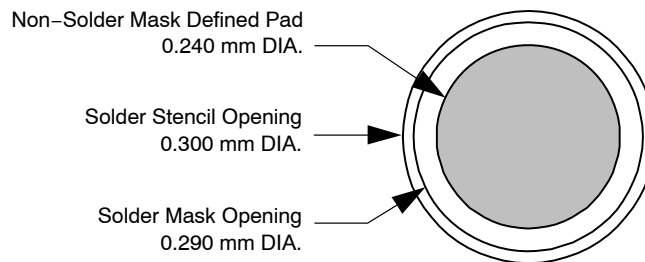

Figure 3. Recommended Non-Solder Mask Defined Pad Illustration

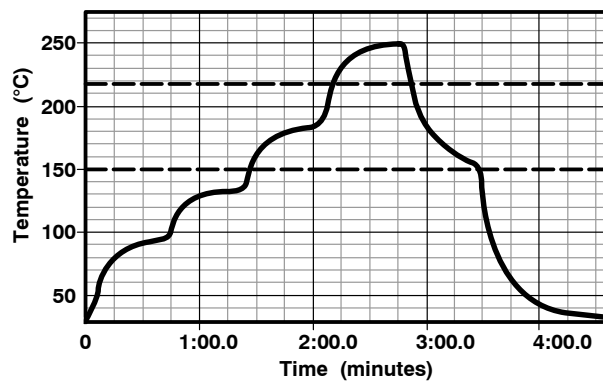

Figure 4. Lead-free (SnAgCu) Solder Ball Reflow Profile



SCALE 4:1

WLCSP5, 0.94x1.41
CASE 567AZ
ISSUE O

DATE 26 JUL 2010

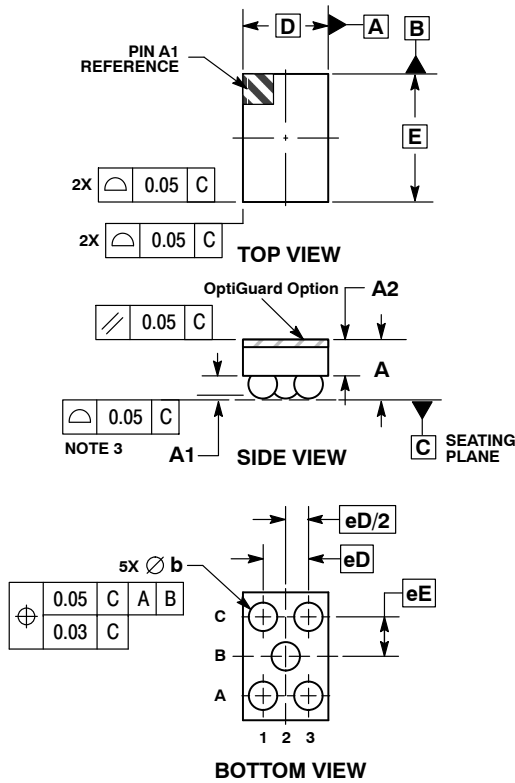

- NOTES:
1. DIMENSIONING AND TOLERANCING PER ASME Y14.5M, 1994.
 2. CONTROLLING DIMENSION: MILLIMETERS.
 3. COPLANARITY APPLIES TO SPHERICAL CROWNS OF SOLDER BALLS.

| DIM | MILLIMETERS | |
|-----|-------------|------|
| | MIN | MAX |
| A | 0.56 | 0.72 |
| A1 | 0.21 | 0.27 |
| A2 | 0.40 REF | |
| b | 0.29 | 0.35 |
| D | 0.94 BSC | |
| E | 1.41 BSC | |
| eD | 0.50 BSC | |
| eE | 0.435 BSC | |

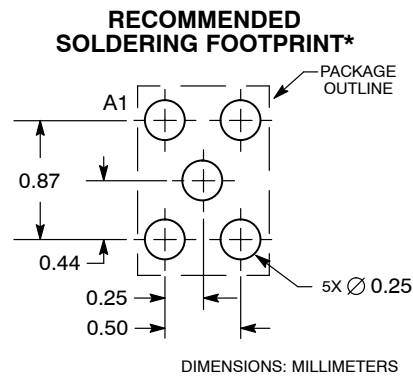

*For additional information on our Pb-Free strategy and soldering details, please download the ON Semiconductor Soldering and Mounting Techniques Reference Manual, SOLDERRM/D.

| | | |
|-------------------------|-------------------|--|
| DOCUMENT NUMBER: | 98AON49809E | Electronic versions are uncontrolled except when accessed directly from the Document Repository. Printed versions are uncontrolled except when stamped "CONTROLLED COPY" in red. |
| DESCRIPTION: | WLCSP5, 0.94X1.41 | PAGE 1 OF 1 |

onsemi and ONsemi are trademarks of Semiconductor Components Industries, LLC dba onsemi or its subsidiaries in the United States and/or other countries. onsemi reserves the right to make changes without further notice to any products herein. onsemi makes no warranty, representation or guarantee regarding the suitability of its products for any particular purpose, nor does onsemi assume any liability arising out of the application or use of any product or circuit, and specifically disclaims any and all liability, including without limitation special, consequential or incidental damages. onsemi does not convey any license under its patent rights nor the rights of others.

onsemi, **Onsemi**, and other names, marks, and brands are registered and/or common law trademarks of Semiconductor Components Industries, LLC dba "**onsemi**" or its affiliates and/or subsidiaries in the United States and/or other countries. **onsemi** owns the rights to a number of patents, trademarks, copyrights, trade secrets, and other intellectual property. A listing of **onsemi**'s product/patent coverage may be accessed at www.onsemi.com/site/pdf/Patent-Marking.pdf. **onsemi** reserves the right to make changes at any time to any products or information herein, without notice. The information herein is provided "as-is" and **onsemi** makes no warranty, representation or guarantee regarding the accuracy of the information, product features, availability, functionality, or suitability of its products for any particular purpose, nor does **onsemi** assume any liability arising out of the application or use of any product or circuit, and specifically disclaims any and all liability, including without limitation special, consequential or incidental damages. Buyer is responsible for its products and applications using **onsemi** products, including compliance with all laws, regulations and safety requirements or standards, regardless of any support or applications information provided by **onsemi**. "Typical" parameters which may be provided in **onsemi** data sheets and/or specifications can and do vary in different applications and actual performance may vary over time. All operating parameters, including "Typicals" must be validated for each customer application by customer's technical experts. **onsemi** does not convey any license under any of its intellectual property rights nor the rights of others. **onsemi** products are not designed, intended, or authorized for use as a critical component in life support systems or any FDA Class 3 medical devices or medical devices with a same or similar classification in a foreign jurisdiction or any devices intended for implantation in the human body. Should Buyer purchase or use **onsemi** products for any such unintended or unauthorized application, Buyer shall indemnify and hold **onsemi** and its officers, employees, subsidiaries, affiliates, and distributors harmless against all claims, costs, damages, and expenses, and reasonable attorney fees arising out of, directly or indirectly, any claim of personal injury or death associated with such unintended or unauthorized use, even if such claim alleges that **onsemi** was negligent regarding the design or manufacture of the part. **onsemi** is an Equal Opportunity/Affirmative Action Employer. This literature is subject to all applicable copyright laws and is not for resale in any manner.

ADDITIONAL INFORMATION

TECHNICAL PUBLICATIONS:

Technical Library: www.onsemi.com/design/resources/technical-documentation
onsemi Website: www.onsemi.com

ONLINE SUPPORT: www.onsemi.com/support

For additional information, please contact your local Sales Representative at www.onsemi.com/support/sales

