

**ebm-papst St. Georgen GmbH & Co. KG**

Hermann-Papst-Str. 1

D-78112 St. Georgen

Phone +49 (0) 7724 81-0

Fax +49 (0) 7724 81-1309

info2@de.ebmpapst.com

www.ebmpapst.com

**Nominal data**

Type	4418 M	
Nominal voltage	VDC	48
Nominal voltage range	VDC	36 .. 60
Speed (rpm)	min <sup>-1</sup>	3300
Power consumption	W	4.2
Min. ambient temperature	°C	-20
Max. ambient temperature	°C	70
Air flow	m <sup>3</sup> /h	184
Sound power level	B	5.3
Sound pressure level	dB(A)	42

ml = Max. load · me = Max. efficiency · fa = Free air · cs = Customer specification · ce = Customer equipment  
Subject to change



**Technical description**

<b>Housing material</b>	Glass-fiber reinforced PBT plastic
<b>Impeller material</b>	Glass-fiber reinforced PA plastic
<b>Weight</b>	0.250 kg
<b>Dimensions</b>	119 x 119 x 38 mm
<b>Airflow direction</b>	Exhaust over struts
<b>Direction of rotation</b>	Clockwise, viewed toward rotor
<b>Storage</b>	Ball bearing
<b>Service life L10 at 40 °C</b>	65000 h
<b>Service life L10 at maximum temperature</b>	32500 h
<b>Cable</b>	Leads AWG 24, TR 64, stripped and tin-plated.
<b>Motor protection</b>	Protection against reverse polarity and blocked rotor.
<b>Option</b>	Control inputs and alarm and speed signals.

## Product drawing

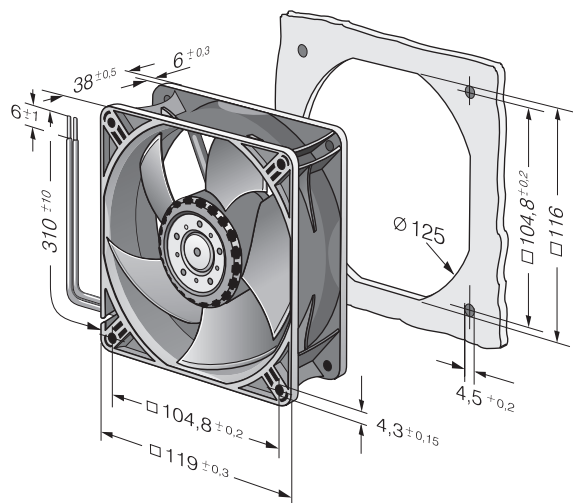

## Curves: Air performance

