

UTC Series Installation Accessories

Introduction

The UTC series installation accessories blend simplicity with style. It makes optimal use of space, and its compact design saves money in shipping fees. UTC-5 Series is elegantly designed to fit many different customer scenarios, from kiosks to reception areas. The slim and stylish unit is easy to store, easy to ship and easy to set up. Installation is simple; it can be done in about ten minutes and the finished result makes an attractive, one-piece solution.

Wall Mount

PN	UTC-WALL-MOUNT1E	UTC-WALL-MOUNT2E	UTC-WALL-MOUNT3E	UTC-WALL-MOUNT4E	UTC-WALL-MOUNT5E
VESA Mounting Patterns	75 x 75 mm; 100 x 100 mm	200 x 200 mm	75 x 75 mm; 100 x 100 mm	75 x 75 mm	75 x 75 mm
Weight Capacity	14 kg	35 kg	20 kg	20 kg	20 kg

UTC-WALL-MOUNT1E

VESA 75/100 mm



- Firmly fix to a solid wall
- Weight capacity up to 14 kg
- Material: Steel
- Tilt: 180° up and down

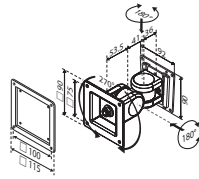

- Rotation: 270° for portrait or landscape viewing
- Lift: 130.5 mm
- For UTC-115/120/307/310/315/318/320/510/515/520

UTC-WALL-MOUNT2E

VESA 100/200 mm



- Flush fit without movement
- Weight capacity up to 35 kg
- Material: Steel

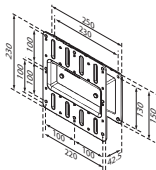

- Sits: 42.5 mm from the wall
- For UTC-532/542

UTC-WALL-MOUNT3E

VESA 75/100 mm



- Firmly fix to a solid wall
- Weight capacity up to 20 kg
- Material: Steel

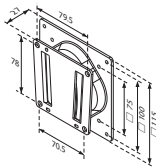

- Sits: 27 mm from the wall
- For UTC-115/120/310/315/318/320/515/520

UTC-WALL-MOUNT4E

VESA 75 mm



- Handy and Convenient supporter
- Firmly fix to solid wall
- Material: Steel

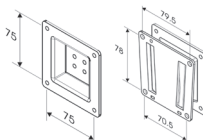

- Weight capacity up to 20 kg
- For UTC-310/510

UTC-WALL-MOUNT5E

VESA 75 mm



- Firmly fix to a solid wall
- Weight capacity up to 20 kg
- Material: Steel

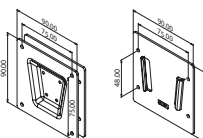

- Sits: 8 mm from the wall
- For UTC-510

Floor Stand

PN	UTC-T01-STANDE	UTC-H01-STANDE
Description	Triangle shape floor stand	H-shape floor stand
VESA Mounting Patterns	75 x 75 mm; 100 x 100 mm	75 x 75 mm; 100 x 100 mm; 200 x 200 mm
Height	120 cm	120 cm
Dimension	Ø660 mm	558 x 510 mm
Weight	10 kg	10 kg
Weight Capacity	18 KG (39.6lbs)	

UTC-T01-STANDE

Triangle shape floor stand

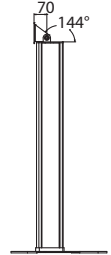
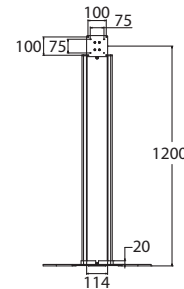
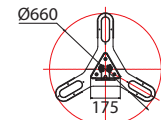

- Organized cable management
- VESA 75/100 mm
- Height: 120 cm
- Easily tilt for best viewing comfort
- Dimension: Ø660 mm
- For UTC-115/120/315/318/320/515/520

UTC-H01-STANDE

H-shape floor stand

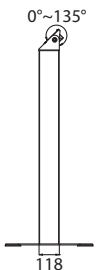
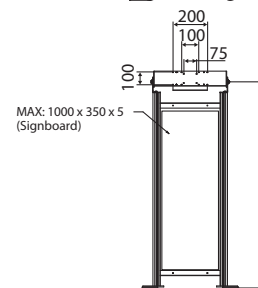
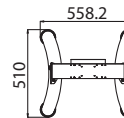

MAX: 1000 x 350 x 5 (Signboard)

- Organized cable management
- VESA 75/100/200mm
- Height: 120 cm
- Easily tilt for best viewing comfort
- Dimension: 558 x 510 mm
- Acrylics signboard is excluded
- For UTC-315/318/320/515/520/532/542

UTC Series Installation Accessories

Desktop Stand

PN	UTC-S01-STAND	UTC-S03-STANDE	UTC-510-STAND0E	UTC-520-STAND1E
Description	Tiltable Desktop Stand	Tiltable Desktop Stand	UTC-510 desktop stand with adapter holder	UTC-520 desktop stand
VESA Mounting Patterns	75 x 75 mm; 100 x 100 mm	75 x 75 mm	75 x 75 mm	N/A
Dimension	203 x 275 x 227 mm (8" x 10.83" x 8.94")	203 x 213 x 227 mm (7.99" x 8.39" x 8.94")	240L x 215W x 290H	230L x 160W x 44H
Weight	1.75kg	2kg	0.85kg	0.4kg
Weight Capacity	15kg	13kg	2.5kg	13kg

UTC-S01-STAND

VESA 75 x 75 mm ; 100 x 100 mm

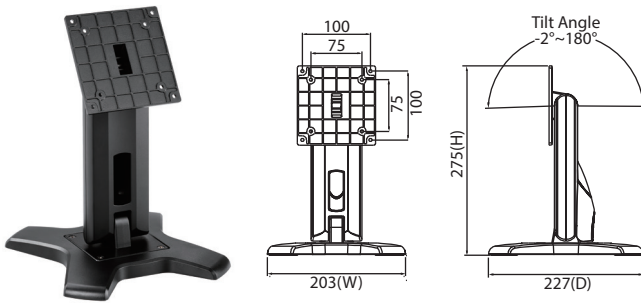

- Mounting Pattern: 100 x 100 / 75 x 75 mm
- Screw Type: M4
- Material: Steel/Plastic/Aluminum
- Dimension (W x H x D): 203 x 275 x 227 mm (8" x 10.83" x 8.94")
- Weight (Net): 1.75 Kg (3.86lbs)
- Tilt (Hinge): +180° / -2°
- Support Max.Weight: 15kg (33.1lbs)
- Support UTC-515/520/315/318/320

UTC-S03-STANDE

VESA 75 x 75 mm

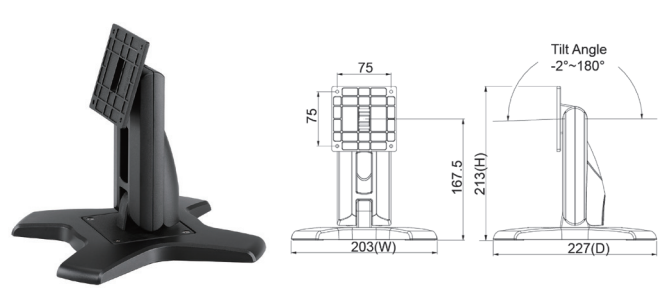

- Mounting Pattern: 75 x 75 mm
- Screw Type: M4
- Material: Steel/Plastic/Zinc
- Dimension (W x H x D): 203 x 213 x 227 mm (7.99" x 8.39" x 8.94")
- Weight (Net): 1.60 Kg (3.53lbs)
- Tilt (Hinge): +180° / -2°
- Support Max.Weight: 13kg (28.7lbs)
- Support UTC Models: UTC-510/307/310

UTC-510-STAND0E

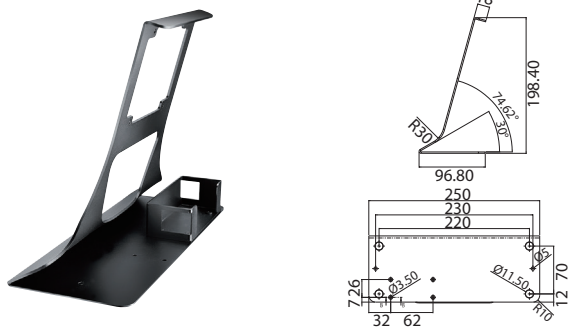

- Material: Steel
- Dimension: 240L x 215W x 290H
- Weight (Net): 0.85kg
- Support Flat Panel Size: 10"
- Support Max Weight: 2.5kg
- For UTC-510

UTC-520-STAND1E

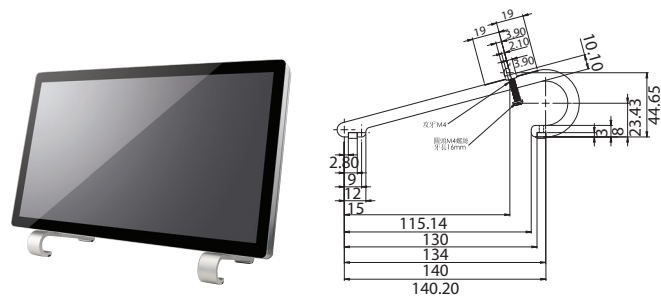

- Material: Steel
- Dimension: 230L x 160W x 44H
- Weight (Net): 0.4kg
- Support Max.Weight: 13kg (28.7lbs)
- Support UTC Models: UTC-515 and 520 series

Vesa Standard	Hole Pattern	Screw Size	Monitor Weight	Screen Size
FDMI MIS-B	50 x 20 mm	M4 x 6 mm	≤ 4.4 lbs / ≤ 2 kg	4" to 7.9"
FDMI MIS-C	75 x 35 mm	M4 x 8 mm	≤ 10 lbs / ≤ 4.5 kg	8" to 11.9"
FDMI MIS-D	75 x 75 or 100 x 100 mm	M4 x 10 mm	≤ 30.8 lbs / ≤ 14 kg	12" to 23.9"
FDMI MIS-E	200 x 100 mm	M4 x 10 mm	≤ 50 lbs / ≤ 23.7 kg	24" to 30.9"
FDMI MIS-F	200 mm increments	M6 x 8 mm or 10 mm; M8 x 15 mm	≤ 250 lbs / ≤ 113.6 kg	≥ 31"