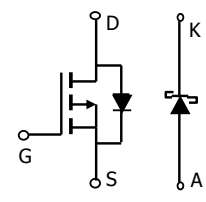
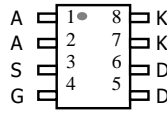
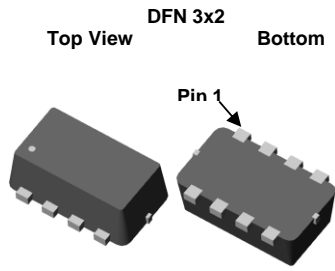


### General Description

The AON4703 uses advanced trench technology to provide excellent  $R_{DS(ON)}$  and low gate charge. A Schottky diode is provided to facilitate the implementation of a bidirectional blocking switch, or for buck converter applications.

### Features

$V_{DS} (V) = -20V$   
 $I_D = -3.4A \quad (V_{GS} = -4.5V)$   
 $R_{DS(ON)} < 90m\Omega \quad (V_{GS} = -4.5V)$   
 $R_{DS(ON)} < 120m\Omega \quad (V_{GS} = -2.5V)$   
 $R_{DS(ON)} < 160m\Omega \quad (V_{GS} = -1.8V)$   
**SCHOTTKY**  
 $V_{KA} (V) = 20V, I_F = 1A, V_F < 0.5V @ 1A$



### Absolute Maximum Ratings $T_A=25^\circ C$ unless otherwise noted

Parameter	Symbol	MOSFET	Schottky	Units
Drain-Source Voltage	$V_{DS}$	-20		V
Gate-Source Voltage	$V_{GS}$	$\pm 8$		V
Continuous Drain Current <sup>A</sup>	$I_D$	$T_A=25^\circ C$	-3.4	A
		$T_A=70^\circ C$	-2.7	
Pulsed Drain Current <sup>B</sup>	$I_{DM}$	-15		
Schottky reverse voltage	$V_{KA}$		20	V
Continuous Forward Current <sup>A</sup>	$I_F$	$T_A=25^\circ C$	1.9	A
		$T_A=70^\circ C$	1.2	
Pulsed Forward Current <sup>B</sup>	$I_{FM}$		7	
Power Dissipation	$P_D$	$T_A=25^\circ C$	1.7	W
		$T_A=70^\circ C$	1.1	
Junction and Storage Temperature Range	$T_J, T_{STG}$	-55 to 150	-55 to 150	$^\circ C$

Parameter: Thermal Characteristics MOSFET	Symbol	Typ	Max	Units
Maximum Junction-to-Ambient <sup>A</sup>	$R_{\theta JA}$	51	75	$^\circ C/W$
Maximum Junction-to-Ambient <sup>A</sup>				
Maximum Junction-to-Lead <sup>C</sup>	$R_{\theta JL}$	28	35	
<b>Thermal Characteristics Schottky</b>				
Maximum Junction-to-Ambient <sup>A</sup>	$R_{\theta JA}$	66	80	$^\circ C/W$
Maximum Junction-to-Ambient <sup>A</sup>				
Maximum Junction-to-Lead <sup>C</sup>	$R_{\theta JL}$	40	50	

**Electrical Characteristics (T<sub>J</sub>=25°C unless otherwise noted)**

Symbol	Parameter	Conditions	Min	Typ	Max	Units
<b>STATIC PARAMETERS</b>						
BV <sub>DSS</sub>	Drain-Source Breakdown Voltage	I <sub>D</sub> =-250μA, V <sub>GS</sub> =0V	-20			V
I <sub>DSS</sub>	Zero Gate Voltage Drain Current	V <sub>DS</sub> =-20V, V <sub>GS</sub> =0V T <sub>J</sub> =55°C			-1 -5	μA
I <sub>GSS</sub>	Gate-Body leakage current	V <sub>DS</sub> =0V, V <sub>GS</sub> =±8V			±100	nA
V <sub>GS(th)</sub>	Gate Threshold Voltage	V <sub>DS</sub> =V <sub>GS</sub> , I <sub>D</sub> =-250μA	-0.4	-0.65	-1	V
I <sub>D(ON)</sub>	On state drain current	V <sub>GS</sub> =-4.5V, V <sub>DS</sub> =-5V	-15			A
R <sub>DS(ON)</sub>	Static Drain-Source On-Resistance	V <sub>GS</sub> =-4.5V, I <sub>D</sub> =-3.4A T <sub>J</sub> =125°C		51 64	90 135	mΩ
		V <sub>GS</sub> =-2.5V, I <sub>D</sub> =-2.5A		65	120	mΩ
		V <sub>GS</sub> =-1.8V, I <sub>D</sub> =-1.5A		83	160	mΩ
g <sub>FS</sub>	Forward Transconductance	V <sub>DS</sub> =-5V, I <sub>D</sub> =-3.4A		12		S
V <sub>SD</sub>	Diode Forward Voltage	I <sub>S</sub> =-1A, V <sub>GS</sub> =0V		-0.7	-1	V
I <sub>S</sub>	Maximum Body-Diode Continuous Current				-2	A
<b>DYNAMIC PARAMETERS</b>						
C <sub>iss</sub>	Input Capacitance	V <sub>GS</sub> =0V, V <sub>DS</sub> =-10V, f=1MHz		560	745	pF
C <sub>oss</sub>	Output Capacitance			80		pF
C <sub>rss</sub>	Reverse Transfer Capacitance			70		pF
R <sub>g</sub>	Gate resistance	V <sub>GS</sub> =0V, V <sub>DS</sub> =0V, f=1MHz		15	23	Ω
<b>SWITCHING PARAMETERS</b>						
Q <sub>g</sub>	Total Gate Charge	V <sub>GS</sub> =-4.5V, V <sub>DS</sub> =-10V, I <sub>D</sub> =-3.4A		8.5	11	nC
Q <sub>gs</sub>	Gate Source Charge			1.2		nC
Q <sub>gd</sub>	Gate Drain Charge			2.1		nC
t <sub>D(on)</sub>	Turn-On DelayTime	V <sub>GS</sub> =-4.5V, V <sub>DS</sub> =-10V, R <sub>L</sub> =2.9Ω, R <sub>GEN</sub> =3Ω		7.2		ns
t <sub>r</sub>	Turn-On Rise Time			36		ns
t <sub>D(off)</sub>	Turn-Off DelayTime			53		ns
t <sub>f</sub>	Turn-Off Fall Time			56		ns
t <sub>rr</sub>	Body Diode Reverse Recovery Time	I <sub>F</sub> =-3.4A, dI/dt=100A/μs		37	49	ns
Q <sub>rr</sub>	Body Diode Reverse Recovery Charge	I <sub>F</sub> =-3.4A, dI/dt=100A/μs		27		nC
<b>SCHOTTKY PARAMETERS</b>						
V <sub>F</sub>	Forward Voltage Drop	I <sub>F</sub> =1A		0.4	0.5	V
I <sub>rm</sub>	Maximum reverse leakage current	V <sub>R</sub> =16V			0.2	mA
		V <sub>R</sub> =16V, T <sub>J</sub> =125°C			20	
C <sub>T</sub>	Junction Capacitance	V <sub>R</sub> =10V		44		pF
t <sub>rr</sub>	Schottky Reverse Recovery Time	I <sub>F</sub> =1A, dI/dt=100A/μs		11	14	ns
Q <sub>rr</sub>	Schottky Reverse Recovery Charge	I <sub>F</sub> =1A, dI/dt=100A/μs		2.5		nC

A: The value of R<sub>θJA</sub> is measured with the device mounted on 1in<sup>2</sup> FR-4 board with 2oz. Copper, in a still air environment with T<sub>A</sub> = 25° C.

The value in any given application depends on the user's specific board design.

B: Repetitive rating, pulse width limited by junction temperature.

C: The R<sub>θJA</sub> is the sum of the thermal impedance from junction to lead R<sub>θJL</sub> and lead to ambient.

D: The static characteristics in Figures 1 to 6 are obtained using t ≤ 300μs pulses, duty cycle 0.5% max.

E: These tests are performed with the device mounted on 1 in<sup>2</sup> FR-4 board with 2oz. Copper, in a still air environment with T<sub>A</sub>=25° C. The SOA curve provides a single pulse rating.

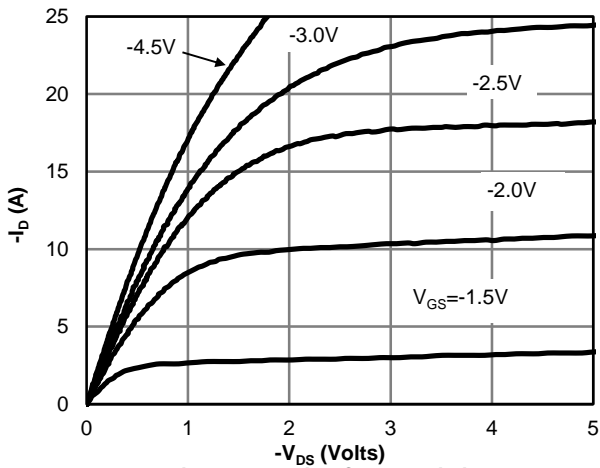
F: The current rating is based on the t ≤ 10s thermal resistance rating.

APPLICATIONS OR USES AS CRITICAL COMPONENTS IN LIFE SUPPORT DEVICES OR SYSTEMS ARE NOT AUTHORIZED. AOS DOES NOT ASSUME ANY LIABILITY ARISING OUT OF SUCH APPLICATIONS OR USES OF ITS PRODUCTS. AOS RESERVES THE RIGHT TO MAKE CHANGES TO PRODUCT SPECIFICATIONS WITHOUT NOTICE. IT IS THE RESPONSIBILITY OF THE CUSTOMER TO EVALUATE SUITABILITY OF THE PRODUCT FOR THEIR INTENDED APPLICATION. CUSTOMER SHALL COMPLY WITH APPLICABLE LEGAL REQUIREMENTS, INCLUDING ALL APPLICABLE EXPORT CONTROL RULES, REGULATIONS AND LIMITATIONS.

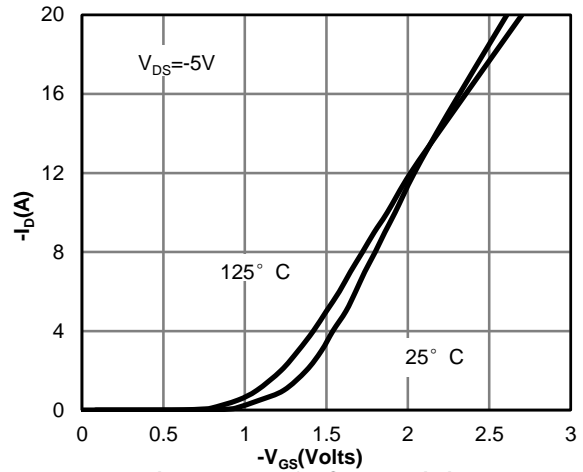
AOS' products are provided subject to AOS' terms and conditions of sale which are set forth at:

[http://www.aosmd.com/terms\\_and\\_conditions\\_of\\_sale](http://www.aosmd.com/terms_and_conditions_of_sale)

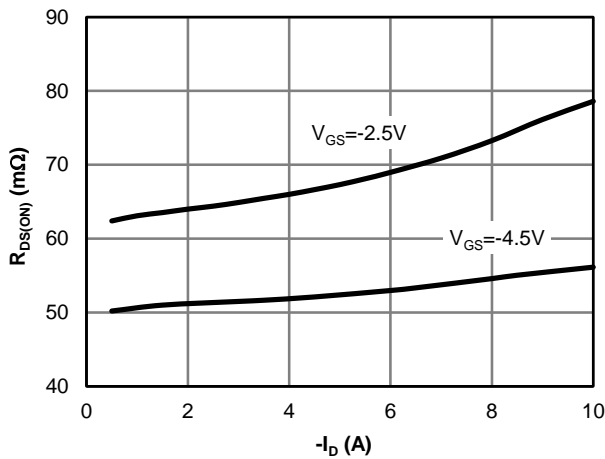
**TYPICAL ELECTRICAL AND THERMAL CHARACTERISTICS**



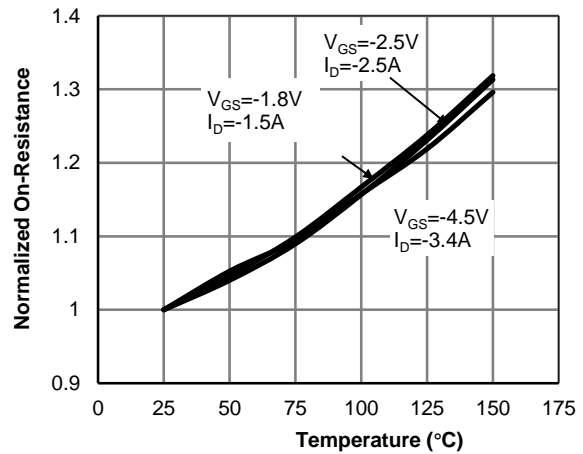
**Fig 1: On-Region Characteristics**



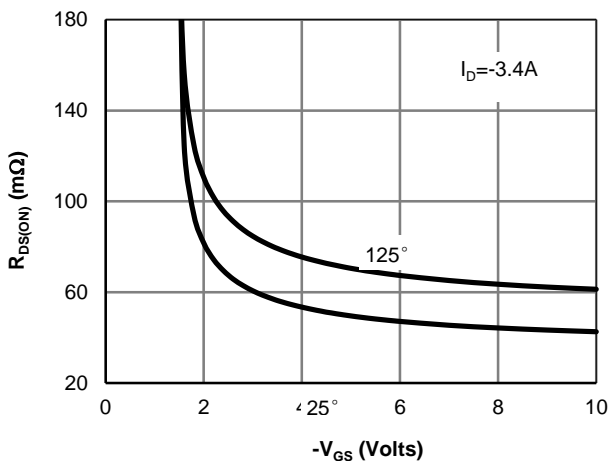
**Figure 2: Transfer Characteristics**



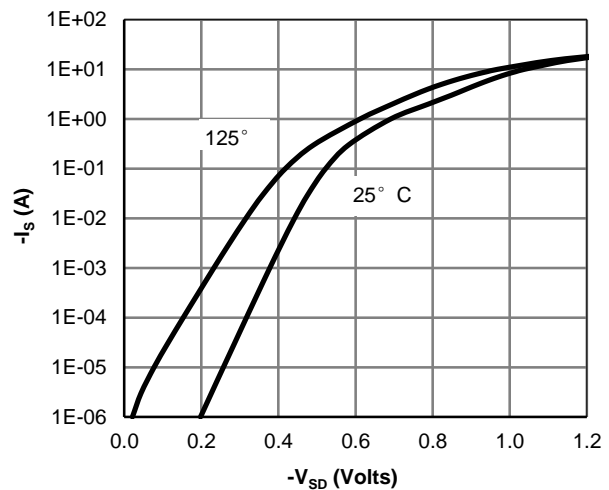
**Figure 3: On-Resistance vs. Drain Current and Gate Voltage**



**Figure 4: On-Resistance vs. Junction Temperature**

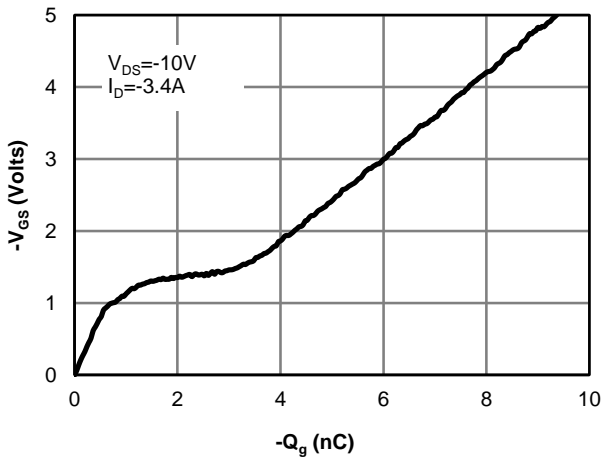


**Figure 5: On-Resistance vs. Gate-Source Voltage**

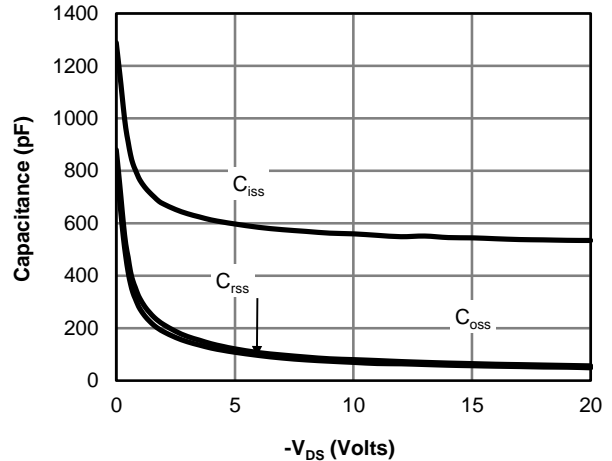


**Figure 6: Body-Diode Characteristics**

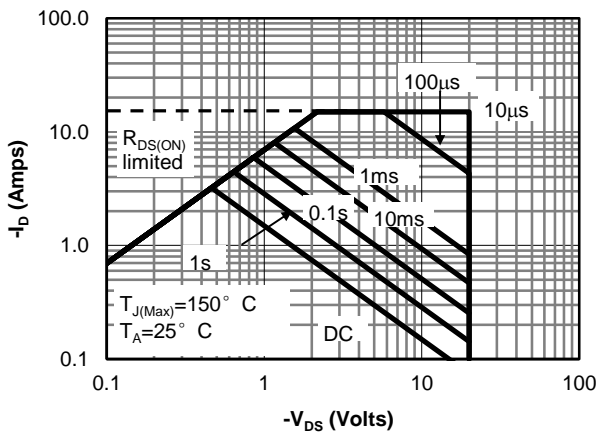
**TYPICAL ELECTRICAL AND THERMAL CHARACTERISTICS**



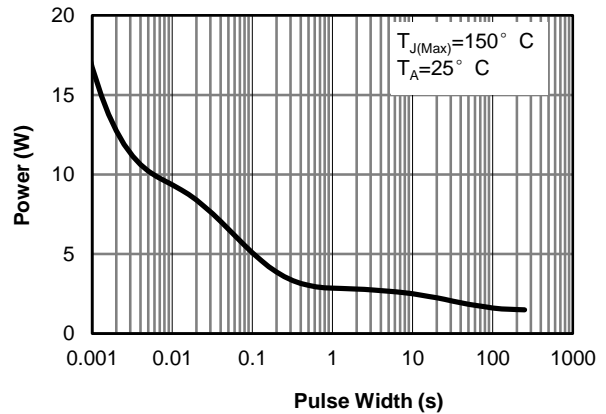
**Figure 7: Gate-Charge Characteristics**



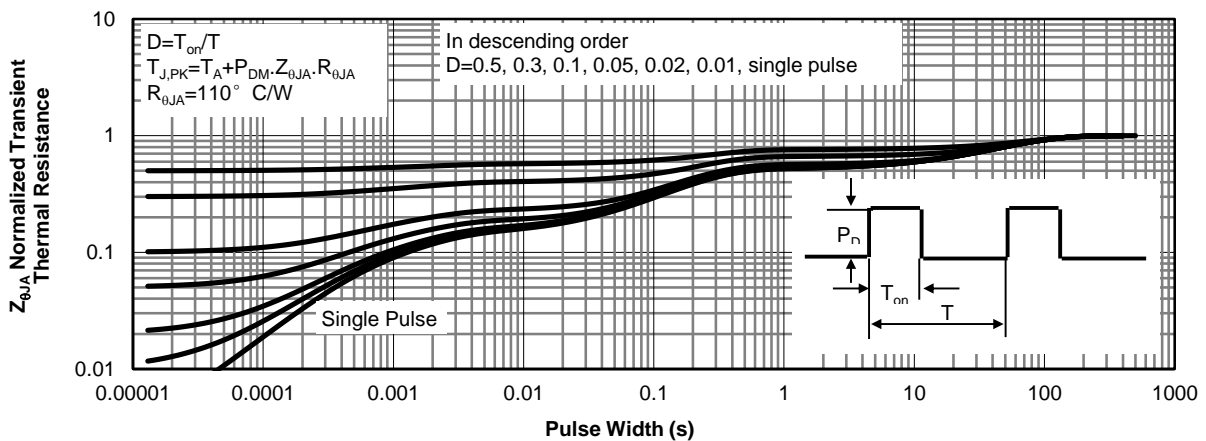
**Figure 8: Capacitance Characteristics**



**Figure 9: Maximum Forward Biased Safe Operating Area (Note E)**



**Figure 10: Single Pulse Power Rating Junction-to-Ambient (Note E)**



**Figure 11: Normalized Maximum Transient Thermal Impedance**

**TYPICAL ELECTRICAL AND THERMAL CHARACTERISTICS: SCHOTTKY**

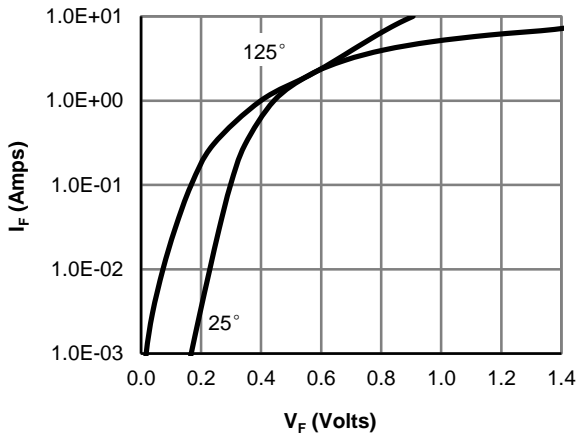


Figure 12: Schottky Forward Characteristics

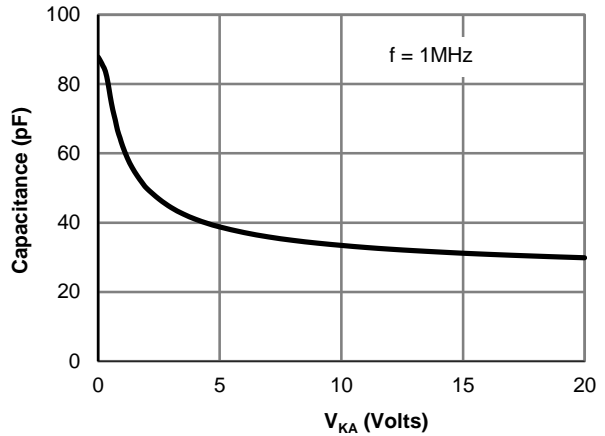


Figure 13: Schottky Capacitance Characteristics

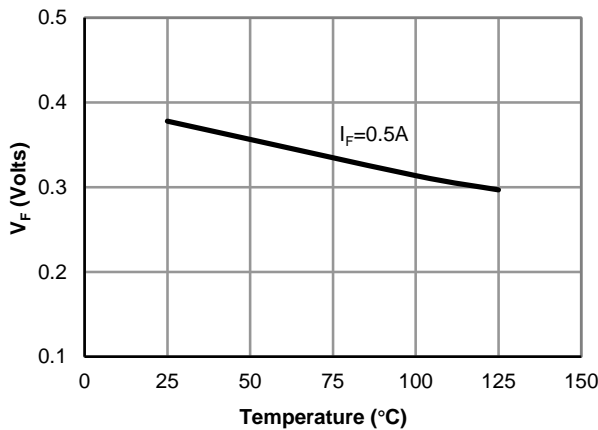


Figure 14: Schottky Forward Drop vs. Junction Temperature

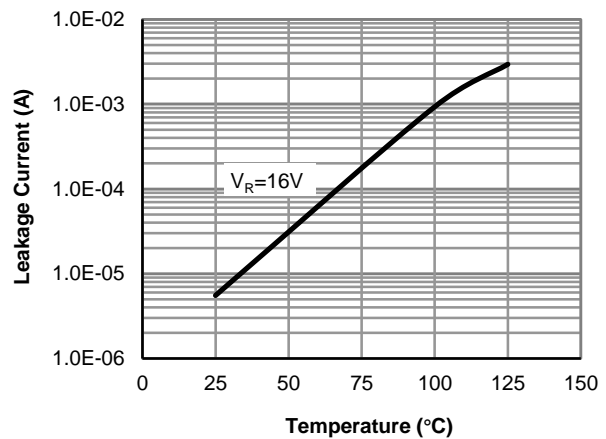


Figure 15: Schottky Leakage current vs. Junction Temperature

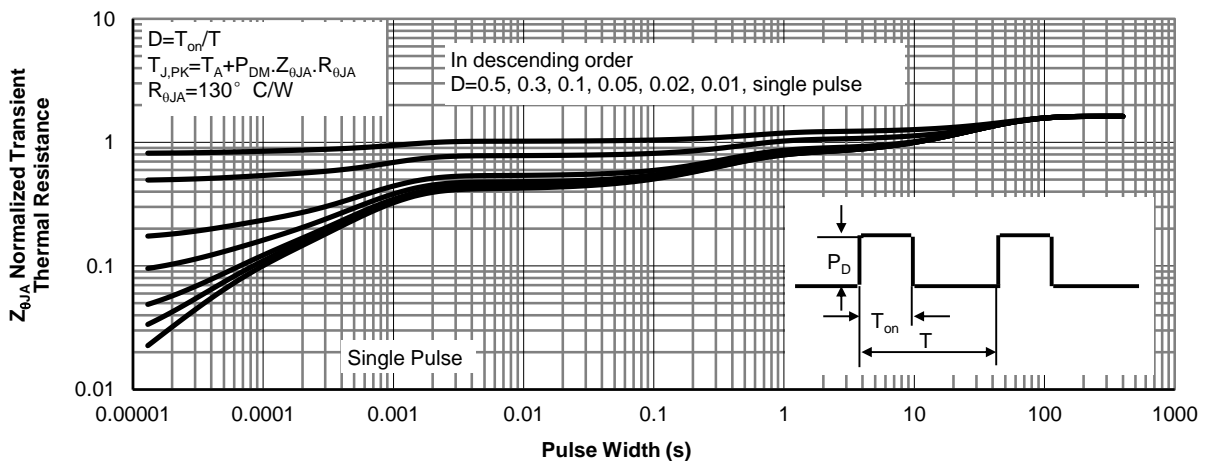
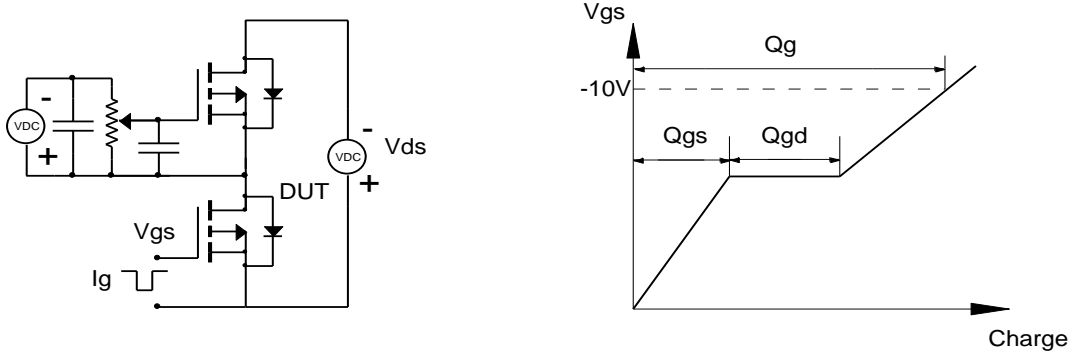
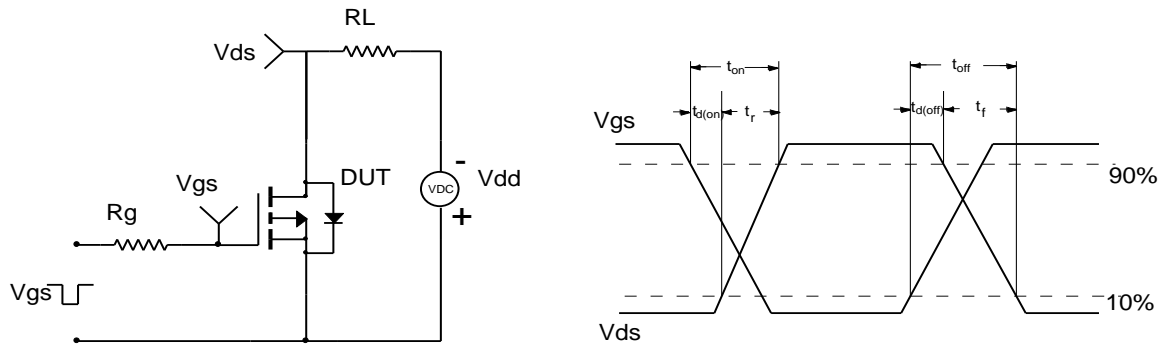


Figure 16: Schottky Normalized Maximum Transient Thermal Impedance

**Gate Charge Test Circuit & Waveform**



**Resistive Switching Test Circuit & Waveforms**



**Diode Recovery Test Circuit & Waveforms**

