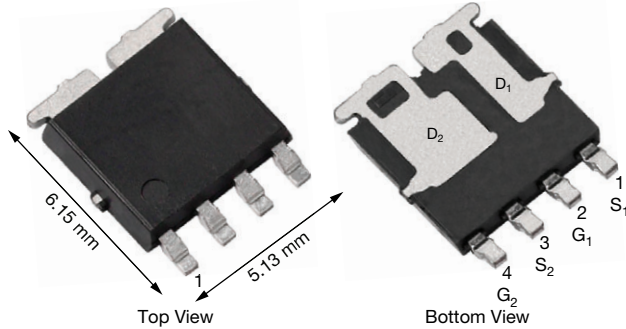

Automotive Dual N-Channel 60 V (D-S) 175 °C MOSFETs

PowerPAK® SO-8L Dual Asymmetric

FEATURES

- TrenchFET® power MOSFET
- AEC-Q101 qualified
- 100 % R_g and UIS tested
- Optimized for synchronous buck applications
- Material categorization:
for definitions of compliance please see www.vishay.com/doc?99912

 AUTOMOTIVE
GRADE

RoHS
COMPLIANT
HALOGEN
FREE

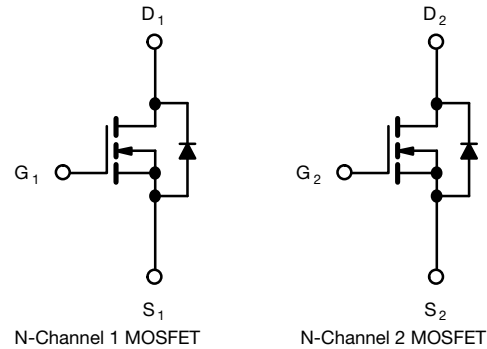
PRODUCT SUMMARY		
	N-CHANNEL 1	N-CHANNEL 2
V _{DS} (V)	60	60
R _{DS(on)} (Ω) at V _{GS} = 10 V	0.0355	0.0155
R _{DS(on)} (Ω) at V _{GS} = 4.5 V	0.0480	0.0200
I _D (A)	15	40
Configuration	Dual	
Package	PowerPAK SO-8L asymmetric	



ABSOLUTE MAXIMUM RATINGS (T _C = 25 °C, unless otherwise noted)				
PARAMETER	SYMBOL	N-CHANNEL 1	N-CHANNEL 2	UNIT
Drain-source voltage	V _{DS}	60	60	V
Gate-source voltage	V _{GS}	± 20		
Continuous drain current	I _D	T _C = 25 °C	15 ^a	A
		T _C = 125 °C	11	
Continuous source current (diode conduction)	I _S	15 ^a	44	A
Pulsed drain current ^b	I _{DM}	30	70	
Single pulse avalanche current	I _{AS}	12	20	mJ
Single pulse avalanche energy	E _{AS}	7.2	20	
Maximum power dissipation ^b	P _D	T _C = 25 °C	27	W
		T _C = 125 °C	9	
Operating junction and storage temperature range	T _J , T _{stg}	-55 to +175		°C
Soldering recommendations (peak temperature) ^{d, e}		260		

THERMAL RESISTANCE RATINGS				
PARAMETER	SYMBOL	N-CHANNEL 1	N-CHANNEL 2	UNIT
Junction-to-ambient	R _{thJA}	85	85	°C/W
Junction-to-case (drain)	R _{thJC}	5.5	3.1	

Notes

- Package limited
- Pulse test; pulse width ≤ 300 μs, duty cycle ≤ 2 %
- When mounted on 1" square PCB (FR4 material)
- See solder profile (www.vishay.com/doc?73257). The PowerPAK SO-8L is a leadless package. The end of the lead terminal is exposed copper (not plated) as a result of the singulation process in manufacturing. A solder fillet at the exposed copper tip cannot be guaranteed and is not required to ensure adequate bottom side solder interconnection
- Rework conditions: manual soldering with a soldering iron is not recommended for leadless components



SPECIFICATIONS ($T_C = 25\text{ }^\circ\text{C}$, unless otherwise noted)									
PARAMETER	SYMBOL	TEST CONDITIONS			MIN.	TYP.	MAX.	UNIT	
Static									
Drain-source breakdown voltage	V_{DS}	$V_{GS} = 0\text{ V}, I_D = 250\text{ }\mu\text{A}$		N-Ch 1	60	-	-	V	
		$V_{GS} = 0\text{ V}, I_D = 250\text{ }\mu\text{A}$		N-Ch 2	60	-	-		
Gate-source threshold voltage	$V_{GS(th)}$	$V_{DS} = V_{GS}, I_D = 250\text{ }\mu\text{A}$		N-Ch 1	1.5	2.0	2.5	V	
		$V_{DS} = V_{GS}, I_D = 250\text{ }\mu\text{A}$		N-Ch 2	1.5	2.0	2.5		
Gate-source leakage	I_{GSS}	$V_{DS} = 0\text{ V}, V_{GS} = \pm 20\text{ V}$		N-Ch 1	-	-	± 100	nA	
				N-Ch 2	-	-	± 100		
Zero gate voltage drain current	I_{DSS}	$V_{GS} = 0\text{ V}$	$V_{DS} = 60\text{ V}$	N-Ch 1	-	-	1	μA	
		$V_{GS} = 0\text{ V}$	$V_{DS} = 60\text{ V}$	N-Ch 2	-	-	1		
		$V_{GS} = 0\text{ V}$	$V_{DS} = 60\text{ V}, T_J = 125\text{ }^\circ\text{C}$	N-Ch 1	-	-	50		
		$V_{GS} = 0\text{ V}$	$V_{DS} = 60\text{ V}, T_J = 125\text{ }^\circ\text{C}$	N-Ch 2	-	-	50		
		$V_{GS} = 0\text{ V}$	$V_{DS} = 60\text{ V}, T_J = 175\text{ }^\circ\text{C}$	N-Ch 1	-	-	250		
		$V_{GS} = 0\text{ V}$	$V_{DS} = 60\text{ V}, T_J = 175\text{ }^\circ\text{C}$	N-Ch 2	-	-	250		
On-state drain current ^a	$I_{D(on)}$	$V_{GS} = 10\text{ V}$	$V_{DS} \geq 5\text{ V}$	N-Ch 1	10	-	-	A	
		$V_{GS} = 10\text{ V}$	$V_{DS} \geq 5\text{ V}$	N-Ch 2	20	-	-		
Drain-source on-state resistance ^a	$R_{DS(on)}$	$V_{GS} = 10\text{ V}$	$I_D = 2\text{ A}$	N-Ch 1	-	0.0295	0.0355	Ω	
		$V_{GS} = 10\text{ V}$	$I_D = 5\text{ A}$	N-Ch 2	-	0.0126	0.0155		
		$V_{GS} = 10\text{ V}$	$I_D = 2\text{ A}, T_J = 125\text{ }^\circ\text{C}$	N-Ch 1	-	-	0.0563		
		$V_{GS} = 10\text{ V}$	$I_D = 5\text{ A}, T_J = 125\text{ }^\circ\text{C}$	N-Ch 2	-	-	0.0253		
		$V_{GS} = 10\text{ V}$	$I_D = 2\text{ A}, T_J = 175\text{ }^\circ\text{C}$	N-Ch 1	-	-	0.0700		
		$V_{GS} = 10\text{ V}$	$I_D = 5\text{ A}, T_J = 175\text{ }^\circ\text{C}$	N-Ch 2	-	-	0.0311		
		$V_{GS} = 4.5\text{ V}$	$I_D = 1\text{ A}$	N-Ch 1	-	0.0400	0.0480		
		$V_{GS} = 4.5\text{ V}$	$I_D = 3\text{ A}$	N-Ch 2	-	0.0165	0.0200		
Dynamic ^b									
Input capacitance	C_{iss}	$V_{GS} = 0\text{ V}$	$V_{DS} = 25\text{ V}, f = 1\text{ MHz}$	N-Ch 1	-	410	550	pF	
		$V_{GS} = 0\text{ V}$	$V_{DS} = 25\text{ V}, f = 1\text{ MHz}$	N-Ch 2	-	967	1260		
Output capacitance	C_{oss}	$V_{GS} = 0\text{ V}$	$V_{DS} = 25\text{ V}, f = 1\text{ MHz}$	N-Ch 1	-	212	280	pF	
		$V_{GS} = 0\text{ V}$	$V_{DS} = 25\text{ V}, f = 1\text{ MHz}$	N-Ch 2	-	436	570		
Reverse transfer capacitance	C_{rss}	$V_{GS} = 0\text{ V}$	$V_{DS} = 25\text{ V}, f = 1\text{ MHz}$	N-Ch 1	-	15	20	pF	
		$V_{GS} = 0\text{ V}$	$V_{DS} = 25\text{ V}, f = 1\text{ MHz}$	N-Ch 2	-	18	25		
Total gate charge ^c	Q_g	$V_{GS} = 10\text{ V}$	$V_{DS} = 30\text{ V}, I_D = 1\text{ A}$	N-Ch 1	-	6.5	10	nC	
		$V_{GS} = 10\text{ V}$	$V_{DS} = 30\text{ V}, I_D = 2\text{ A}$	N-Ch 2	-	14.5	23		
Gate-source charge ^c	Q_{gs}	$V_{GS} = 10\text{ V}$	$V_{DS} = 30\text{ V}, I_D = 1\text{ A}$	N-Ch 1	-	1.4	-	nC	
		$V_{GS} = 10\text{ V}$	$V_{DS} = 30\text{ V}, I_D = 2\text{ A}$	N-Ch 2	-	2.7	-		
Gate-drain charge ^c	Q_{gd}	$V_{GS} = 10\text{ V}$	$V_{DS} = 30\text{ V}, I_D = 1\text{ A}$	N-Ch 1	-	0.9	-	nC	
		$V_{GS} = 10\text{ V}$	$V_{DS} = 30\text{ V}, I_D = 2\text{ A}$	N-Ch 2	-	2.1	-		
Gate resistance	R_g	$f = 1\text{ MHz}$			N-Ch 1	0.7	1.47	2.2	Ω
					N-Ch 2	0.3	0.62	0.95	



SPECIFICATIONS (T _C = 25 °C, unless otherwise noted)							
PARAMETER	SYMBOL	TEST CONDITIONS	MIN.	TYP.	MAX.	UNIT	
Dynamic ^b							
Turn-on delay time ^c	t _{d(on)}	V _{DD} = 30 V, R _L = 30 Ω, I _D ≅ 1 A, V _{GEN} = 10 V, R _g = 1 Ω	N-Ch 1	-	9	15	ns
		V _{DD} = 30 V, R _L = 15 Ω, I _D ≅ 2 A, V _{GEN} = 10 V, R _g = 1 Ω	N-Ch 2	-	13	20	
Rise time ^c	t _r	V _{DD} = 30 V, R _L = 30 Ω, I _D ≅ 1 A, V _{GEN} = 10 V, R _g = 1 Ω	N-Ch 1	-	3	5	
		V _{DD} = 30 V, R _L = 15 Ω, I _D ≅ 2 A, V _{GEN} = 10 V, R _g = 1 Ω	N-Ch 2	-	3	5	
Turn-off delay time ^c	t _{d(off)}	V _{DD} = 30 V, R _L = 30 Ω, I _D ≅ 1 A, V _{GEN} = 10 V, R _g = 1 Ω	N-Ch 1	-	15	25	
		V _{DD} = 30 V, R _L = 15 Ω, I _D ≅ 2 A, V _{GEN} = 10 V, R _g = 1 Ω	N-Ch 2	-	23	35	
Fall time ^c	t _f	V _{DD} = 30 V, R _L = 30 Ω, I _D ≅ 1 A, V _{GEN} = 10 V, R _g = 1 Ω	N-Ch 1	-	10	15	
		V _{DD} = 30 V, R _L = 15 Ω, I _D ≅ 2 A, V _{GEN} = 10 V, R _g = 1 Ω	N-Ch 2	-	10	15	
Source-Drain Diode Ratings and Characteristics ^b							
Pulsed current ^a	I _{SM}		N-Ch 1	-	-	30	A
			N-Ch 2	-	-	70	
Forward voltage	V _{SD}	I _F = 2 A, V _{GS} = 0 V	N-Ch 1	-	0.81	1.2	V
		I _F = 5 A, V _{GS} = 0 V	N-Ch 2	-	0.80	1.2	
Body diode reverse recovery time	t _{rr}	I _F = 2 A, di/dt = 100 A/μs	N-Ch 1	-	24	50	ns
		I _F = 3 A, di/dt = 100 A/μs	N-Ch 2	-	36	75	
Body diode reverse recovery charge	Q _{rr}	I _F = 2 A, di/dt = 100 A/μs	N-Ch 1	-	17	35	nC
		I _F = 3 A, di/dt = 100 A/μs	N-Ch 2	-	30	60	
Reverse recovery fall time	t _a	I _F = 2 A, di/dt = 100 A/μs	N-Ch 1	-	12	-	ns
		I _F = 3 A, di/dt = 100 A/μs	N-Ch 2	-	19	-	
Reverse recovery rise time	t _b	I _F = 2 A, di/dt = 100 A/μs	N-Ch 1	-	12	-	
		I _F = 3 A, di/dt = 100 A/μs	N-Ch 2	-	17	-	
Body diode peak reverse recovery current	I _{RM(REC)}	I _F = 2 A, di/dt = 100 A/μs	N-Ch 1	-	-1.3	-	A
		I _F = 3 A, di/dt = 100 A/μs	N-Ch 2	-	-1.6	-	

Notes

- a. Pulse test; pulse width ≤ 300 μs, duty cycle ≤ 2 %
b. Guaranteed by design, not subject to production testing
c. Independent of operating temperature

Stresses beyond those listed under "Absolute Maximum Ratings" may cause permanent damage to the device. These are stress ratings only, and functional operation of the device at these or any other conditions beyond those indicated in the operational sections of the specifications is not implied. Exposure to absolute maximum rating conditions for extended periods may affect device reliability.

N-CHANNEL 1 TYPICAL CHARACTERISTICS ($T_A = 25\text{ }^\circ\text{C}$, unless otherwise noted)

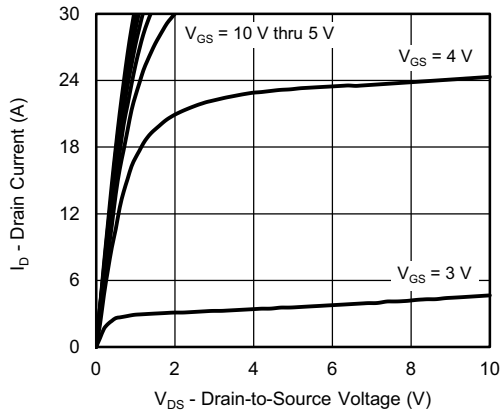

Output Characteristics

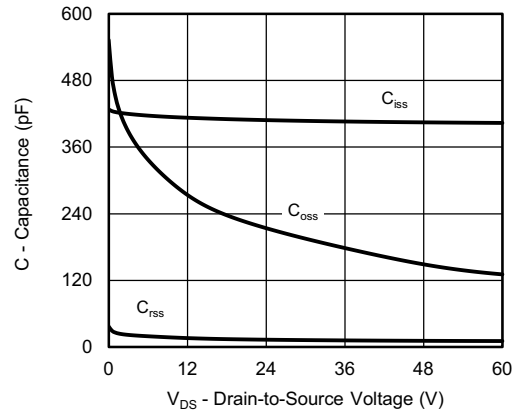

Capacitance

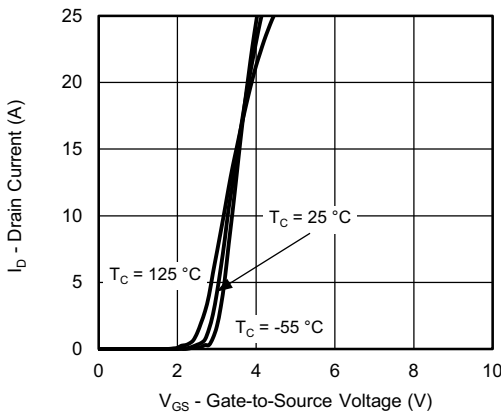

Transfer Characteristics

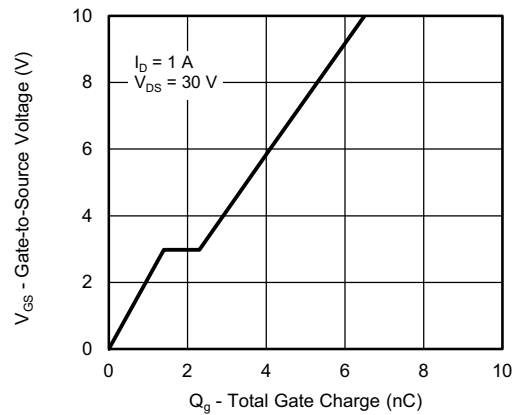

Gate Charge

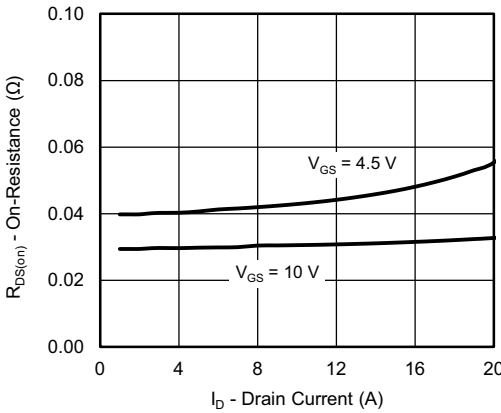

On-Resistance vs. Drain Current

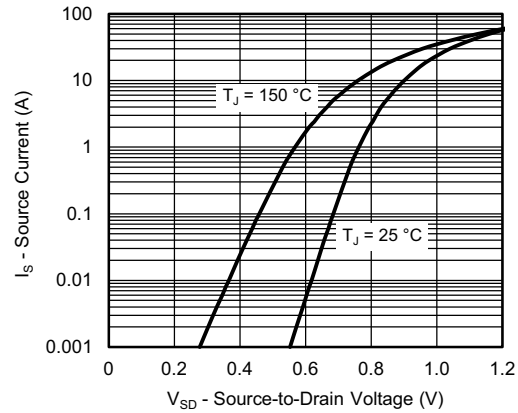

Source Drain Diode Forward Voltage

N-CHANNEL 1 TYPICAL CHARACTERISTICS ($T_A = 25\text{ }^\circ\text{C}$, unless otherwise noted)

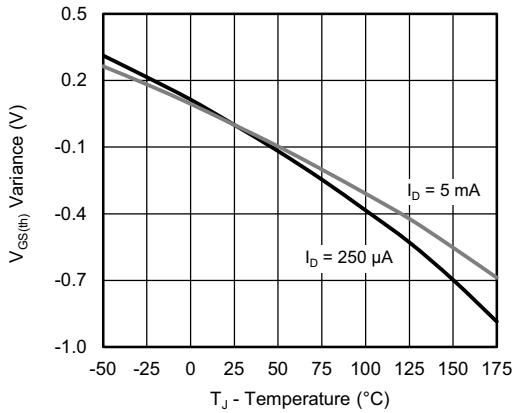

Threshold Voltage

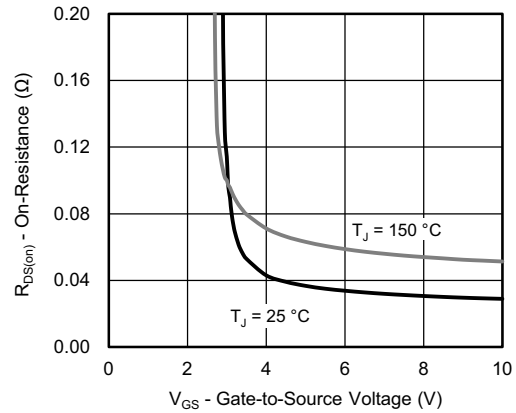

On-Resistance vs. Gate-to-Source Voltage

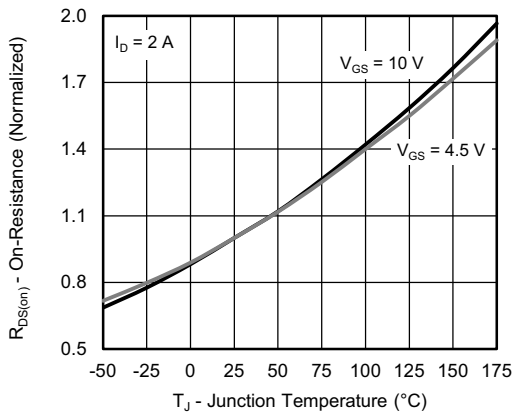

On-Resistance vs. Junction Temperature

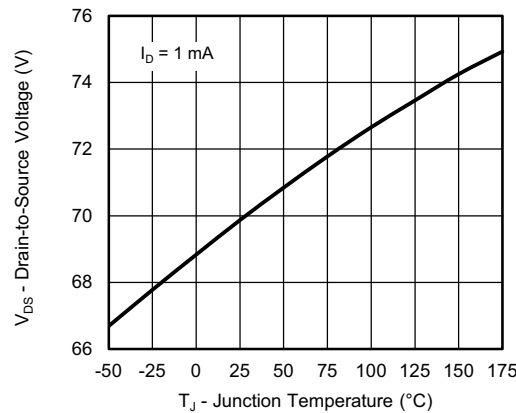

Drain Source Breakdown vs. Junction Temperature

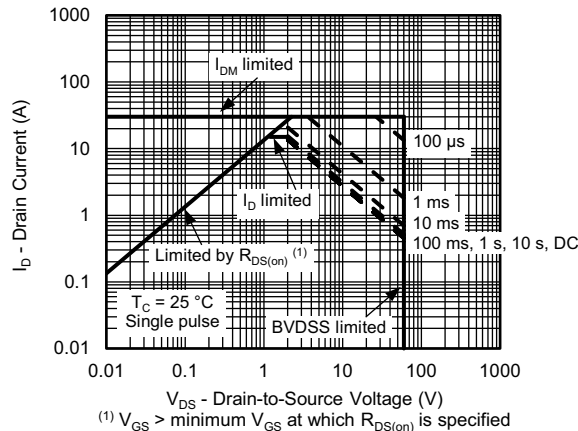

Safe Operating Area

N-CHANNEL 1 TYPICAL CHARACTERISTICS ($T_A = 25\text{ }^\circ\text{C}$, unless otherwise noted)

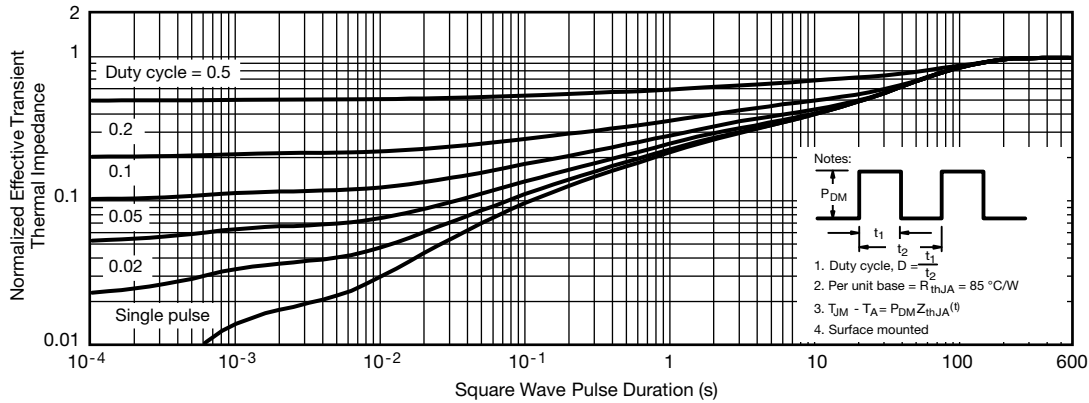

Normalized Thermal Transient Impedance, Junction-to-Ambient

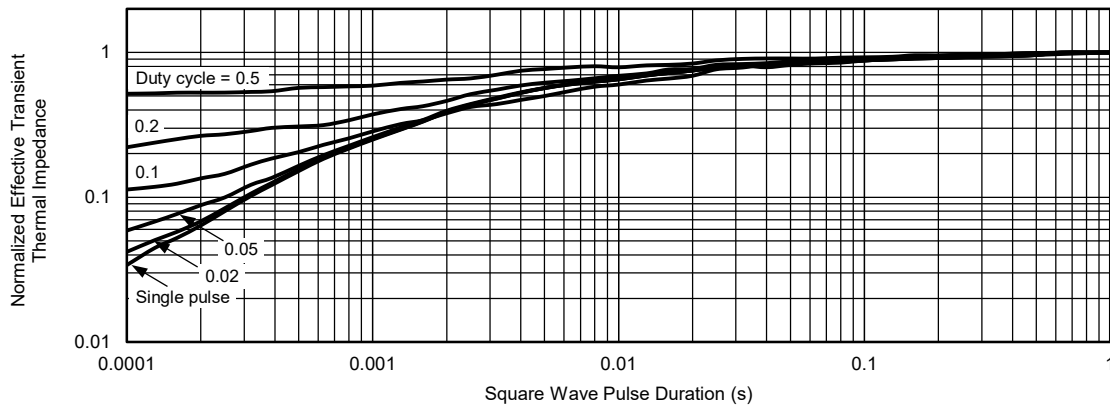

Normalized Thermal Transient Impedance, Junction-to-Case

Note

- The characteristics shown in the graph:
 - Normalized Transient Thermal Impedance Junction-to-Ambient ($25\text{ }^\circ\text{C}$) is given for general guidelines only to enable the user to get a "ball park" indication of part capabilities. The data are extracted from single pulse transient thermal impedance characteristics which are developed from empirical measurements. The latter is valid for the part mounted on printed circuit board - FR4, size 1" x 1" x 0.062", double sided with 2 oz. copper, 100 % on both sides. The part capabilities can widely vary depending on actual application parameters and operating conditions



N-CHANNEL 2 TYPICAL CHARACTERISTICS ($T_A = 25\text{ }^\circ\text{C}$, unless otherwise noted)

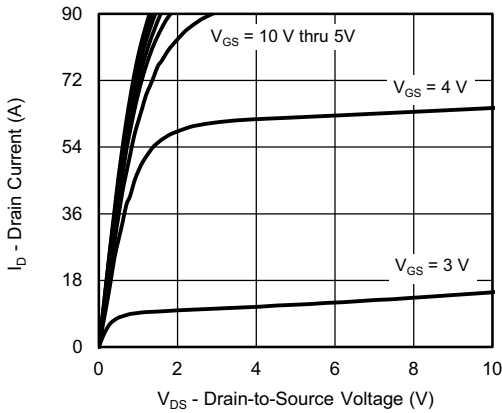

Output Characteristics

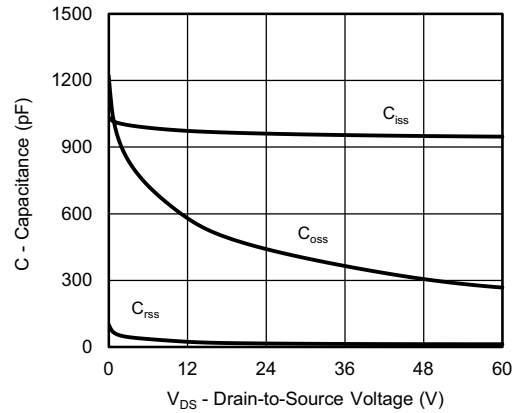

Capacitance

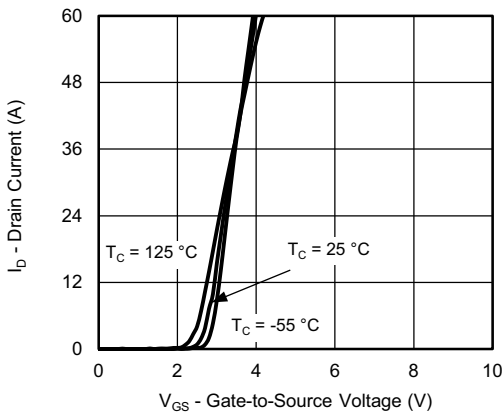

Transfer Characteristics

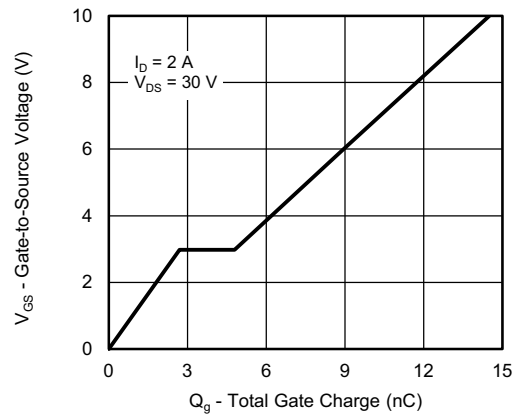

Gate Charge

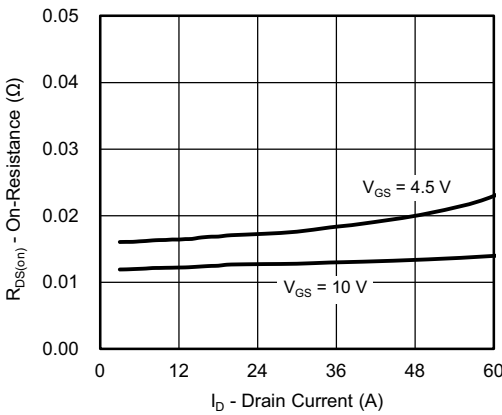

On-Resistance vs. Drain Current

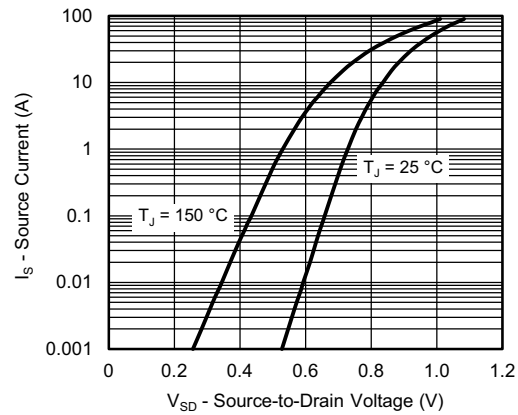

Source Drain Diode Forward Voltage

N-CHANNEL 2 TYPICAL CHARACTERISTICS ($T_A = 25\text{ }^\circ\text{C}$, unless otherwise noted)

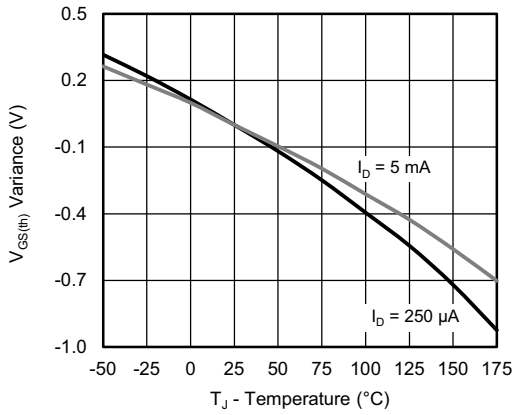

Threshold Voltage

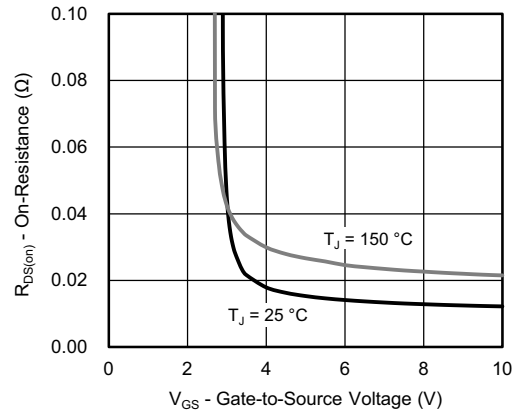

On-Resistance vs. Gate-to-Source Voltage

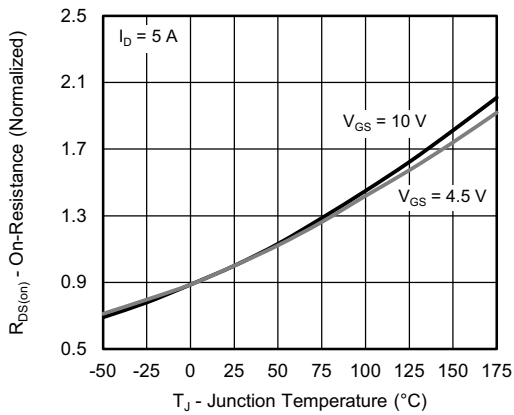

On-Resistance vs. Junction Temperature

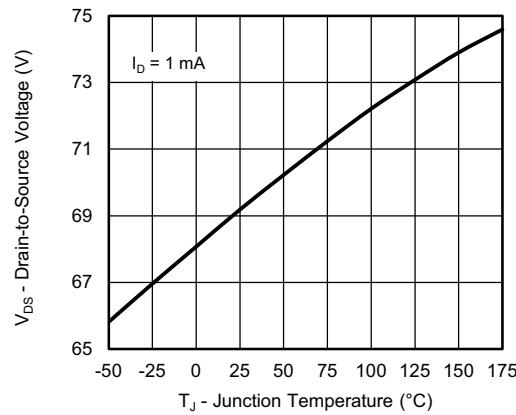

Drain Source Breakdown vs. Junction Temperature

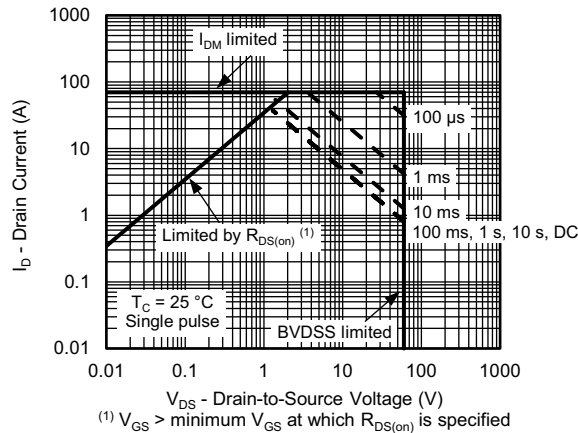

⁽¹⁾ $V_{GS} >$ minimum V_{GS} at which $R_{DS(on)}$ is specified

Safe Operating Area

N-CHANNEL 2 TYPICAL CHARACTERISTICS ($T_A = 25\text{ }^\circ\text{C}$, unless otherwise noted)

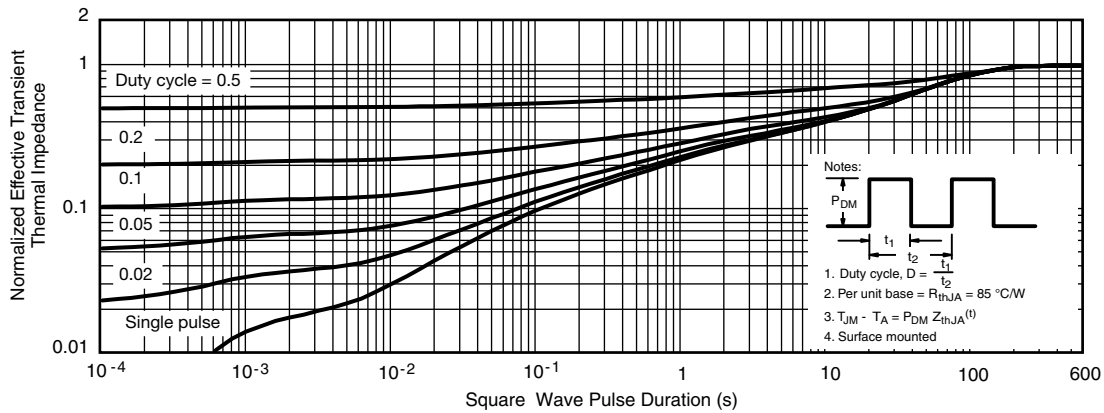

Normalized Thermal Transient Impedance, Junction-to-Ambient

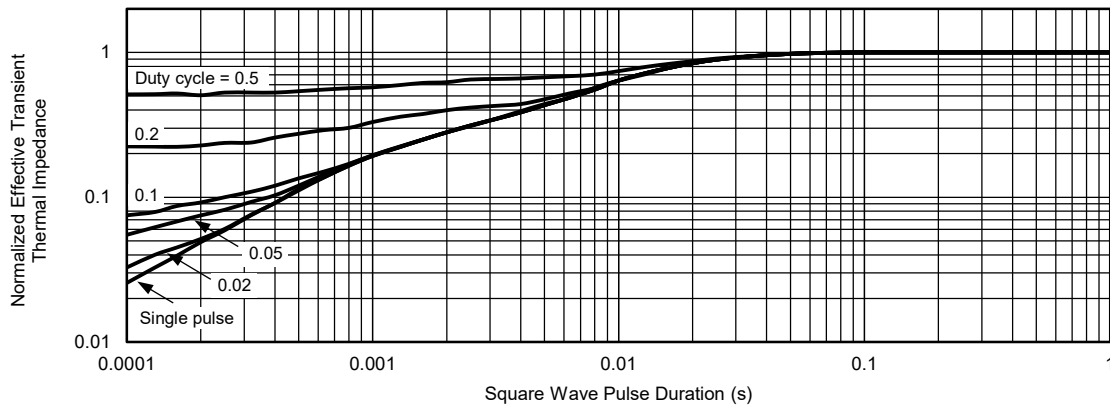

Normalized Thermal Transient Impedance, Junction-to-Case

Note

- The characteristics shown in the graph:
 - Normalized Transient Thermal Impedance Junction-to-Ambient ($25\text{ }^\circ\text{C}$) is given for general guidelines only to enable the user to get a "ball park" indication of part capabilities. The data are extracted from single pulse transient thermal impedance characteristics which are developed from empirical measurements. The latter is valid for the part mounted on printed circuit board - FR4, size 1" x 1" x 0.062", double sided with 2 oz. copper, 100 % on both sides. The part capabilities can widely vary depending on actual application parameters and operating conditions

Vishay Siliconix maintains worldwide manufacturing capability. Products may be manufactured at one of several qualified locations. Reliability data for Silicon Technology and Package Reliability represent a composite of all qualified locations. For related documents such as package / tape drawings, part marking, and reliability data, see www.vishay.com/ppg?75504.



PowerPAK[®] SO-8L Assymmetric Case Outline

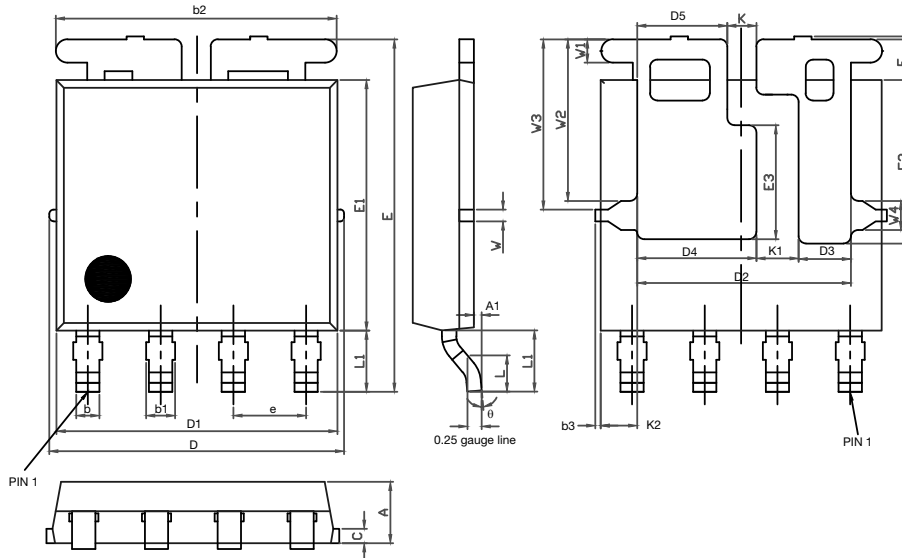

DIM.	MILLIMETERS			INCHES		
	MIN.	NOM.	MAX.	MIN.	NOM.	MAX.
A	1.00	1.07	1.14	0.039	0.042	0.045
A1	0.00	0.06	0.13	0.000	0.003	0.005
b	0.33	0.41	0.48	0.013	0.016	0.019
b1	0.44	0.51	0.58	0.017	0.020	0.023
b2	4.80	4.90	5.00	0.189	0.193	0.197
b3	0.04	0.12	0.20	0.002	0.005	0.008
c	0.20	0.25	0.30	0.008	0.010	0.012
D	5.00	5.13	5.25	0.197	0.202	0.207
D1	4.80	4.90	5.00	0.189	0.193	0.197
D2	3.63	3.73	3.83	0.143	0.147	0.151
D3	0.81	0.91	1.01	0.032	0.036	0.040
D4	1.98	2.08	2.18	0.078	0.082	0.086
D5	1.47	1.57	1.67	0.058	0.062	0.066
e	1.20	1.27	1.34	0.047	0.050	0.053
E	6.05	6.15	6.25	0.238	0.242	0.246
E1	4.27	4.37	4.47	0.168	0.172	0.176
E2	2.75	2.85	2.95	0.108	0.112	0.116
E3	1.89	1.99	2.09	0.074	0.078	0.082
F	0.05	0.12	0.19	0.002	0.005	0.007
L	0.62	0.72	0.82	0.024	0.028	0.032
L1	0.92	1.07	1.22	0.036	0.042	0.048
K	0.41	0.51	0.61	0.016	0.020	0.024
K1	0.64	0.74	0.84	0.025	0.029	0.033
K2	0.54	0.64	0.74	0.021	0.025	0.029
W	0.13	0.23	0.33	0.005	0.009	0.013
W1	0.31	0.41	0.51	0.012	0.016	0.020
W2	2.72	2.82	2.92	0.107	0.111	0.115
W3	2.86	2.96	3.06	0.113	0.117	0.120
W4	0.41	0.51	0.61	0.016	0.020	0.024
θ	5°	10°	12°	5°	10°	12°

DWG: 6009

Note

- Millimeters will govern



Disclaimer

ALL PRODUCT, PRODUCT SPECIFICATIONS AND DATA ARE SUBJECT TO CHANGE WITHOUT NOTICE TO IMPROVE RELIABILITY, FUNCTION OR DESIGN OR OTHERWISE.

Vishay Intertechnology, Inc., its affiliates, agents, and employees, and all persons acting on its or their behalf (collectively, "Vishay"), disclaim any and all liability for any errors, inaccuracies or incompleteness contained in any datasheet or in any other disclosure relating to any product.

Vishay makes no warranty, representation or guarantee regarding the suitability of the products for any particular purpose or the continuing production of any product. To the maximum extent permitted by applicable law, Vishay disclaims (i) any and all liability arising out of the application or use of any product, (ii) any and all liability, including without limitation special, consequential or incidental damages, and (iii) any and all implied warranties, including warranties of fitness for particular purpose, non-infringement and merchantability.

Statements regarding the suitability of products for certain types of applications are based on Vishay's knowledge of typical requirements that are often placed on Vishay products in generic applications. Such statements are not binding statements about the suitability of products for a particular application. It is the customer's responsibility to validate that a particular product with the properties described in the product specification is suitable for use in a particular application. Parameters provided in datasheets and / or specifications may vary in different applications and performance may vary over time. All operating parameters, including typical parameters, must be validated for each customer application by the customer's technical experts. Product specifications do not expand or otherwise modify Vishay's terms and conditions of purchase, including but not limited to the warranty expressed therein.

Hyperlinks included in this datasheet may direct users to third-party websites. These links are provided as a convenience and for informational purposes only. Inclusion of these hyperlinks does not constitute an endorsement or an approval by Vishay of any of the products, services or opinions of the corporation, organization or individual associated with the third-party website. Vishay disclaims any and all liability and bears no responsibility for the accuracy, legality or content of the third-party website or for that of subsequent links.

Vishay products are not designed for use in life-saving or life-sustaining applications or any application in which the failure of the Vishay product could result in personal injury or death unless specifically qualified in writing by Vishay. Customers using or selling Vishay products not expressly indicated for use in such applications do so at their own risk. Please contact authorized Vishay personnel to obtain written terms and conditions regarding products designed for such applications.

No license, express or implied, by estoppel or otherwise, to any intellectual property rights is granted by this document or by any conduct of Vishay. Product names and markings noted herein may be trademarks of their respective owners.