

Darlington Complementary Silicon Power Transistors

BDX33B, BDX33C (NPN) BDX34B, BDX34C (PNP)

These devices are designed for general purpose and low speed switching applications.

Features

- High DC Current Gain – $h_{FE} = 2500$ (typ.) at $I_C = 4.0$
- Collector–Emitter Sustaining Voltage at 100 mAdc
 $V_{CE(sus)} = 80$ Vdc (min) – BDX33B, BDX334B
 $= 100$ Vdc (min) – BDX33C, BDX334C
- Low Collector–Emitter Saturation Voltage
 $V_{CE(sat)} = 2.5$ Vdc (max) at $I_C = 3.0$ Adc
– BDX33B, 33C/34B, 34C
- Monolithic Construction with Build–In Base–Emitter Shunt Resistors
- These Devices are Pb–Free and are RoHS Compliant*

MAXIMUM RATINGS

Rating	Symbol	Value	Unit
Collector–Emitter Voltage BDX33B, BDX34B BDX33C, BDX34C	V_{CEO}	80 100	Vdc
Collector–Base Voltage BDX33B, BDX34B BDX33C, BDX34C	V_{CB}	80 100	Vdc
Emitter–Base Voltage	V_{EB}	5.0	Vdc
Collector Current Continuous Peak	I_C	10 15	Adc
Base Current	I_B	0.25	Adc
Total Device Dissipation @ $T_C = 25^\circ\text{C}$ Derate above 25°C	P_D	70 0.56	W W/ $^\circ\text{C}$
Operating and Storage Junction Temperature Range	T_J, T_{stg}	–65 to +150	$^\circ\text{C}$

Stresses exceeding those listed in the Maximum Ratings table may damage the device. If any of these limits are exceeded, device functionality should not be assumed, damage may occur and reliability may be affected.

THERMAL CHARACTERISTICS

Characteristics	Symbol	Max	Unit
Thermal Resistance, Junction–to–Case	$R_{\theta JC}$	1.78	$^\circ\text{C}/\text{W}$

DARLINGTON 10 AMPERE COMPLEMENTARY SILICON POWER TRANSISTORS 80–100 VOLTS, 65 WATTS

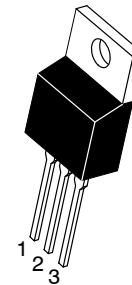

TO-220
CASE 221A
STYLE 1

MARKING DIAGRAM



BDX3xy = Device Code
x = 3 or 4
y = B or C
A = Assembly Location
Y = Year
WW = Work Week
G = Pb–Free Package

ORDERING INFORMATION

See detailed ordering and shipping information in the package dimensions section on page 5 of this data sheet.

NOTE: Some of the devices on this data sheet have been **DISCONTINUED**. Please refer to the table on page 5.

*For additional information on our Pb–Free strategy and soldering details, please download the onsemi Soldering and Mounting Techniques Reference Manual, SOLDERRM/D.

BDX33B, BDX33C (NPN) BDX34B, BDX34C (PNP)

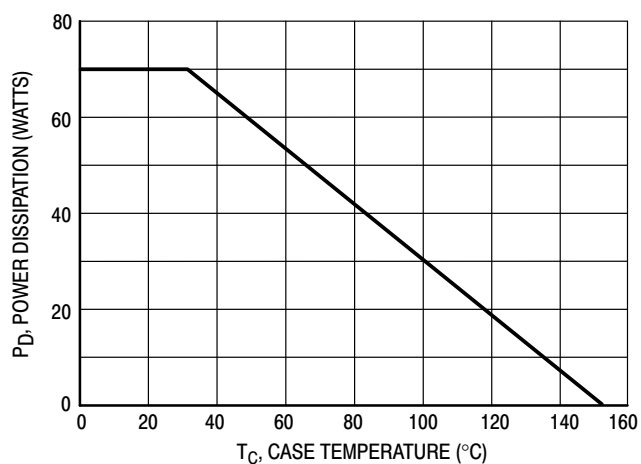

Figure 1. Power Derating

ELECTRICAL CHARACTERISTICS (T_C = 25°C unless otherwise noted)

Characteristic	Symbol	Min	Max	Unit	
OFF CHARACTERISTICS					
Collector-Emitter Sustaining Voltage (Note 1) (I _C = 100 mAdc, I _B = 0)	BDX33B/BDX34B BDX33C/BDX34C	V _{CEO(sus)}	80 100	- -	Vdc
Collector-Emitter Sustaining Voltage (Note 1) (I _C = 100 mAdc, I _B = 0, R _{BE} = 100)	BDX33B/BDX34B BDX33C/BDX33C	V _{CER(sus)}	80 100	- -	Vdc
Collector-Emitter Sustaining Voltage (Note 1) (I _C = 100 mAdc, I _B = 0, V _{BE} = 1.5 Vdc)	BDX33B/BDX34B BDX33C/BDX34C	V _{CEX(sus)}	80 100	- -	Vdc
Collector Cutoff Current (V _{CE} = 1/2 rated V _{CEO} , I _B = 0)	T _C = 25°C T _C = 100°C	I _{CEO}	- -	0.5 10	mAdc
Collector Cutoff Current (V _{CB} = rated V _{CBO} , I _E = 0)	T _C = 25°C T _C = 100°C	I _{CBO}	- -	1.0 5.0	mAdc
Emitter Cutoff Current (V _{BE} = 5.0 Vdc, I _C = 0)		I _{EBO}	-	10	mAdc
ON CHARACTERISTICS					
DC Current Gain (Note 1) (I _C = 3.0 Adc, V _{CE} = 3.0 Vdc)	BDX33B, 33C/34B, 34C	h _{FE}	750	-	-
Collector-Emitter Saturation Voltage (I _C = 3.0 Adc, I _B = 6.0 mAdc)	BDX33B, 33C/34B, 34C	V _{CE(sat)}	-	2.5	Vdc
Base-Emitter On Voltage (I _C = 3.0 Adc, V _{CE} = 3.0 Vdc)	BDX33B, 33C/34B, 34C	V _{BE(on)}	-	2.5	Vdc
Diode Forward Voltage (I _C = 8.0 Adc)		V _F	-	4.0	Vdc

Product parametric performance is indicated in the Electrical Characteristics for the listed test conditions, unless otherwise noted. Product performance may not be indicated by the Electrical Characteristics if operated under different conditions.

1. Pulse Test: Pulse Width ≤ 300 μs, Duty Cycle ≤ 2.0%.
2. Pulse Test non repetitive: Pulse Width = 0.25 seconds.

BDX33B, BDX33C (NPN) BDX34B, BDX34C (PNP)

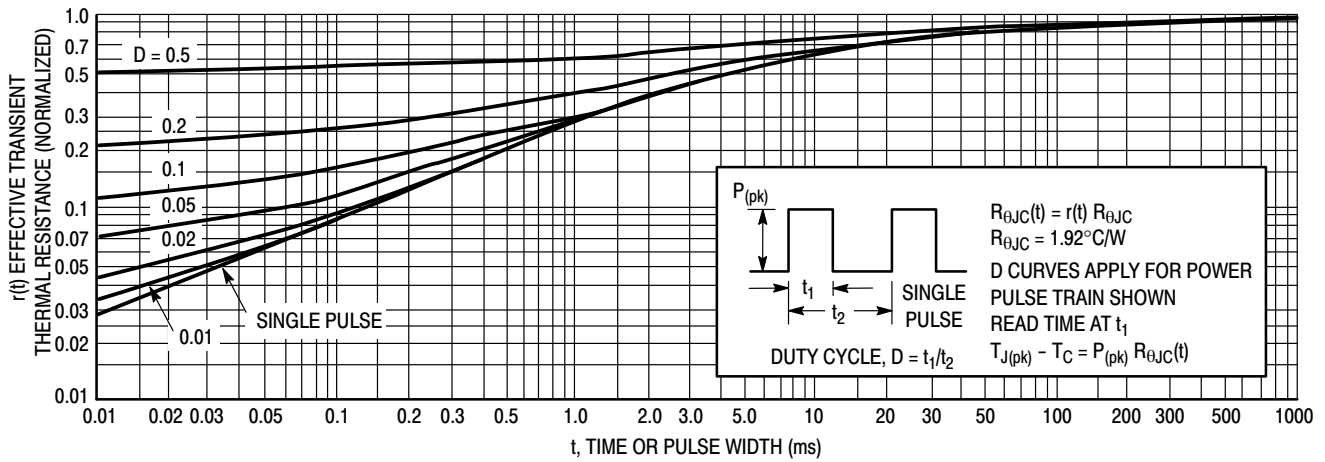

Figure 1. Thermal Response

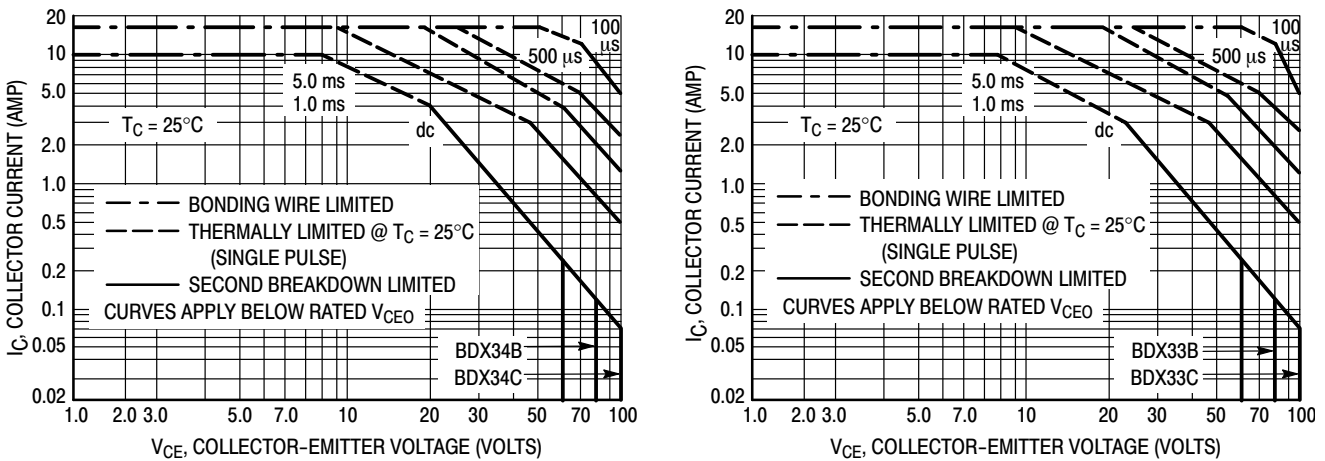

Figure 2. Active-Region Safe Operating Area

There are two limitations on the power handling ability of a transistor: average junction temperature and second breakdown. Safe operating area curves indicate $I_C - V_{CE}$ limits of the transistor that must be observed for reliable operation, i.e., the transistor must not be subjected to greater dissipation than the curves indicate. The data of Figure 3 is based on

$T_{J(pk)} = 150^\circ\text{C}$; T_C is variable depending on conditions. Second breakdown pulse limits are valid for duty cycles to 10% provided $T_{J(pk)} = 150^\circ\text{C}$. $T_{J(pk)}$ may be calculated from the data in Figure 4. At high case temperatures, thermal limitations will reduce the power that can be handled to values less than the limitations imposed by second breakdown.

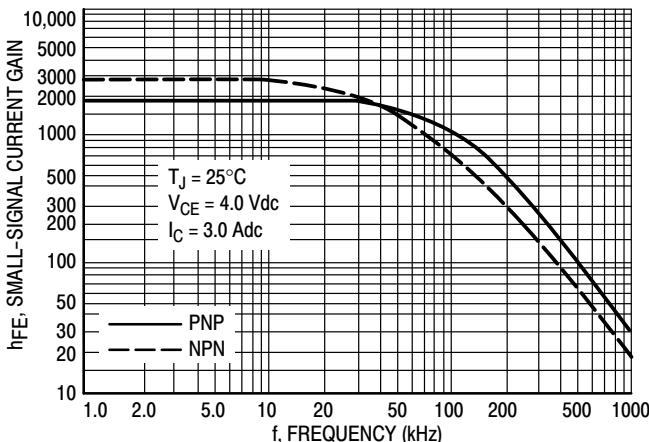

Figure 3. Small-Signal Current Gain

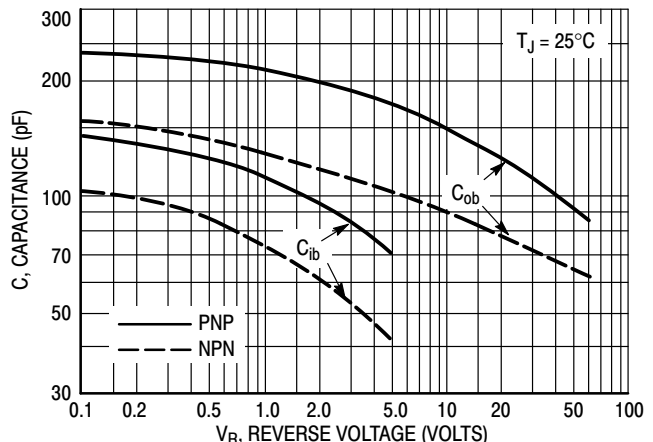

Figure 4. Capacitance

BDX33B, BDX33C (NPN) BDX34B, BDX34C (PNP)

NPN
BDX33B, 33C

PNP
BDX34B, 34C

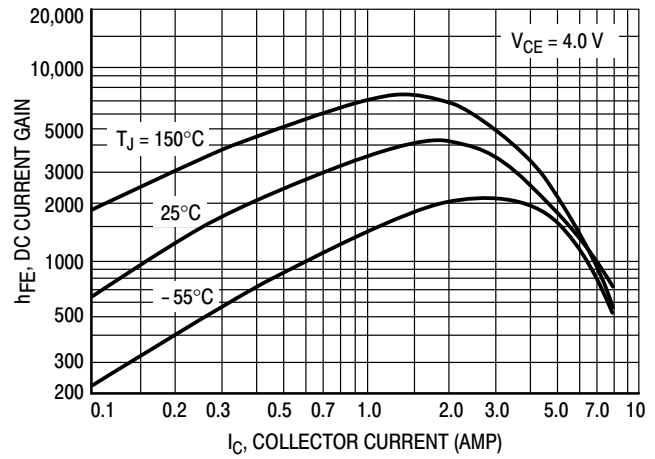
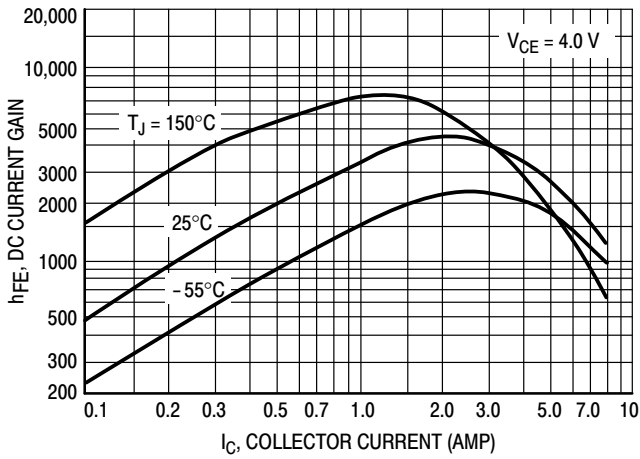

Figure 5. DC Current Gain

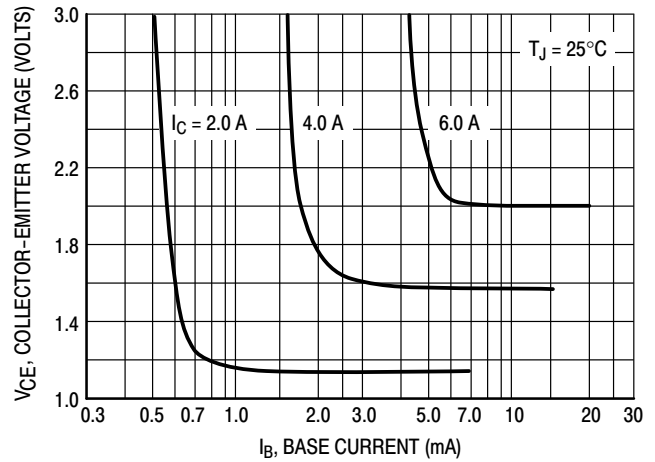
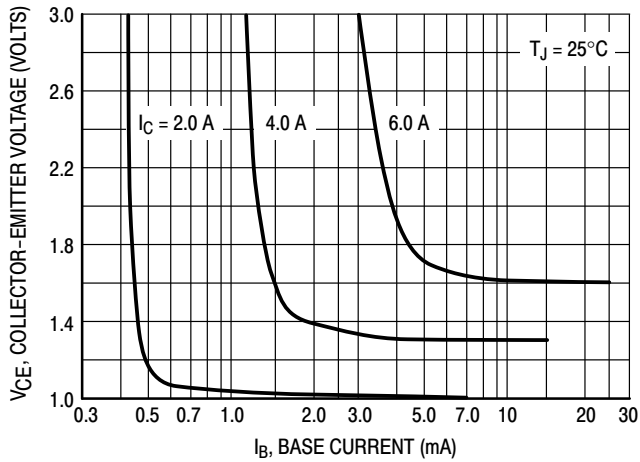

Figure 6. Collector Saturation Region

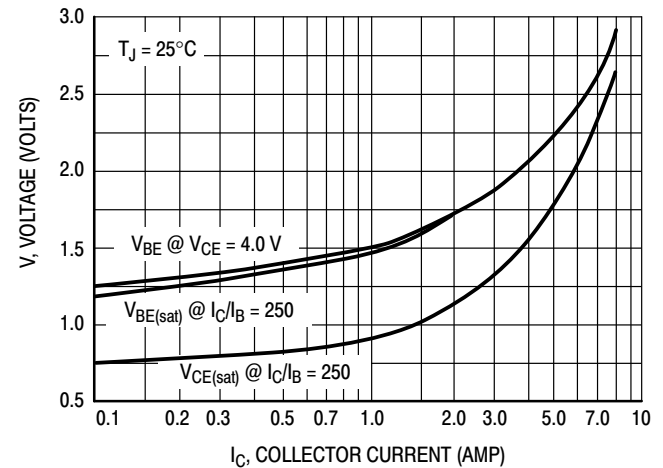
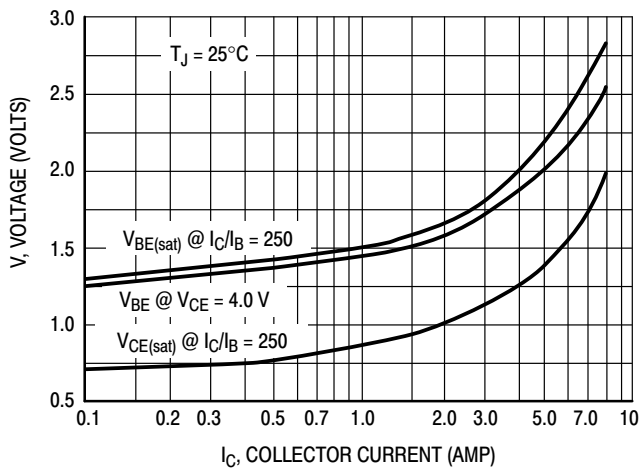

Figure 7. "On" Voltages

BDX33B, BDX33C (NPN) BDX34B, BDX34C (PNP)

ORDERING INFORMATION

Device	Package	Shipping†
BDX33BG	TO-220 (Pb-Free)	50 Units / Rail
BDX33CG	TO-220 (Pb-Free)	50 Units / Rail

DISCONTINUED (Note NO TAG)

BDX34BG	TO-220 (Pb-Free)	50 Units / Rail
BDX34CG	TO-220 (Pb-Free)	50 Units / Rail

†For information on tape and reel specifications, including part orientation and tape sizes, please refer to our Tape and Reel Packaging Specifications Brochure, BRD8011/D.

3. **DISCONTINUED:** These devices are not recommended for new design. Please contact your **onsemi** representative for information. The most current information on these devices may be available on www.onsemi.com.

TO-220
CASE 221A
ISSUE AK

DATE 13 JAN 2022

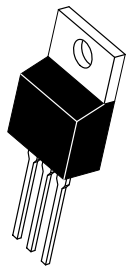

SCALE 1:1

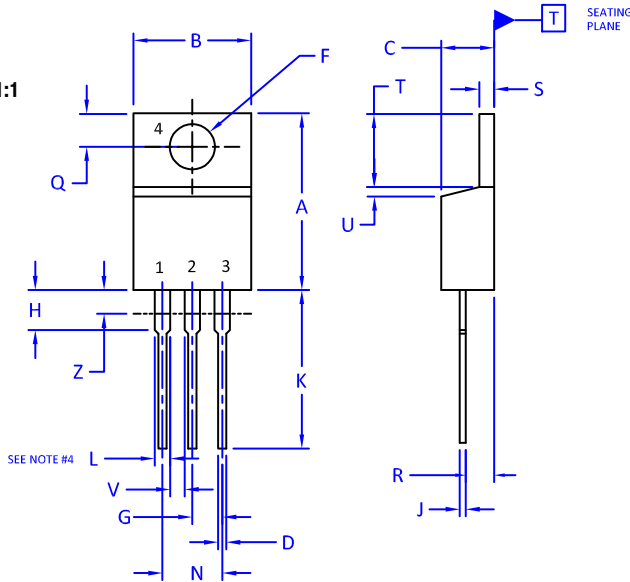

NOTES:

1. DIMENSIONING AND TOLERANCING PER ANSI Y14.5M, 2009.
2. CONTROLLING DIMENSION: INCHES
3. DIMENSION Z DEFINES A ZONE WHERE ALL BODY AND LEAD IRREGULARITIES ARE ALLOWED.
4. MAX WIDTH FOR F102 DEVICE = 1.35MM

DIM	INCHES		MILLIMETERS	
	MIN.	MAX.	MIN.	MAX.
A	0.570	0.620	14.48	15.75
B	0.380	0.415	9.66	10.53
C	0.160	0.190	4.07	4.83
D	0.025	0.038	0.64	0.96
F	0.142	0.161	3.60	4.09
G	0.095	0.105	2.42	2.66
H	0.110	0.161	2.80	4.10
J	0.014	0.024	0.36	0.61
K	0.500	0.562	12.70	14.27
L	0.045	0.060	1.15	1.52
N	0.190	0.210	4.83	5.33
Q	0.100	0.120	2.54	3.04
R	0.080	0.110	2.04	2.79
S	0.045	0.055	1.15	1.41
T	0.235	0.255	5.97	6.47
U	0.000	0.050	0.00	1.27
V	0.045	----	1.15	---
Z	----	0.080	---	2.04

STYLE 1:

- PIN 1. BASE
- 2. COLLECTOR
- 3. EMITTER
- 4. COLLECTOR

STYLE 2:

- PIN 1. BASE
- 2. EMITTER
- 3. COLLECTOR
- 4. EMITTER

STYLE 3:

- PIN 1. CATHODE
- 2. ANODE
- 3. GATE
- 4. ANODE

STYLE 4:

- PIN 1. MAIN TERMINAL 1
- 2. MAIN TERMINAL 2
- 3. GATE
- 4. MAIN TERMINAL 2

STYLE 5:

- PIN 1. GATE
- 2. DRAIN
- 3. SOURCE
- 4. DRAIN

STYLE 6:

- PIN 1. ANODE
- 2. CATHODE
- 3. ANODE
- 4. CATHODE

STYLE 7:

- PIN 1. CATHODE
- 2. ANODE
- 3. CATHODE
- 4. ANODE

STYLE 8:

- PIN 1. CATHODE
- 2. ANODE
- 3. EXTERNAL TRIP/DELAY
- 4. ANODE

STYLE 9:

- PIN 1. GATE
- 2. COLLECTOR
- 3. EMITTER
- 4. COLLECTOR

STYLE 10:

- PIN 1. GATE
- 2. SOURCE
- 3. DRAIN
- 4. SOURCE

STYLE 11:

- PIN 1. DRAIN
- 2. SOURCE
- 3. GATE
- 4. SOURCE

STYLE 12:

- PIN 1. MAIN TERMINAL 1
- 2. MAIN TERMINAL 2
- 3. GATE
- 4. NOT CONNECTED

DOCUMENT NUMBER:	98ASB42148B	Electronic versions are uncontrolled except when accessed directly from the Document Repository. Printed versions are uncontrolled except when stamped "CONTROLLED COPY" in red.
DESCRIPTION:	TO-220	PAGE 1 OF 1

onsemi and ONSEMI are trademarks of Semiconductor Components Industries, LLC dba onsemi or its subsidiaries in the United States and/or other countries. onsemi reserves the right to make changes without further notice to any products herein. onsemi makes no warranty, representation or guarantee regarding the suitability of its products for any particular purpose, nor does onsemi assume any liability arising out of the application or use of any product or circuit, and specifically disclaims any and all liability, including without limitation special, consequential or incidental damages. onsemi does not convey any license under its patent rights nor the rights of others.

onsemi, **Onsemi**, and other names, marks, and brands are registered and/or common law trademarks of Semiconductor Components Industries, LLC dba "**onsemi**" or its affiliates and/or subsidiaries in the United States and/or other countries. **onsemi** owns the rights to a number of patents, trademarks, copyrights, trade secrets, and other intellectual property. A listing of **onsemi**'s product/patent coverage may be accessed at www.onsemi.com/site/pdf/Patent-Marking.pdf. **onsemi** reserves the right to make changes at any time to any products or information herein, without notice. The information herein is provided "as-is" and **onsemi** makes no warranty, representation or guarantee regarding the accuracy of the information, product features, availability, functionality, or suitability of its products for any particular purpose, nor does **onsemi** assume any liability arising out of the application or use of any product or circuit, and specifically disclaims any and all liability, including without limitation special, consequential or incidental damages. Buyer is responsible for its products and applications using **onsemi** products, including compliance with all laws, regulations and safety requirements or standards, regardless of any support or applications information provided by **onsemi**. "Typical" parameters which may be provided in **onsemi** data sheets and/or specifications can and do vary in different applications and actual performance may vary over time. All operating parameters, including "Typicals" must be validated for each customer application by customer's technical experts. **onsemi** does not convey any license under any of its intellectual property rights nor the rights of others. **onsemi** products are not designed, intended, or authorized for use as a critical component in life support systems or any FDA Class 3 medical devices or medical devices with a same or similar classification in a foreign jurisdiction or any devices intended for implantation in the human body. Should Buyer purchase or use **onsemi** products for any such unintended or unauthorized application, Buyer shall indemnify and hold **onsemi** and its officers, employees, subsidiaries, affiliates, and distributors harmless against all claims, costs, damages, and expenses, and reasonable attorney fees arising out of, directly or indirectly, any claim of personal injury or death associated with such unintended or unauthorized use, even if such claim alleges that **onsemi** was negligent regarding the design or manufacture of the part. **onsemi** is an Equal Opportunity/Affirmative Action Employer. This literature is subject to all applicable copyright laws and is not for resale in any manner.

ADDITIONAL INFORMATION

TECHNICAL PUBLICATIONS:

Technical Library: www.onsemi.com/design/resources/technical-documentation
onsemi Website: www.onsemi.com

ONLINE SUPPORT: www.onsemi.com/support

For additional information, please contact your local Sales Representative at www.onsemi.com/support/sales