

# Darlington Power Transistors

## DPAK For Surface Mount Applications

### MJD6039, NJVMJD6039T4G

Designed for general purpose power and switching such as output or driver stages in applications such as switching regulators, convertors, and power amplifiers.

#### Features

- Lead Formed for Surface Mount Applications in Plastic Sleeves (No Suffix)
- Straight Lead Version in Plastic Sleeves (“-1” Suffix)
- Monolithic Construction With Built-in Base-Emitter Shunt Resistors
- High DC Current Gain –  $h_{FE} = 2500$  (Typ) @  $I_C = 4.0$  Adc
- Epoxy Meets UL 94 V-0 @ 0.125 in
- ESD Ratings:
  - ◆ Human Body Model,  $3B > 8000$  V
  - ◆ Machine Model,  $C > 400$  V
- NJV Prefix for Automotive and Other Applications Requiring Unique Site and Control Change Requirements; AEC-Q101 Qualified and PPAP Capable
- Pb-Free Package is Available\*

#### MAXIMUM RATINGS

Rating	Symbol	Max	Unit
Collector-Emitter Voltage	$V_{CEO}$	80	Vdc
Collector-Base Voltage	$V_{CB}$	80	Vdc
Emitter-Base Voltage	$V_{EB}$	5	Vdc
Collector Current Continuous Peak	$I_C$	4 8	Adc
Base Current	$I_B$	100	mAdc
Total Power Dissipation @ $T_C = 25^\circ\text{C}$ Derate above $25^\circ\text{C}$	$P_D$	20 0.16	W W/ $^\circ\text{C}$
Total Power Dissipation (Note 2) @ $T_A = 25^\circ\text{C}$ Derate above $25^\circ\text{C}$	$P_D$	1.75 0.014	W W/ $^\circ\text{C}$
Operating and Storage Junction Temperature Range	$T_J, T_{stg}$	-65 to +150	$^\circ\text{C}$

Stresses exceeding Maximum Ratings may damage the device. Maximum Ratings are stress ratings only. Functional operation above the Recommended Operating Conditions is not implied. Extended exposure to stresses above the Recommended Operating Conditions may affect device reliability.

2. These ratings are applicable when surface mounted on the minimum pad sizes recommended.

\*For additional information on our Pb-Free strategy and soldering details, please download the **onsemi** Soldering and Mounting Techniques Reference Manual, SOLDERRM/D.

## SILICON POWER TRANSISTORS 4 AMPERES, 80 VOLTS, 20 WATTS



DPAK  
CASE 369C  
STYLE 1

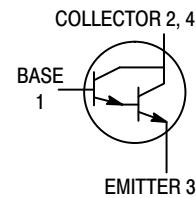

#### MARKING DIAGRAM

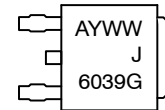

A = Assembly Location  
 Y = Year  
 WW = Work Week  
 J6039 = Device Code  
 G = Pb-Free Package

#### ORDERING INFORMATION

Device	Package	Shipping†
MJD6039T4G	DPAK (Pb-Free)	2500 / Tape & Reel
NJVMJD6039T4G	DPAK (Pb-Free)	2500 / Tape & Reel

#### DISCONTINUED (Note 1)

MJD6039T4	DPAK (Pb-Free)	2500 / Tape & Reel
-----------	-------------------	-----------------------

†For information on tape and reel specifications, including part orientation and tape sizes, please refer to our Tape and Reel Packaging Specifications Brochure, [BRD8011/D](#).

1. **DISCONTINUED:** This device is not recommended for new design. Please contact your **onsemi** representative for information. The most current information on this device may be available on [www.onsemi.com](http://www.onsemi.com).

# MJD6039, NJVMJD6039T4G

## THERMAL CHARACTERISTICS

Characteristic	Symbol	Max	Unit
Thermal Resistance, Junction-to-Case	$R_{\theta JC}$	6.25	$^{\circ}C/W$
Thermal Resistance, Junction-to-Ambient (Note 3)	$R_{\theta JA}$	71.4	$^{\circ}C/W$

3. These ratings are applicable when surface mounted on the minimum pad sizes recommended.

## ELECTRICAL CHARACTERISTICS ( $T_C = 25^{\circ}C$ unless otherwise noted)

Characteristic	Symbol	Min	Max	Unit
Collector-Emitter Sustaining Voltage ( $I_C = 30 \text{ mAdc}$ , $I_B = 0$ )	$V_{CE(sus)}$	80	-	Vdc
Collector-Cutoff Current ( $V_{CE} = 40 \text{ Vdc}$ , $I_B = 0$ )	$I_{CEO}$	-	10	$\mu\text{Adc}$

## ON CHARACTERISTICS (Note 4)

DC Current Gain ( $I_C = 1 \text{ Adc}$ , $V_{CE} = 4 \text{ Vdc}$ ) ( $I_C = 2 \text{ Adc}$ , $V_{CE} = 4 \text{ Vdc}$ )	$h_{FE}$	1000 500	- -	-
Collector-Emitter Saturation Voltage ( $I_C = 2 \text{ Adc}$ , $I_B = 8 \text{ mAdc}$ )	$V_{CE(sat)}$	-	2.5	Vdc
Base-Emitter On Voltage ( $I_C = 2 \text{ Adc}$ , $V_{CE} = 4 \text{ Vdc}$ )	$V_{BE(on)}$	-	2.8	Vdc

## DYNAMIC CHARACTERISTICS

Small-Signal Current Gain ( $I_C = 0.75 \text{ Adc}$ , $V_{CE} = 10 \text{ Vdc}$ , $f = 1 \text{ kHz}$ )	$h_{fe}$	25	-	-
Output Capacitance ( $V_{CB} = 10 \text{ Vdc}$ , $I_E = 0$ , $f = 0.1 \text{ MHz}$ )	$C_{ob}$	-	100	pF

4. Pulse Test: Pulse Width  $\leq 300 \mu\text{s}$ , Duty Cycle  $\leq 2\%$ .

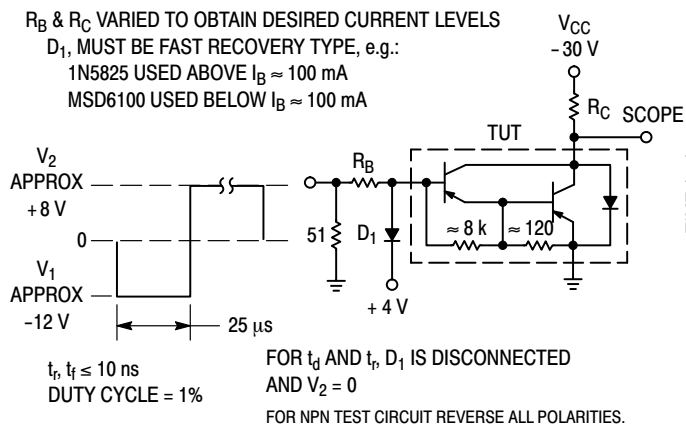

Figure 1. Switching Times Test Circuit

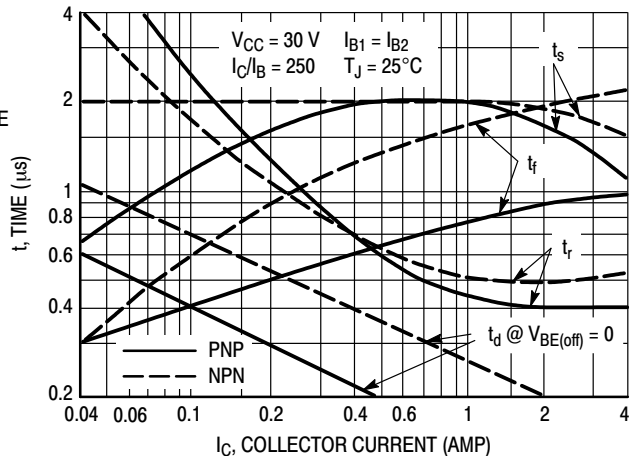

Figure 2. Switching Times

TYPICAL ELECTRICAL CHARACTERISTICS

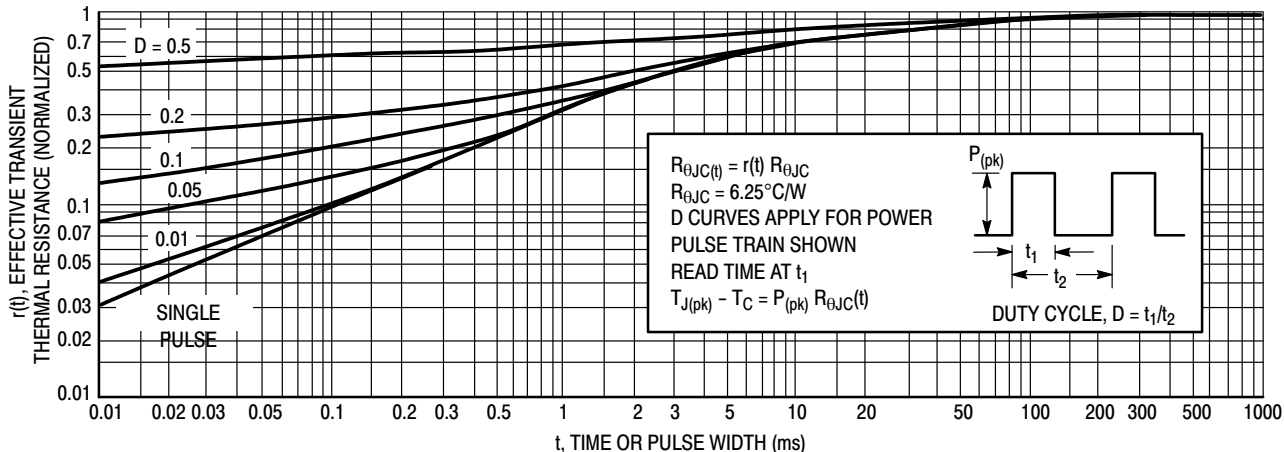

Figure 3. Thermal Response

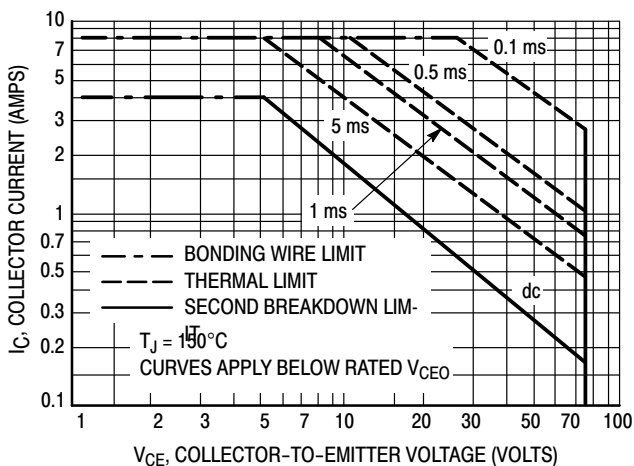

Figure 4. Maximum Rated Forward Biased Safe Operating Area

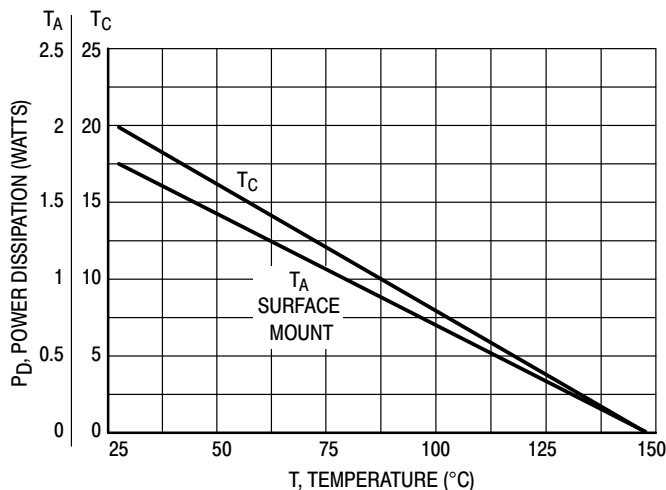

Figure 5. Power Derating

There are two limitations on the power handling ability of a transistor: average junction temperature and second breakdown. Safe operating area curves indicate  $I_C - V_{CE}$  limits of the transistor that must be observed for reliable operation; i.e., the transistor must not be subjected to greater dissipation than the curves indicate.

The data of Figures 6 and 7 is based on  $T_{J(pk)} = 150^\circ\text{C}$ ;  $T_C$  is variable depending on conditions. Second breakdown pulse limits are valid for duty cycles to 10% provided  $T_{J(pk)} < 150^\circ\text{C}$ .  $T_{J(pk)}$  may be calculated from the data in Figure 5. At high case temperatures, thermal limitations will reduce the power that can be handled to values less than the limitations imposed by second breakdown.

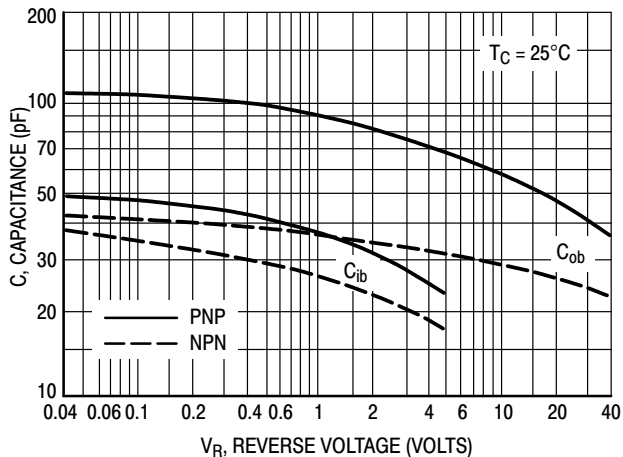

Figure 6. Capacitance

TYPICAL ELECTRICAL CHARACTERISTICS

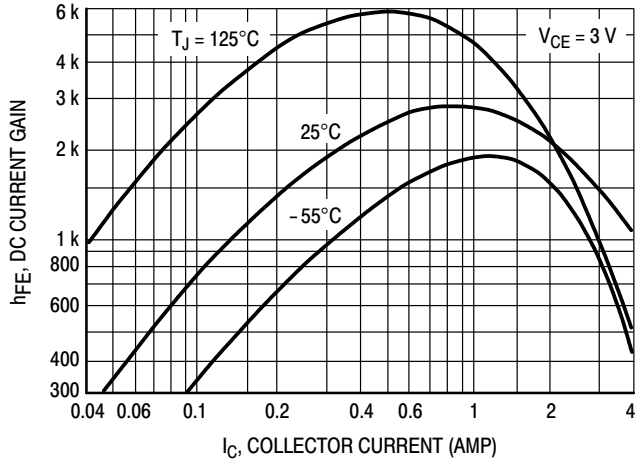

Figure 7. DC Current Gain

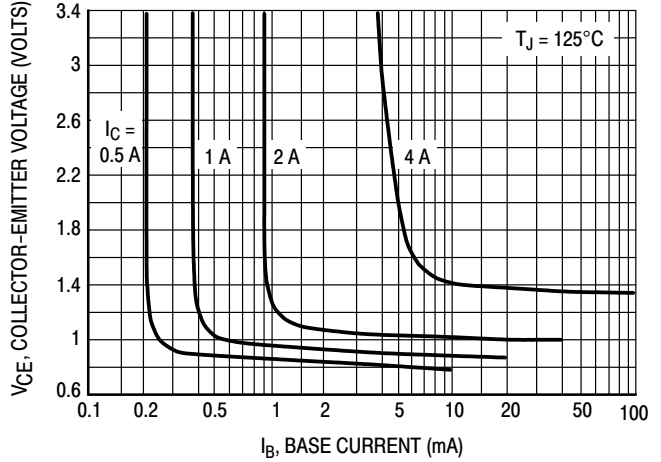

Figure 8. Collector Saturation Region

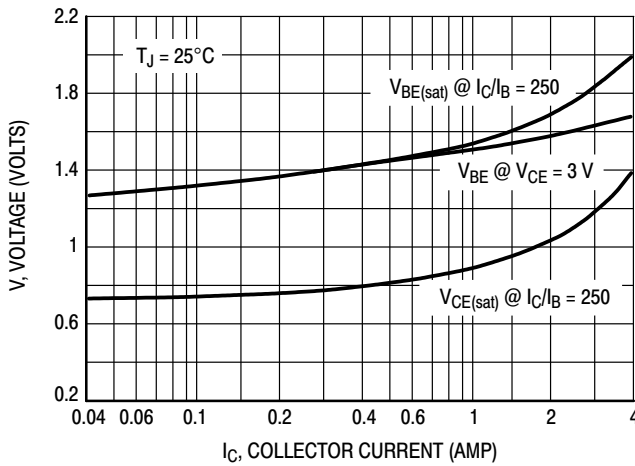

Figure 9. "On" Voltages

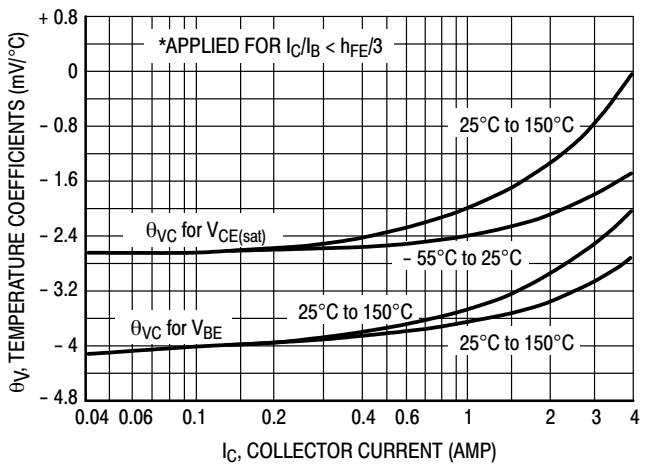

Figure 10. Temperature Coefficients

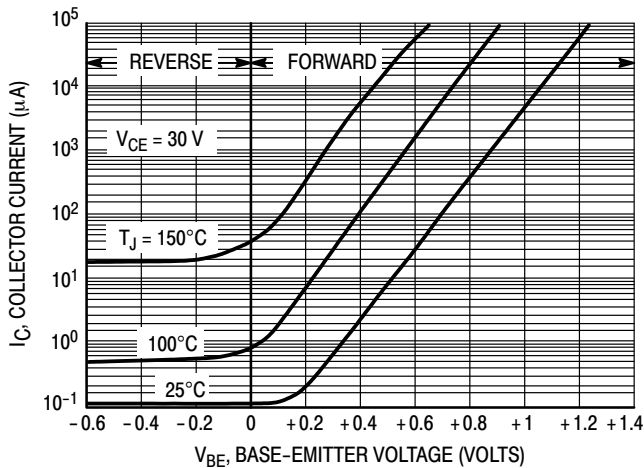

Figure 11. Collector Cut-Off Region

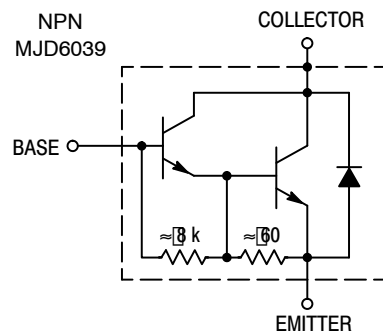
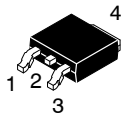

Figure 12. Darlington Schematic



### DPAK (SINGLE GAUGE) CASE 369C ISSUE G

DATE 31 MAY 2023

SCALE 1:1

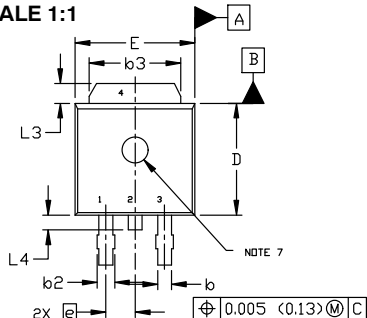

TOP VIEW

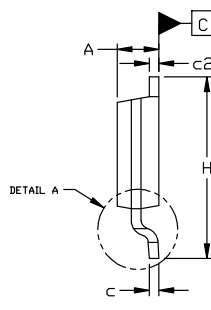

SIDE VIEW

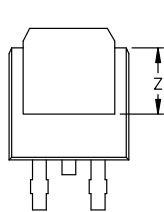

BOTTOM VIEW

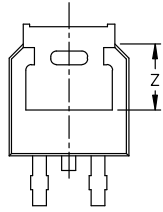

BOTTOM VIEW

ALTERNATE CONSTRUCTIONS

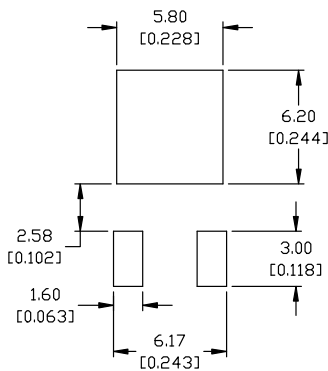

RECOMMENDED MOUNTING FOOTPRINT\*

\*FOR ADDITIONAL INFORMATION ON OUR Pb-FREE STRATEGY AND SOLDERING DETAILS, PLEASE DOWNLOAD THE ON SEMICONDUCTOR SOLDERING AND MOUNTING TECHNIQUES REFERENCE MANUAL, SOLDERRM/D.

STYLE 1:

- PIN 1. BASE
- 2. COLLECTOR
- 3. EMITTER
- 4. COLLECTOR

STYLE 2:

- PIN 1. GATE
- 2. DRAIN
- 3. SOURCE
- 4. DRAIN

STYLE 3:

- PIN 1. ANODE
- 2. CATHODE
- 3. ANODE
- 4. CATHODE

STYLE 4:

- PIN 1. CATHODE
- 2. ANODE
- 3. GATE
- 4. ANODE

STYLE 5:

- PIN 1. GATE
- 2. ANODE
- 3. CATHODE
- 4. ANODE

STYLE 6:

- PIN 1. MT1
- 2. MT2
- 3. GATE
- 4. MT2

STYLE 7:

- PIN 1. GATE
- 2. COLLECTOR
- 3. EMITTER
- 4. COLLECTOR

STYLE 8:

- PIN 1. N/C
- 2. CATHODE
- 3. ANODE
- 4. CATHODE

STYLE 9:

- PIN 1. ANODE
- 2. CATHODE
- 3. RESISTOR ADJUST
- 4. CATHODE

STYLE 10:

- PIN 1. CATHODE
- 2. ANODE
- 3. CATHODE
- 4. ANODE

NOTES:

- DIMENSIONING AND TOLERANCING ASME Y14.5M, 1994.
- CONTROLLING DIMENSION: INCHES
- THERMAL PAD CONTOUR OPTIONAL WITHIN DIMENSIONS b3, L3, AND Z.
- DIMENSIONS D AND E DO NOT INCLUDE MOLD FLASH, PROTRUSIONS, OR BURRS. MOLD FLASH, PROTRUSIONS, OR GATE BURRS SHALL NOT EXCEED 0.006 INCHES PER SIDE.
- DIMENSIONS D AND E ARE DETERMINED AT THE OUTERMOST EXTREMES OF THE PLASTIC BODY.
- DATUMS A AND B ARE DETERMINED AT DATUM PLANE H.
- OPTIONAL MOLD FEATURE.

DIM	INCHES		MILLIMETERS	
	MIN.	MAX.	MIN.	MAX.
A	0.086	0.094	2.18	2.38
A1	0.000	0.005	0.00	0.13
b	0.025	0.035	0.63	0.89
b2	0.028	0.045	0.72	1.14
b3	0.180	0.215	4.57	5.46
c	0.018	0.024	0.46	0.61
c2	0.018	0.024	0.46	0.61
D	0.235	0.245	5.97	6.22
E	0.250	0.265	6.35	6.73
e	0.090	BSC	2.29	BSC
H	0.370	0.410	9.40	10.41
L	0.055	0.070	1.40	1.78
L1	0.114	REF	2.90	REF
L2	0.020	BSC	0.51	BSC
L3	0.035	0.050	0.89	1.27
L4	----	0.040	---	1.01
Z	0.155	----	3.93	---

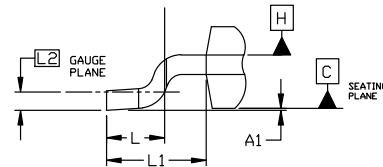

DETAIL A  
ROTATED 90° CW

GENERIC MARKING DIAGRAM\*



IC

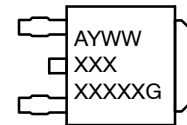

Discrete

- XXXXXX = Device Code
- A = Assembly Location
- L = Wafer Lot
- Y = Year
- WW = Work Week
- G = Pb-Free Package

\*This information is generic. Please refer to device data sheet for actual part marking. Pb-Free indicator, "G" or microdot "•", may or may not be present. Some products may not follow the Generic Marking.

DOCUMENT NUMBER:	98AON10527D	Electronic versions are uncontrolled except when accessed directly from the Document Repository. Printed versions are uncontrolled except when stamped "CONTROLLED COPY" in red.
DESCRIPTION:	DPAK (SINGLE GAUGE)	PAGE 1 OF 1

onsemi and Onsemi are trademarks of Semiconductor Components Industries, LLC dba onsemi or its subsidiaries in the United States and/or other countries. onsemi reserves the right to make changes without further notice to any products herein. onsemi makes no warranty, representation or guarantee regarding the suitability of its products for any particular purpose, nor does onsemi assume any liability arising out of the application or use of any product or circuit, and specifically disclaims any and all liability, including without limitation special, consequential or incidental damages. onsemi does not convey any license under its patent rights nor the rights of others.

**onsemi**, **Onsemi**, and other names, marks, and brands are registered and/or common law trademarks of Semiconductor Components Industries, LLC dba "**onsemi**" or its affiliates and/or subsidiaries in the United States and/or other countries. **onsemi** owns the rights to a number of patents, trademarks, copyrights, trade secrets, and other intellectual property. A listing of **onsemi**'s product/patent coverage may be accessed at [www.onsemi.com/site/pdf/Patent-Marking.pdf](http://www.onsemi.com/site/pdf/Patent-Marking.pdf). **onsemi** reserves the right to make changes at any time to any products or information herein, without notice. The information herein is provided "as-is" and **onsemi** makes no warranty, representation or guarantee regarding the accuracy of the information, product features, availability, functionality, or suitability of its products for any particular purpose, nor does **onsemi** assume any liability arising out of the application or use of any product or circuit, and specifically disclaims any and all liability, including without limitation special, consequential or incidental damages. Buyer is responsible for its products and applications using **onsemi** products, including compliance with all laws, regulations and safety requirements or standards, regardless of any support or applications information provided by **onsemi**. "Typical" parameters which may be provided in **onsemi** data sheets and/or specifications can and do vary in different applications and actual performance may vary over time. All operating parameters, including "Typicals" must be validated for each customer application by customer's technical experts. **onsemi** does not convey any license under any of its intellectual property rights nor the rights of others. **onsemi** products are not designed, intended, or authorized for use as a critical component in life support systems or any FDA Class 3 medical devices or medical devices with a same or similar classification in a foreign jurisdiction or any devices intended for implantation in the human body. Should Buyer purchase or use **onsemi** products for any such unintended or unauthorized application, Buyer shall indemnify and hold **onsemi** and its officers, employees, subsidiaries, affiliates, and distributors harmless against all claims, costs, damages, and expenses, and reasonable attorney fees arising out of, directly or indirectly, any claim of personal injury or death associated with such unintended or unauthorized use, even if such claim alleges that **onsemi** was negligent regarding the design or manufacture of the part. **onsemi** is an Equal Opportunity/Affirmative Action Employer. This literature is subject to all applicable copyright laws and is not for resale in any manner.

## ADDITIONAL INFORMATION

### TECHNICAL PUBLICATIONS:

Technical Library: [www.onsemi.com/design/resources/technical-documentation](http://www.onsemi.com/design/resources/technical-documentation)  
onsemi Website: [www.onsemi.com](http://www.onsemi.com)

### ONLINE SUPPORT: [www.onsemi.com/support](http://www.onsemi.com/support)

For additional information, please contact your local Sales Representative at [www.onsemi.com/support/sales](http://www.onsemi.com/support/sales)