

# High Current Surface Mount PNP Silicon Switching Transistor for Load Management in Portable Applications

## MBT35200MT1

### Features

- AEC-Q101 Qualified and PPAP Capable
- S Prefix for Automotive and Other Applications Requiring Unique Site and Control Change Requirements
- These Devices are Pb-Free, Halogen Free/BFR Free and are RoHS Compliant

### MAXIMUM RATINGS (T<sub>A</sub> = 25°C)

| Rating                         | Symbol           | Max                       | Unit |
|--------------------------------|------------------|---------------------------|------|
| Collector-Emitter Voltage      | V <sub>CEO</sub> | -35                       | Vdc  |
| Collector-Base Voltage         | V <sub>CBO</sub> | -55                       | Vdc  |
| Emitter-Base Voltage           | V <sub>EBO</sub> | -5.0                      | Vdc  |
| Collector Current - Continuous | I <sub>C</sub>   | -2.0                      | Adc  |
| Collector Current - Peak       | I <sub>CM</sub>  | -5.0                      | A    |
| Electrostatic Discharge        | ESD              | HBM Class 3<br>MM Class C |      |

### THERMAL CHARACTERISTICS

| Characteristic                                                         | Symbol                                | Max            | Unit        |
|------------------------------------------------------------------------|---------------------------------------|----------------|-------------|
| Total Device Dissipation<br>T <sub>A</sub> = 25°C<br>Derate above 25°C | P <sub>D</sub> (Note 1)               | 625<br>5.0     | mW<br>mW/°C |
| Thermal Resistance,<br>Junction-to-Ambient                             | R <sub>θJA</sub> (Note 1)             | 200            | °C/W        |
| Total Device Dissipation<br>T <sub>A</sub> = 25°C<br>Derate above 25°C | P <sub>D</sub> (Note 2)               | 1.0<br>8.0     | W<br>mW/°C  |
| Thermal Resistance,<br>Junction-to-Ambient                             | R <sub>θJA</sub> (Note 2)             | 120            | °C/W        |
| Thermal Resistance,<br>Junction-to-Lead #1                             | R <sub>θJL</sub>                      | 80             | °C/W        |
| Total Device Dissipation<br>(Single Pulse < 10 sec.)                   | P <sub>Dsingle</sub><br>(Notes 2 & 3) | 1.75           | W           |
| Junction and Storage<br>Temperature Range                              | T <sub>J</sub> , T <sub>stg</sub>     | -55 to<br>+150 | °C          |

Stresses exceeding those listed in the Maximum Ratings table may damage the device. If any of these limits are exceeded, device functionality should not be assumed, damage may occur and reliability may be affected.

1. FR-4 @ Minimum Pad
2. FR-4 @ 1.0 X 1.0 inch Pad
3. ref: Figure 9

\*For additional information on our Pb-Free strategy and soldering details, please download the **onsemi** Soldering and Mounting Techniques Reference Manual, SOLDERRM/D.

35 VOLTS  
2.0 AMPS  
PNP TRANSISTOR



CASE 318G  
TSOP-6  
STYLE 6

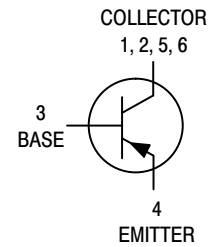

### MARKING DIAGRAM

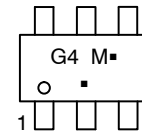

G4 = Specific Device Code  
M = Date Code  
▪ = Pb-Free Package

(Note: Microdot may be in either location)

### ORDERING INFORMATION

| Device       | Package             | Shipping†              |
|--------------|---------------------|------------------------|
| MBT35200MT1G | TSOP-6<br>(Pb-Free) | 3,000 /<br>Tape & Reel |

### DISCONTINUED (Note 1)

|               |                     |                        |
|---------------|---------------------|------------------------|
| SMBT35200MT1G | TSOP-6<br>(Pb-Free) | 3,000 /<br>Tape & Reel |
|---------------|---------------------|------------------------|

†For information on tape and reel specifications, including part orientation and tape sizes, please refer to our Tape and Reel Packaging Specifications Brochure, BRD8011/D.

1. **DISCONTINUED:** This device is not recommended for new design. Please contact your **onsemi** representative for information. The most current information on this device may be available on [www.onsemi.com](http://www.onsemi.com).

# MBT35200MT1

## ELECTRICAL CHARACTERISTICS (T<sub>A</sub> = 25°C unless otherwise noted)

| Characteristic                                                                         | Symbol               | Min  | Typical | Max  | Unit             |
|----------------------------------------------------------------------------------------|----------------------|------|---------|------|------------------|
| <b>OFF CHARACTERISTICS</b>                                                             |                      |      |         |      |                  |
| Collector – Emitter Breakdown Voltage<br>(I <sub>C</sub> = -10 mA, I <sub>B</sub> = 0) | V <sub>(BR)CEO</sub> | -35  | -45     | -    | Vdc              |
| Collector – Base Breakdown Voltage<br>(I <sub>C</sub> = -0.1 mA, I <sub>E</sub> = 0)   | V <sub>(BR)CBO</sub> | -55  | -65     | -    | Vdc              |
| Emitter – Base Breakdown Voltage<br>(I <sub>E</sub> = -0.1 mA, I <sub>C</sub> = 0)     | V <sub>(BR)EBO</sub> | -5.0 | -7.0    | -    | Vdc              |
| Collector Cutoff Current<br>(V <sub>CB</sub> = -35 Vdc, I <sub>E</sub> = 0)            | I <sub>CBO</sub>     | -    | -0.03   | -0.1 | μA <sub>dc</sub> |
| Collector – Emitter Cutoff Current<br>(V <sub>CE</sub> = -35 Vdc)                      | I <sub>CES</sub>     | -    | -0.03   | -0.1 | μA <sub>dc</sub> |
| Emitter Cutoff Current<br>(V <sub>EB</sub> = -4.0 Vdc)                                 | I <sub>EBO</sub>     | -    | -0.01   | -0.1 | μA <sub>dc</sub> |

## ON CHARACTERISTICS

|                                                                                                                                                                                                                        |                      |                   |                            |                         |     |
|------------------------------------------------------------------------------------------------------------------------------------------------------------------------------------------------------------------------|----------------------|-------------------|----------------------------|-------------------------|-----|
| DC Current Gain (Note 1)<br>(I <sub>C</sub> = -1.0 A, V <sub>CE</sub> = -1.5 V)<br>(I <sub>C</sub> = -1.5 A, V <sub>CE</sub> = -1.5 V)<br>(I <sub>C</sub> = -2.0 A, V <sub>CE</sub> = -3.0 V)                          | h <sub>FE</sub>      | 100<br>100<br>100 | 200<br>200<br>200          | -<br>400<br>-           |     |
| Collector – Emitter Saturation Voltage (Note 1)<br>(I <sub>C</sub> = -0.8 A, I <sub>B</sub> = -0.008 A)<br>(I <sub>C</sub> = -1.2 A, I <sub>B</sub> = -0.012 A)<br>(I <sub>C</sub> = -2.0 A, I <sub>B</sub> = -0.02 A) | V <sub>CE(sat)</sub> | -<br>-<br>-       | -0.125<br>-0.175<br>-0.260 | -0.15<br>-0.20<br>-0.31 | V   |
| Base – Emitter Saturation Voltage (Note 1)<br>(I <sub>C</sub> = -1.2 A, I <sub>B</sub> = -0.012 A)                                                                                                                     | V <sub>BE(sat)</sub> | -                 | -0.68                      | -0.85                   | V   |
| Base – Emitter Turn-on Voltage (Note 1)<br>(I <sub>C</sub> = -2.0 A, V <sub>CE</sub> = -3.0 V)                                                                                                                         | V <sub>BE(on)</sub>  | -                 | -0.81                      | -0.875                  | V   |
| Cutoff Frequency<br>(I <sub>C</sub> = -100 mA, V <sub>CE</sub> = -5.0 V, f = 100 MHz)                                                                                                                                  | f <sub>T</sub>       | 100               | -                          | -                       | MHz |
| Input Capacitance (V <sub>EB</sub> = -0.5 V, f = 1.0 MHz)                                                                                                                                                              | C <sub>ibo</sub>     | -                 | 600                        | 650                     | pF  |
| Output Capacitance (V <sub>CB</sub> = -3.0 V, f = 1.0 MHz)                                                                                                                                                             | C <sub>obo</sub>     | -                 | 85                         | 100                     | pF  |
| Turn-on Time (V <sub>CC</sub> = -10 V, I <sub>B1</sub> = -100 mA, I <sub>C</sub> = -1 A, R <sub>L</sub> = 3 Ω)                                                                                                         | t <sub>on</sub>      | -                 | 35                         | -                       | nS  |
| Turn-off Time (V <sub>CC</sub> = -10 V, I <sub>B1</sub> = I <sub>B2</sub> = -100 mA, I <sub>C</sub> = 1 A, R <sub>L</sub> = 3 Ω)                                                                                       | t <sub>off</sub>     | -                 | 225                        | -                       | nS  |

Product parametric performance is indicated in the Electrical Characteristics for the listed test conditions, unless otherwise noted. Product performance may not be indicated by the Electrical Characteristics if operated under different conditions.

1. Pulsed Condition: Pulse Width = 300 μsec, Duty Cycle ≤ 2%

# MBT35200MT1

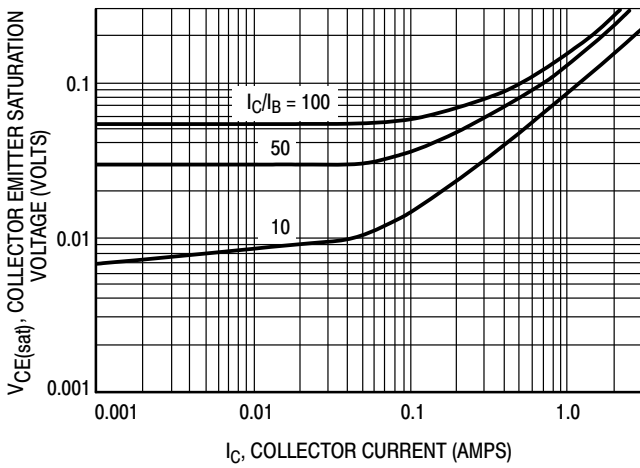

**Figure 1. Collector Emitter Saturation Voltage versus Collector Current**

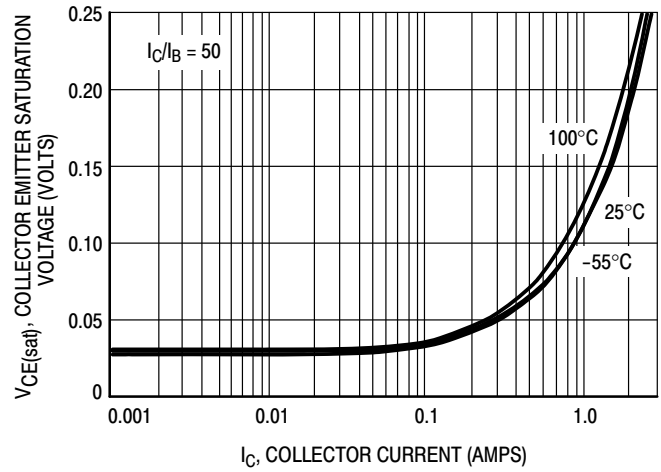

**Figure 2. Collector Emitter Saturation Voltage versus Collector Current**

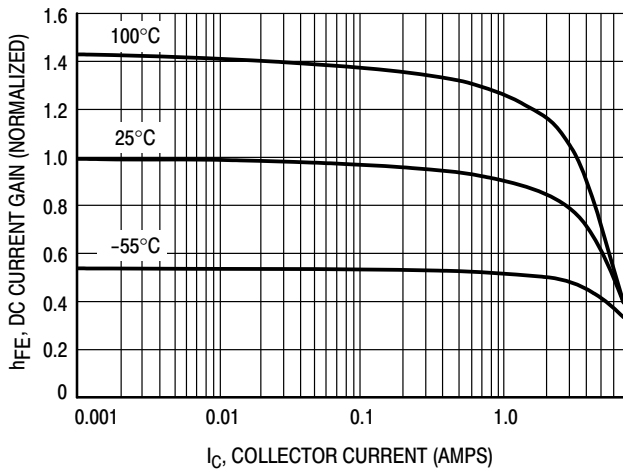

**Figure 3. DC Current Gain versus Collector Current**

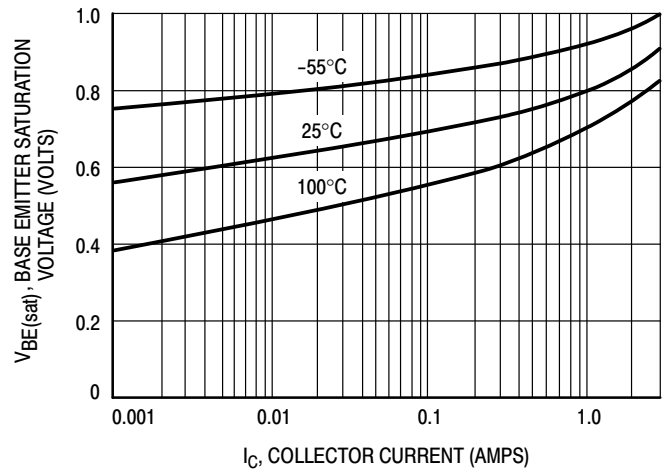

**Figure 4. Base Emitter Saturation Voltage versus Collector Current**

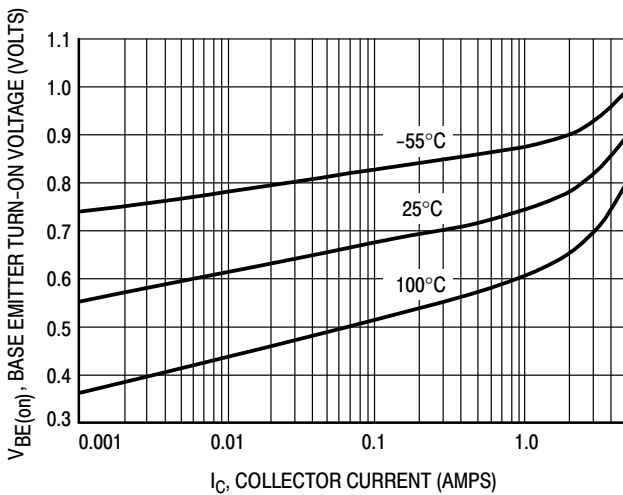

**Figure 5. Base Emitter Turn-On Voltage versus Collector Current**

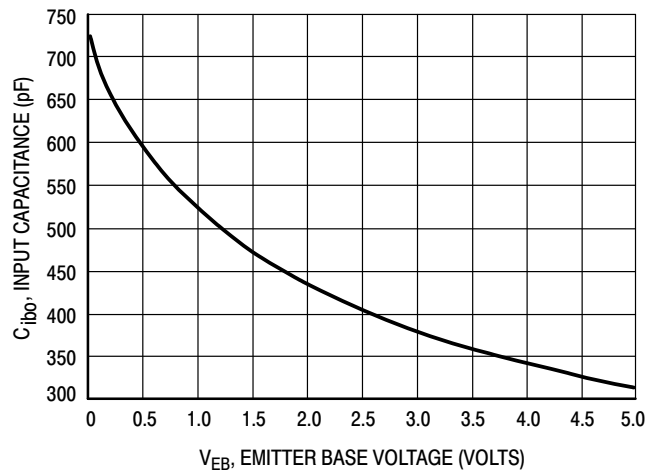

**Figure 6. Input Capacitance**

# MBT35200MT1

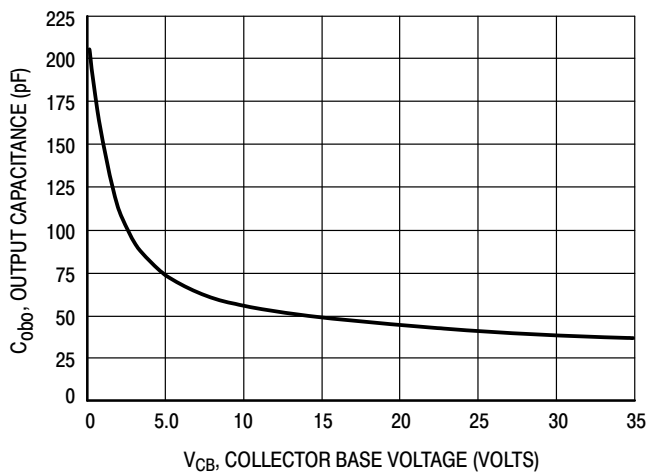

Figure 7. Output Capacitance

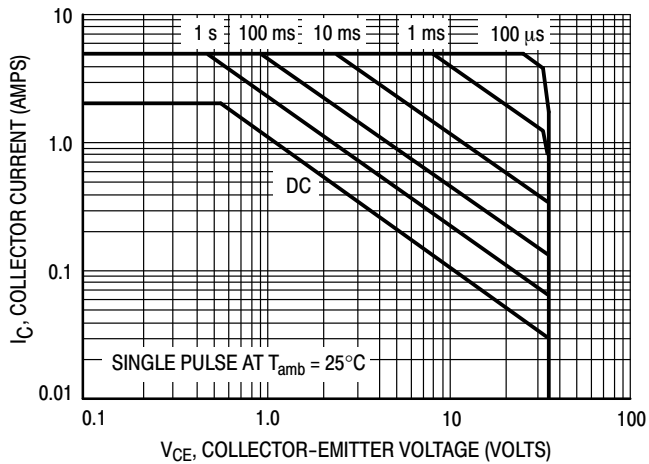

Figure 8. Safe Operating Area

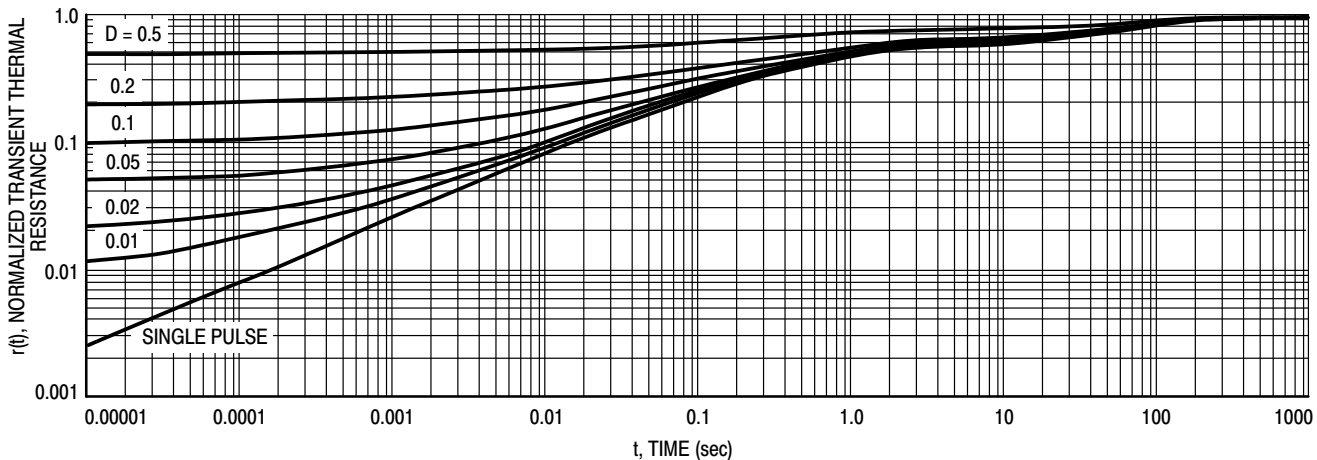
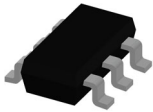
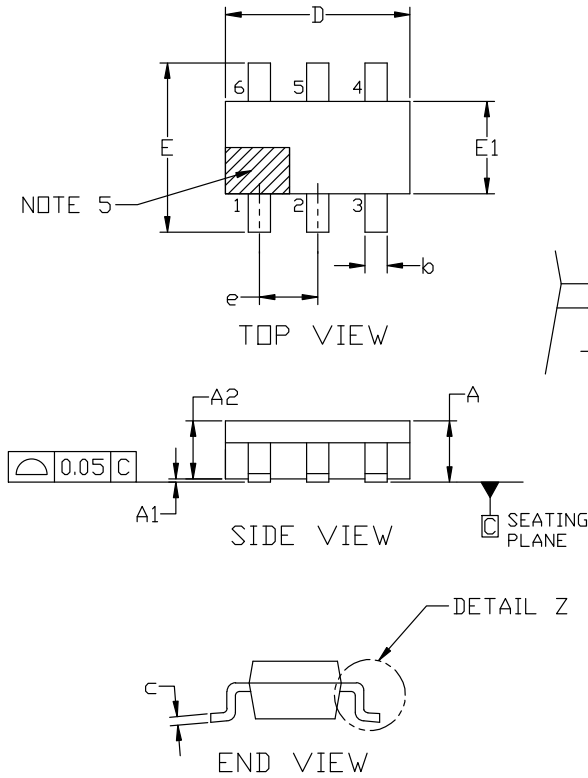

Figure 9. Normalized Thermal Response



**TSOP-6 3.00x1.50x0.90, 0.95P**  
**CASE 318G**  
**ISSUE W**

DATE 26 FEB 2024



NOTES:

1. DIMENSIONING AND TOLERANCING PER ASME Y14.5M, 2018.
2. CONTROLLING DIMENSION: MILLIMETERS.
3. MAXIMUM LEAD THICKNESS INCLUDES LEAD FINISH. MINIMUM LEAD THICKNESS IS THE MINIMUM THICKNESS OF BASE MATERIAL.
4. DIMENSIONS D AND E1 DO NOT INCLUDE MOLD FLASH, PROTRUSIONS, OR GATE BURRS. MOLD FLASH, PROTRUSIONS, OR GATE BURRS SHALL NOT EXCEED 0.15 PER SIDE. DIMENSIONS D AND E1 ARE DETERMINED AT DATUM H.
5. PIN 1 INDICATOR MUST BE LOCATED IN THE INDICATED ZONE

| MILLIMETERS |          |      |      |
|-------------|----------|------|------|
| DIM         | MIN      | NOM  | MAX  |
| A           | 0.90     | 1.00 | 1.10 |
| A1          | 0.01     | 0.06 | 0.10 |
| A2          | 0.80     | 0.90 | 1.00 |
| b           | 0.25     | 0.38 | 0.50 |
| c           | 0.10     | 0.18 | 0.26 |
| D           | 2.90     | 3.00 | 3.10 |
| E           | 2.50     | 2.75 | 3.00 |
| E1          | 1.30     | 1.50 | 1.70 |
| e           | 0.85     | 0.95 | 1.05 |
| L           | 0.20     | 0.40 | 0.60 |
| L2          | 0.25 BSC |      |      |
| M           | 0°       | ---  | 10°  |

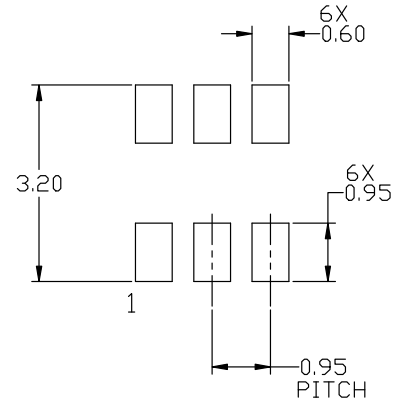

RECOMMENDED MOUNTING FOOTPRINT

\*For additional information on our Pb-Free strategy and soldering details, please download the ON Semiconductor Soldering and Mounting Techniques Reference manual, SOLDERRM/D.

|                         |                                     |                                                                                                                                                                                  |
|-------------------------|-------------------------------------|----------------------------------------------------------------------------------------------------------------------------------------------------------------------------------|
| <b>DOCUMENT NUMBER:</b> | <b>98ASB14888C</b>                  | Electronic versions are uncontrolled except when accessed directly from the Document Repository. Printed versions are uncontrolled except when stamped "CONTROLLED COPY" in red. |
| <b>DESCRIPTION:</b>     | <b>TSOP-6 3.00x1.50x0.90, 0.95P</b> | <b>PAGE 1 OF 2</b>                                                                                                                                                               |

onsemi and ONSEMI are trademarks of Semiconductor Components Industries, LLC dba onsemi or its subsidiaries in the United States and/or other countries. onsemi reserves the right to make changes without further notice to any products herein. onsemi makes no warranty, representation or guarantee regarding the suitability of its products for any particular purpose, nor does onsemi assume any liability arising out of the application or use of any product or circuit, and specifically disclaims any and all liability, including without limitation special, consequential or incidental damages. onsemi does not convey any license under its patent rights nor the rights of others.

**TSOP-6 3.00x1.50x0.90, 0.95P**  
**CASE 318G**  
**ISSUE W**

DATE 26 FEB 2024

**GENERIC  
MARKING DIAGRAM\***

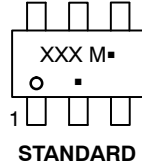
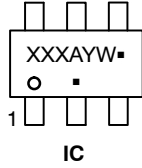

|                            |                            |
|----------------------------|----------------------------|
| XXX = Specific Device Code | XXX = Specific Device Code |
| A = Assembly Location      | M = Date Code              |
| Y = Year                   | ■ = Pb-Free Package        |
| W = Work Week              |                            |
| ■ = Pb-Free Package        |                            |

\*This information is generic. Please refer to device data sheet for actual part marking. Pb-Free indicator, "G" or microdot "■", may or may not be present. Some products may not follow the Generic Marking.

- |                                                                                                          |                                                                                                                      |                                                                                                                     |                                                                                                             |                                                                                                                   |                                                                                                              |
|----------------------------------------------------------------------------------------------------------|----------------------------------------------------------------------------------------------------------------------|---------------------------------------------------------------------------------------------------------------------|-------------------------------------------------------------------------------------------------------------|-------------------------------------------------------------------------------------------------------------------|--------------------------------------------------------------------------------------------------------------|
| <b>STYLE 1:</b><br>PIN 1. DRAIN<br>2. DRAIN<br>3. GATE<br>4. SOURCE<br>5. DRAIN<br>6. DRAIN              | <b>STYLE 2:</b><br>PIN 1. EMITTER 2<br>2. BASE 1<br>3. COLLECTOR 1<br>4. EMITTER 1<br>5. BASE 2<br>6. COLLECTOR 2    | <b>STYLE 3:</b><br>PIN 1. ENABLE<br>2. N/C<br>3. R BOOST<br>4. Vz<br>5. V in<br>6. V out                            | <b>STYLE 4:</b><br>PIN 1. N/C<br>2. V in<br>3. NOT USED<br>4. GROUND<br>5. ENABLE<br>6. LOAD                | <b>STYLE 5:</b><br>PIN 1. EMITTER 2<br>2. BASE 2<br>3. COLLECTOR 1<br>4. EMITTER 1<br>5. BASE 1<br>6. COLLECTOR 2 | <b>STYLE 6:</b><br>PIN 1. COLLECTOR<br>2. COLLECTOR<br>3. BASE<br>4. EMITTER<br>5. COLLECTOR<br>6. COLLECTOR |
| <b>STYLE 7:</b><br>PIN 1. COLLECTOR<br>2. COLLECTOR<br>3. BASE<br>4. N/C<br>5. COLLECTOR<br>6. EMITTER   | <b>STYLE 8:</b><br>PIN 1. Vbus<br>2. D(in)<br>3. D(in)+<br>4. D(out)+<br>5. D(out)<br>6. GND                         | <b>STYLE 9:</b><br>PIN 1. LOW VOLTAGE GATE<br>2. DRAIN<br>3. SOURCE<br>4. DRAIN<br>5. DRAIN<br>6. HIGH VOLTAGE GATE | <b>STYLE 10:</b><br>PIN 1. D(OUT)+<br>2. GND<br>3. D(OUT)-<br>4. D(IN)-<br>5. VBUS<br>6. D(IN)+             | <b>STYLE 11:</b><br>PIN 1. SOURCE 1<br>2. DRAIN 2<br>3. DRAIN 2<br>4. SOURCE 2<br>5. GATE 1<br>6. DRAIN 1/GATE 2  | <b>STYLE 12:</b><br>PIN 1. I/O<br>2. GROUND<br>3. I/O<br>4. I/O<br>5. VCC<br>6. I/O                          |
| <b>STYLE 13:</b><br>PIN 1. GATE 1<br>2. SOURCE 2<br>3. GATE 2<br>4. DRAIN 2<br>5. SOURCE 1<br>6. DRAIN 1 | <b>STYLE 14:</b><br>PIN 1. ANODE<br>2. SOURCE<br>3. GATE<br>4. CATHODE/DRAIN<br>5. CATHODE/DRAIN<br>6. CATHODE/DRAIN | <b>STYLE 15:</b><br>PIN 1. ANODE<br>2. SOURCE<br>3. GATE<br>4. DRAIN<br>5. N/C<br>6. CATHODE                        | <b>STYLE 16:</b><br>PIN 1. ANODE/CATHODE<br>2. BASE<br>3. EMITTER<br>4. COLLECTOR<br>5. ANODE<br>6. CATHODE | <b>STYLE 17:</b><br>PIN 1. EMITTER<br>2. BASE<br>3. ANODE/CATHODE<br>4. ANODE<br>5. CATHODE<br>6. COLLECTOR       |                                                                                                              |

|                         |                                     |                                                                                                                                                                                     |
|-------------------------|-------------------------------------|-------------------------------------------------------------------------------------------------------------------------------------------------------------------------------------|
| <b>DOCUMENT NUMBER:</b> | <b>98ASB14888C</b>                  | Electronic versions are uncontrolled except when accessed directly from the Document Repository.<br>Printed versions are uncontrolled except when stamped "CONTROLLED COPY" in red. |
| <b>DESCRIPTION:</b>     | <b>TSOP-6 3.00x1.50x0.90, 0.95P</b> | <b>PAGE 2 OF 2</b>                                                                                                                                                                  |

**onsemi** and **ONSEMI** are trademarks of Semiconductor Components Industries, LLC dba **onsemi** or its subsidiaries in the United States and/or other countries. **onsemi** reserves the right to make changes without further notice to any products herein. **onsemi** makes no warranty, representation or guarantee regarding the suitability of its products for any particular purpose, nor does **onsemi** assume any liability arising out of the application or use of any product or circuit, and specifically disclaims any and all liability, including without limitation special, consequential or incidental damages. **onsemi** does not convey any license under its patent rights nor the rights of others.

**onsemi**, **Onsemi**, and other names, marks, and brands are registered and/or common law trademarks of Semiconductor Components Industries, LLC dba "**onsemi**" or its affiliates and/or subsidiaries in the United States and/or other countries. **onsemi** owns the rights to a number of patents, trademarks, copyrights, trade secrets, and other intellectual property. A listing of **onsemi**'s product/patent coverage may be accessed at [www.onsemi.com/site/pdf/Patent-Marking.pdf](http://www.onsemi.com/site/pdf/Patent-Marking.pdf). **onsemi** reserves the right to make changes at any time to any products or information herein, without notice. The information herein is provided "as-is" and **onsemi** makes no warranty, representation or guarantee regarding the accuracy of the information, product features, availability, functionality, or suitability of its products for any particular purpose, nor does **onsemi** assume any liability arising out of the application or use of any product or circuit, and specifically disclaims any and all liability, including without limitation special, consequential or incidental damages. Buyer is responsible for its products and applications using **onsemi** products, including compliance with all laws, regulations and safety requirements or standards, regardless of any support or applications information provided by **onsemi**. "Typical" parameters which may be provided in **onsemi** data sheets and/or specifications can and do vary in different applications and actual performance may vary over time. All operating parameters, including "Typicals" must be validated for each customer application by customer's technical experts. **onsemi** does not convey any license under any of its intellectual property rights nor the rights of others. **onsemi** products are not designed, intended, or authorized for use as a critical component in life support systems or any FDA Class 3 medical devices or medical devices with a same or similar classification in a foreign jurisdiction or any devices intended for implantation in the human body. Should Buyer purchase or use **onsemi** products for any such unintended or unauthorized application, Buyer shall indemnify and hold **onsemi** and its officers, employees, subsidiaries, affiliates, and distributors harmless against all claims, costs, damages, and expenses, and reasonable attorney fees arising out of, directly or indirectly, any claim of personal injury or death associated with such unintended or unauthorized use, even if such claim alleges that **onsemi** was negligent regarding the design or manufacture of the part. **onsemi** is an Equal Opportunity/Affirmative Action Employer. This literature is subject to all applicable copyright laws and is not for resale in any manner.

## ADDITIONAL INFORMATION

### TECHNICAL PUBLICATIONS:

Technical Library: [www.onsemi.com/design/resources/technical-documentation](http://www.onsemi.com/design/resources/technical-documentation)  
onsemi Website: [www.onsemi.com](http://www.onsemi.com)

### ONLINE SUPPORT: [www.onsemi.com/support](http://www.onsemi.com/support)

For additional information, please contact your local Sales Representative at [www.onsemi.com/support/sales](http://www.onsemi.com/support/sales)