

Complementary Darlington Silicon Power Transistors

MJH11017, MJH11019, MJH11021 (PNP) MJH11018, MJH11020, MJH11022 (NPN)

These devices are designed for use as general purpose amplifiers, low frequency switching and motor control applications.

Features

- High DC Current Gain @ 10 Adc – $h_{FE} = 400$ Min (All Types)
- Collector–Emitter Sustaining Voltage
 $V_{CE(sus)} = 150$ Vdc (Min) – MJH11018, 17
 $= 200$ Vdc (Min) – MJH11020, 19
 $= 250$ Vdc (Min) – MJH11022, 21
- Low Collector–Emitter Saturation Voltage
 $V_{CE(sat)} = 1.2$ V (Typ) @ $I_C = 5.0$ A
 $= 1.8$ V (Typ) @ $I_C = 10$ A
- Monolithic Construction
- These are Pb–Free Devices

MAXIMUM RATINGS

Rating	Symbol	Max	Unit
Collector–Emitter Voltage MJH11018, MJH11017 MJH11020, MJH11019 MJH11022, MJH11021	V_{CEO}	150 200 250	Vdc
Collector–Base Voltage MJH11018, MJH11017 MJH11020, MJH11019 MJH11022, MJH11021	V_{CB}	150 200 250	Vdc
Emitter–Base Voltage	V_{EB}	5.0	Vdc
Collector Current – Continuous – Peak (Note 1)	I_C	15 30	Adc
Base Current	I_B	0.5	Adc
Total Device Dissipation @ $T_C = 25^\circ\text{C}$ Derate above 25°C	P_D	150 1.2	W W/°C
Operating and Storage Junction Temperature Range	T_J, T_{stg}	–65 to +150	°C

THERMAL CHARACTERISTICS

Characteristic	Symbol	Max	Unit
Thermal Resistance, Junction–to–Case	$R_{\theta JC}$	0.83	°C/W

Stresses exceeding those listed in the Maximum Ratings table may damage the device. If any of these limits are exceeded, device functionality should not be assumed, damage may occur and reliability may be affected.

1. Pulse Test: Pulse Width = 5.0 ms, Duty Cycle $\leq 10\%$.

15 AMPERE DARLINGTON COMPLEMENTARY SILICON POWER TRANSISTORS 150–250 VOLTS, 150 WATTS

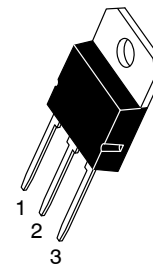
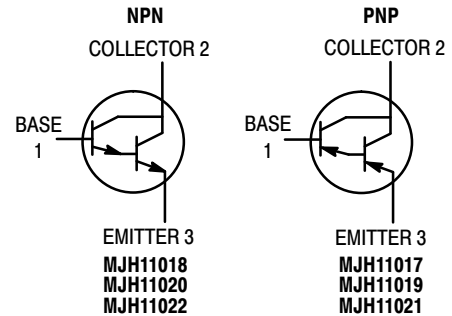

SOT-93
(TO-218)
CASE 340L
STYLE 1

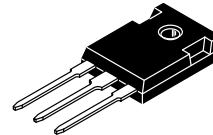

TO-247
CASE 340L
STYLE 3

NOTE: Effective June 2012 this device will be available only in the TO-247 package. Reference FPCN# 16827.

ORDERING INFORMATION

See detailed ordering and shipping information in on page 2 of this data sheet.

MJH11017, MJH11019, MJH11021 (PNP) MJH11018, MJH11020, MJH11022 (NPN)

MARKING DIAGRAMS

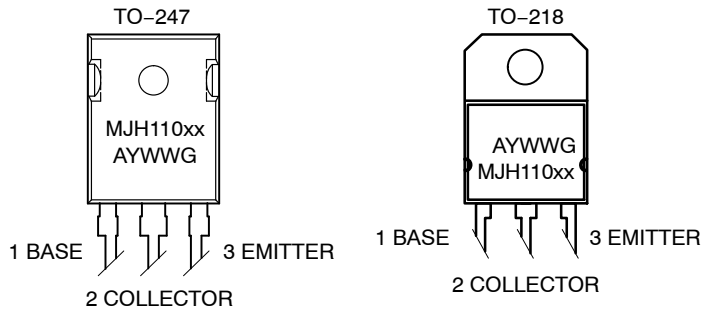

A = Assembly Location
 Y = Year
 WW = Work Week
 G = Pb-Free Package
 MJH110xx = Device Code
 xx = 17, 19, 21, 18, 20, 22

ORDERING INFORMATION

Device Order Number	Package Type	Shipping
MJH11017G	TO-218 (Pb-Free)	30 Units / Rail
MJH11018G	TO-218 (Pb-Free)	30 Units / Rail
MJH11019G	TO-218 (Pb-Free)	30 Units / Rail
MJH11020G	TO-218 (Pb-Free)	30 Units / Rail
MJH11021G	TO-218 (Pb-Free)	30 Units / Rail
MJH11022G	TO-218 (Pb-Free)	30 Units / Rail
MJH11017G	TO-247 (Pb-Free)	30 Units / Rail
MJH11018G	TO-247 (Pb-Free)	30 Units / Rail
MJH11019G	TO-247 (Pb-Free)	30 Units / Rail
MJH11020G	TO-247 (Pb-Free)	30 Units / Rail
MJH11021G	TO-247 (Pb-Free)	30 Units / Rail
MJH11022G	TO-247 (Pb-Free)	30 Units / Rail

MJH11017, MJH11019, MJH11021 (PNP) MJH11018, MJH11020, MJH11022 (NPN)

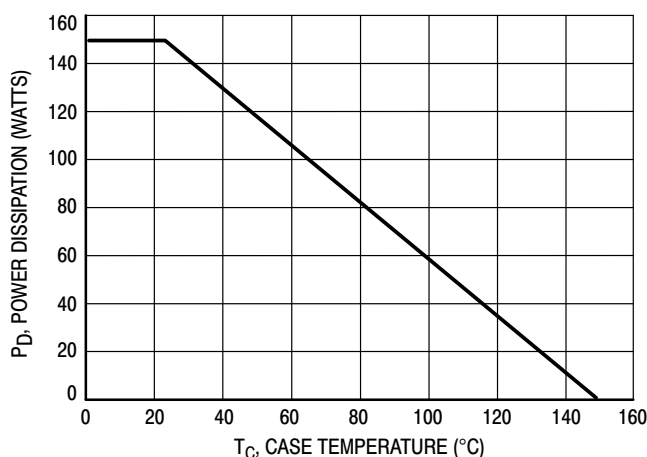

Figure 1. Power Derating

ELECTRICAL CHARACTERISTICS (T_C = 25°C unless otherwise noted)

Characteristic	Symbol	Min	Max	Unit	
OFF CHARACTERISTICS					
Collector–Emitter Sustaining Voltage (Note 2) (I _C = 0.1 Adc, I _B = 0)	MJH11017, MJH11018 MJH11019, MJH11020 MJH11021, MJH11022	V _{CE(sus)}	150 200 250	– – –	Vdc
Collector Cutoff Current (V _{CE} = 75 Vdc, I _B = 0) (V _{CE} = 100 Vdc, I _B = 0) (V _{CE} = 125 Vdc, I _B = 0)	MJH11017, MJH11018 MJH11019, MJH11020 MJH11021, MJH11022	I _{CEO}	– – –	1.0 1.0 1.0	mAdc
Collector Cutoff Current (V _{CE} = Rated V _{CB} , V _{BE(off)} = 1.5 Vdc) (V _{CE} = Rated V _{CB} , V _{BE(off)} = 1.5 Vdc, T _J = 150°C)		I _{CEV}	– –	0.5 5.0	mAdc
Emitter Cutoff Current (V _{BE} = 5.0 Vdc I _C = 0)		I _{EBO}	–	2.0	mAdc

ON CHARACTERISTICS (Note 2)

DC Current Gain (I _C = 10 Adc, V _{CE} = 5.0 Vdc) (I _C = 15 Adc, V _{CE} = 5.0 Vdc)	h _{FE}	400 100	15,000 –	–
Collector–Emitter Saturation Voltage (I _C = 10 Adc, I _B = 100 mA) (I _C = 15 Adc, I _B = 150 mA)	V _{CE(sat)}	– –	2.5 4.0	Vdc
Base–Emitter On Voltage (I _C = 10 A, V _{CE} = 5.0 Vdc)	V _{BE(on)}	–	2.8	Vdc
Base–Emitter Saturation Voltage (I _C = 15 Adc, I _B = 150 mA)	V _{BE(sat)}	–	3.8	Vdc

DYNAMIC CHARACTERISTICS

Current–Gain Bandwidth Product (I _C = 10 Adc, V _{CE} = 3.0 Vdc, f = 1.0 MHz)	f _T	3.0	–	–
Output Capacitance MJH11018, MJH11020, MJH11022 (V _{CB} = 10 Vdc, I _E = 0, f = 0.1 MHz) MJH11017, MJH11019, MJH11021	C _{ob}	– –	400 600	pF
Small–Signal Current Gain (I _C = 10 Adc, V _{CE} = 3.0 Vdc, f = 1.0 kHz)	h _{fe}	75	–	–

SWITCHING CHARACTERISTICS

Characteristic	Symbol	Typical		Unit
		NPN	PNP	
Delay Time	t _d	150	75	ns
Rise Time	t _r	1.2	0.5	μs
Storage Time	t _s	4.4	2.7	μs
Fall Time	t _f	2.5	2.5	μs

(V_{CC} = 100 V, I_C = 10 A, I_B = 100 mA
V_{BE(off)} = 5.0 V) (See Figure 2)

Product parametric performance is indicated in the Electrical Characteristics for the listed test conditions, unless otherwise noted. Product performance may not be indicated by the Electrical Characteristics if operated under different conditions.

2. Pulse Test: Pulse Width = 300 μs, Duty Cycle ≤ 2.0%.

MJH11017, MJH11019, MJH11021 (PNP) MJH11018, MJH11020, MJH11022 (NPN)

R_B & R_C varied to obtain desired current levels
 D_1 , must be fast recovery types, e.g.:
 1N5825 used above $I_B \approx 100$ mA
 MSD6100 used below $I_B \approx 100$ mA

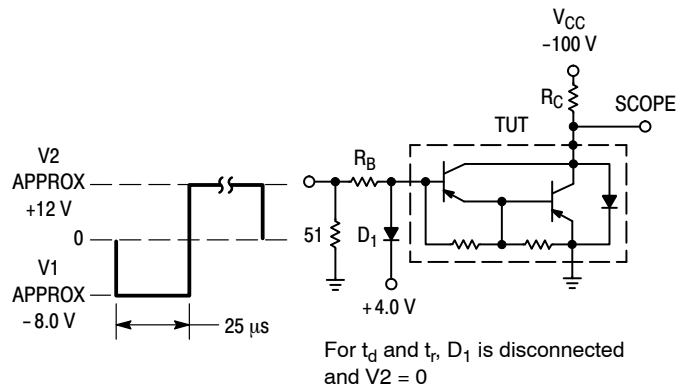

$t_r, t_f \leq 10$ ns
 Duty Cycle = 1.0% For NPN test circuit, reverse diode and voltage polarities.

Figure 2. Switching Times Test Circuit

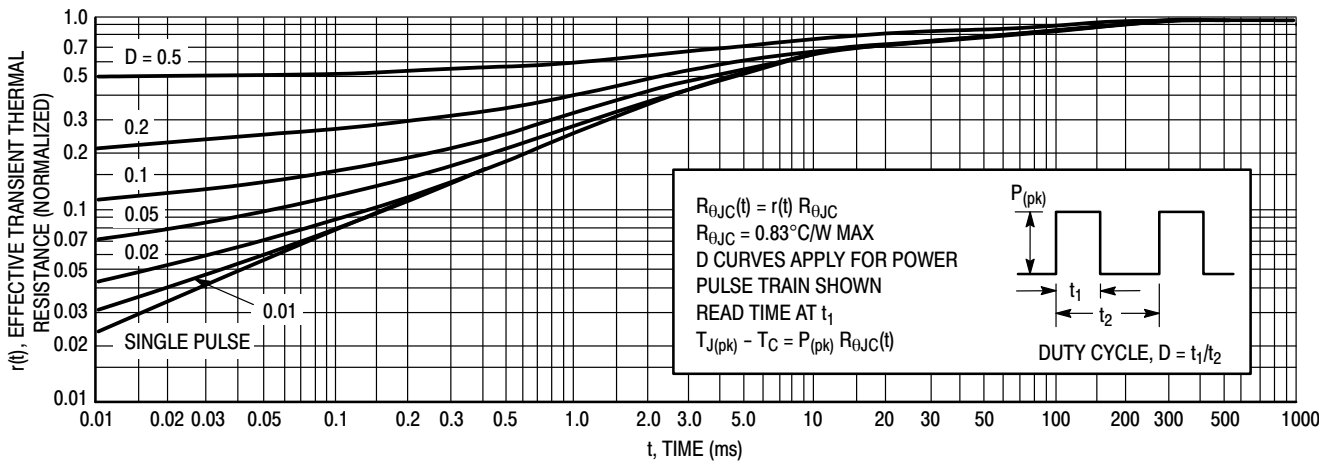

Figure 3. Thermal Response

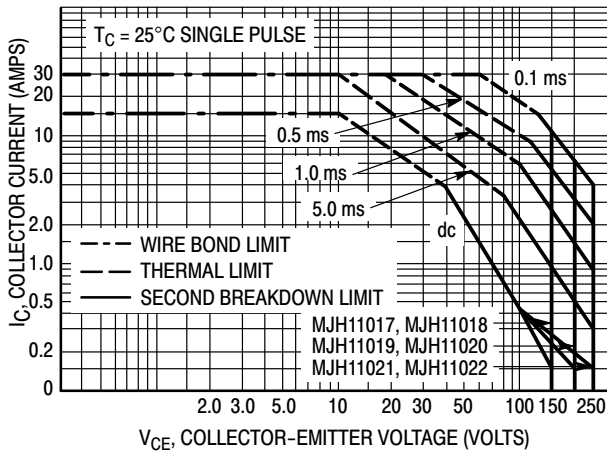

Figure 4. Maximum Rated Forward Bias Safe Operating Area (FBSOA)

FORWARD BIAS

There are two limitations on the power handling ability of a transistor: average junction temperature and second breakdown. Safe operating area curves indicate $I_C - V_{CE}$ limits of the transistor that must be observed for reliable operation; i.e., the transistor must not be subjected to greater dissipation than the curves indicate.

The data of Figure 4 is based on $T_{J(pk)} = 150^\circ\text{C}$; T_C is variable depending on conditions. Second breakdown pulse limits are valid for duty cycles to 10% provided $T_{J(pk)} \leq 150^\circ\text{C}$. $T_{J(pk)}$ may be calculated from the data in Figure 3. At high case temperatures, thermal limitations will reduce the power that can be handled to values less than the limitations imposed by second breakdown.

MJH11017, MJH11019, MJH11021 (PNP) MJH11018, MJH11020, MJH11022 (NPN)

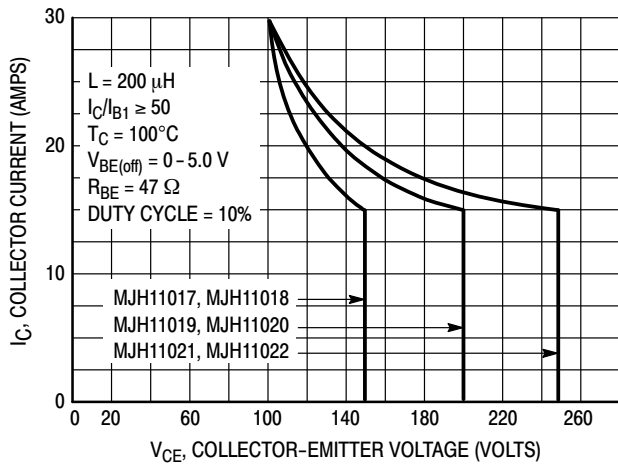

Figure 5. Maximum Rated Reverse Bias Safe Operating Area (RBSOA)

REVERSE BIAS

For inductive loads, high voltage and high current must be sustained simultaneously during turn-off, in most cases, with the base to emitter junction reverse biased. Under these conditions the collector voltage must be held to a safe level at or below a specific value of collector current. This can be accomplished by several means such as active clamping, RC snubbing, load line shaping, etc. The safe level for these devices is specified as Reverse Bias Safe Operating Area and represents the voltage-current conditions during reverse biased turn-off. This rating is verified under clamped conditions so that the device is never subjected to an avalanche mode. Figure 5 gives RBSOA characteristics.

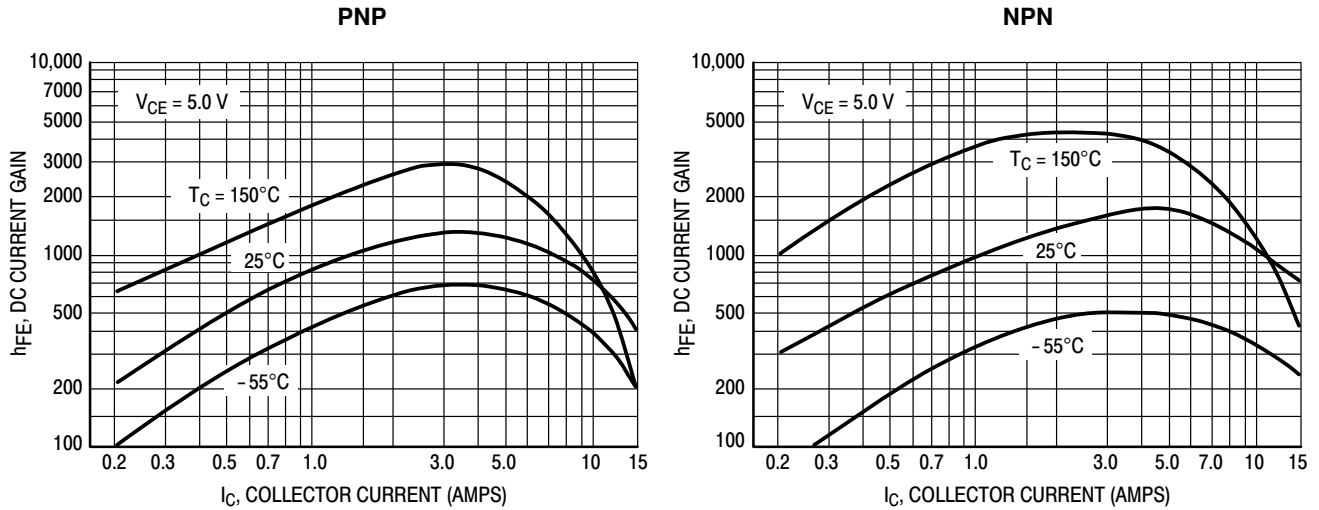

Figure 6. DC Current Gain

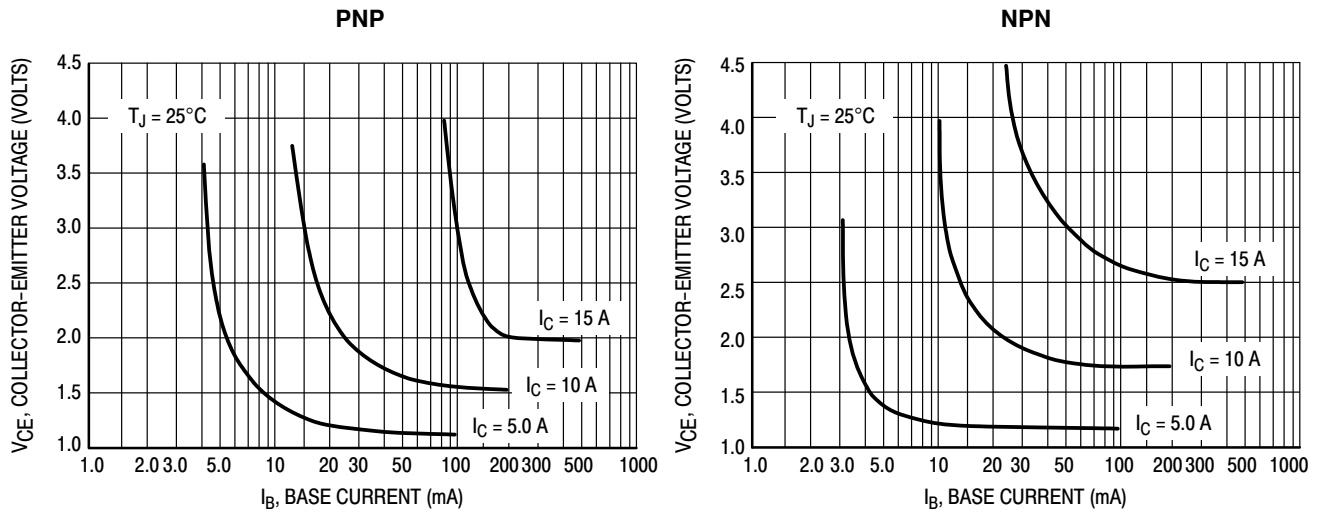

Figure 7. Collector Saturation Region

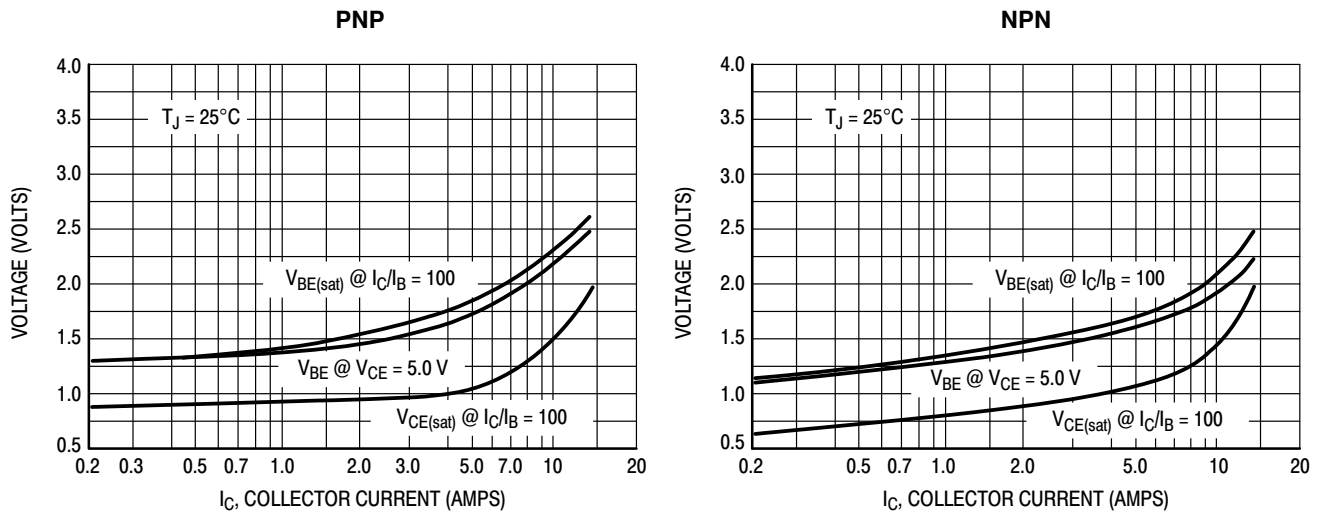

Figure 8. "On" Voltages

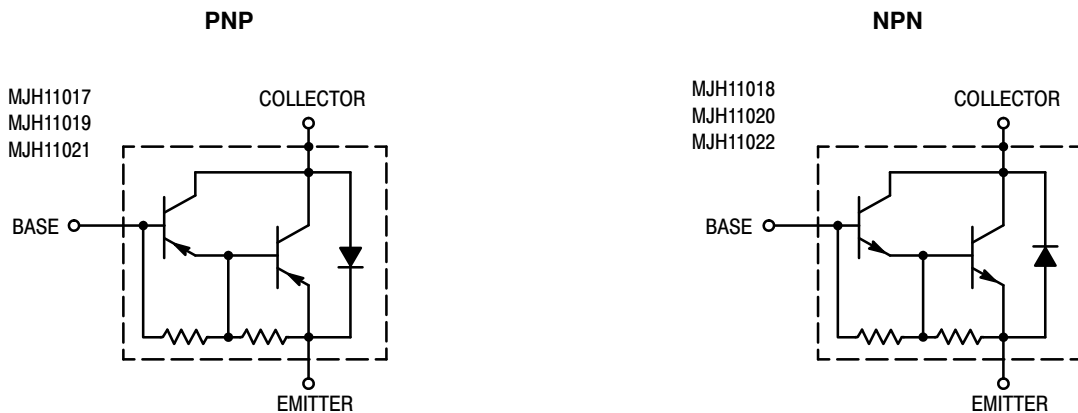
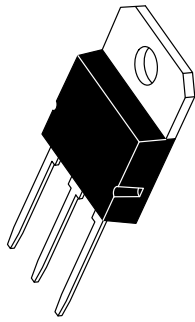

Figure 9. Darlington Schematic

SOT-93 (TO-218)
CASE 340D-02
ISSUE E

DATE 03 JAN 2002



SCALE 1:1

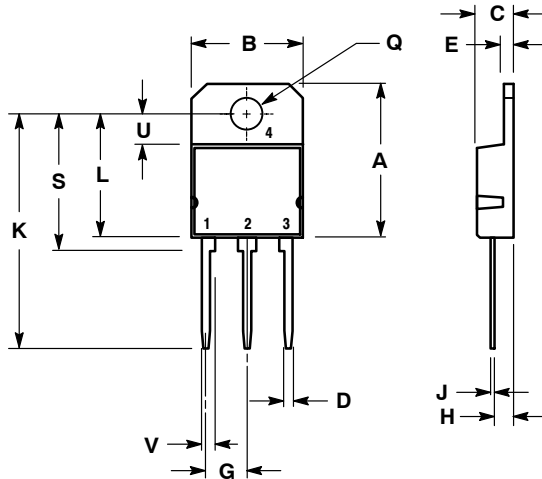

STYLE 1:
PIN 1. BASE
2. COLLECTOR
3. EMITTER
4. COLLECTOR

STYLE 2:
PIN 1. ANODE
2. CATHODE
3. ANODE
4. CATHODE

NOTES:
1. DIMENSIONING AND TOLERANCING PER ANSI Y14.5M, 1982.
2. CONTROLLING DIMENSION: MILLIMETER.

DIM	MILLIMETERS		INCHES	
	MIN	MAX	MIN	MAX
A	---	20.35	---	0.801
B	14.70	15.20	0.579	0.598
C	4.70	4.90	0.185	0.193
D	1.10	1.30	0.043	0.051
E	1.17	1.37	0.046	0.054
G	5.40	5.55	0.213	0.219
H	2.00	3.00	0.079	0.118
J	0.50	0.78	0.020	0.031
K	31.00 REF		1.220 REF	
L	---	16.20	---	0.638
Q	4.00	4.10	0.158	0.161
S	17.80	18.20	0.701	0.717
U	4.00 REF		0.157 REF	
V	1.75 REF		0.069	

GENERIC
MARKING DIAGRAM*



A = Assembly Location
Y = Year
WW = Work Week
XXXXX = Device Code

*This information is generic. Please refer to device data sheet for actual part marking. Pb-Free indicator, "G" or microdot "▪", may or may not be present. Some products may not follow the Generic Marking.

DOCUMENT NUMBER:	98ASB42643B	Electronic versions are uncontrolled except when accessed directly from the Document Repository. Printed versions are uncontrolled except when stamped "CONTROLLED COPY" in red.
DESCRIPTION:	SOT-93 (TO-218)	PAGE 1 OF 1

onsemi and ONSEMI are trademarks of Semiconductor Components Industries, LLC dba onsemi or its subsidiaries in the United States and/or other countries. onsemi reserves the right to make changes without further notice to any products herein. onsemi makes no warranty, representation or guarantee regarding the suitability of its products for any particular purpose, nor does onsemi assume any liability arising out of the application or use of any product or circuit, and specifically disclaims any and all liability, including without limitation special, consequential or incidental damages. onsemi does not convey any license under its patent rights nor the rights of others.

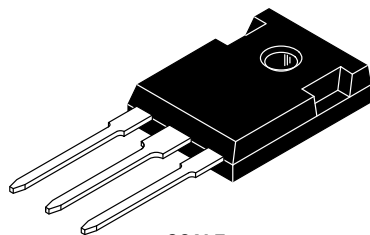

TO-247
CASE 340L
ISSUE G

DATE 06 OCT 2021

SCALE 1:1

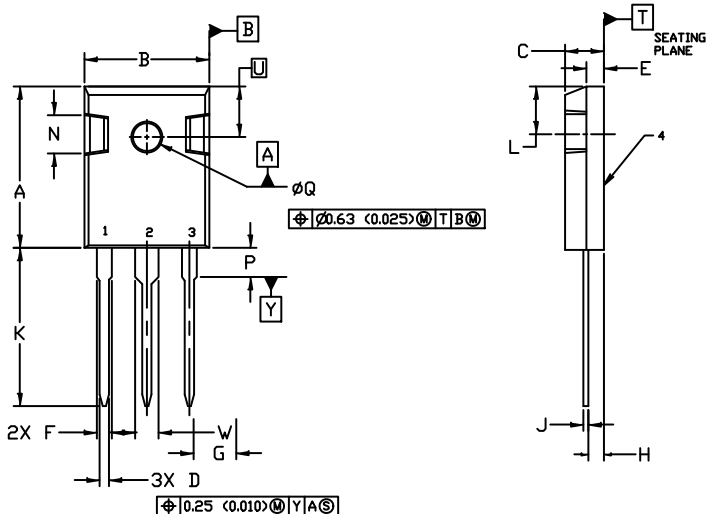

NOTES:

1. DIMENSIONING AND TOLERANCING PER ASME Y14.5M, 1982.
2. CONTROLLING DIMENSION: MILLIMETER

DIM	MILLIMETERS		INCHES	
	MIN.	MAX.	MIN.	MAX.
A	20.32	21.08	0.800	0.830
B	15.75	16.26	0.620	0.640
C	4.70	5.30	0.185	0.209
D	1.00	1.40	0.040	0.055
E	1.90	2.60	0.075	0.102
F	1.65	2.13	0.065	0.084
G	5.45 BSC		0.215 BSC	
H	1.50	2.49	0.059	0.098
J	0.40	0.80	0.016	0.031
K	19.81	20.83	0.780	0.820
L	5.40	6.20	0.212	0.244
N	4.32	5.49	0.170	0.216
P	----	4.50	----	0.177
Q	3.55	3.65	0.140	0.144
U	6.15 BSC		0.242 BSC	
W	2.87	3.12	0.113	0.123

GENERIC
MARKING DIAGRAM*

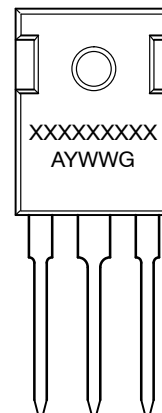

- | | | | |
|--|--|--|--|
| <p>STYLE 1:
PIN 1. GATE
2. DRAIN
3. SOURCE
4. DRAIN</p> | <p>STYLE 2:
PIN 1. ANODE
2. CATHODE (S)
3. ANODE 2
4. CATHODES (S)</p> | <p>STYLE 3:
PIN 1. BASE
2. COLLECTOR
3. EMITTER
4. COLLECTOR</p> | <p>STYLE 4:
PIN 1. GATE
2. COLLECTOR
3. EMITTER
4. COLLECTOR</p> |
| <p>STYLE 5:
PIN 1. CATHODE
2. ANODE
3. GATE
4. ANODE</p> | <p>STYLE 6:
PIN 1. MAIN TERMINAL 1
2. MAIN TERMINAL 2
3. GATE
4. MAIN TERMINAL 2</p> | | |

- XXXXX = Specific Device Code
A = Assembly Location
Y = Year
WW = Work Week
G = Pb-Free Package

*This information is generic. Please refer to device data sheet for actual part marking. Pb-Free indicator, "G" or microdot "•", may or may not be present. Some products may not follow the Generic Marking.

DOCUMENT NUMBER:	98ASB15080C	Electronic versions are uncontrolled except when accessed directly from the Document Repository. Printed versions are uncontrolled except when stamped "CONTROLLED COPY" in red.
DESCRIPTION:	TO-247	PAGE 1 OF 1

onsemi and onsemi are trademarks of Semiconductor Components Industries, LLC dba onsemi or its subsidiaries in the United States and/or other countries. onsemi reserves the right to make changes without further notice to any products herein. onsemi makes no warranty, representation or guarantee regarding the suitability of its products for any particular purpose, nor does onsemi assume any liability arising out of the application or use of any product or circuit, and specifically disclaims any and all liability, including without limitation special, consequential or incidental damages. onsemi does not convey any license under its patent rights nor the rights of others.

onsemi, **Onsemi**, and other names, marks, and brands are registered and/or common law trademarks of Semiconductor Components Industries, LLC dba "**onsemi**" or its affiliates and/or subsidiaries in the United States and/or other countries. **onsemi** owns the rights to a number of patents, trademarks, copyrights, trade secrets, and other intellectual property. A listing of **onsemi**'s product/patent coverage may be accessed at www.onsemi.com/site/pdf/Patent-Marking.pdf. **onsemi** reserves the right to make changes at any time to any products or information herein, without notice. The information herein is provided "as-is" and **onsemi** makes no warranty, representation or guarantee regarding the accuracy of the information, product features, availability, functionality, or suitability of its products for any particular purpose, nor does **onsemi** assume any liability arising out of the application or use of any product or circuit, and specifically disclaims any and all liability, including without limitation special, consequential or incidental damages. Buyer is responsible for its products and applications using **onsemi** products, including compliance with all laws, regulations and safety requirements or standards, regardless of any support or applications information provided by **onsemi**. "Typical" parameters which may be provided in **onsemi** data sheets and/or specifications can and do vary in different applications and actual performance may vary over time. All operating parameters, including "Typicals" must be validated for each customer application by customer's technical experts. **onsemi** does not convey any license under any of its intellectual property rights nor the rights of others. **onsemi** products are not designed, intended, or authorized for use as a critical component in life support systems or any FDA Class 3 medical devices or medical devices with a same or similar classification in a foreign jurisdiction or any devices intended for implantation in the human body. Should Buyer purchase or use **onsemi** products for any such unintended or unauthorized application, Buyer shall indemnify and hold **onsemi** and its officers, employees, subsidiaries, affiliates, and distributors harmless against all claims, costs, damages, and expenses, and reasonable attorney fees arising out of, directly or indirectly, any claim of personal injury or death associated with such unintended or unauthorized use, even if such claim alleges that **onsemi** was negligent regarding the design or manufacture of the part. **onsemi** is an Equal Opportunity/Affirmative Action Employer. This literature is subject to all applicable copyright laws and is not for resale in any manner.

ADDITIONAL INFORMATION

TECHNICAL PUBLICATIONS:

Technical Library: www.onsemi.com/design/resources/technical-documentation
onsemi Website: www.onsemi.com

ONLINE SUPPORT: www.onsemi.com/support

For additional information, please contact your local Sales Representative at www.onsemi.com/support/sales