

NSM4002MR6

Dual NPN Transistors for Driving LEDs

NSM4002MR6 contains a single two NPN transistors. The base of the Q2 NPN transistor is internally connected to the collector of the Q1 NPN transistor. This device is designed to replace a discrete solution that is common for providing a constant current by integrating these two components into a single device. NSM4002MR6 is housed in a SC-74 package which is ideal for surface mount applications in space constrained applications.

Features

- Simplifies Circuit Design
- Reduces Board Space
- Reduces Component Count
- These Devices are Pb-Free, Halogen Free/BFR Free and are RoHS Compliant

Typical Applications

- LED Lighting
- Driver Circuits

MAXIMUM RATINGS Q₁ (T_A = 25°C)

Rating	Symbol	Value	Unit
Collector-Emitter Voltage	V _{CEO}	40	Vdc
Collector-Base Voltage	V _{CB0}	60	Vdc
Emitter-Base Voltage	V _{EBO}	6.0	Vdc
Collector Current - Continuous	I _C	200	mAdc

MAXIMUM RATINGS Q₂ (T_A = 25°C)

Rating	Symbol	Value	Unit
Collector-Emitter Voltage	V _{CEO}	45	Vdc
Collector-Base Voltage	V _{CB0}	50	Vdc
Emitter-Base Voltage	V _{EBO}	5.0	Vdc
Collector Current - Continuous	I _C	500	mAdc

Stresses exceeding those listed in the Maximum Ratings table may damage the device. If any of these limits are exceeded, device functionality should not be assumed, damage may occur and reliability may be affected.

THERMAL CHARACTERISTICS

Rating	Symbol	Max	Unit
Total Device Dissipation T _A = 25°C Derate above 25°C	P _D (Note 1)	260 2.08	mW mW/°C
Thermal Resistance, Junction-to-Ambient	R _{θJA} (Note 1)	480	°C/W
Total Device Dissipation T _A = 25°C Derate above 25°C	P _D (Note 2)	300 2.4	mW mW/°C
Thermal Resistance, Junction-to-Ambient	R _{θJA} (Note 2)	416	°C/W
Junction and Storage Temperature Range	T _J , T _{stg}	-55 to +150	°C

1. FR-4, 100 mm², 2 oz. Cu.
2. FR-4, 500 mm², 2 oz. Cu.



ON Semiconductor®

www.onsemi.com

Dual NPN Transistors for Driving LEDs

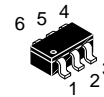
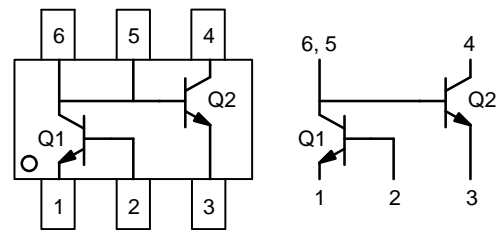

SC-74
CASE 318F

MARKING DIAGRAM

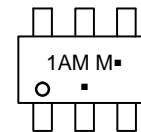

- 1AM = Device Code
- M = Date Code*
- = Pb-Free Package

(Note: Microdot may be in either location)
*Date Code orientation may vary depending upon manufacturing location.

ORDERING INFORMATION

Device	Package	Shipping†
NSM4002MR6T1G	SC-74 (Pb-Free)	3000 / Tape & Reel

†For information on tape and reel specifications, including part orientation and tape sizes, please refer to our Tape and Reel Packaging Specification Brochure, BRD8011/D.

NSM4002MR6

Table 1. ELECTRICAL CHARACTERISTICS Q₁ (T_A = 25°C, unless otherwise noted)

Characteristic	Symbol	Min	Max	Unit
OFF CHARACTERISTICS				
Collector–Emitter Breakdown Voltage (I _C = 1.0 mA, I _B = 0)	V _{(BR)CEO}	40	–	Vdc
Collector–Base Breakdown Voltage (I _C = 10 μA, I _E = 0)	V _{(BR)CBO}	60	–	Vdc
Emitter–Base Breakdown Voltage (I _E = 10 μA, I _C = 0)	V _{(BR)EBO}	6.0	–	Vdc
Collector Cutoff Current (V _{CE} = 30 Vdc, V _{EB(OFF)} = 3.0 Vdc)	I _{CEX}	–	50	nAdc
Base Cutoff Current (V _{CE} = 30 Vdc, V _{EB(OFF)} = 3.0 Vdc)	I _{BL}	–	50	nAdc
ON CHARACTERISTICS				
DC Current Gain (Note 3) (I _C = 100 μA, V _{CE} = 1.0 V) (I _C = 1.0 mA, V _{CE} = 1.0 V) (I _C = 10 mA, V _{CE} = 1.0 V) (I _C = 50 mA, V _{CE} = 1.0 V) (I _C = 100 mA, V _{CE} = 1.0 V)	h _{FE}	40 70 100 60 30	– – 300 – –	
Collector–Emitter Saturation Voltage (Note 3) (I _C = 10 mA, I _B = 1.0 mA) (I _C = 50 mA, I _B = 5.0 mA)	V _{CE(sat)}	– –	0.20 0.30	V
Base–Emitter Saturation Voltage (Note 3) (I _C = 10 mA, I _B = 1.0 mA) (I _C = 50 mA, I _B = 5.0 mA)	V _{BE(sat)}	0.65 –	0.85 0.95	V
Cutoff Frequency (I _C = 10 mA, V _{CE} = 20 V, f = 100 MHz)	f _T	300	–	MHz
Output Capacitance (V _{CB} = 5.0 V, f = 1.0 MHz)	C _{obo}	–	4.0	pF
Input Capacitance (V _{EB} = 0.5 V, f = 1.0 MHz)	C _{obo}	–	8.0	pF

Table 2. ELECTRICAL CHARACTERISTICS Q₂ (T_A = 25°C, unless otherwise noted)

Characteristic	Symbol	Min	Typ	Max	Unit
OFF CHARACTERISTICS					
Collector–Emitter Breakdown Voltage (I _C = 10 mA, I _B = 0)	V _{(BR)CEO}	45	–	–	Vdc
Collector–Base Breakdown Voltage (I _C = 10 μA, I _E = 0)	V _{(BR)CBO}	50	–	–	Vdc
Emitter–Base Breakdown Voltage (I _E = 1.0 μA, I _C = 0)	V _{(BR)EBO}	5.0	–	–	Vdc
Collector Cutoff Current (V _{CB} = 20 Vdc, I _E = 0)	I _{CBO}	–	–	0.1	μAdc
ON CHARACTERISTICS					
DC Current Gain (Note 3) (I _C = 100 mA, V _{CE} = 1.0 V) (I _C = 500 mA, V _{CE} = 1.0 V)	h _{FE}	250 40	– –	600 –	
Collector – Emitter Saturation Voltage (Note 3) (I _C = 500 mA, I _B = 50 mA)	V _{CE(sat)}	–	–	0.7	V
Base – Emitter Turn–on Voltage (Note 3) (I _C = 500 mA, V _{CE} = 1.0 V)	V _{BE(on)}	–	–	1.2	V
Cutoff Frequency (I _C = 10 mA, V _{CE} = 5.0 V, f = 100 MHz)	f _T	100	–	–	MHz
Output Capacitance (V _{CB} = 10 V, f = 1.0 MHz)	C _{obo}	–	10	–	pF

Product parametric performance is indicated in the Electrical Characteristics for the listed test conditions, unless otherwise noted. Product performance may not be indicated by the Electrical Characteristics if operated under different conditions.

3. Pulsed Condition: Pulse Width = 300 msec, Duty Cycle ≤ 2%.

NSM4002MR6

Application Section

Introduction

The NSM4002MR6 is designed to be used as a constant current driver for LEDs. The two resistors in Figure 1 are external from the NSM4002MR6 to allow for customization. R_{set} controls the current through the load, and R_1 controls the bias current.

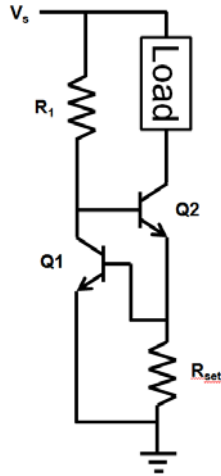

Figure 1. Typical Application Schematic

Selecting R_{set}

The R_{set} resistor is used to set the driving current of the load. It is connected across the Base–Emitter junction of Q1. This V_{BE} voltage is what sets up the constant voltage across the R_{set} resistor. Figure 5 gives the typical values of V_{BE}

based on the biasing current. To determine the R_{set} value simply divide the V_{BE} voltage by the desired driving current.

Selecting R_1

The R_1 resistor is used to set the biasing current. The biasing current is split between the base of Q2 and the collector of Q1. When desiring the lowest overhead voltage R_1 should be set as high as possible. It is important to ensure it is not set too high so that Q2 falls out of saturation. However, a lower R_1 value will drive more current through Q1. This will reduce the change in the driving current as temperature is increased. It will also allow a higher driving current to be achieved while maintaining good current regulation. The side affect of a lower R_1 value is that it reduces the overall efficiency because more power is being used in the driving circuit.

Input Voltage, V_s

The maximum input voltage, V_s , is determined by the load. No more than 45 V can be applied across Q2. This leads to:

$$V_{s(max)} = V_{Load} + 45 \text{ V} \quad (\text{eq. 1})$$

Overhead Voltage

The overhead voltage of this device to reach full current regulation is the combination of the V_{BE} voltages of the two transistors. Under typical conditions this overhead voltage will typically be 1.4 V.

NSM4002MR6

TYPICAL CHARACTERISTICS – Q1

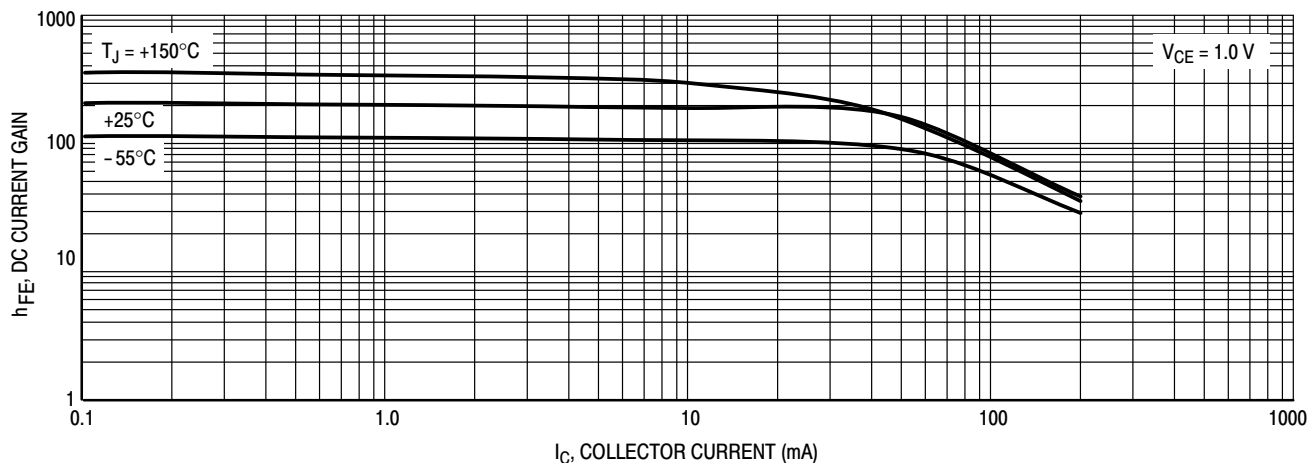

Figure 2. DC Current Gain

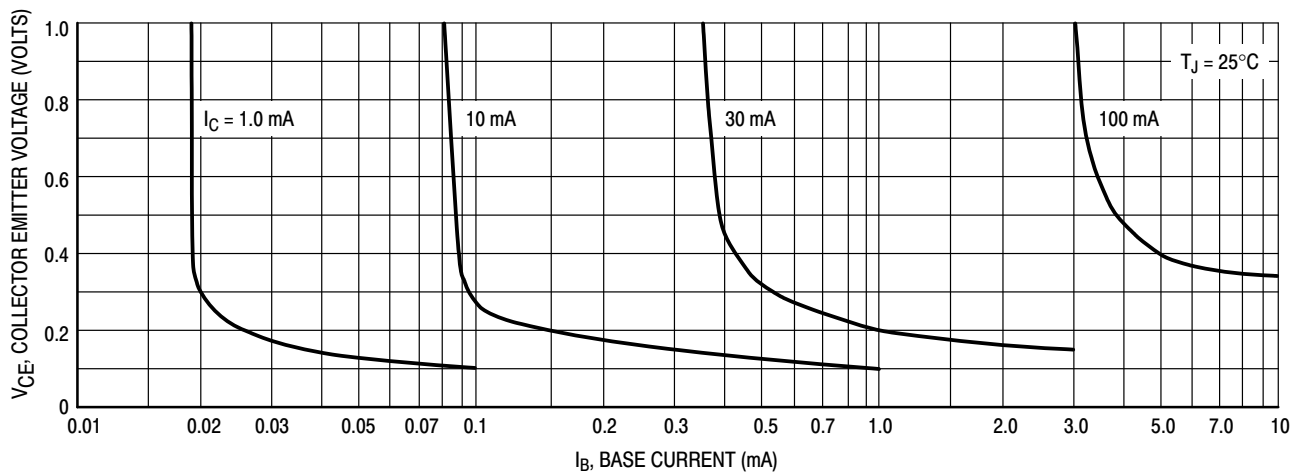

Figure 3. Collector Saturation Region

NSM4002MR6

TYPICAL CHARACTERISTICS – Q1

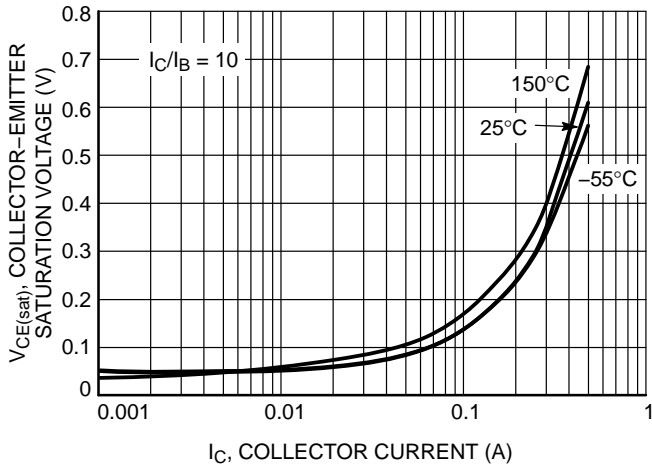

Figure 4. Collector Emitter Saturation Voltage vs. Collector Current

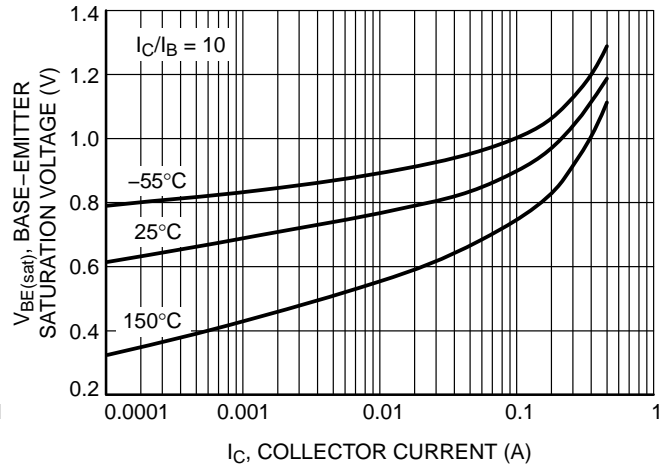

Figure 5. Base Emitter Saturation Voltage vs. Collector Current

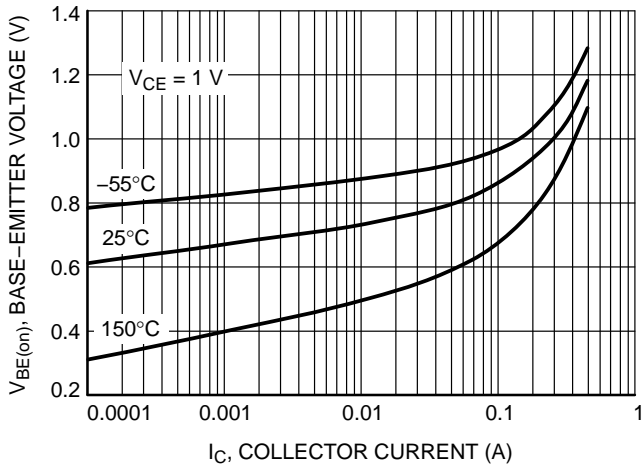

Figure 6. Base Emitter Voltage vs. Collector Current

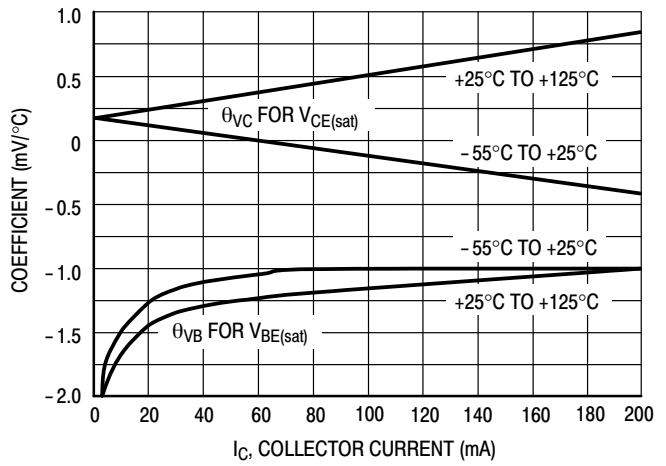

Figure 7. Temperature Coefficients

NSM4002MR6

TYPICAL CHARACTERISTICS – Q2

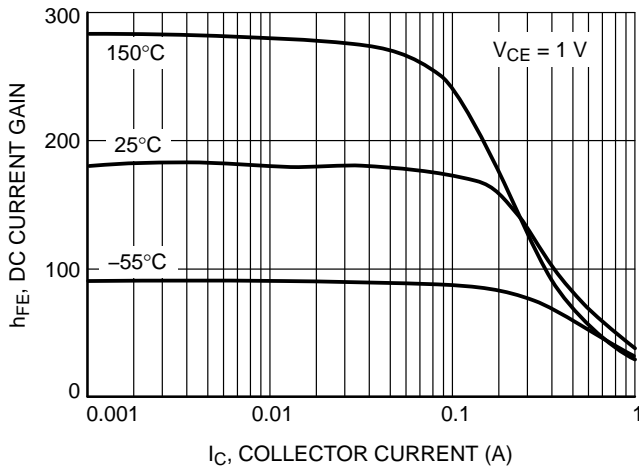

Figure 8. DC Current Gain vs. Collector Current

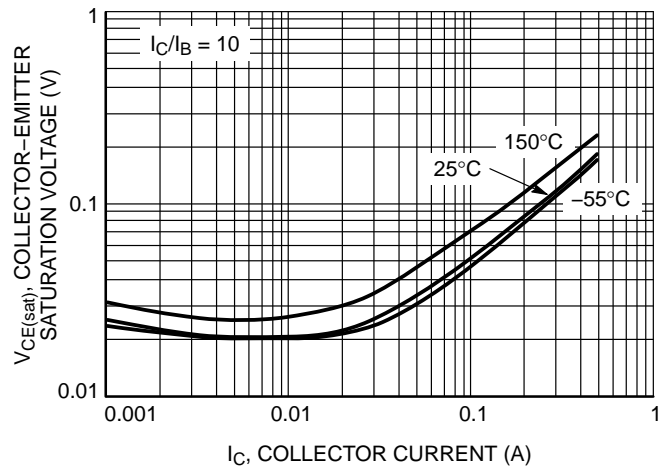

Figure 9. Collector Emitter Saturation Voltage vs. Collector Current

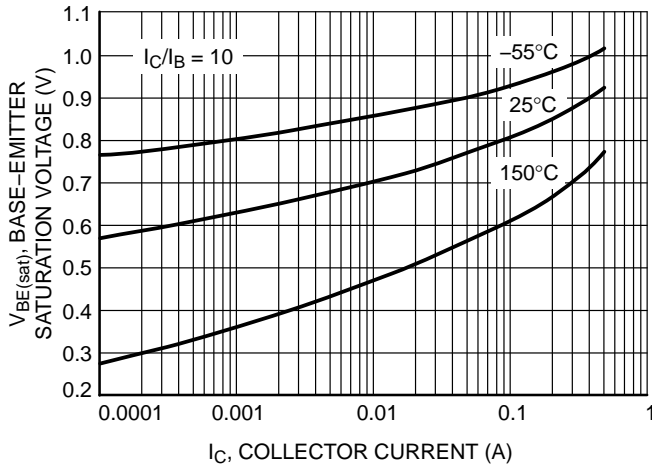

Figure 10. Base Emitter Saturation Voltage vs. Collector Current

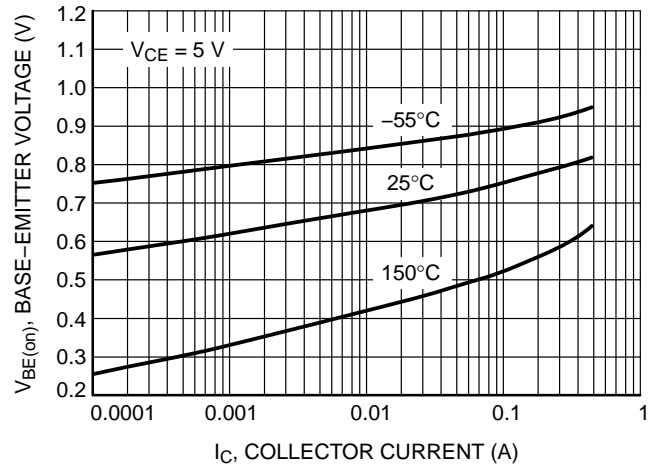

Figure 11. Base Emitter Voltage vs. Collector Current

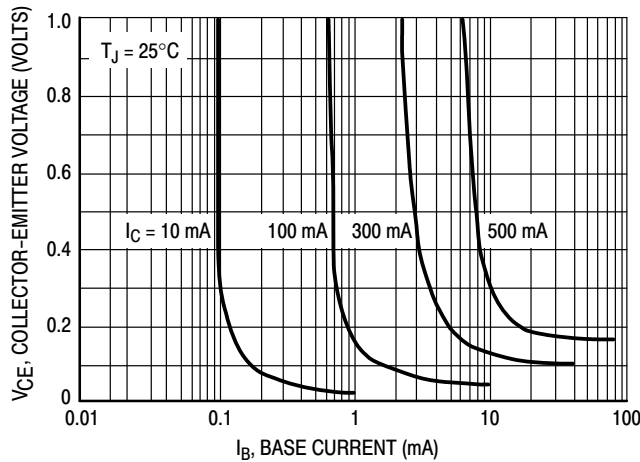

Figure 12. Saturation Region



SCALE 2:1

SC-74
CASE 318F
ISSUE P

DATE 07 OCT 2021

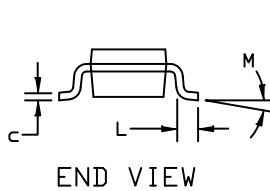
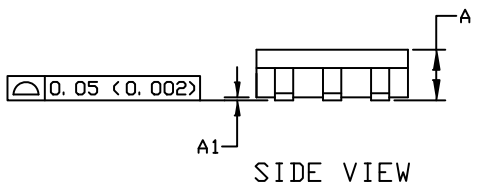
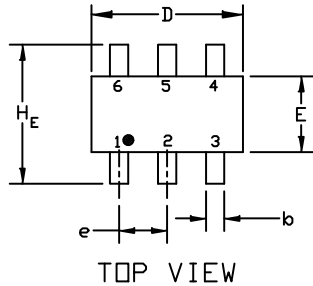

GENERIC
MARKING DIAGRAM*

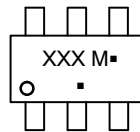

XXX = Specific Device Code
M = Date Code
▪ = Pb-Free Package

(Note: Microdot may be in either location)

*This information is generic. Please refer to device data sheet for actual part marking. Pb-Free indicator, "G" or microdot "▪", may or may not be present. Some products may not follow the Generic Marking.

NOTES:

1. DIMENSIONING AND TOLERANCING PER ASME Y14.5M, 1994
2. CONTROLLING DIMENSION: INCHES
3. MAXIMUM LEAD THICKNESS INCLUDES LEAD FINISH THICKNESS. MINIMUM LEAD THICKNESS IS THE MINIMUM THICKNESS OF THE BASE MATERIAL.

DIM	MILLIMETERS			INCHES		
	MIN.	NOM.	MAX.	MIN.	NOM.	MAX.
A	0.90	1.00	1.10	0.035	0.039	0.043
A1	0.01	0.06	0.10	0.001	0.002	0.004
b	0.25	0.37	0.50	0.010	0.015	0.020
c	0.10	0.18	0.26	0.004	0.007	0.010
D	2.90	3.00	3.10	0.114	0.118	0.122
E	1.30	1.50	1.70	0.051	0.059	0.067
e	0.85	0.95	1.05	0.034	0.037	0.041
HE	2.50	2.75	3.00	0.099	0.108	0.118
L	0.20	0.40	0.60	0.008	0.016	0.024
M	0*	---	10*	0*	---	10*

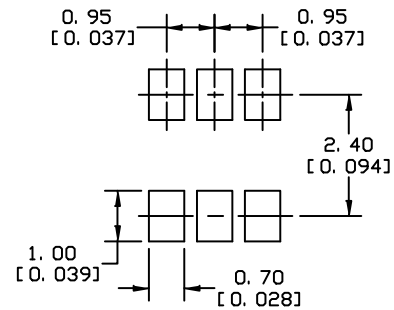

* For additional information on our Pb-Free strategy and soldering details, please download the DN Semiconductor Soldering and Mounting Techniques Reference Manual, SOLDERM/D.

SOLDERING FOOTPRINT

<p>STYLE 1: PIN 1. CATHODE 2. ANODE 3. CATHODE 4. CATHODE 5. ANODE 6. CATHODE</p>	<p>STYLE 2: PIN 1. NO CONNECTION 2. COLLECTOR 3. EMITTER 4. NO CONNECTION 5. COLLECTOR 6. BASE</p>	<p>STYLE 3: PIN 1. EMITTER 1 2. BASE 1 3. COLLECTOR 2 4. EMITTER 2 5. BASE 2 6. COLLECTOR 1</p>	<p>STYLE 4: PIN 1. COLLECTOR 2 2. EMITTER 1/EMITTER 2 3. COLLECTOR 1 4. EMITTER 3 5. BASE 1/BASE 2/COLLECTOR 3 6. BASE 3</p>	<p>STYLE 5: PIN 1. CHANNEL 1 2. ANODE 3. CHANNEL 2 4. CHANNEL 3 5. CATHODE 6. CHANNEL 4</p>	<p>STYLE 6: PIN 1. CATHODE 2. ANODE 3. CATHODE 4. CATHODE 5. CATHODE 6. CATHODE</p>
<p>STYLE 7: PIN 1. SOURCE 1 2. GATE 1 3. DRAIN 2 4. SOURCE 2 5. GATE 2 6. DRAIN 1</p>	<p>STYLE 8: PIN 1. EMITTER 1 2. BASE 2 3. COLLECTOR 2 4. EMITTER 2 5. BASE 1 6. COLLECTOR 1</p>	<p>STYLE 9: PIN 1. EMITTER 2 2. BASE 2 3. COLLECTOR 1 4. EMITTER 1 5. BASE 1 6. COLLECTOR 2</p>	<p>STYLE 10: PIN 1. ANODE/CATHODE 2. BASE 3. EMITTER 4. COLLECTOR 5. ANODE 6. CATHODE</p>	<p>STYLE 11: PIN 1. EMITTER 2. BASE 3. ANODE/CATHODE 4. ANODE 5. CATHODE 6. COLLECTOR</p>	

DOCUMENT NUMBER:	98ASB42973B	Electronic versions are uncontrolled except when accessed directly from the Document Repository. Printed versions are uncontrolled except when stamped "CONTROLLED COPY" in red.
DESCRIPTION:	SC-74	PAGE 1 OF 1

onsemi and ONSEMI are trademarks of Semiconductor Components Industries, LLC dba onsemi or its subsidiaries in the United States and/or other countries. onsemi reserves the right to make changes without further notice to any products herein. onsemi makes no warranty, representation or guarantee regarding the suitability of its products for any particular purpose, nor does onsemi assume any liability arising out of the application or use of any product or circuit, and specifically disclaims any and all liability, including without limitation special, consequential or incidental damages. onsemi does not convey any license under its patent rights nor the rights of others.

onsemi, **Onsemi**, and other names, marks, and brands are registered and/or common law trademarks of Semiconductor Components Industries, LLC dba "**onsemi**" or its affiliates and/or subsidiaries in the United States and/or other countries. **onsemi** owns the rights to a number of patents, trademarks, copyrights, trade secrets, and other intellectual property. A listing of **onsemi**'s product/patent coverage may be accessed at www.onsemi.com/site/pdf/Patent-Marking.pdf. **onsemi** reserves the right to make changes at any time to any products or information herein, without notice. The information herein is provided "as-is" and **onsemi** makes no warranty, representation or guarantee regarding the accuracy of the information, product features, availability, functionality, or suitability of its products for any particular purpose, nor does **onsemi** assume any liability arising out of the application or use of any product or circuit, and specifically disclaims any and all liability, including without limitation special, consequential or incidental damages. Buyer is responsible for its products and applications using **onsemi** products, including compliance with all laws, regulations and safety requirements or standards, regardless of any support or applications information provided by **onsemi**. "Typical" parameters which may be provided in **onsemi** data sheets and/or specifications can and do vary in different applications and actual performance may vary over time. All operating parameters, including "Typicals" must be validated for each customer application by customer's technical experts. **onsemi** does not convey any license under any of its intellectual property rights nor the rights of others. **onsemi** products are not designed, intended, or authorized for use as a critical component in life support systems or any FDA Class 3 medical devices or medical devices with a same or similar classification in a foreign jurisdiction or any devices intended for implantation in the human body. Should Buyer purchase or use **onsemi** products for any such unintended or unauthorized application, Buyer shall indemnify and hold **onsemi** and its officers, employees, subsidiaries, affiliates, and distributors harmless against all claims, costs, damages, and expenses, and reasonable attorney fees arising out of, directly or indirectly, any claim of personal injury or death associated with such unintended or unauthorized use, even if such claim alleges that **onsemi** was negligent regarding the design or manufacture of the part. **onsemi** is an Equal Opportunity/Affirmative Action Employer. This literature is subject to all applicable copyright laws and is not for resale in any manner.

ADDITIONAL INFORMATION

TECHNICAL PUBLICATIONS:

Technical Library: www.onsemi.com/design/resources/technical-documentation
onsemi Website: www.onsemi.com

ONLINE SUPPORT: www.onsemi.com/support

For additional information, please contact your local Sales Representative at www.onsemi.com/support/sales