

Powerex, Inc., 200 Hillis Street, Youngwood, Pennsylvania 15697-1800 (412) 925-7272  
 Powerex, Europe, S.A. 428 Avenue G. Durand, BP107, 72003 Le Mans, France (43) 41.14.14

**Phase Control SCR**  
 490 Amperes Average  
 2400 Volts

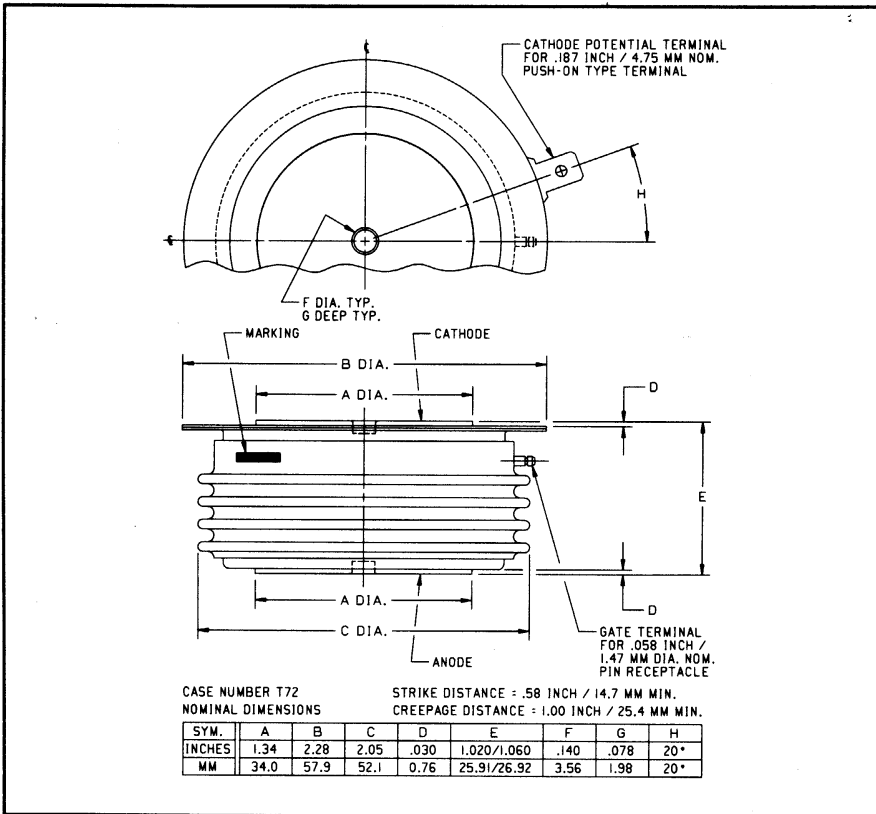

C391 (Outline Drawing)

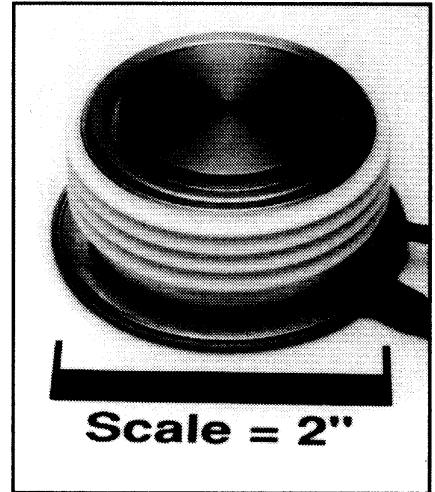

C391 Phase Control SCR  
 490 Amperes Average, 2400 Volts

### Description:

Powerex Silicon Controlled Rectifiers (SCR) are designed for phase control applications. These are all-diffused, Press-Pak (Pow-R-Disc) devices employing the field-proven amplifying (di/namic) gate.

### Features:

- Low On-State Voltage
- High di/dt
- High dv/dt
- Hermetic Packaging
- Excellent Surge and  $I^2t$  Ratings

### Applications:

- Power Supplies
- Battery Chargers
- Motor Control
- VAR Generators

### Ordering Information:

Select the complete six digit part number you desire from the table, i.e. C391LD is a 2400 Volt, 490 Ampere Phase Control SCR.

Type	Voltage		Current
	$V_{DRM}$	$V_{RRM}$ Code	$I_{T(av)}$
C391	1400	PD	490
	1600	PM	
	1800	PN	
	2000	L	
	2200	LB	
	2400	LD	



Powerex, Inc., 200 Hillis Street, Youngwood, Pennsylvania 15697-1800 (412) 925-7272  
 Powerex, Europe, S.A. 428 Avenue G. Durand, BP107, 72003 Le Mans, France (43) 41.14.14

C391

Phase Control SCR

490 Amperes Average, 2400 Volts

### Absolute Maximum Ratings

	Symbol	C391	Units
RMS On-State Current @ $T_C = 64^\circ\text{C}$	$I_{T(RMS)}$	770	Amperes
Average On-State Current @ $T_C = 64^\circ\text{C}$	$I_{T(av)}$	490	Amperes
Peak One-Cycle Surge (Non-Repetitive) On-State Current (60Hz)	$I_{TSM}$	8000	Amperes
Peak One-Cycle Surge (Non-Repetitive) On-State Current (50Hz)	$I_{TSM}$	7000	Amperes
Critical Rate-of-Rise of On-State Current (Non-Repetitive)	$di/dt$	150	Amperes/ $\mu\text{s}$
Critical Rate-of-Rise of On-State Current (Repetitive)	$di/dt$	75	Amperes/ $\mu\text{s}$
$I^2t$ (for Fusing), One Cycle at 60Hz	$I^2t$	265,000	$\text{A}^2\text{sec}$
Peak Gate Power Dissipation	$P_{GM}$	200	Watts
Average Gate Power Dissipation	$P_{G(av)}$	5	Watts
Storage Temperature	$T_{STG}$	-40 to +150	$^\circ\text{C}$
Operating Temperature	$T_J$	-40 to +125	$^\circ\text{C}$
Mounting Force		2000 to 2500	lb.
Mounting Force		8.9 to 11.1	kN

### Electrical and Thermal Characteristics

Characteristics	Symbol	Test Conditions	C391	Units
<b>Voltage—Blocking State Maximums</b>				
Forward Leakage, Peak	$I_{DRM}$	$T_J = 125^\circ\text{C}$ , Rated $V_{DRM}$	45	mA
Reverse Leakage, Peak	$I_{RRM}$	$T_J = 125^\circ\text{C}$ , Rated $V_{RRM}$	45	mA
<b>Current—Conducting State Maximums</b>				
Peak On-State Voltage	$V_{TM}$	$I_{TM} = 3000\text{A}$ Peak, Duty Cycle $\leq 0.01\%$ , $T_C = 25^\circ\text{C}$	2.65	Volts
<b>Switching</b>				
Typical Turn-Off Time	$t_q$	$T_J = 125^\circ\text{C}$ ; $I_{TM} = 500$ Amps; $V_R = 50$ Volts Min.; .8 $\times V_{DRM}$ (Reapplied); Rate-of-Rise of Reapplied Off-State Voltage = $20\text{V}/\mu\text{sec}$ (linear); Commutation $di/dt = 25$ Amps/ $\mu\text{sec}$ ; Repetition Rate = 1 pps; Gate Bias During Turn-Off Interval = 0 Volts, $100\Omega$	200	$\mu\text{sec}$
Typical Delay Time	$t_d$	$T_J = 25^\circ\text{C}$ , $I_{TM} = 50$ Adc, $V_{DRM}$ Rated. Gate Supply: 20 Volts, $20\Omega$ , $0.1 \mu\text{sec}$ Max. Rise Time	1	$\mu\text{sec}$
Min. Critical $dv/dt$ exponential to $V_{DRM}$	$dv/dt$	$0.8V_{DRM}$ Rated, $T_J = 125^\circ\text{C}$	200	$\text{V}/\mu\text{sec}$
<b>Thermal</b>				
Maximum Thermal Resistance, double sided cooling Junction to Case	$R_{\theta JC}$		0.06	$^\circ\text{C}/\text{Watt}$
Case to Sink, Lubricated	$R_{\theta CS}$		0.02	$^\circ\text{C}/\text{Watt}$
<b>Gate—Maximum Parameters</b>				
Gate Current to Trigger	$I_{GT}$	$V_D = 6\text{Vdc}$ , $T_C = 25^\circ\text{C}$ , $R_L = 3\Omega$	150	mA
Gate Voltage to Trigger	$V_{GT}$	$T_C = -40$ to $+125^\circ\text{C}$ , $V_D = 6\text{Vdc}$ , $R_L = 3\Omega$	5	Volts
Non-Triggering Gate Voltage	$V_{GDM}$	$V = \text{rated } V_{DRM}$ , $T_C = 125^\circ\text{C}$ , $R_L = 1000\Omega$	0.15	Volts
Peak Forward Gate Current	$I_{GTM}$		10	Amperes
Peak Reverse Gate Voltage	$V_{GRM}$		5	Volts

Powerex, Inc., 200 Hillis Street, Youngwood, Pennsylvania 15697-1800 (412) 925-7272  
 Powerex, Europe, S.A. 428 Avenue G. Durand, BP107, 72003 Le Mans, France (43) 41.14.14

C391  
 Phase Control SCR  
 490 Amperes Average, 2400 Volts

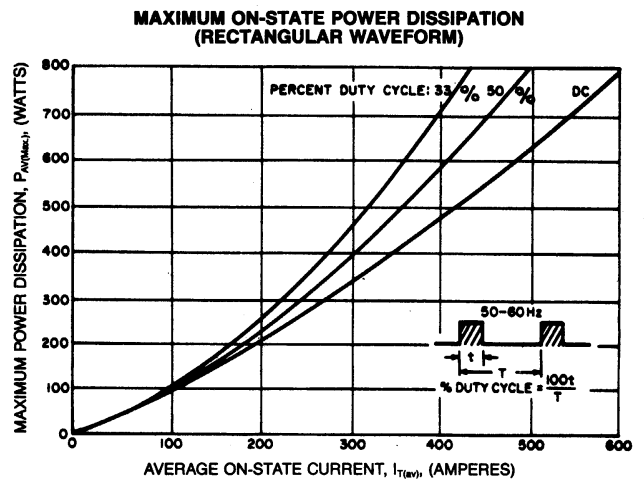
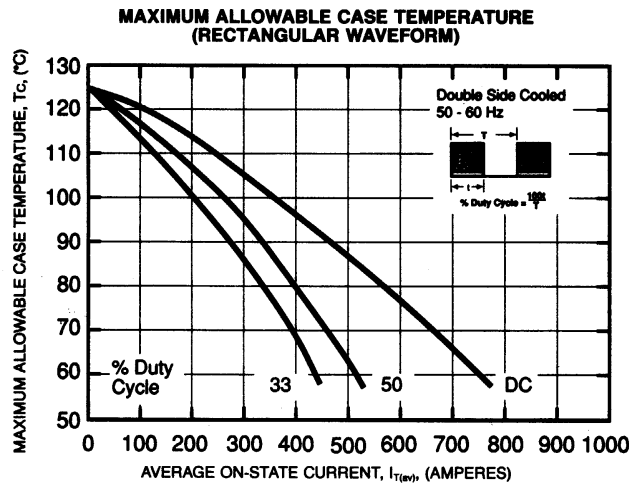
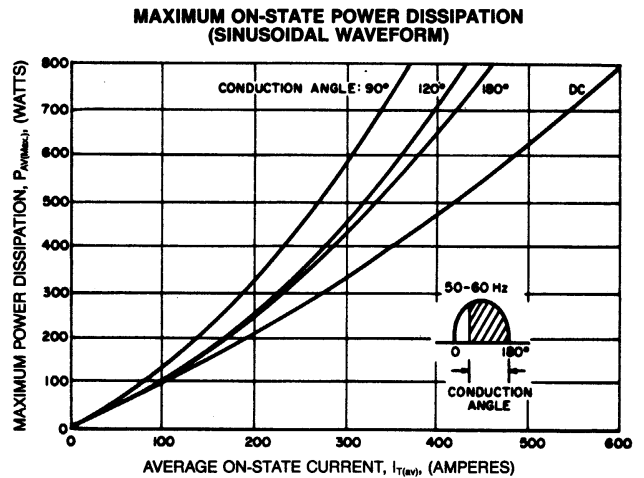
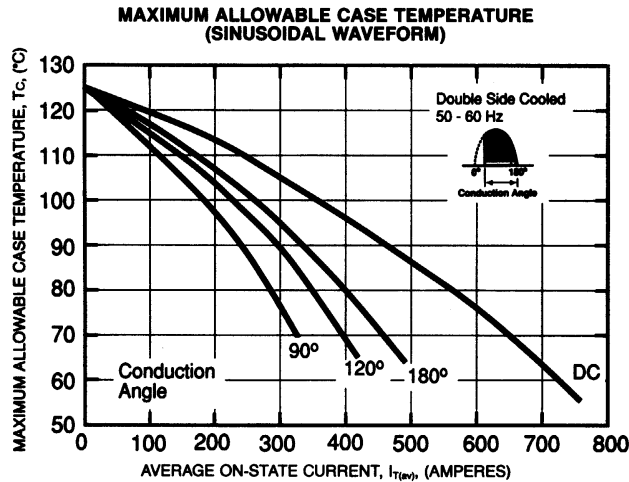
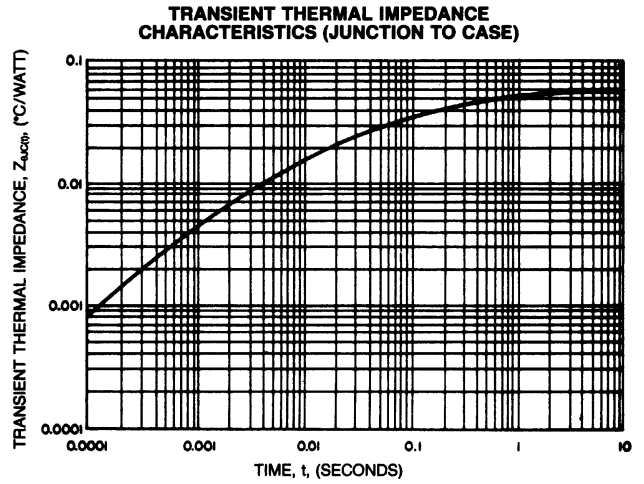
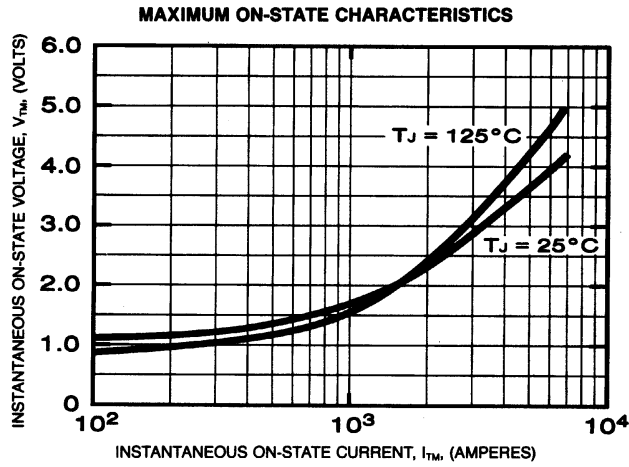

Powerex, Inc., 200 Hillis Street, Youngwood, Pennsylvania 15697-1800 (412) 925-7272  
 Powerex, Europe, S.A. 428 Avenue G. Durand, BP107, 72003 Le Mans, France (43) 41.14.14

**C391**  
**Phase Control SCR**  
 490 Amperes Average, 2400 Volts

**MAXIMUM ALLOWABLE CASE TEMPERATURE (SINUSOIDAL WAVEFORM)**

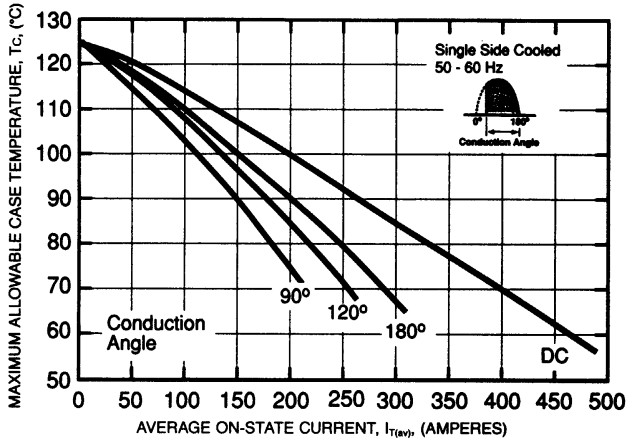

**MAXIMUM ALLOWABLE CASE TEMPERATURE (RECTANGULAR WAVEFORM)**

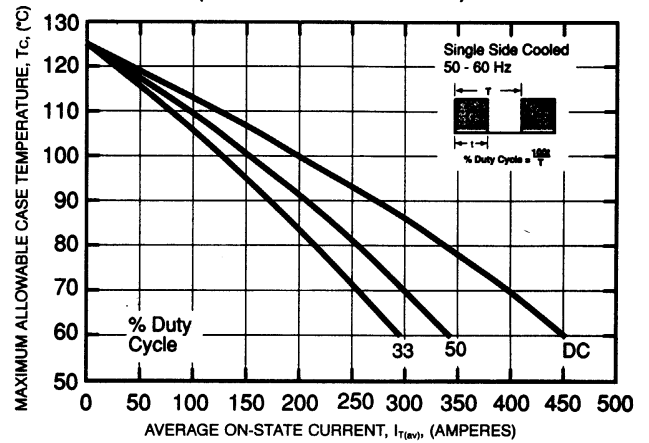

**MAXIMUM ON-STATE POWER DISSIPATION (SINUSOIDAL WAVEFORM — EXTENDED)**

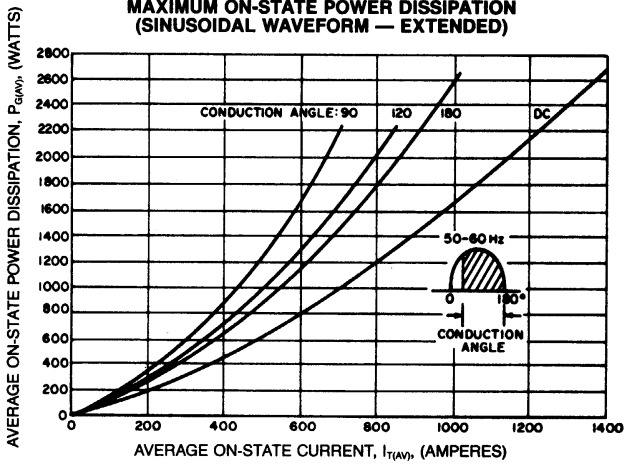

**MAXIMUM ON-STATE POWER DISSIPATION (RECTANGULAR WAVEFORM — EXTENDED)**

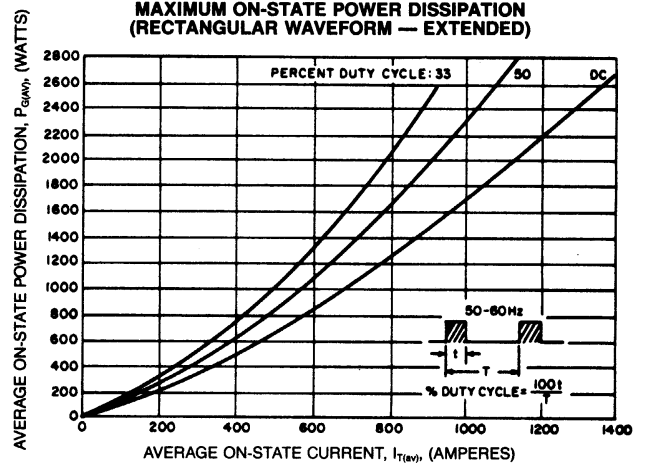

**SUB-CYCLE SURGE AND  $I^2t$  RATINGS (RATED LOAD CONDITIONS)**

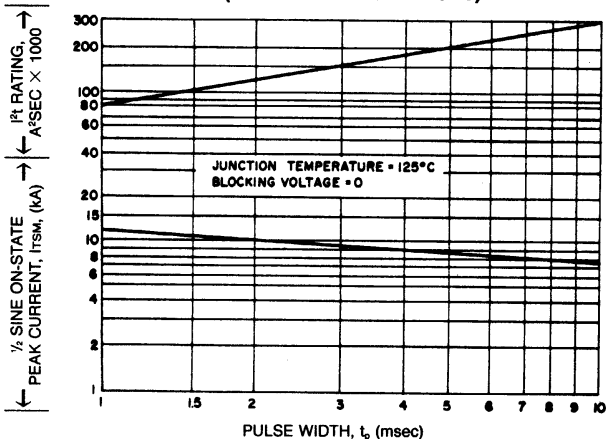

**GATE CHARACTERISTICS**

