

Fast Switching SCR T727_48

475A Avg.
(750 RMS)
Up to 800 Volts
10-50 μ s

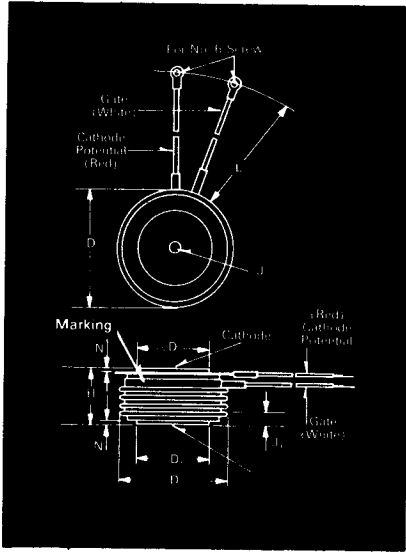

Symbol	Inches		Millimeters	
	Min.	Max.	Min.	Max.
ϕD	2.250	2.290	57.15	58.17
ϕD_1	1.333	1.343	33.86	34.11
ϕD_2	2.030	2.090	51.56	53.09
H	1.020	1.060	25.91	26.92
ϕJ	.135	.145	3.43	3.68
J_1	.075	.090	1.91	2.29
L	7.75	8.50	196.85	215.90
N	.040		1.02	

Creep Distance—1.00 in. min. (25.40 mm).
Strike Distance—.69 in. min. (17.53 mm).
(In accordance with NEMA standards.)
Finish—Nickel Plate.
Approx. Weight—8 oz. (227 g).
1. Dimension "H" is a clamped dimension.

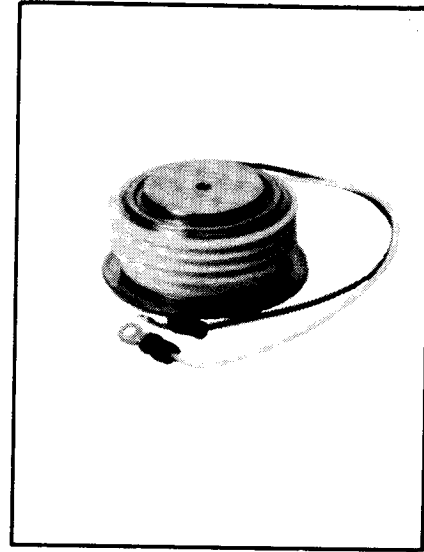

T72 Outline

Features:

- Center fired di/namic gate
- High di/dt with soft gate control
- High frequency operation
- Sinusoidal waveform operation to 20KHz
- Rectangular waveform operation to 20KHz
- Low dynamic forward voltage drop
- Low switching losses at high frequency
- Lifetime Guarantee

Applications:

- Inverters
UPS
Induction heating
AC motor drives
- Cycloconverters
- Choppers
- Crowbars

Ordering Information

Type	Voltage		Current		Turn-off		Gate current		Leads			
	Code	V _{DRM} and V _{RRM} (V)	Code	I _{T(av)} (A)	Code	t _q usec	Code	I _{GT} (ma)	Case	Code		
T727		100	01	475	48	10	8	150	4	T72	DN	
		200	02			15						7
		300	03			20						6
		400	04			25						5
		500	05			30						4
		600	06			40						3
		700	07			50						
		800	08									

Example

Obtain optimum device performance for your application by selecting proper Order Code.

Type T727 rated at 475 A average with V_{DRM} = 600V.
I_{GT} = 150 ma, t_q = 30 μ sec max. and standard control leads—order as:

Type	Voltage	Current	Turn Off	Gate Current	Leads
T 7 2 7	0 6	4 8	5	4	D N

FAST SWITCHING
THYRISTORS

475A Avg.
(750 RMS)
Up to 800 Volts
10-50 μ s

Fast Switching
SCR
T727_48

Voltage

Blocking State Maximums ^② ($T_J = 125^\circ\text{C}$)

	Symbol
Repetitive peak forward blocking voltage, V	V_{DRM}
Repetitive peak reverse voltage, V	V_{RRM}
Non-repetitive transient peak reverse voltage, $t \leq 5.0$ msec, V	V_{RSM}
Forward leakage current, mA peak	I_{DRM}
Reverse leakage current, mA peak	I_{RRM}

100	200	300	400	500	600	700	800
100	200	300	400	500	600	700	800
200	300	400	500	600	700	800	900
				30			
				30			

Current

Conducting State Maximums
($T_J = 125^\circ\text{C}$)

	Symbol	T727--48
RMS forward current, A	$I_{T(rms)}$	750
Ave. forward current, A	$I_{T(av)}$	475
One-half cycle surge current ^③ , A	I_{TSM}	8000
I^2t for fusing (for times ≥ 8.3 ms) A ² sec.	I^2t	265,000
Forward voltage drop at $I_{TM} = 3000$ A and $T_J = 25^\circ\text{C}$, V	V_{TM}	2.30
Min. repetitive di/dt A/ μ sec ^{①④⑤}	di/dt	400

Switching

($T_J = 25^\circ\text{C}$)

	Symbol	
Max. turn-off time, $I_T = 400$ A $T_J = 125^\circ\text{C}$, $di_R/dt = 25$ A/ μ sec, reappplied $dv/dt = 20$ V/ μ sec linear to $0.8 V_{DRM}$, μ sec ^{④⑤}	t_q	10 to 50
Typ. turn-on-time, $I_T = 1000$ A $V_D = 300$ V ^④ , μ sec	t_{on}	3.0
Min. critical dv/dt , exponential to V_{DRM} $T_J = 125^\circ\text{C}$, V/ μ sec ^{②⑥}	dv/dt	300
Min. di/dt non-repetitive, A/ μ sec ^{①④⑤}	di/dt	800

Gate

Maximum Parameters
($T_J = 25^\circ\text{C}$)

	Symbol	
Gate current to trigger at $V_D = 12$ V, mA	I_{GT}	150
Gate voltage to trigger at $V_D = 12$ V, V	V_{GT}	3
Non-triggering gate voltage, $T_J = 125^\circ\text{C}$, and rated V_{DRM} , V	V_{GDM}	0.15
Peak forward gate current, A	I_{GTM}	4
Peak reverse gate voltage, V	V_{GRM}	5
Peak gate power, Watts	P_{GM}	16
Average gate power, Watts	$P_{G(av)}$	3

Thermal and Mechanical

	Symbol	
Min., Max. oper. junction temp., $^\circ\text{C}$	T_J	-40 to +125
Min., Max. storage temp., $^\circ\text{C}$	T_{stg}	-40 to +150
Max. mounting torque, in lb. ^①		2000 to 2400
Max. Thermal resistance ^① Double side cooled junction to case, $^\circ\text{C}/\text{Watt}$	$R_{\theta JC}$.06
Case to sink, lubricated, $^\circ\text{C}/\text{Watt}$	$R_{\theta CS}$.02

- ① Consult recommended mounting procedures.
- ② Applies for zero or negative gate bias.
- ③ Per JEDEC RS-397, 5.2.2.1.
- ④ With recommended gate drive.
- ⑤ Higher dv/dt ratings available, consult factory.
- ⑥ Per JEDEC standard RS-397, 5.2.2.6.
- ⑦ For operation with antiparallel diode, consult factory.

Maximum Forward Voltage Drop VS Forward Current

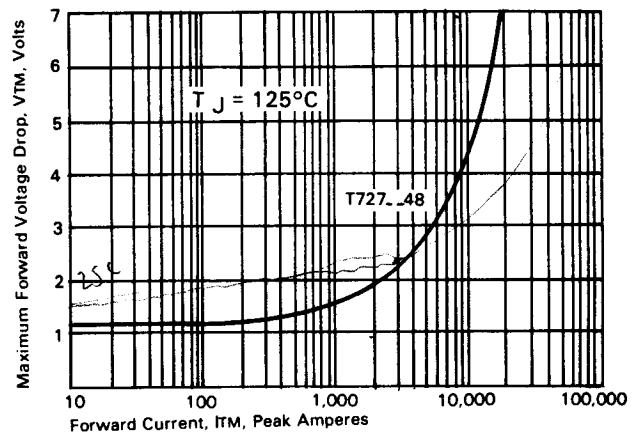

Transient Thermal Impedance VS. Time

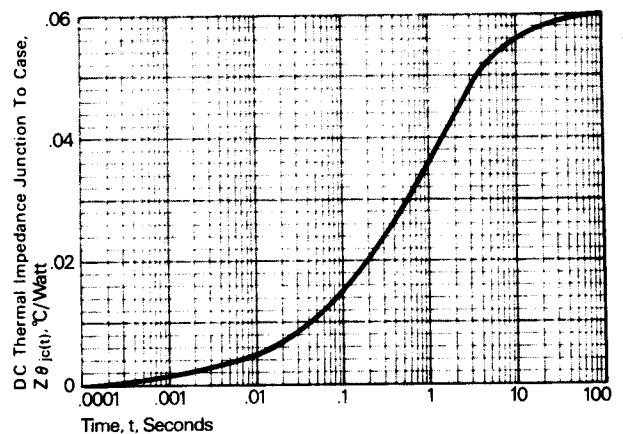

FAST SWITCHING
THYRISTORS

Fast Switching SCR T727_48

475A Avg.
(750 RMS)
Up to 800 Volts
10-50 μ s

Sinusoidal Current Data

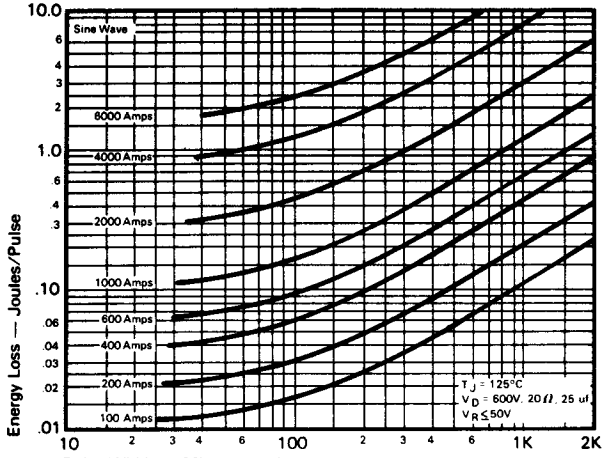

ENERGY PER PULSE FOR SINUSOIDAL PULSES

Trapezoidal Wave Current Data

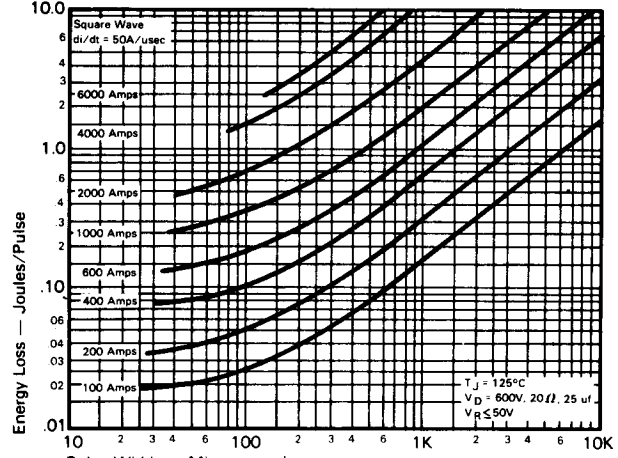

ENERGY PER PULSE FOR TRAPEZOIDAL PULSES
($di/dt = 50\text{A}/\mu\text{sec}$)

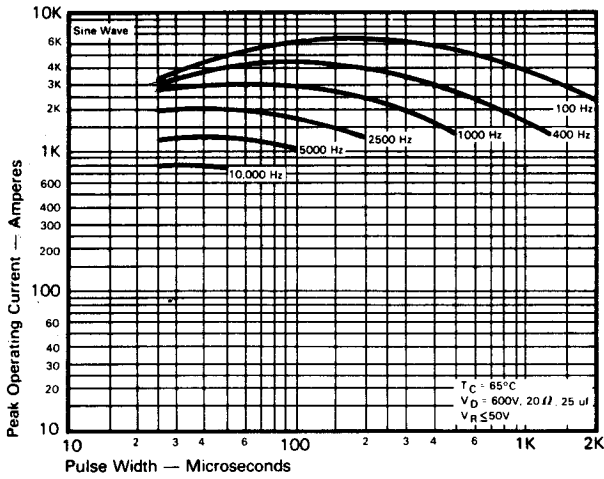

MAXIMUM ALLOWABLE PEAK ON-STATE CURRENT
vs. PULSE WIDTH ($T_C = 65^\circ\text{C}$)

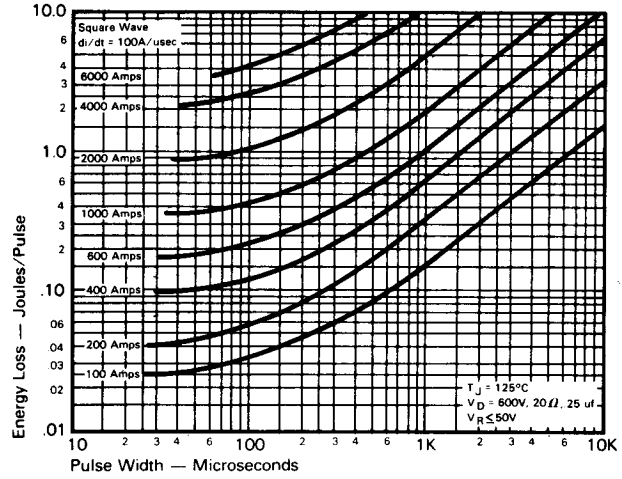

ENERGY PER PULSE FOR TRAPEZOIDAL PULSES
($di/dt = 100\text{A}/\mu\text{sec}$)

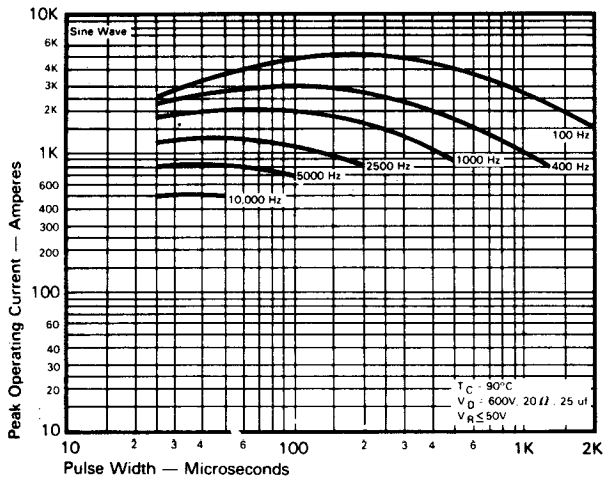

MAXIMUM ALLOWABLE PEAK ON-STATE CURRENT
vs. PULSE WIDTH ($T_C = 90^\circ\text{C}$)

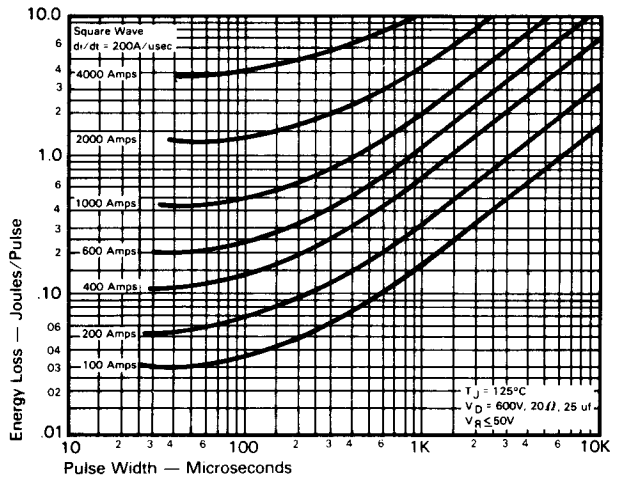

ENERGY PER PULSE FOR TRAPEZOIDAL PULSES
($di/dt = 200\text{A}/\mu\text{sec}$)

FAST SWITCHING
THYRISTORS

475A Avg.
(750 RMS)
Up to 800 Volts
10-50 μ s

Fast Switching
SCR
T727_48

Trapezoidal Wave Current Data
($T_C = 65^\circ\text{C}$)

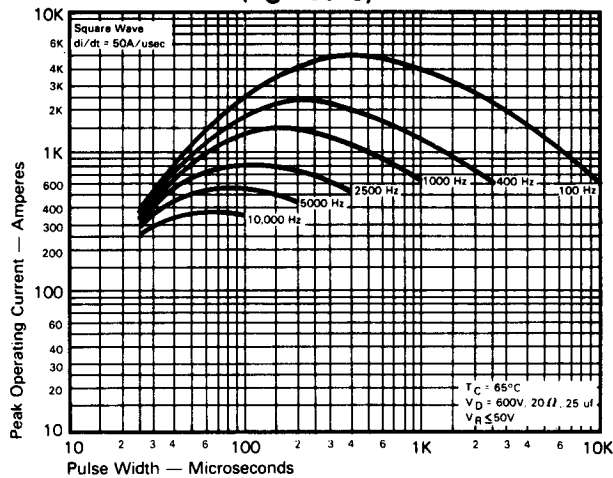

MAXIMUM ALLOWABLE PEAK ON-STATE CURRENT vs. PULSE WIDTH ($di/dt = 50A/us$)

Trapezoidal Wave Current Data
($T_C = 90^\circ\text{C}$)

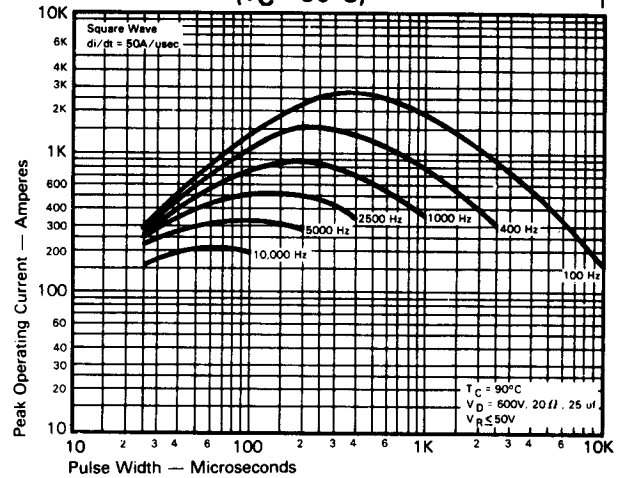

MAXIMUM ALLOWABLE PEAK ON-STATE CURRENT vs. PULSE WIDTH ($di/dt = 50A/us$)

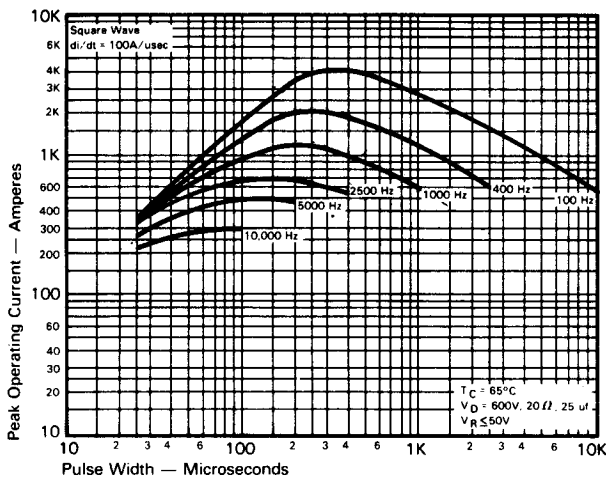

MAXIMUM ALLOWABLE PEAK ON-STATE CURRENT vs. PULSE WIDTH ($di/dt = 100A/us$)

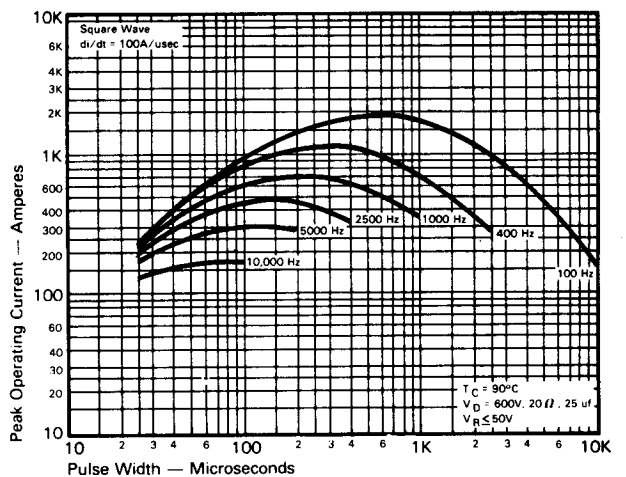

MAXIMUM ALLOWABLE PEAK ON-STATE CURRENT vs. PULSE WIDTH ($di/dt = 100A/us$)

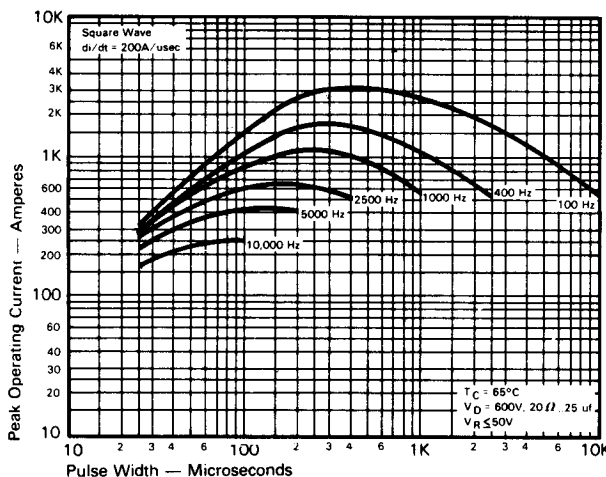

MAXIMUM ALLOWABLE PEAK ON-STATE CURRENT vs. PULSE WIDTH ($di/dt = 200A/us$)

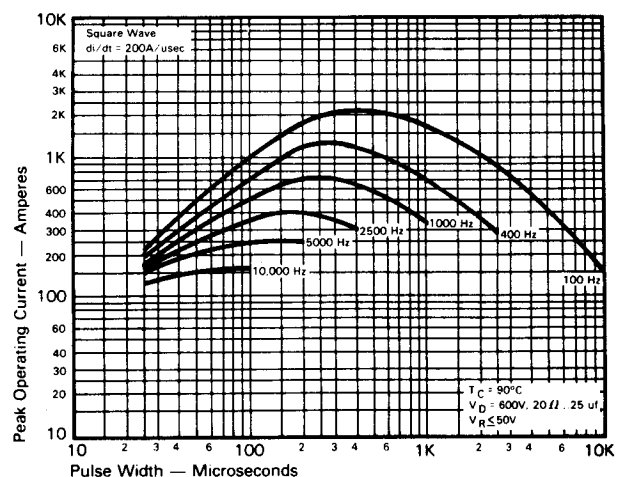

MAXIMUM ALLOWABLE PEAK ON-STATE CURRENT vs. PULSE WIDTH ($di/dt = 200A/us$)

FAST SWITCHING
THYRISTORS