

Fast Switching SCR T627__20

200A Avg.
(315 RMS)
Up to 1200 Volts
10-50 μ s

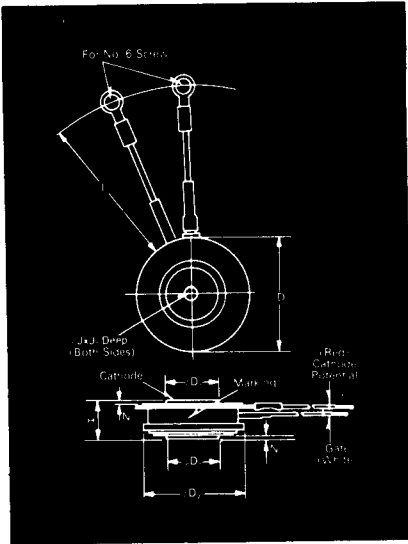

Symbol	Inches		Millimeters	
	Min.	Max.	Min.	Max.
ϕD	1.610	1.650	40.89	41.91
ϕD_1	.745	.755	18.92	19.18
ϕD_2	1.420	1.460	36.07	37.08
H	.500	.560	12.70	14.22
ϕJ	.135	.145	3.43	3.68
J_1	.072	.082	1.83	2.08
L	7.75	8.50	196.85	215.90
N	.030		.76	

Creep Distance—.34 in. min. (8.64 mm).

Strike Distance—.26 in. min. (6.60 mm).

(In accordance with NEMA standards.)

Finish—Nickel Plate.

Approx. Weight—2.3 oz. (66 g).

1. Dimension "H" is clamped dimension.

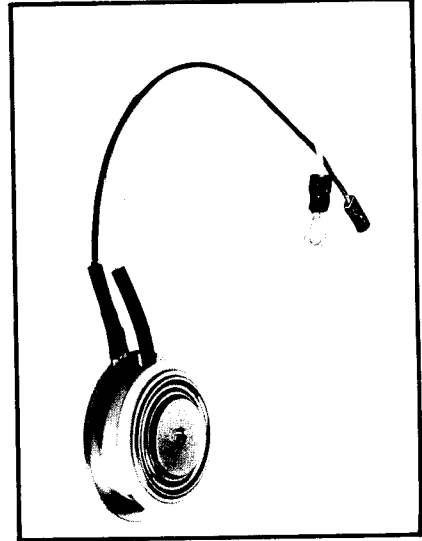

T62 Outline

Features:

- Center fired di/dynamic gate
- High di/dt with soft gate control
- High frequency operation
- Sinusoidal waveform operation to 20 KHz
- Rectangular waveform operation to 20 KHz
- Low dynamic forward voltage drop
- Low switching losses at high frequency

Applications:

- Inverters for
 - Ups
 - Induction Heating
 - Motor Control
- Choppers
- Crowbars

Ordering Information

Type	Voltage		Current		Turn-off		Gate Current		Leads		
Code	V_{DRM} and V_{RRM} (V)	Code	$I_T(av)$ (A)	Code	t_q μ sec	Code	I_{GT} (ma)	Code	Case	Code	
T627	100	01	200	20	10	6	150	4	T62	DN	
	200	02			15						7
	300	03			20						8
	400	04			30						8
	500	05			40						4
	600	06			50						3
	700	07									
	800	08									
	900	09									
	1000	10									
	1100	11									
	1200	12									

Example

Obtain optimum device performance for your application by selecting proper Order Code.

Type T627 rated at 200A average with $V_{DRM} = 1000V$, $I_{GT} = 150$ ma, $t_q = 20 \mu$ sec max. and flex leads—order as:

Type	Voltage	Current	Turn Off	Gate Current	Leads
T 6 2 7	1 0	2 0	6	4	D N

*for 10 μ sec turn-off, consult factory

**200A Avg.
(315 RMS)
Up to 1200 Volts
10-50 μ s**

**Fast Switching
SCR
T627_20**

Voltage

Blocking State Maximums (1) ($T_J = 125^\circ\text{C}$)

Repetitive peak forward blocking voltage, V	V_{DRM}
Repetitive peak reverse voltage, V	V_{RRM}
Non-repetitive transient peak reverse voltage, $t \leq 5.0$ msec, V	V_{RSM}
Forward leakage current, mA peak	I_{DRM}
Reverse leakage current, mA peak	I_{RRM}

100	200	300	400	500	600	700	800	900	1000	1100	1200
100	200	300	400	500	600	700	800	900	1000	1100	1200
200	300	400	500	600	700	800	900	1000	1100	1200	1300

Current

Conducting State Maximums
($T_J = 125^\circ\text{C}$)

Symbol	T627_20
RMS forward current, A	$I_T(\text{rms})$ 315
Ave. forward current, A	$I_T(\text{av})$ 200
One-half cycle surge current(3), A	I_{TSM} 4000
I^2t for fusing (for times ≥ 8.3 ms) A ² sec.	I^2t 65,000
Forward voltage drop at $I_{TM} = 625\text{A}$ and $T_J = 25^\circ\text{C}$, V	V_{TM} 2.1
Min. repetitive di/dt(4), A/ μ sec(1)(4)(5)	di/dt 250

Switching

($T_J = 25^\circ\text{C}$)

Symbol	
Max. turn-off time, $I_T = 150\text{A}$, $T_J = 125^\circ\text{C}$, $di/dt = 12.5$ (1) A/ μ sec, reapplied $dv/dt = 20\text{V}/\mu$ sec (5) linear to $0.8 V_{DRM}$, μ sec.	t_q 10 to 50
Typ. turn-on-time, $I_T = 100\text{A}$, $V_D = 100\text{V}$ (4), μ sec	t_{on} 3.5
Min. critical dv/dt , exponential to V_{DRM} , $T_J = 125^\circ\text{C}$, V/ μ sec(2)(5)	dv/dt 300
Min. di/dt A/ μ sec (1)(4)(5)	di/dt 800

Gate

Maximum Parameters
($T_J = 25^\circ\text{C}$)

Symbol	
Gate current to trigger at $V_D = 12\text{V}$, mA	I_{GT} 150
Gate voltage to trigger at $V_D = 12\text{V}$, V	V_{GT} 3
Non-triggering gate voltage, $T_J = 125^\circ\text{C}$, and rated V_{DRM} , V	V_{GDM} 0.15
Peak forward gate current, A	I_{GTM} 4
Peak reverse gate voltage, V	V_{GRM} 5
Peak gate power, Watts	P_{GM} 16
Average gate power, Watts	$P_{G(av)}$ 3

Thermal and Mechanical

Symbol	
Min., Max. oper. junction temp., $^\circ\text{C}$	T_J -40 to +125
Min., Max. storage temp., $^\circ\text{C}$	T_{stg} -40 to +150
Min., Max. Mounting Force, lb.(1)	1000 to 1400
Max. thermal resistance, Double side cooled Junction to case, $^\circ\text{C}/\text{Watt}$	$R_{\theta JC}$.08
Case to sink, lubricated, $^\circ\text{C}/\text{Watt}$	$R_{\theta CS}$.02

- (1) Consult recommended mounting procedures.
- (2) Applies for zero or negative gate bias.
- (3) Per JEDEC RS-397, 5.2.2.1.
- (4) With recommended gate drive.
- (5) Higher dv/dt ratings available, consult factory.
- (6) Per JEDEC standard RS-397, 5.2.2.6.
- (7) For operation with antiparallel diode, consult factory.

Maximum Forward Voltage VS. Forward Current

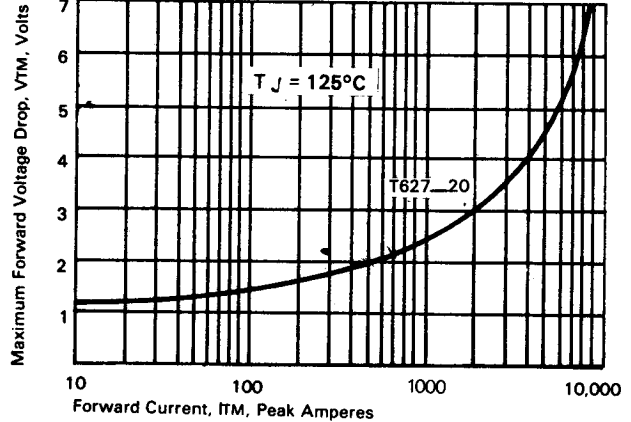

Transient Thermal Impedance vs. Time

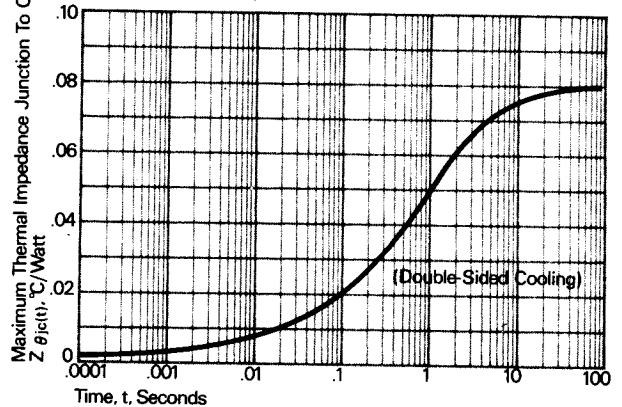

FAST SWITCHING THYRISTORS

Fast Switching SCR T627-20

200A Avg.
(315 RMS)
Up to 1200 Volts
10-50 μ s

Sinusoidal Current Data

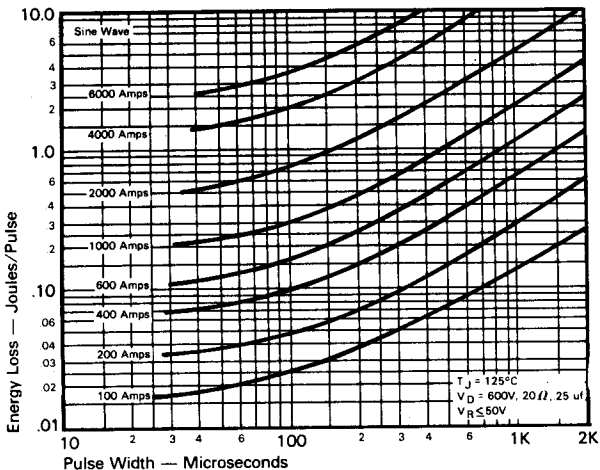

ENERGY PER PULSE FOR SINUSOIDAL PULSES

Trapezoidal Wave Current Data

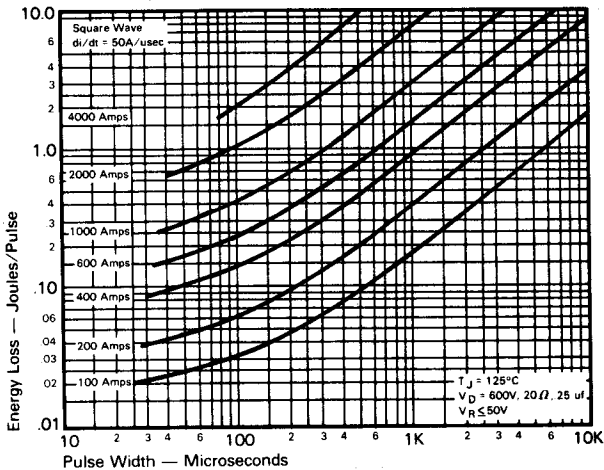

ENERGY PER PULSE FOR TRAPEZOIDAL PULSES
($di/dt = 50\text{A/usec}$)

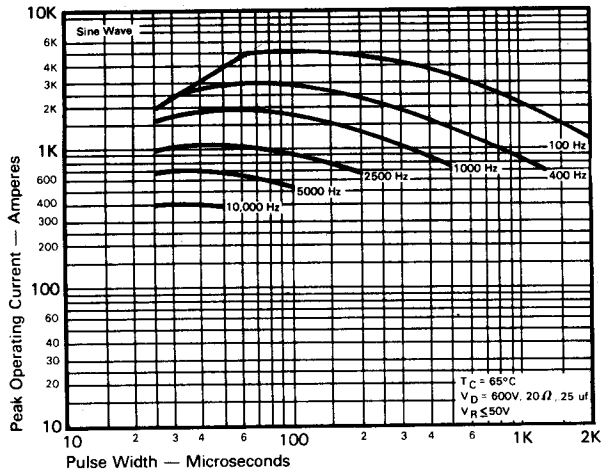

MAXIMUM ALLOWABLE PEAK ON-STATE CURRENT
vs. PULSE WIDTH ($T_C = 65^\circ\text{C}$)

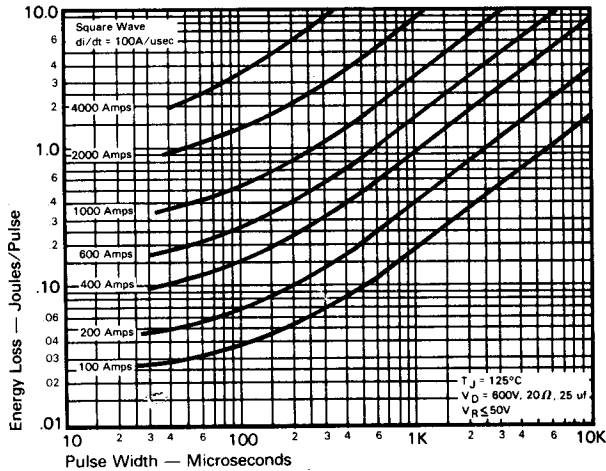

ENERGY PER PULSE FOR TRAPEZOIDAL PULSES
($di/dt = 100\text{A/usec}$)

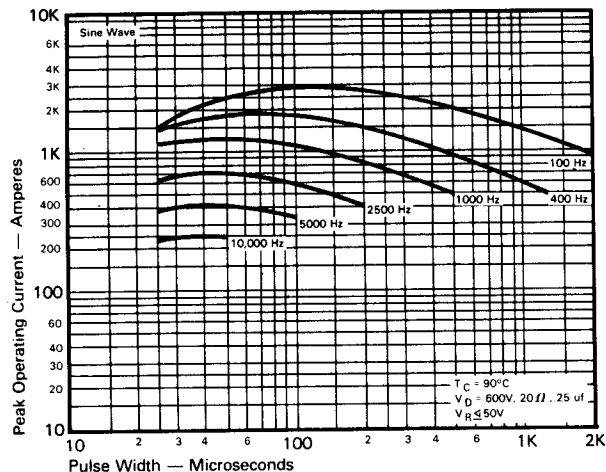

MAXIMUM ALLOWABLE PEAK ON-STATE CURRENT
vs. PULSE WIDTH ($T_C = 90^\circ\text{C}$)

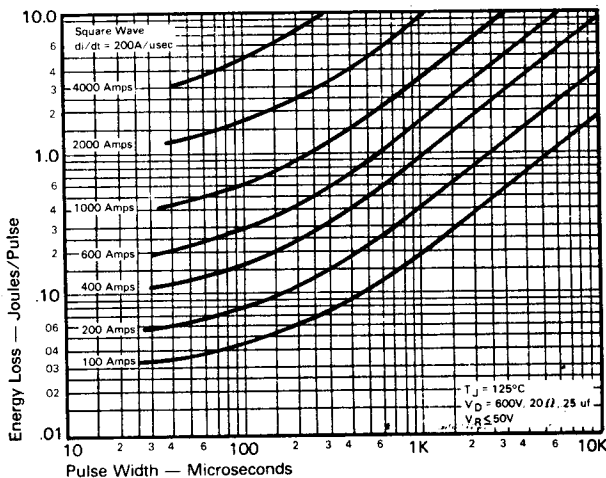

ENERGY PER PULSE FOR TRAPEZOIDAL PULSES
($di/dt = 200\text{A/usec}$)

200A Avg.
(315 RMS)
Up to 1200 Volts
10-50 μ s

Fast Switching
SCR
T627-20

Trapezoidal Wave Current Data
($T_C = 65^\circ\text{C}$)

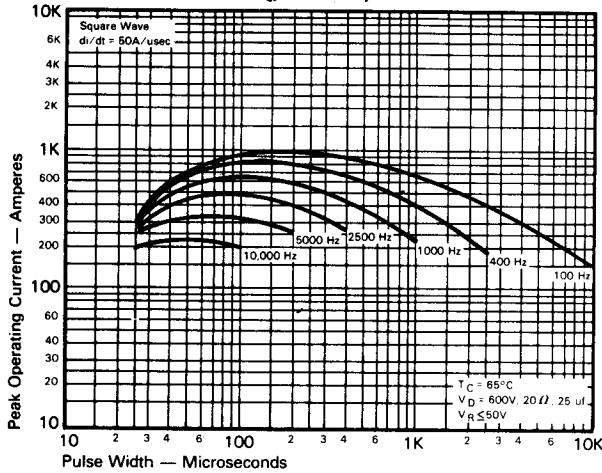

MAXIMUM ALLOWABLE PEAK ON-STATE CURRENT vs. PULSE WIDTH ($di/dt = 50A/us$)

Trapezoidal Wave Current Data
($T_C = 90^\circ\text{C}$)

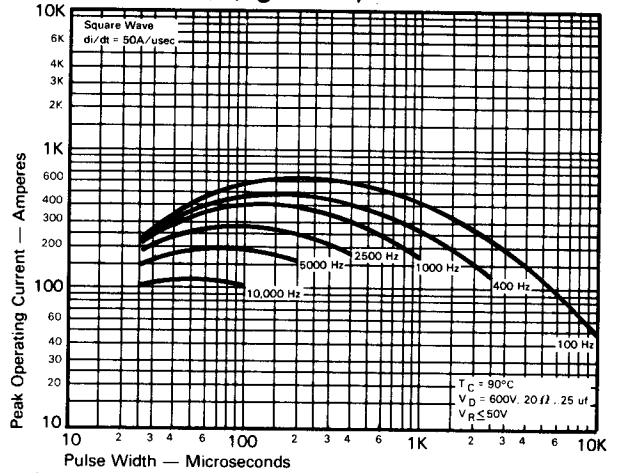

MAXIMUM ALLOWABLE PEAK ON-STATE CURRENT vs. PULSE WIDTH ($di/dt = 50A/us$)

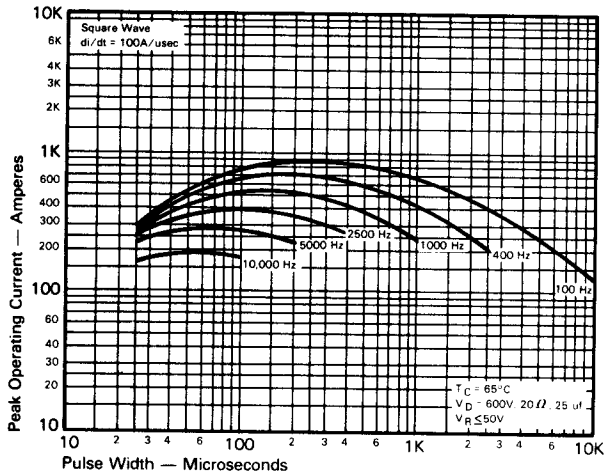

MAXIMUM ALLOWABLE PEAK ON-STATE CURRENT vs. PULSE WIDTH ($di/dt = 100A/us$)

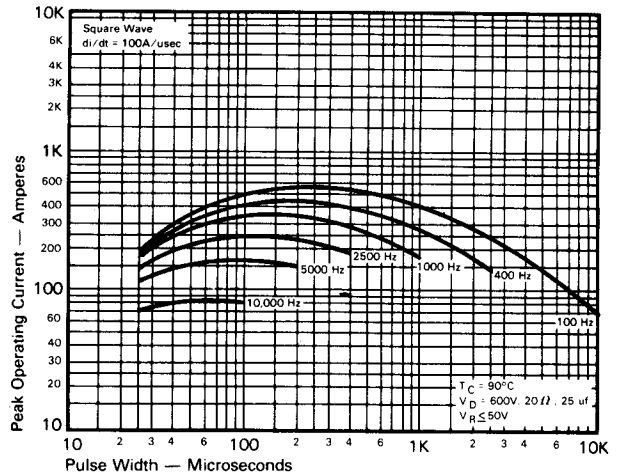

MAXIMUM ALLOWABLE PEAK ON-STATE CURRENT vs. PULSE WIDTH ($di/dt = 100A/us$)

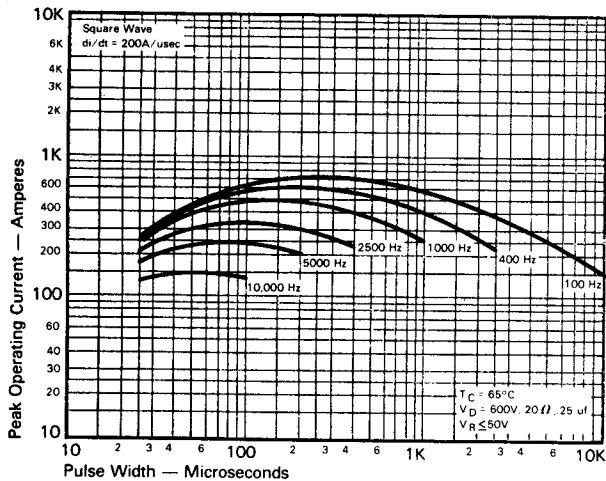

MAXIMUM ALLOWABLE PEAK ON-STATE CURRENT vs. PULSE WIDTH ($di/dt = 200A/us$)

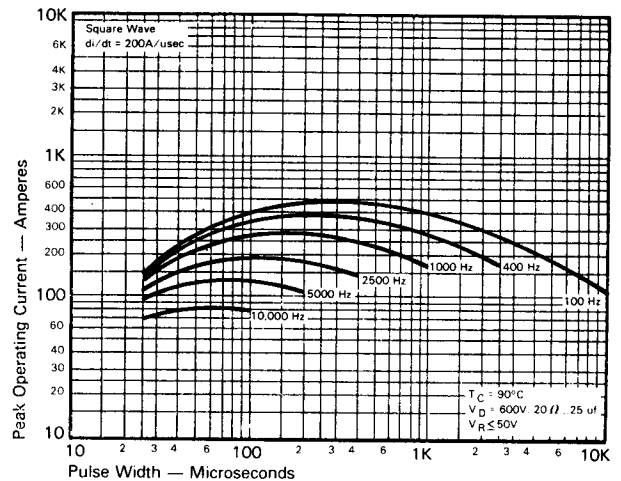

MAXIMUM ALLOWABLE PEAK ON-STATE CURRENT vs. PULSE WIDTH ($di/dt = 200A/us$)

FAST SWITCHING THYRISTORS

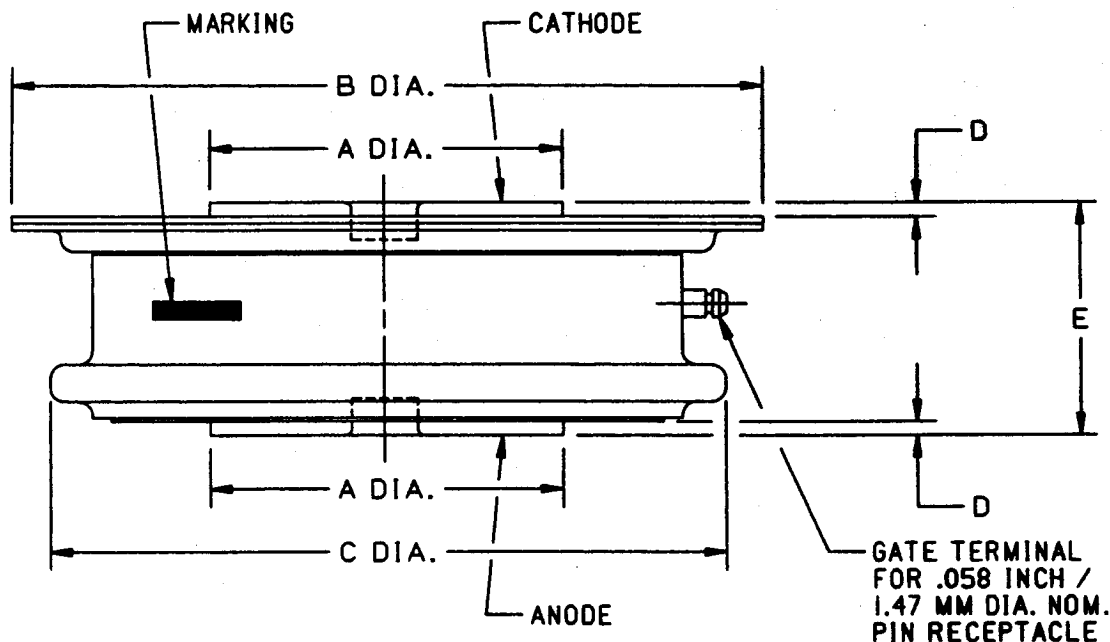
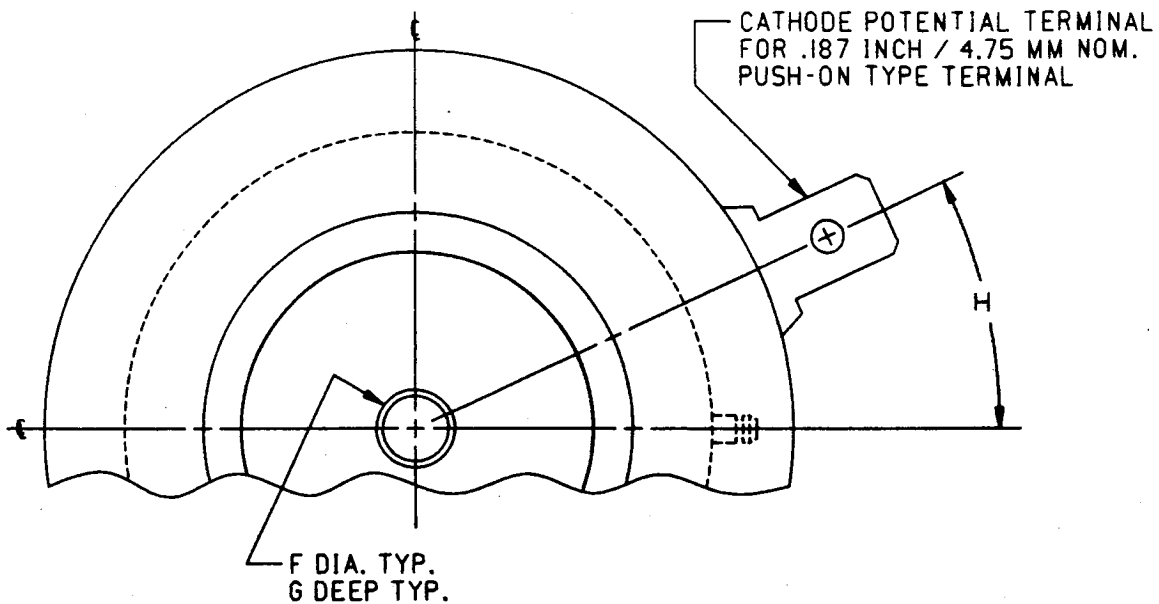

CASE NUMBER T62
NOMINAL DIMENSIONS

STRIKE DISTANCE = .21 INCH / 5.3 MM MIN.
CREEPAGE DISTANCE = .34 INCH / 8.6 MM MIN.

SYM.	A	B	C	D	E	F	G	H
INCHES	.75	1.63	1.44	.030	.500/.565	.140	.080	25°
MM	19.0	41.4	36.6	0.76	12.70/14.35	3.56	2.03	25°

ALL DIMENSIONS ARE REFERENCE