

## Phase Control Thyristors (Stud Version), 330 A



TO-118 (TO- 209AE)

PRIMARY CHARACTERISTICS	
$I_{T(AV)}$	330 A
$V_{DRM}/V_{RRM}$	400 V, 800 V, 1200 V, 1400 V, 1600 V, 2000 V
$V_{TM}$	1.52 V
$I_{GT}$	200 mA
$T_J$	-40 °C to +125 °C
Package	TO-118 (TO-209AE)
Circuit configuration	Single SCR

### FEATURES

- Center amplifying gate
- International standard case TO-118 (TO-209AE)
- Hermetic metal case with ceramic insulator
- Compression bonded encapsulation for heavy duty operations such as severe thermal cycling
- Designed and qualified for industrial level
- Material categorization: for definitions of compliance please see [www.vishay.com/doc?99912](http://www.vishay.com/doc?99912)

**RoHS  
COMPLIANT**

### TYPICAL APPLICATIONS

- DC motor controls
- Controlled DC power supplies
- AC controllers

MAJOR RATINGS AND CHARACTERISTICS			
PARAMETER	TEST CONDITIONS	VALUES	UNITS
$I_{T(AV)}$		330	A
	$T_C$	75	°C
$I_{T(RMS)}$		520	A
$I_{TSM}$	50 Hz	9000	
	60 Hz	9420	
$I^2t$	50 Hz	405	kA <sup>2</sup> s
	60 Hz	370	
$V_{DRM}/V_{RRM}$		400 to 2000	V
$t_q$	Typical	100	µs
$T_J$		-40 to +125	°C

### ELECTRICAL SPECIFICATIONS

VOLTAGE RATINGS				
TYPE NUMBER	VOLTAGE CODE	$V_{DRM}/V_{RRM}$ , MAXIMUM REPETITIVE PEAK AND OFF-STATE VOLTAGE V	$V_{RSM}$ , MAXIMUM NON-REPETITIVE PEAK VOLTAGE V	$I_{DRM}/I_{RRM}$ MAXIMUM AT $T_J = T_J$ MAXIMUM mA
VS-ST330S	04	400	500	50
	08	800	900	
	12	1200	1300	
	14	1400	1500	
	16	1600	1700	
	20	2000	2100	



<b>ABSOLUTE MAXIMUM RATINGS</b>					
PARAMETER	SYMBOL	TEST CONDITIONS		VALUES	UNITS
Maximum average on-state current at case temperature	$I_{T(AV)}$	180° conduction, half sine wave		330	A
				75	°C
Maximum RMS on-state current	$I_{T(RMS)}$	DC at 75 °C case temperature		520	
Maximum peak, one-cycle non-repetitive surge current	$I_{TSM}$	t = 10 ms	No voltage reapplied	9000	A
		t = 8.3 ms		9420	
		t = 10 ms	100 % $V_{RRM}$ reapplied	7570	
		t = 8.3 ms		7920	
Maximum $I^2t$ for fusing	$I^2t$	t = 10 ms	No voltage reapplied	405	kA <sup>2</sup> s
		t = 8.3 ms		370	
		t = 10 ms	100 % $V_{RRM}$ reapplied	287	
		t = 8.3 ms		262	
Maximum $I^2\sqrt{t}$ for fusing	$I^2\sqrt{t}$	t = 0.1 to 10 ms, no voltage reapplied		4050	kA <sup>2</sup> √s
Low level value of threshold voltage	$V_{T(TO)1}$	(16.7 % $\times \pi \times I_{T(AV)} < I < \pi \times I_{T(AV)}$ , $T_J = T_J$ maximum)		0.834	V
High level value of threshold voltage	$V_{T(TO)2}$	(I $> \pi \times I_{T(AV)}$ , $T_J = T_J$ maximum)		0.898	
Low level value of on-state slope resistance	$r_{t1}$	(16.7 % $\times \pi \times I_{T(AV)} < I < \pi \times I_{T(AV)}$ , $T_J = T_J$ maximum)		0.687	mΩ
High level value of on-state slope resistance	$r_{t2}$	(I $> \pi \times I_{T(AV)}$ , $T_J = T_J$ maximum)		0.636	
Maximum on-state voltage	$V_{TM}$	$I_{pk} = 1000$ A, $T_J = T_J$ maximum, $t_p = 10$ ms sine pulse		1.52	V
Maximum holding current	$I_H$	$T_J = 25$ °C, anode supply 12 V resistive load		600	mA
Typical latching current	$I_L$			1000	

<b>SWITCHING</b>					
PARAMETER	SYMBOL	TEST CONDITIONS		VALUES	UNITS
Maximum non-repetitive rate of rise of turned-on current	di/dt	Gate drive 20 V, 20 Ω, $t_r \leq 1$ μs $T_J = T_J$ maximum, anode voltage $\leq 80$ % $V_{DRM}$		1000	A/μs
Typical delay time	$t_d$	Gate current A, $dI_g/dt = 1$ A/μs $V_d = 0.67$ % $V_{DRM}$ , $T_J = 25$ °C		1.0	μs
Typical turn-off time	$t_q$	$I_{TM} = 550$ A, $T_J = T_J$ maximum, di/dt = 40 A/μs, $V_R = 50$ V, dV/dt = 20 V/μs, gate 0 V 100 Ω, $t_p = 500$ μs		100	

<b>BLOCKING</b>					
PARAMETER	SYMBOL	TEST CONDITIONS		VALUES	UNITS
Maximum critical rate of rise of off-state voltage	dV/dt	$T_J = T_J$ maximum linear to 80 % rated $V_{DRM}$		500	V/μs
Maximum peak reverse and off-state leakage current	$I_{RRM}$ , $I_{DRM}$	$T_J = T_J$ maximum, rated $V_{DRM}/V_{RRM}$ applied		50	mA



<b>TRIGGERING</b>						
PARAMETER	SYMBOL	TEST CONDITIONS		VALUES		UNITS
				TYP.	MAX.	
Maximum peak gate power	$P_{GM}$	$T_J = T_J$ maximum, $t_p \leq 5$ ms		10.0		W
Maximum average gate power	$P_{G(AV)}$	$T_J = T_J$ maximum, $f = 50$ Hz, $d\% = 50$		2.0		
Maximum peak positive gate current	$I_{GM}$	$T_J = T_J$ maximum, $t_p \leq 5$ ms		3.0		A
Maximum peak positive gate voltage	$+V_{GM}$	$T_J = T_J$ maximum, $t_p \leq 5$ ms		20		V
Maximum peak negative gate voltage	$-V_{GM}$			5.0		
DC gate current required to trigger	$I_{GT}$	$T_J = -40$ °C	Maximum required gate trigger/ current/voltage are the lowest value which will trigger all units 12 V anode to cathode applied	200	-	mA
		$T_J = 25$ °C		100	200	
		$T_J = 125$ °C		50	-	
DC gate voltage required to trigger	$V_{GT}$	$T_J = -40$ °C		2.5	-	V
		$T_J = 25$ °C		1.8	3	
		$T_J = 125$ °C		1.1	-	
DC gate current not to trigger	$I_{GD}$	$T_J = T_J$ maximum	Maximum gate current/voltage not to trigger is the maximum value which will not trigger any unit with rated $V_{DRM}$ anode to cathode applied	10		mA
DC gate voltage not to trigger	$V_{GD}$			0.25		V

<b>THERMAL AND MECHANICAL SPECIFICATIONS</b>				
PARAMETER	SYMBOL	TEST CONDITIONS	VALUES	UNITS
Maximum operating junction temperature range	$T_J$		-40 to +125	°C
Maximum storage temperature range	$T_{Stg}$		-40 to +150	
Maximum thermal resistance, junction to case	$R_{thJC}$	DC operation	0.10	K/W
Maximum thermal resistance, case to heatsink	$R_{thC-hs}$	Mounting surface, smooth, flat and greased	0.03	
Mounting torque, $\pm 10$ %		Non-lubricated threads	48.5 (425)	N · m (lbf · in)
Approximate weight			535	g
Case style		See dimension - link at the end of datasheet	TO-118 (TO-209AE)	

<b><math>\Delta R_{thJC}</math> CONDUCTION</b>				
CONDUCTION ANGLE	SINUSOIDAL CONDUCTION	RECTANGULAR CONDUCTION	TEST CONDITIONS	UNITS
180°	0.011	0.008	$T_J = T_J$ maximum	K/W
120°	0.013	0.014		
90°	0.017	0.018		
60°	0.025	0.026		
30°	0.041	0.042		

**Note**

- The table above shows the increment of thermal resistance  $R_{thJC}$  when devices operate at different conduction angles than DC

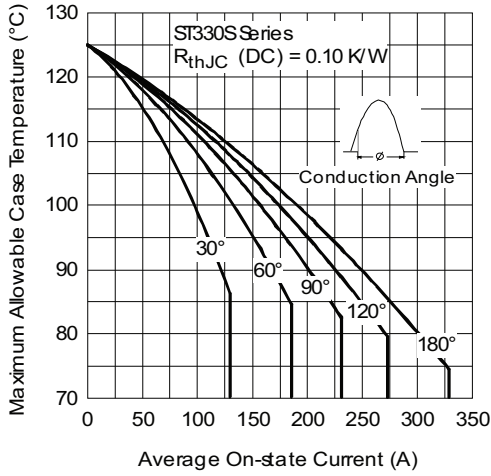

Fig. 1 - Current Ratings Characteristics

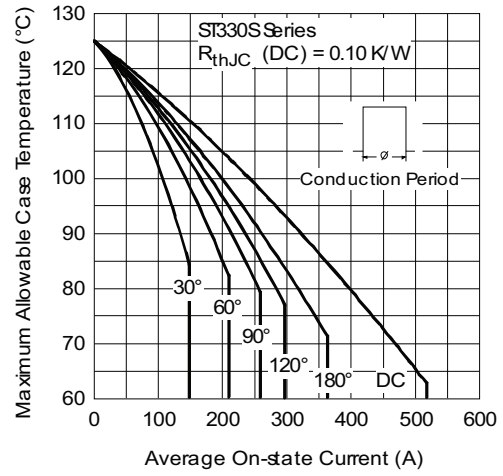

Fig. 2 - Current Ratings Characteristics

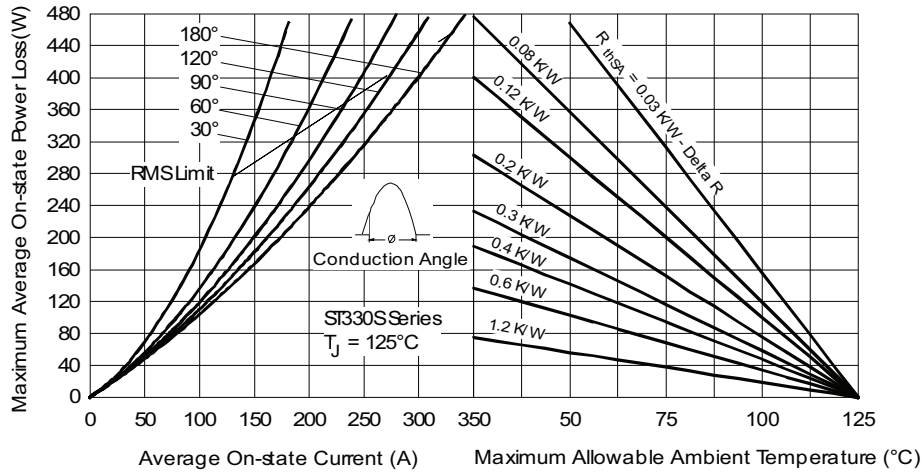

Fig. 3 - On-State Power Loss Characteristics

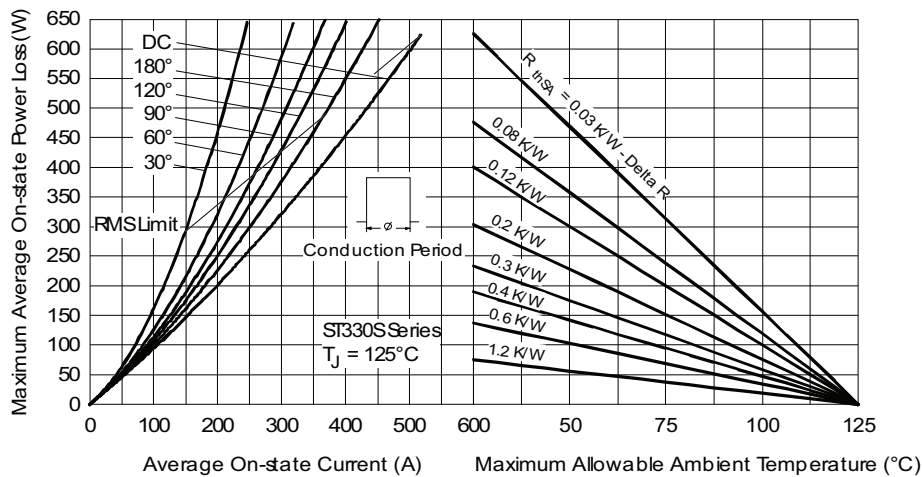

Fig. 4 - On-State Power Loss Characteristics

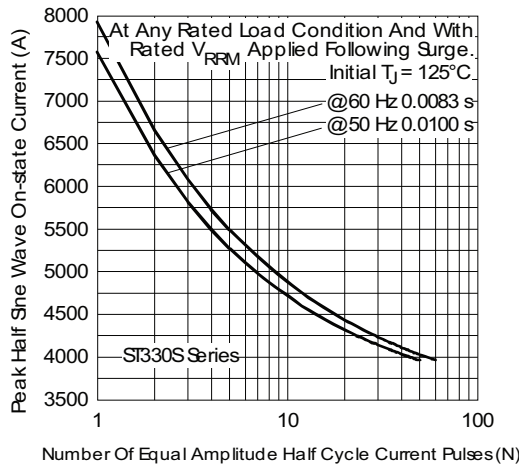

Fig. 5 - Maximum Non-Repetitive Surge Current

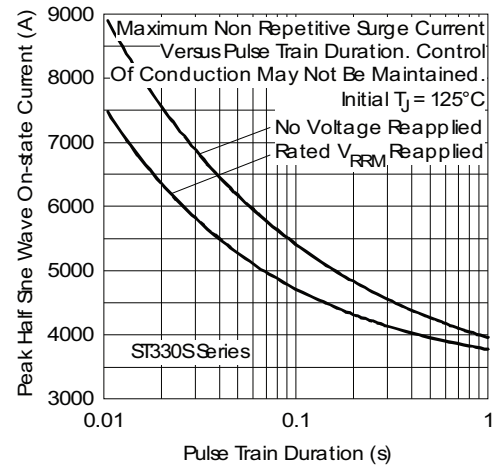

Fig. 6 - Maximum Non-Repetitive Surge Current

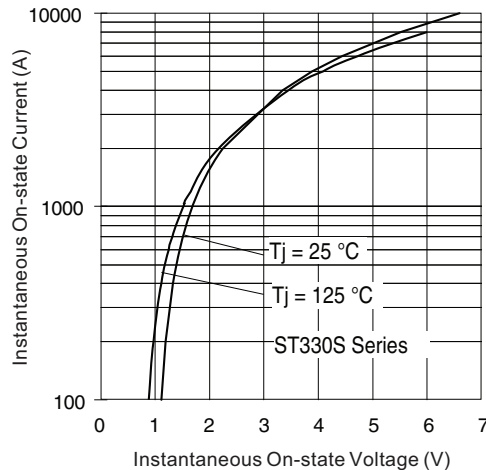

Fig. 7 - On-State Voltage Drop Characteristics

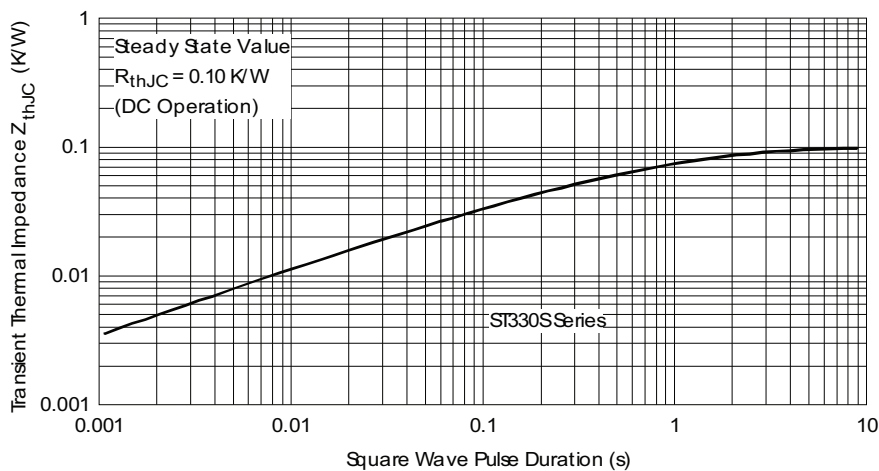

Fig. 8 - Thermal Impedance  $Z_{thJC}$  Characteristics

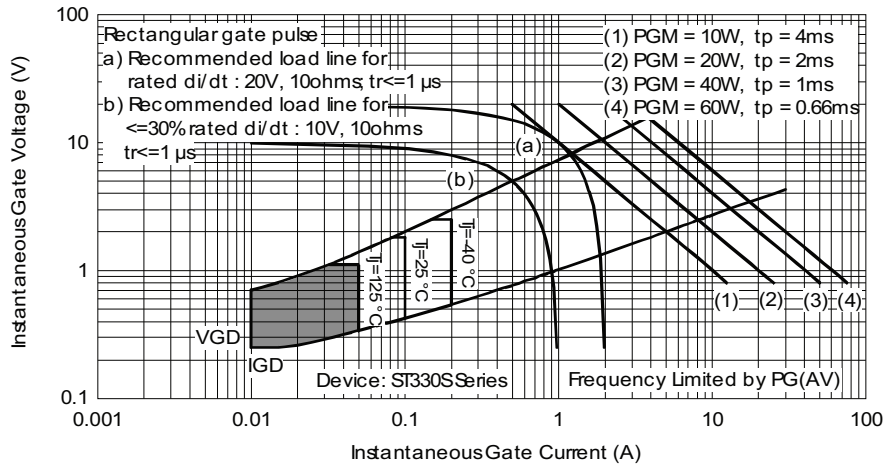

Fig. 9 - Gate Characteristics

**ORDERING INFORMATION TABLE**

Device code	<b>VS-</b>	<b>ST</b>	<b>33</b>	<b>0</b>	<b>S</b>	<b>16</b>	<b>P</b>	<b>0</b>	<b>PbF</b>
	1	2	3	4	5	6	7	8	9

- 1** - Vishay Semiconductors product
- 2** - Thyristor
- 3** - Essential part number
- 4** - 0 = converter grade
- 5** - S = compression bonding stud
- 6** - Voltage code x 100 =  $V_{RRM}$  (see Voltage Ratings table)
- 7** - P = stud base 3/4"-16UNF-2A threads  
M = stud base metric threads (M24 x 1.5)
- 8** - 0 = eyelet terminals (gate and auxiliary cathode leads)  
1 = fast-on terminals (gate and auxiliary cathode leads)
- 9** - None = standard production  
- PbF = lead (Pb)-free

LINKS TO RELATED DOCUMENTS	
Dimensions	<a href="http://www.vishay.com/doc?95080">www.vishay.com/doc?95080</a>

## TO-209AE (TO-118)

**DIMENSIONS** in millimeters (inches)

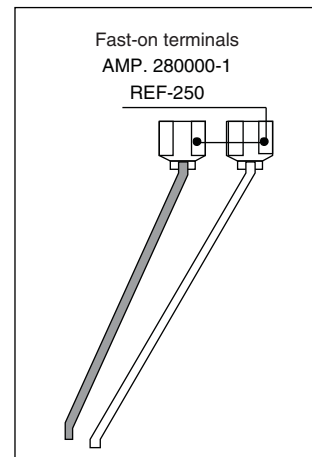
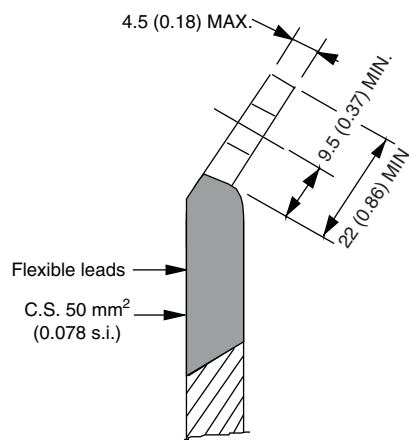
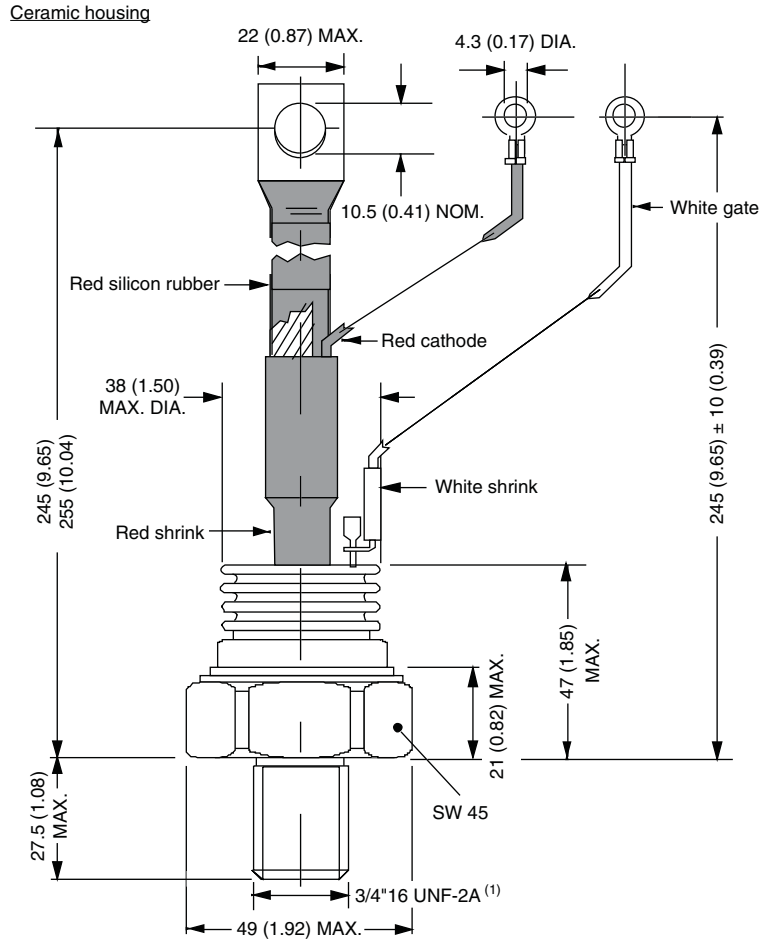

**Note**

<sup>(1)</sup> For metric device: M24 x 1.5 - length 21 (0.83) maximum



## Disclaimer

ALL PRODUCT, PRODUCT SPECIFICATIONS AND DATA ARE SUBJECT TO CHANGE WITHOUT NOTICE TO IMPROVE RELIABILITY, FUNCTION OR DESIGN OR OTHERWISE.

Vishay Intertechnology, Inc., its affiliates, agents, and employees, and all persons acting on its or their behalf (collectively, "Vishay"), disclaim any and all liability for any errors, inaccuracies or incompleteness contained in any datasheet or in any other disclosure relating to any product.

Vishay makes no warranty, representation or guarantee regarding the suitability of the products for any particular purpose or the continuing production of any product. To the maximum extent permitted by applicable law, Vishay disclaims (i) any and all liability arising out of the application or use of any product, (ii) any and all liability, including without limitation special, consequential or incidental damages, and (iii) any and all implied warranties, including warranties of fitness for particular purpose, non-infringement and merchantability.

Statements regarding the suitability of products for certain types of applications are based on Vishay's knowledge of typical requirements that are often placed on Vishay products in generic applications. Such statements are not binding statements about the suitability of products for a particular application. It is the customer's responsibility to validate that a particular product with the properties described in the product specification is suitable for use in a particular application. Parameters provided in datasheets and / or specifications may vary in different applications and performance may vary over time. All operating parameters, including typical parameters, must be validated for each customer application by the customer's technical experts. Product specifications do not expand or otherwise modify Vishay's terms and conditions of purchase, including but not limited to the warranty expressed therein.

Hyperlinks included in this datasheet may direct users to third-party websites. These links are provided as a convenience and for informational purposes only. Inclusion of these hyperlinks does not constitute an endorsement or an approval by Vishay of any of the products, services or opinions of the corporation, organization or individual associated with the third-party website. Vishay disclaims any and all liability and bears no responsibility for the accuracy, legality or content of the third-party website or for that of subsequent links.

Vishay products are not designed for use in life-saving or life-sustaining applications or any application in which the failure of the Vishay product could result in personal injury or death unless specifically qualified in writing by Vishay. Customers using or selling Vishay products not expressly indicated for use in such applications do so at their own risk. Please contact authorized Vishay personnel to obtain written terms and conditions regarding products designed for such applications.

No license, express or implied, by estoppel or otherwise, to any intellectual property rights is granted by this document or by any conduct of Vishay. Product names and markings noted herein may be trademarks of their respective owners.