

# MBD301G, MMBD301LT1G, MMBD301LT3G, SMMBD301LT3G



ON Semiconductor®

[www.onsemi.com](http://www.onsemi.com)

## Silicon Hot-Carrier Diodes

### Schottky Barrier Diodes

These devices are designed primarily for high-efficiency UHF and VHF detector applications. They are readily adaptable to many other fast switching RF and digital applications. They are supplied in an inexpensive plastic package for low-cost, high-volume consumer and industrial/commercial requirements. They are also available in a Surface Mount package.

#### Features

- Extremely Low Minority Carrier Lifetime – 15 ps (Typ)
- Very Low Capacitance – 1.5 pF (Max) @  $V_R = 15\text{ V}$
- Low Reverse Leakage –  $I_R = 13\text{ nAdc}$  (Typ) MBD301, MMBD301
- S Prefix for Automotive and Other Applications Requiring Unique Site and Control Change Requirements; AEC-Q101 Qualified and PPAP Capable
- These Devices are Pb-Free, Halogen Free/BFR Free and are RoHS Compliant

#### MAXIMUM RATINGS

| Rating   | Symbol    | Value          | Unit                 |
|--|-----------|----------------|----------------------|
| Reverse Voltage  | $V_R$     | 30             | V                    |
| Forward Current (DC)   | $I_F$     | 200 (Max)      | mA                   |
| Total Device Dissipation<br>@ $T_A = 25^\circ\text{C}$<br>MBD301G<br>MMBD301LT1G, MMBD301LT3G,<br>SMMBD301LT3G | $P_F$     | 280<br>200     | MW                   |
| Derate above $25^\circ\text{C}$<br>MBD301G<br>MMBD301LT1G, MMBD301LT3G,<br>SMMBD301LT3G                        |           | 2.8<br>2.0     | mW/ $^\circ\text{C}$ |
| Operating Junction<br>Temperature Range  | $T_J$     | -55 to<br>+125 | $^\circ\text{C}$     |
| Storage Temperature Range  | $T_{stg}$ | -55 to<br>+150 | $^\circ\text{C}$     |

Stresses exceeding those listed in the Maximum Ratings table may damage the device. If any of these limits are exceeded, device functionality should not be assumed, damage may occur and reliability may be affected.

## 30 VOLTS SILICON HOT-CARRIER DETECTOR AND SWITCHING DIODES



TO-92 2-Lead  
CASE 182  
STYLE 1

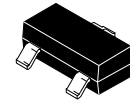

SOT-23 (TO-236)  
CASE 318  
STYLE 8

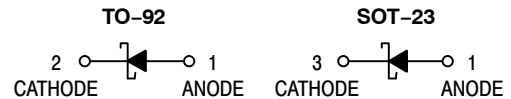

#### MARKING DIAGRAMS

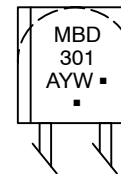

TO-92

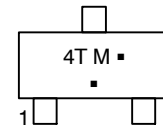

SOT-23

- A = Assembly Location
- Y = Year
- W = Work Week
- 4T = Device Code (SOT-23)
- M = Date Code\*
- = Pb-Free Package

(Note: Microdot may be in either location)

\*Date Code orientation and/or overbar may vary depending upon manufacturing location.

#### ORDERING INFORMATION

See detailed ordering and shipping information in the package dimensions section on page 2 of this data sheet.

## MBD301G, MMBD301LT1G, MMBD301LT3G, SMMBD301LT3G

### ELECTRICAL CHARACTERISTICS (T<sub>A</sub> = 25°C unless otherwise noted)

| Characteristic   | Symbol             | Min | Typ  | Max  | Unit |
|--|--------------------|-----|------|------|------|
| Reverse Breakdown Voltage<br>(I <sub>R</sub> = 10 μA)              | V <sub>(BR)R</sub> | 30  | –    | –    | V    |
| Total Capacitance<br>(V <sub>R</sub> = 15 V, f = 1.0 MHz) Figure 1 | C <sub>T</sub>     | –   | 0.9  | 1.5  | pF   |
| Reverse Leakage<br>(V <sub>R</sub> = 25 V) Figure 3                | I <sub>R</sub>     | –   | 13   | 200  | nAdc |
| Forward Voltage<br>(I <sub>F</sub> = 1.0 mAdc) Figure 4            | V <sub>F</sub>     | –   | 0.38 | 0.45 | Vdc  |
| Forward Voltage<br>(I <sub>F</sub> = 10 mAdc) Figure 4             | V <sub>F</sub>     | –   | 0.52 | 0.6  | Vdc  |

Product parametric performance is indicated in the Electrical Characteristics for the listed test conditions, unless otherwise noted. Product performance may not be indicated by the Electrical Characteristics if operated under different conditions.

### ORDERING INFORMATION

| Device       | Package             | Shipping <sup>†</sup> |
|--------------|---------------------|-----------------------|
| MBD301G      | TO-92<br>(Pb-Free)  | 5,000 Units / Bulk    |
| MMBD301LT1G  | SOT-23<br>(Pb-Free) | 3,000 / Tape & Reel   |
| MMBD301LT3G  | SOT-23<br>(Pb-Free) | 10,000 / Tape & Reel  |
| SMMBD301LT3G | SOT-23<br>(Pb-Free) | 10,000 / Tape & Reel  |

<sup>†</sup>For information on tape and reel specifications, including part orientation and tape sizes, please refer to our Tape and Reel Packaging Specifications Brochure, BRD8011/D.

TYPICAL ELECTRICAL CHARACTERISTICS

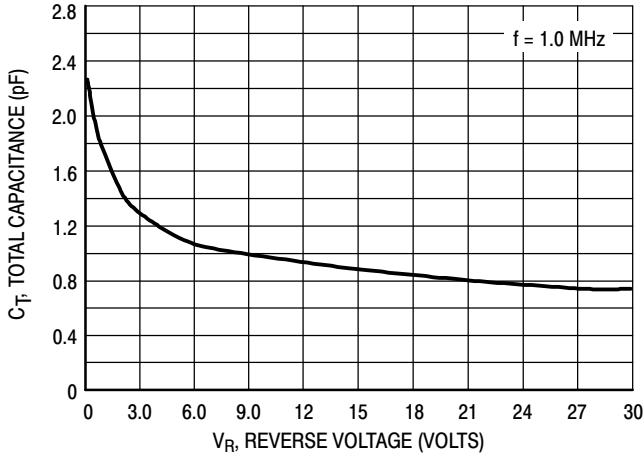

Figure 1. Total Capacitance

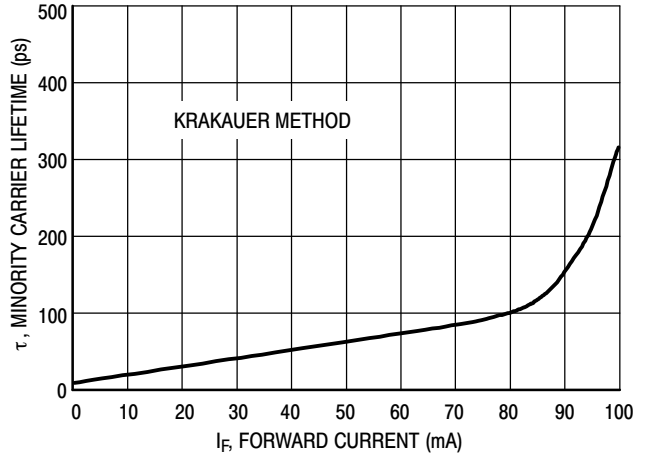

Figure 2. Minority Carrier Lifetime

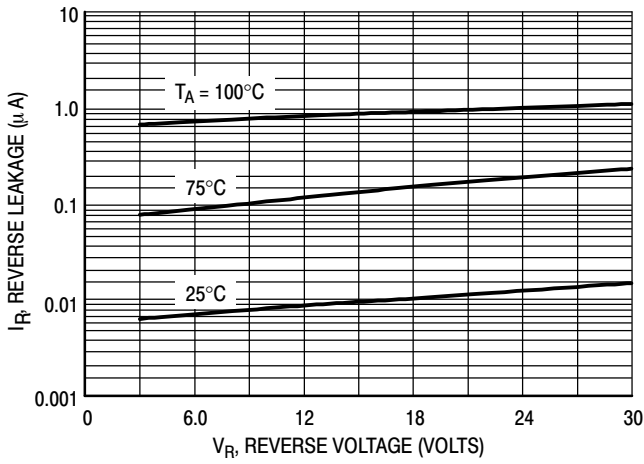

Figure 3. Reverse Leakage

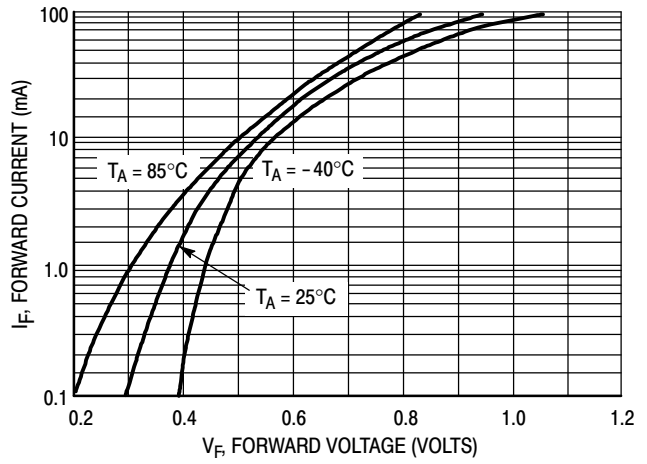

Figure 4. Forward Voltage

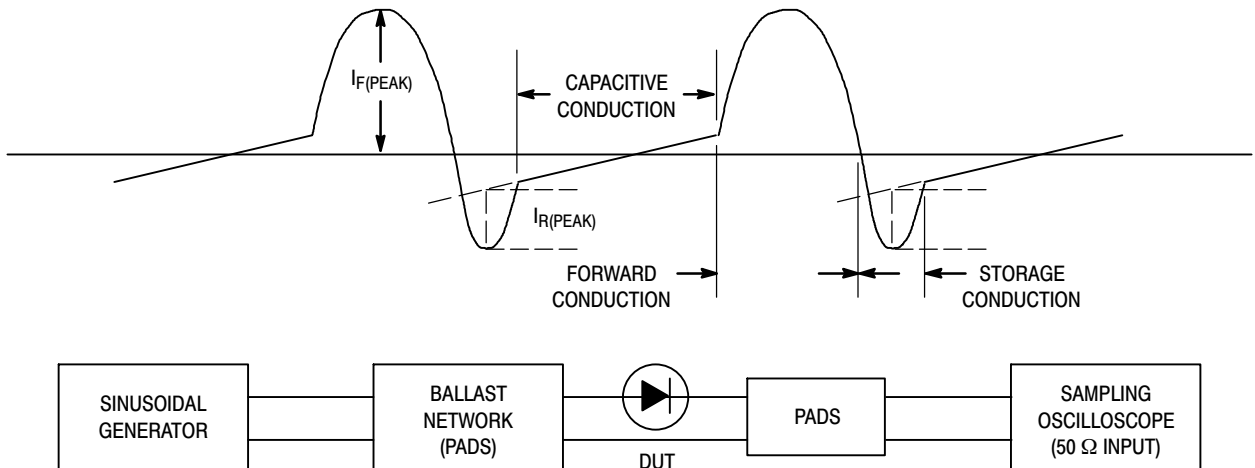

Figure 5. Krakauer Method of Measuring Lifetime

# MECHANICAL CASE OUTLINE

## PACKAGE DIMENSIONS

ON Semiconductor®



TO-92 (TO-226)  
CASE 182-06  
ISSUE L

DATE 04/18/1998

SCALE 1:1

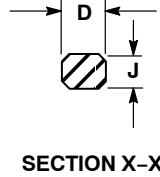
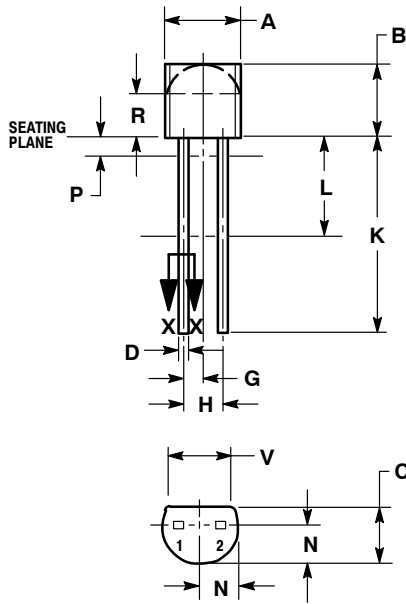

NOTES:

1. DIMENSIONING AND TOLERANCING PER ANSI Y14.5M, 1982.
2. CONTROLLING DIMENSION: INCH.
3. CONTOUR OF PACKAGE BEYOND ZONE R IS UNCONTROLLED.
4. LEAD DIMENSION IS UNCONTROLLED IN P AND BEYOND DIMENSION K MINIMUM.

| DIM | INCHES    |       | MILLIMETERS |       |
|-----|-----------|-------|-------------|-------|
|     | MIN       | MAX   | MIN         | MAX   |
| A   | 0.175     | 0.205 | 4.45        | 5.21  |
| B   | 0.170     | 0.210 | 4.32        | 5.33  |
| C   | 0.125     | 0.165 | 3.18        | 4.19  |
| D   | 0.016     | 0.021 | 0.407       | 0.533 |
| G   | 0.050 BSC |       | 1.27 BSC    |       |
| H   | 0.100 BSC |       | 2.54 BSC    |       |
| J   | 0.014     | 0.016 | 0.36        | 0.41  |
| K   | 0.500     | ---   | 12.70       | ---   |
| L   | 0.250     | ---   | 6.35        | ---   |
| N   | 0.080     | 0.105 | 2.03        | 2.66  |
| P   | ---       | 0.050 | ---         | 1.27  |
| R   | 0.115     | ---   | 2.93        | ---   |
| V   | 0.135     | ---   | 3.43        | ---   |

STYLE 1:

- PIN 1. ANODE
- 2. CATHODE

STYLE 2:

- PIN 1. CATHODE
- 2. ANODE

STYLE 3:

- PIN 1. MAIN TERMINAL 1
- 2. MAIN TERMINAL 2

STYLE 4:

CANCELLED

STYLE 5:

- PIN 1. INPUT
- 2. OUTPUT

|                         |                       |   |
|-------------------------|-----------------------|---|
| <b>DOCUMENT NUMBER:</b> | <b>98ASB42118B</b>    | Electronic versions are uncontrolled except when accessed directly from the Document Repository.<br>Printed versions are uncontrolled except when stamped "CONTROLLED COPY" in red. |
| <b>DESCRIPTION:</b>     | <b>TO-92 (TO-226)</b> | <b>PAGE 1 OF 1</b>  |

ON Semiconductor and are trademarks of Semiconductor Components Industries, LLC dba ON Semiconductor or its subsidiaries in the United States and/or other countries. ON Semiconductor reserves the right to make changes without further notice to any products herein. ON Semiconductor makes no warranty, representation or guarantee regarding the suitability of its products for any particular purpose, nor does ON Semiconductor assume any liability arising out of the application or use of any product or circuit, and specifically disclaims any and all liability, including without limitation special, consequential or incidental damages. ON Semiconductor does not convey any license under its patent rights nor the rights of others.

# MECHANICAL CASE OUTLINE PACKAGE DIMENSIONS

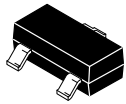

**SOT-23 (TO-236)**  
CASE 318  
ISSUE AT

DATE 01 MAR 2023

SCALE 4:1

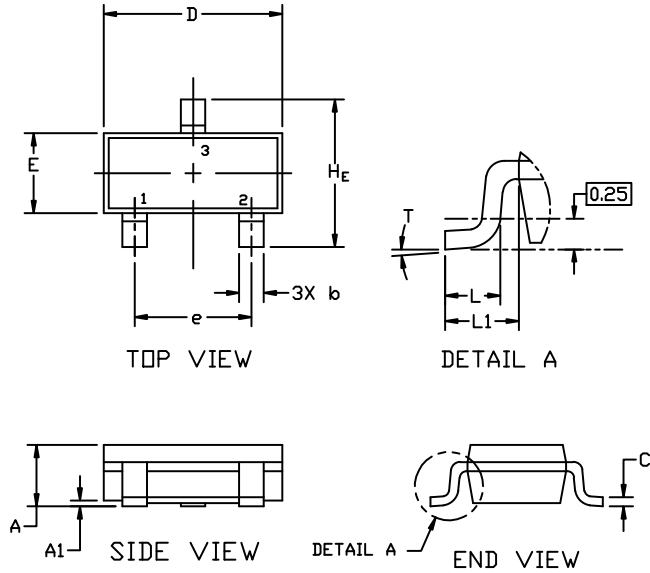

**NOTES:**

1. DIMENSIONING AND TOLERANCING PER ASME Y14.5M,1994.
2. CONTROLLING DIMENSION: MILLIMETERS
3. MAXIMUM LEAD THICKNESS INCLUDES LEAD FINISH. MINIMUM LEAD THICKNESS IS THE MINIMUM THICKNESS OF THE BASE MATERIAL.
4. DIMENSIONS D AND E DO NOT INCLUDE MOLD FLASH, PROTRUSIONS, OR GATE BURRS.

| DIM            | MILLIMETERS |      |      | INCHES |       |       |
|----------------|-------------|------|------|--------|-------|-------|
|                | MIN.        | NOM. | MAX. | MIN.   | NOM.  | MAX.  |
| A              | 0.89        | 1.00 | 1.11 | 0.035  | 0.039 | 0.044 |
| A1             | 0.01        | 0.06 | 0.10 | 0.000  | 0.002 | 0.004 |
| b              | 0.37        | 0.44 | 0.50 | 0.015  | 0.017 | 0.020 |
| c              | 0.08        | 0.14 | 0.20 | 0.003  | 0.006 | 0.008 |
| D              | 2.80        | 2.90 | 3.04 | 0.110  | 0.114 | 0.120 |
| E              | 1.20        | 1.30 | 1.40 | 0.047  | 0.051 | 0.055 |
| e              | 1.78        | 1.90 | 2.04 | 0.070  | 0.075 | 0.080 |
| L              | 0.30        | 0.43 | 0.55 | 0.012  | 0.017 | 0.022 |
| L1             | 0.35        | 0.54 | 0.69 | 0.014  | 0.021 | 0.027 |
| H <sub>E</sub> | 2.10        | 2.40 | 2.64 | 0.083  | 0.094 | 0.104 |
| T              | 0°          | ---  | 10°  | 0°     | ---   | 10°   |

**GENERIC MARKING DIAGRAM\***

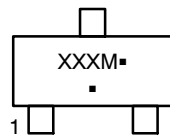

- XXX = Specific Device Code
- M = Date Code
- = Pb-Free Package

\*This information is generic. Please refer to device data sheet for actual part marking. Pb-Free indicator, "G" or microdot "▪", may or may not be present. Some products may not follow the Generic Marking.

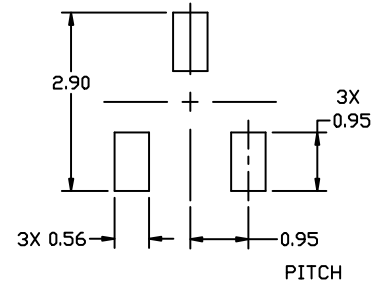

**RECOMMENDED MOUNTING FOOTPRINT**

\* For additional information on our Pb-Free strategy and soldering details, please download the ON Semiconductor Soldering and Mounting Techniques Reference Manual, SOLDERRM/D.

**STYLES ON PAGE 2**

|                         |                        |  |
|-------------------------|------------------------|--|
| <b>DOCUMENT NUMBER:</b> | <b>98ASB42226B</b>     | Electronic versions are uncontrolled except when accessed directly from the Document Repository. Printed versions are uncontrolled except when stamped "CONTROLLED COPY" in red. |
| <b>DESCRIPTION:</b>     | <b>SOT-23 (TO-236)</b> | <b>PAGE 1 OF 2</b>   |

onsemi and ONSEMI are trademarks of Semiconductor Components Industries, LLC dba onsemi or its subsidiaries in the United States and/or other countries. onsemi reserves the right to make changes without further notice to any products herein. onsemi makes no warranty, representation or guarantee regarding the suitability of its products for any particular purpose, nor does onsemi assume any liability arising out of the application or use of any product or circuit, and specifically disclaims any and all liability, including without limitation special, consequential or incidental damages. onsemi does not convey any license under its patent rights nor the rights of others.

**MECHANICAL CASE OUTLINE**  
**PACKAGE DIMENSIONS**



**SOT-23 (TO-236)**  
**CASE 318**  
**ISSUE AT**

DATE 01 MAR 2023

- |   |   |   |   |   |   |
|---|---|---|---|---|---|
| STYLE 1 THRU 5:<br>CANCELLED                            | STYLE 6:<br>PIN 1. BASE<br>2. EMITTER<br>3. COLLECTOR | STYLE 7:<br>PIN 1. EMITTER<br>2. BASE<br>3. COLLECTOR       | STYLE 8:<br>PIN 1. ANODE<br>2. NO CONNECTION<br>3. CATHODE  |   |   |
| STYLE 9:<br>PIN 1. ANODE<br>2. ANODE<br>3. CATHODE      | STYLE 10:<br>PIN 1. DRAIN<br>2. SOURCE<br>3. GATE     | STYLE 11:<br>PIN 1. ANODE<br>2. CATHODE<br>3. CATHODE-ANODE | STYLE 12:<br>PIN 1. CATHODE<br>2. CATHODE<br>3. ANODE       | STYLE 13:<br>PIN 1. SOURCE<br>2. DRAIN<br>3. GATE           | STYLE 14:<br>PIN 1. CATHODE<br>2. GATE<br>3. ANODE          |
| STYLE 15:<br>PIN 1. GATE<br>2. CATHODE<br>3. ANODE      | STYLE 16:<br>PIN 1. ANODE<br>2. CATHODE<br>3. CATHODE | STYLE 17:<br>PIN 1. NO CONNECTION<br>2. ANODE<br>3. CATHODE | STYLE 18:<br>PIN 1. NO CONNECTION<br>2. CATHODE<br>3. ANODE | STYLE 19:<br>PIN 1. CATHODE<br>2. ANODE<br>3. CATHODE-ANODE | STYLE 20:<br>PIN 1. CATHODE<br>2. ANODE<br>3. GATE          |
| STYLE 21:<br>PIN 1. GATE<br>2. SOURCE<br>3. DRAIN       | STYLE 22:<br>PIN 1. RETURN<br>2. OUTPUT<br>3. INPUT   | STYLE 23:<br>PIN 1. ANODE<br>2. ANODE<br>3. CATHODE         | STYLE 24:<br>PIN 1. GATE<br>2. DRAIN<br>3. SOURCE           | STYLE 25:<br>PIN 1. ANODE<br>2. CATHODE<br>3. GATE          | STYLE 26:<br>PIN 1. CATHODE<br>2. ANODE<br>3. NO CONNECTION |
| STYLE 27:<br>PIN 1. CATHODE<br>2. CATHODE<br>3. CATHODE | STYLE 28:<br>PIN 1. ANODE<br>2. ANODE<br>3. ANODE     |   |   |   |   |

|                         |                        |   |
|-------------------------|------------------------|---|
| <b>DOCUMENT NUMBER:</b> | <b>98ASB42226B</b>     | Electronic versions are uncontrolled except when accessed directly from the Document Repository.<br>Printed versions are uncontrolled except when stamped "CONTROLLED COPY" in red. |
| <b>DESCRIPTION:</b>     | <b>SOT-23 (TO-236)</b> | <b>PAGE 2 OF 2</b>  |

**onsemi** and **ONSEMI** are trademarks of Semiconductor Components Industries, LLC dba **onsemi** or its subsidiaries in the United States and/or other countries. **onsemi** reserves the right to make changes without further notice to any products herein. **onsemi** makes no warranty, representation or guarantee regarding the suitability of its products for any particular purpose, nor does **onsemi** assume any liability arising out of the application or use of any product or circuit, and specifically disclaims any and all liability, including without limitation special, consequential or incidental damages. **onsemi** does not convey any license under its patent rights nor the rights of others.

**onsemi**, **Onsemi**, and other names, marks, and brands are registered and/or common law trademarks of Semiconductor Components Industries, LLC dba "**onsemi**" or its affiliates and/or subsidiaries in the United States and/or other countries. **onsemi** owns the rights to a number of patents, trademarks, copyrights, trade secrets, and other intellectual property. A listing of **onsemi**'s product/patent coverage may be accessed at [www.onsemi.com/site/pdf/Patent-Marking.pdf](http://www.onsemi.com/site/pdf/Patent-Marking.pdf). **onsemi** reserves the right to make changes at any time to any products or information herein, without notice. The information herein is provided "as-is" and **onsemi** makes no warranty, representation or guarantee regarding the accuracy of the information, product features, availability, functionality, or suitability of its products for any particular purpose, nor does **onsemi** assume any liability arising out of the application or use of any product or circuit, and specifically disclaims any and all liability, including without limitation special, consequential or incidental damages. Buyer is responsible for its products and applications using **onsemi** products, including compliance with all laws, regulations and safety requirements or standards, regardless of any support or applications information provided by **onsemi**. "Typical" parameters which may be provided in **onsemi** data sheets and/or specifications can and do vary in different applications and actual performance may vary over time. All operating parameters, including "Typicals" must be validated for each customer application by customer's technical experts. **onsemi** does not convey any license under any of its intellectual property rights nor the rights of others. **onsemi** products are not designed, intended, or authorized for use as a critical component in life support systems or any FDA Class 3 medical devices or medical devices with a same or similar classification in a foreign jurisdiction or any devices intended for implantation in the human body. Should Buyer purchase or use **onsemi** products for any such unintended or unauthorized application, Buyer shall indemnify and hold **onsemi** and its officers, employees, subsidiaries, affiliates, and distributors harmless against all claims, costs, damages, and expenses, and reasonable attorney fees arising out of, directly or indirectly, any claim of personal injury or death associated with such unintended or unauthorized use, even if such claim alleges that **onsemi** was negligent regarding the design or manufacture of the part. **onsemi** is an Equal Opportunity/Affirmative Action Employer. This literature is subject to all applicable copyright laws and is not for resale in any manner.

---

## ADDITIONAL INFORMATION

### TECHNICAL PUBLICATIONS:

Technical Library: [www.onsemi.com/design/resources/technical-documentation](http://www.onsemi.com/design/resources/technical-documentation)  
onsemi Website: [www.onsemi.com](http://www.onsemi.com)

### ONLINE SUPPORT: [www.onsemi.com/support](http://www.onsemi.com/support)

For additional information, please contact your local Sales Representative at [www.onsemi.com/support/sales](http://www.onsemi.com/support/sales)