

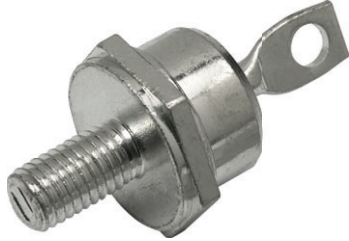

Fast Recovery Diodes (Stud Version), 40 A, 70 A, 85 A



DO-5 (DO-203AB)

FEATURES

- Short reverse recovery time
- Low stored charge
- Wide current range
- Excellent surge capabilities
- Stud cathode and stud anode versions
- Types up to 100 V_{RRM}
- Material categorization: for definitions of compliance please see www.vishay.com/doc?99912



RoHS
COMPLIANT

TYPICAL APPLICATIONS

- DC power supplies
- Inverters
- Converters
- Choppers
- Ultrasonic systems
- Freewheeling diodes

| PRIMARY CHARACTERISTICS | |
|-------------------------|------------------|
| I _{F(AV)} | 40 A, 70 A, 85 A |
| Package | DO-5 (DO-203AB) |
| Circuit Configuration | Single |

| MAJOR RATINGS AND CHARACTERISTICS | | | | | |
|-----------------------------------|------------------------|------------------------------------|------------------------------------|------------------------------------|-------------------|
| PARAMETER | TEST CONDITIONS | 40HFL | 70HFL | 85HFL | UNITS |
| I _{F(AV)} | | 40 | 70 | 85 | A |
| | T _C maximum | 85 | 85 | 85 | °C |
| I _{FSM} | 50 Hz | 400 | 700 | 1100 | A |
| | 60 Hz | 420 | 730 | 1151 | |
| I ² t | 50 Hz | 800 | 2450 | 6050 | A ² s |
| | 60 Hz | 730 | 2240 | 5523 | |
| I ² √t | | 11 300 | 34 650 | 85 560 | I ² √s |
| V _{RRM} | Range | 100 to 1000 | 100 to 1000 | 100 to 1000 | V |
| t _{rr} | | See Recovery Characteristics table | See Recovery Characteristics table | See Recovery Characteristics table | ns |
| T _J | Range | -40 to +125 | -40 to +125 | -40 to +125 | °C |



ELECTRICAL SPECIFICATIONS

| VOLTAGE RATINGS | | | | |
|------------------------------|---|---|--|-------------------------|
| TYPE NUMBER ⁽¹⁾ | V _{RRM} , MAXIMUM PEAK REPETITIVE REVERSE VOLTAGE T _J = - 40 °C TO 125 °C V | V _{RSM} , MAXIMUM PEAK NON-REPETITIVE REVERSE VOLTAGE T _J = 25 °C TO 125 °C V | I _{FM} , MAXIMUM PEAK REVERSE CURRENT AT RATED V _{RRM} mA | |
| | | | T _J = 25 °C | T _J = 125 °C |
| VS-40HFL10S02, VS-40HFL10S05 | 100 | 150 | 0.1 | 10 |
| VS-40HFL20S02, VS-40HFL20S05 | 200 | 300 | | |
| VS-40HFL40S02, VS-40HFL40S05 | 400 | 500 | | |
| VS-40HFL60S02, VS-40HFL60S05 | 600 | 700 | | |
| VS-40HFL80S05 | 800 | 900 | | |
| VS-40HFL100S05 | 1000 | 1100 | | |
| VS-70HFL10S02, VS-70HFL10S05 | 100 | 150 | 0.1 | 15 |
| VS-70HFL20S02, VS-70HFL20S05 | 200 | 300 | | |
| VS-70HFL40S02, VS-70HFL40S05 | 400 | 500 | | |
| VS-70HFL60S02, VS-70HFL60S05 | 600 | 700 | | |
| VS-70HFL80S05 | 800 | 900 | | |
| VS-70HFL100S05 | 1000 | 1100 | | |
| VS-85HFL10S02, VS-85HFL10S05 | 100 | 150 | 0.1 | 20 |
| VS-85HFL20S02, VS-85HFL20S05 | 200 | 300 | | |
| VS-85HFL40S02, VS-85HFL40S05 | 400 | 500 | | |
| VS-85HFL60S02, VS-85HFL60S05 | 600 | 700 | | |
| VS-85HFL80S05 | 800 | 900 | | |
| VS-85HFL100S05 | 1000 | 1100 | | |

Note

⁽¹⁾ Types listed are cathode case, for anode case add "R" to code, i.e. 40HFLR20S02, 85HFLR100S05 etc.

| FORWARD CONDUCTION | | | | | | | |
|---|---------------------|--|---|--------|--------|-------------------|------------------|
| PARAMETER | SYMBOL | TEST CONDITIONS | 40HFL | 70HFL | 85HFL | UNITS | |
| Maximum average forward current at maximum case temperature | I _{F(AV)} | 180° conduction, half sine wave | 40 | 70 | 85 | A | |
| | | | 75 | | | °C | |
| Maximum RMS forward current | I _{F(RMS)} | | 63 | 110 | 134 | A | |
| Maximum peak repetitive forward current | I _{FRM} | Sinusoidal half wave, 30° conduction | 220 | 380 | 470 | A | |
| Maximum peak, one-cycle non-repetitive forward current | I _{FSM} | t = 10 ms | Sinusoidal half wave, 100 % V _{RRM} reapplied, initial T _J = T _J maximum | 400 | 700 | 1100 | A |
| | | t = 8.3 ms | | 420 | 730 | 1151 | |
| | | t = 10 ms | Sinusoidal half wave, no voltage reapplied, initial T _J = T _J maximum | 475 | 830 | 1308 | |
| | | t = 8.3 ms | | 500 | 870 | 1369 | |
| Maximum I ² t for fusing | I ² t | t = 10 ms | 100 % V _{RRM} reapplied, initial T _J = T _J maximum | 800 | 2450 | 6050 | A ² s |
| | | t = 8.3 ms | | 730 | 2240 | 5523 | |
| | | t = 10 ms | No voltage reapplied, initial T _J = T _J maximum | 1130 | 3460 | 8556 | |
| | | t = 8.3 ms | | 1030 | 3160 | 7810 | |
| Maximum I ² √t for fusing ⁽¹⁾ | I ² √t | t = 0.1 ms to 10 ms, no voltage reapplied | 11 300 | 34 650 | 85 560 | A ² √s | |
| Maximum value of threshold voltage | V _{F(TO)} | T _J = 125 °C | 1.081 | 1.085 | 1.128 | V | |
| Maximum value of forward slope resistance | r _F | | 6.33 | 3.40 | 2.11 | mΩ | |
| Maximum forward voltage drop | V _{FM} | T _J = 25 °C, I _{FM} = π x I _{F(AV)} | 1.95 | 1.85 | 1.75 | V | |

Note

⁽¹⁾ I²t for time t_x = I²√t x √t_x

| RECOVERY CHARACTERISTICS | | | | | | | | | |
|----------------------------------|----------|---|----------|------|----------|------|----------|------|-------|
| PARAMETER | SYMBOL | TEST CONDITIONS | 40HFL... | | 70HFL... | | 85HFL... | | UNITS |
| | | | S02 | S05 | S02 | S05 | S02 | S05 | |
| Typical reverse recovery time | t_{rr} | $T_J = 25\text{ }^\circ\text{C}$, $I_F = 1\text{ A}$ to $V_R = 30\text{ V}$, $di_F/dt = 100\text{ A}/\mu\text{s}$ | 70 | 180 | 60 | 150 | 50 | 120 | ns |
| | | $T_J = 25\text{ }^\circ\text{C}$, $-di_F/dt = 25\text{ A}/\mu\text{s}$, $I_{FM} = \pi \times \text{rated } I_{F(AV)}$ | 200 | 500 | 200 | 500 | 200 | 500 | |
| Typical reverse recovered charge | Q_{rr} | $T_J = 25\text{ }^\circ\text{C}$, $I_F = 1\text{ A}$ to $V_R = 30\text{ V}$, $di_F/dt = 100\text{ A}/\mu\text{s}$ | 160 | 750 | 90 | 500 | 70 | 340 | nC |
| | | $T_J = 25\text{ }^\circ\text{C}$, $-di_F/dt = 25\text{ A}/\mu\text{s}$, $I_{FM} = \pi \times \text{rated } I_{F(AV)}$ | 240 | 1300 | 240 | 1300 | 240 | 1300 | |

| THERMAL AND MECHANICAL SPECIFICATIONS | | | | | | |
|---|------------|---|-----------------|-------|-------|---------------------|
| PARAMETER | SYMBOL | TEST CONDITIONS | 40HFL | 70HFL | 85HFL | UNITS |
| Junction operating temperature range | T_J | | -40 to 125 | | | °C |
| Storage temperature range | T_{Stg} | | -40 to 150 | | | |
| Maximum thermal resistance, junction to case | R_{thJC} | DC operation | 0.60 | 0.36 | 0.30 | K/W |
| Maximum thermal resistance, case to heatsink | R_{thCS} | Mounting surface, smooth, flat and greased | 0.25 | | | |
| Maximum allowable mounting torque (+ 0 %, - 10 %) | | Not lubricated thread, tightening on nut ⁽¹⁾ | 3.4 (30) | | | N · m (lbf · in) |
| | | Lubricated thread, tightening on nut ⁽¹⁾ | 2.3 (20) | | | |
| | | Not lubricated thread, tightening on hexagon ⁽²⁾ | 4.2 (37) | | | |
| | | Lubricated thread, tightening on hexagon ⁽²⁾ | 3.2 (28) | | | |
| Approximate weight | | | 25 | | | |
| | | | 0.88 | | | |
| Case style | | JEDEC® | DO-5 (DO-203AB) | | | |

Notes

- (1) Recommended for pass-through holes
 (2) Recommended for holed threaded heatsinks

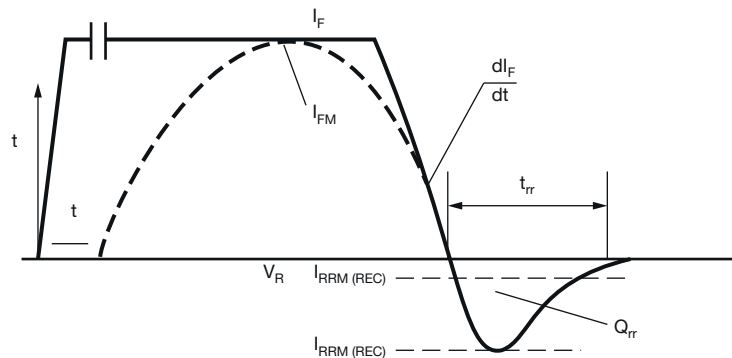

- I_F , I_{FM} - Peak forward current prior to commutation
 $-di_F/dt$ - Rate of fall forward current
 $I_{RRM(REC)}$ - Peak reverse recovery current
 t_{rr} - Reverse recovery time
 Q_{rr} - Reverse recovered charge

Fig. 1 - Reverse Recovery Time Test Waveform

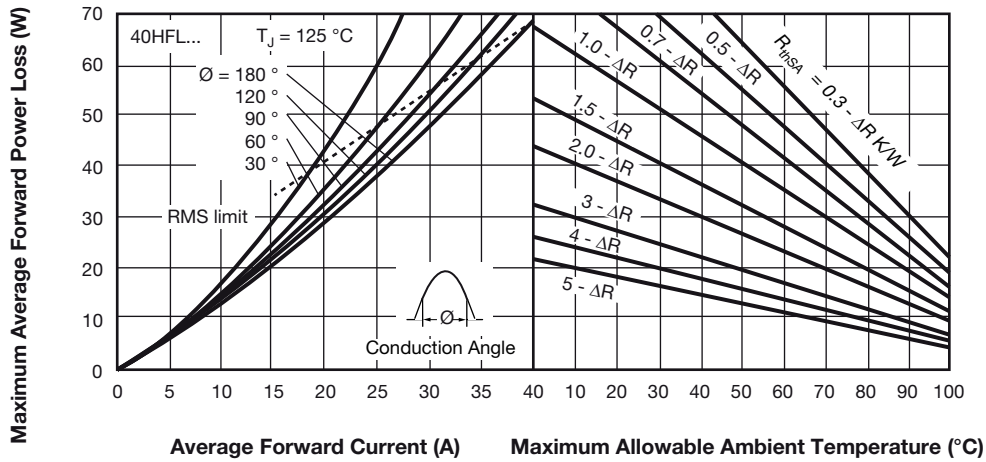

Fig. 2 - Current Rating Nomogram (Sinusoidal Waveforms), 40HFL Series

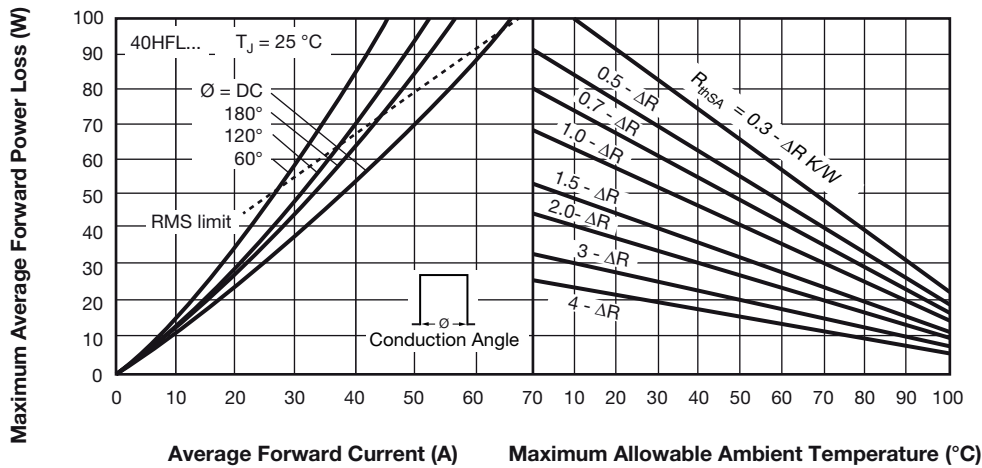

Fig. 3 - Current Rating Nomogram (Rectangular Waveforms), 40HFL Series

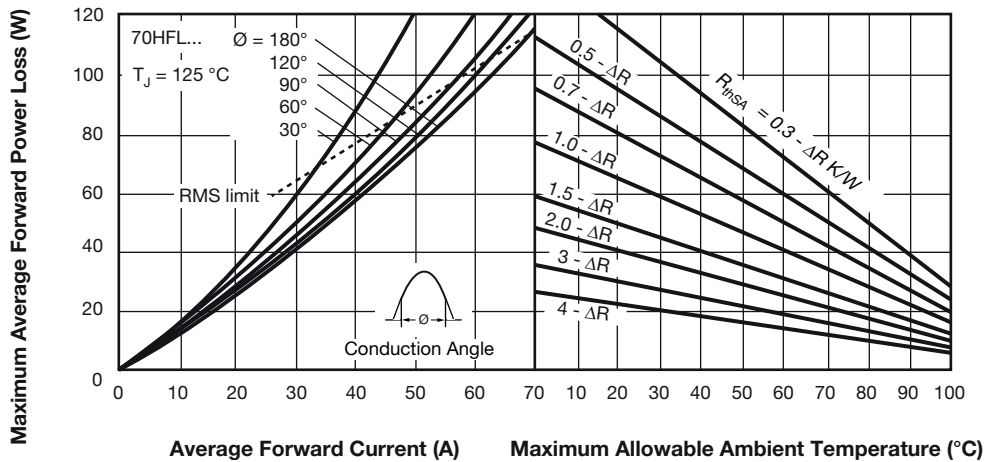

Fig. 4 - Current Rating Nomogram (Sinusoidal Waveforms), 70HFL Series

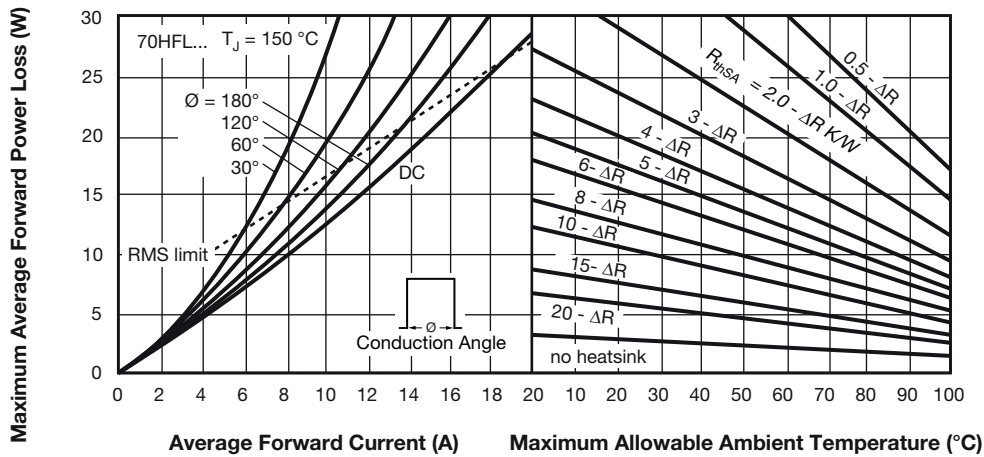

Fig. 5 - Current Rating Nomogram (Rectangular Waveforms), 70HFL Series

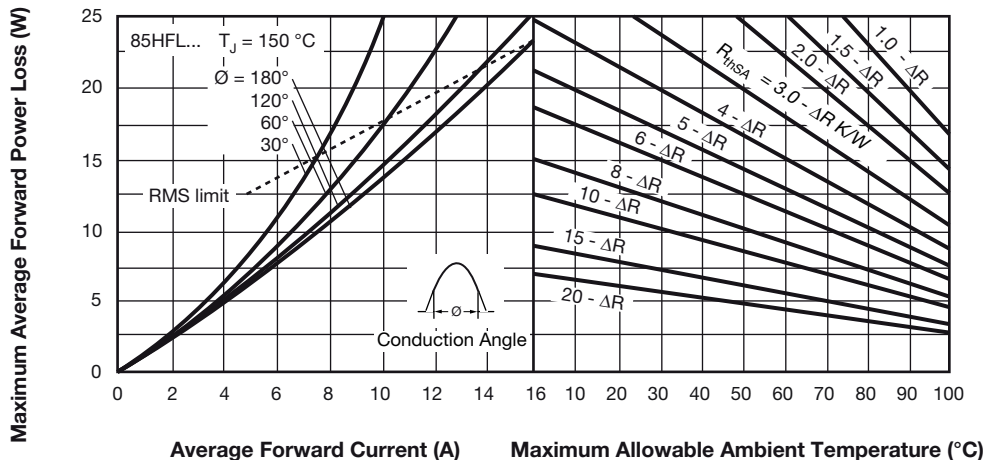

Fig. 6 - Current Rating Nomogram (Sinusoidal Waveforms), 85HFL Series

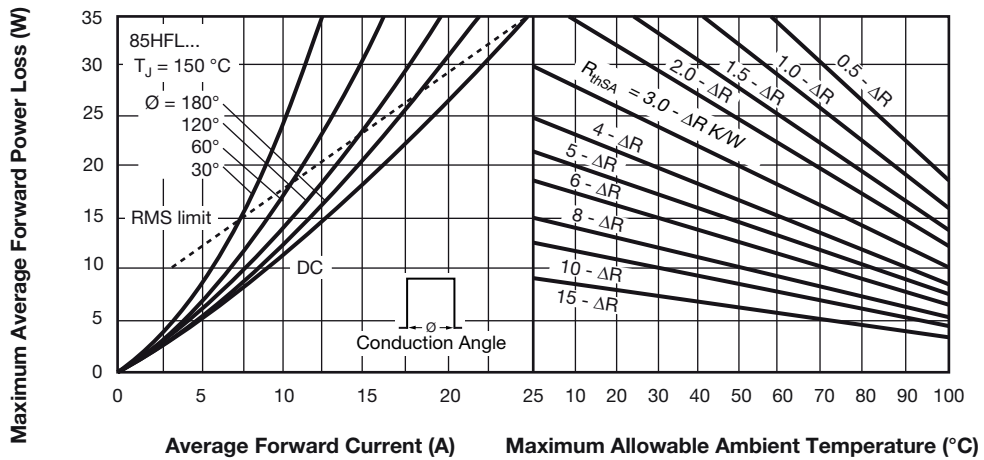

Fig. 7 - Current Rating Nomogram (Rectangular Waveforms), 85HFL Series

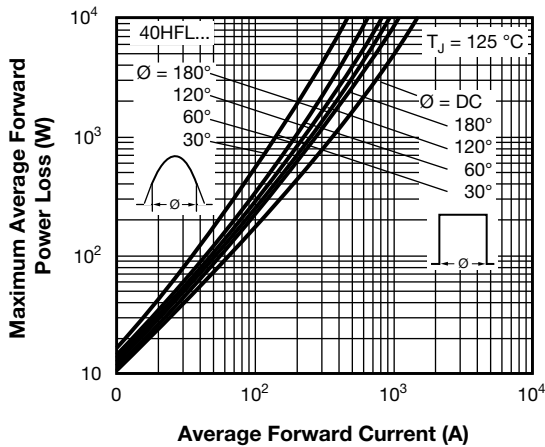

Fig. 8 - Maximum High Level Forward Power Loss vs. Average Forward Current, 40HFL Series

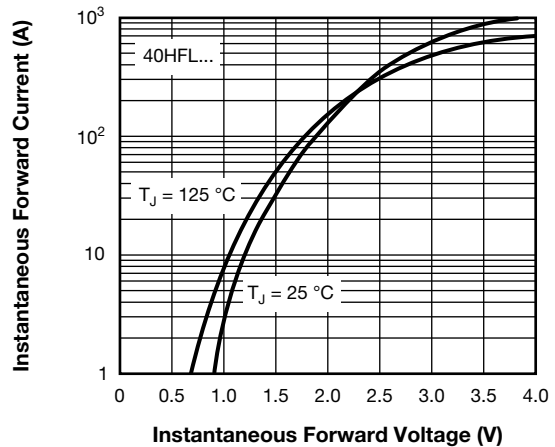

Fig. 11 - Maximum Forward Voltage vs. Forward Current, 40HFL Series

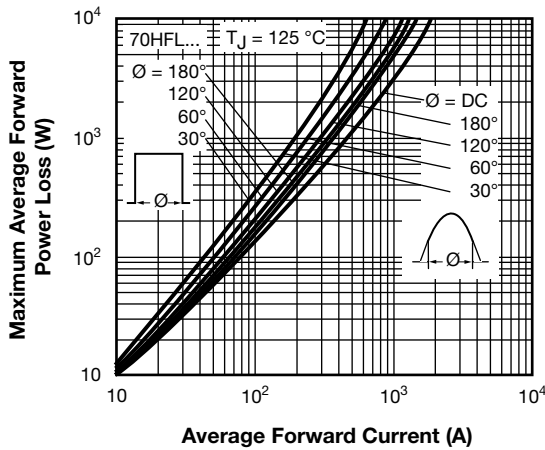

Fig. 9 - Maximum High Level Forward Power Loss vs. Average Forward Current, 70HFL Series

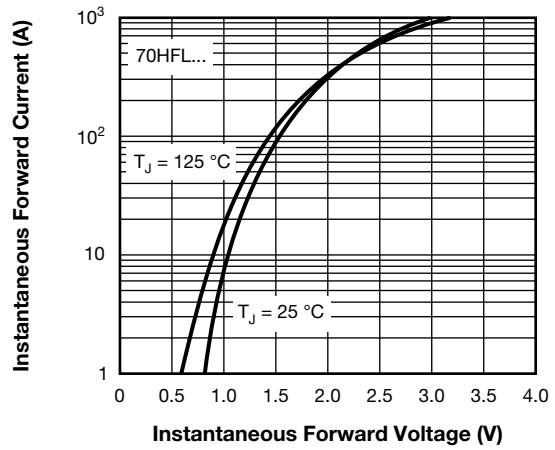

Fig. 12 - Maximum Forward Voltage vs. Forward Current, 70HFL Series

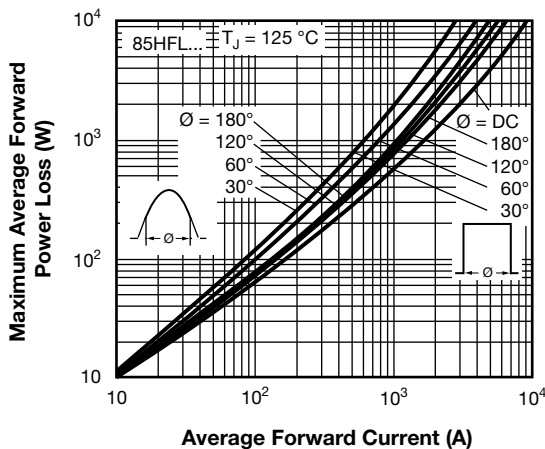

Fig. 10 - Maximum High Level Forward Power Loss vs. Average Forward Current, 85HFL Series

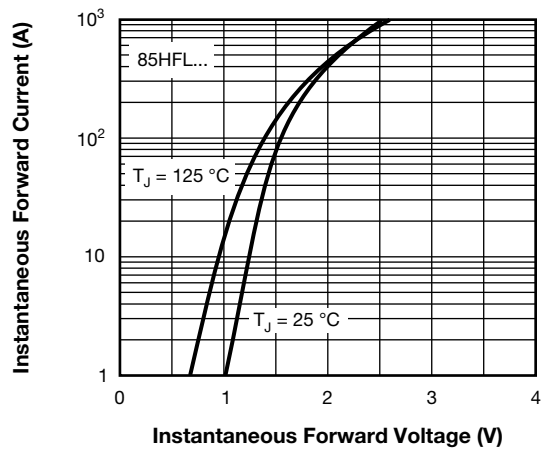

Fig. 13 - Maximum Forward Voltage vs. Forward Current, 85HFL Series

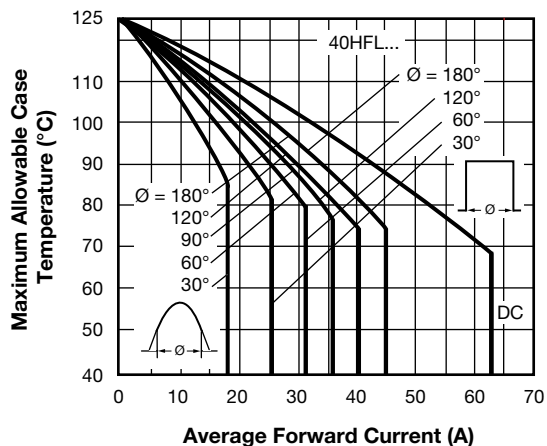

Fig. 14 - Average Forward Current vs. Maximum Allowable Case Temperature, 40HFL Series

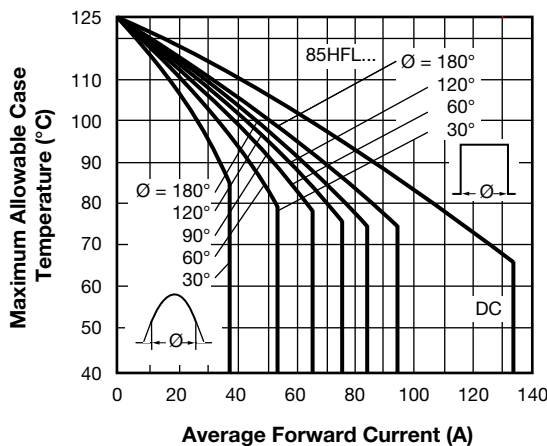

Fig. 16 - Average Forward Current vs. Maximum Allowable Case Temperature, 85HFL Series

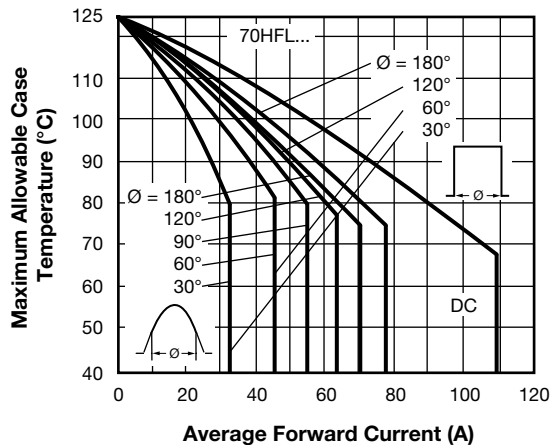

Fig. 15 - Average Forward Current vs. Maximum Allowable Case Temperature, 70HFL Series

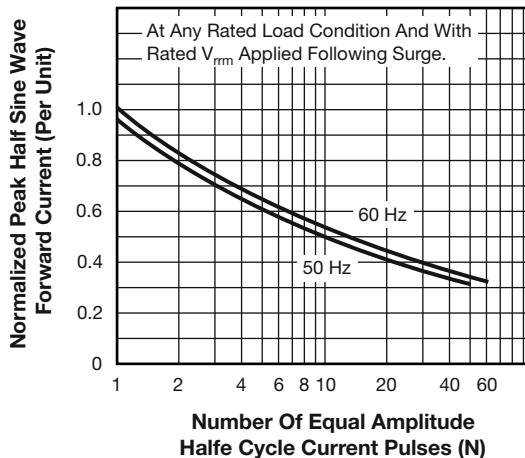

Fig. 17 - Maximum Non-Repetitive Surge Current vs. Number of Current Pulses, All Series

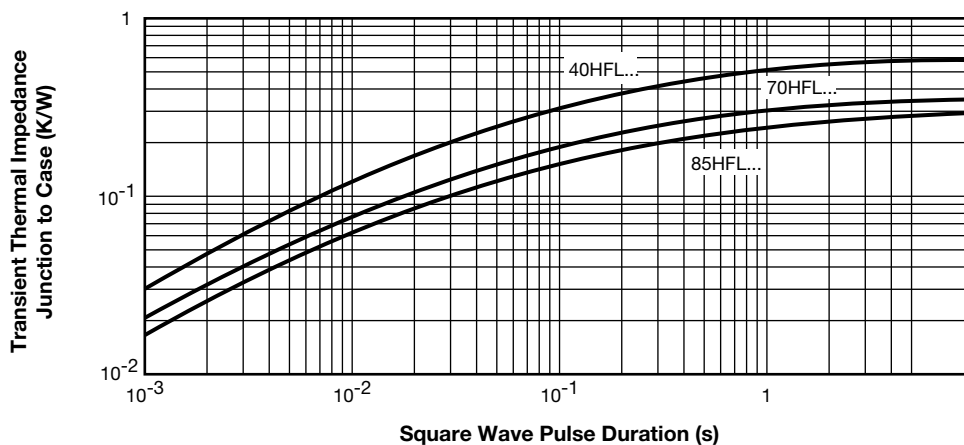

Fig. 18 - Maximum Transient Thermal Impedance, Junction to Case vs. Pulse Duration, All Series

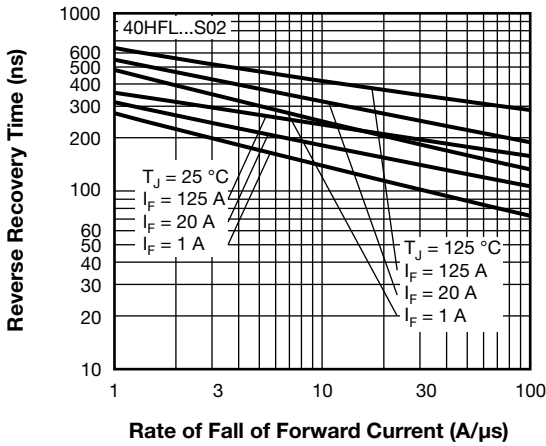

Fig. 19 - Typical Reverse Recovery Time vs. Rate of Fall of Forward Current, 40HFL...S02 Series

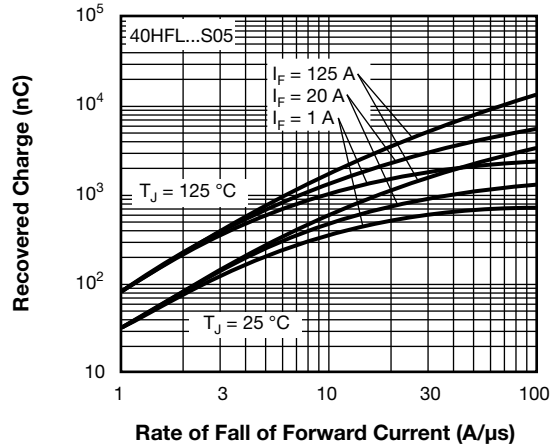

Fig. 22 - Typical Recovered Charge vs. Rate of Fall of Forward Current, 40HFL...S05 Series

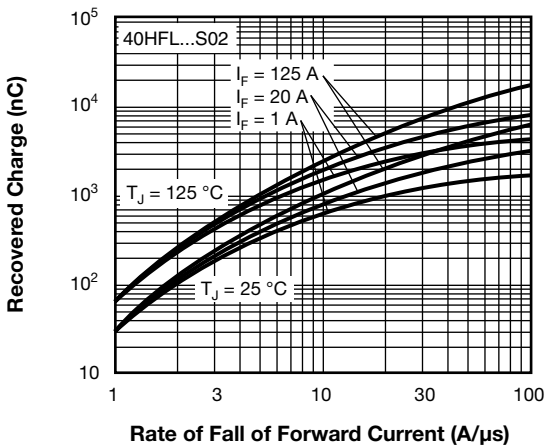

Fig. 20 - Typical Recovered Charge vs. Rate of Fall of Forward Current, 40HFL...S02 Series

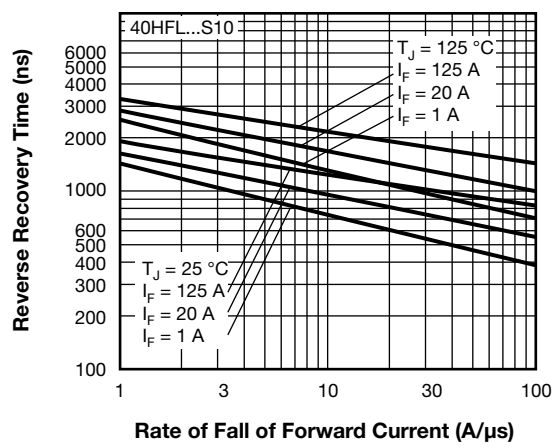

Fig. 23 - Typical Reverse Recovery Time vs. Rate of Fall of Forward Current, 40HFL...Series

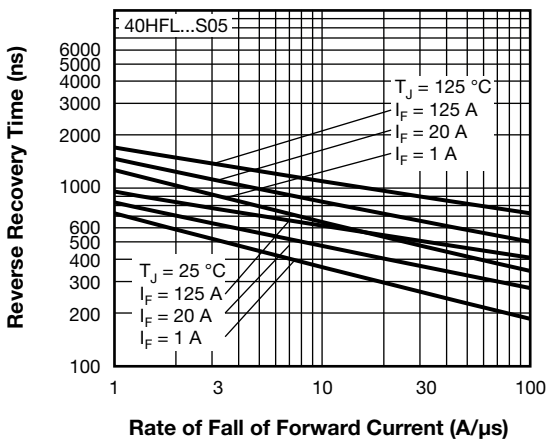

Fig. 21 - Typical Reverse Recovery Time vs. Rate of Fall of Forward Current, 40HFL...S05 Series

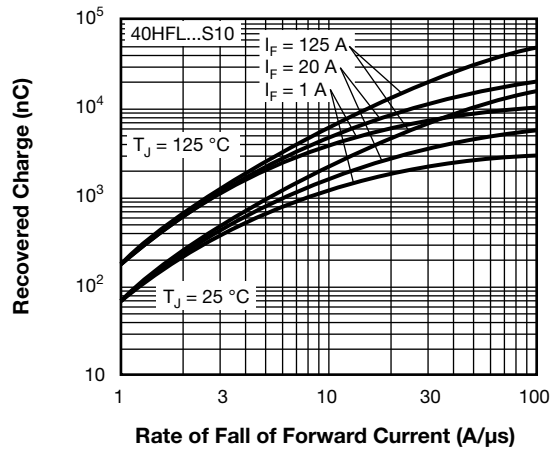

Fig. 24 - Typical Recovered Charge vs. Rate of Fall of Forward Current, 40HFL...Series

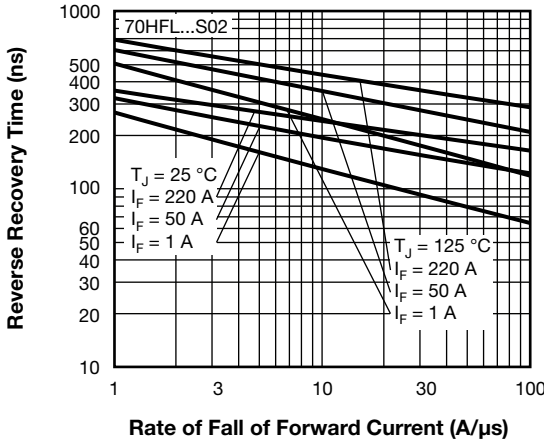

Fig. 25 - Typical Reverse Recovery Time vs. Rate of Fall of Forward Current, 70HFL...S02 Series

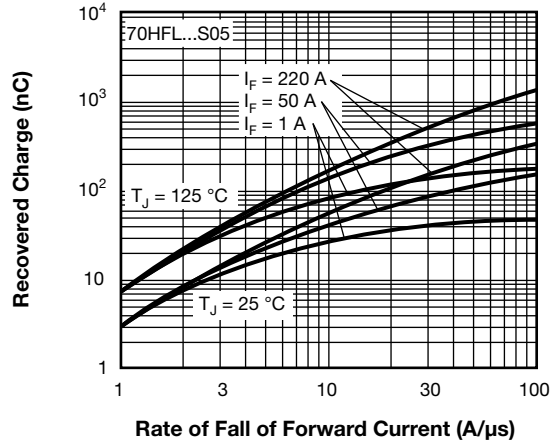

Fig. 28 - Typical Recovered Charge vs. Rate of Fall of Forward Current, 70HFL...S05 Series

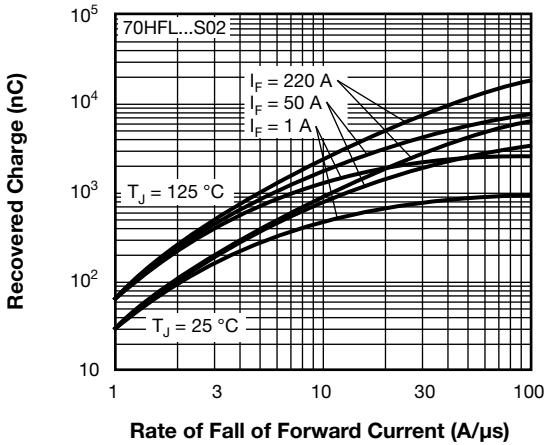

Fig. 26 - Typical Recovered Charge vs. Rate of Fall of Forward Current, 70HFL...S02 Series

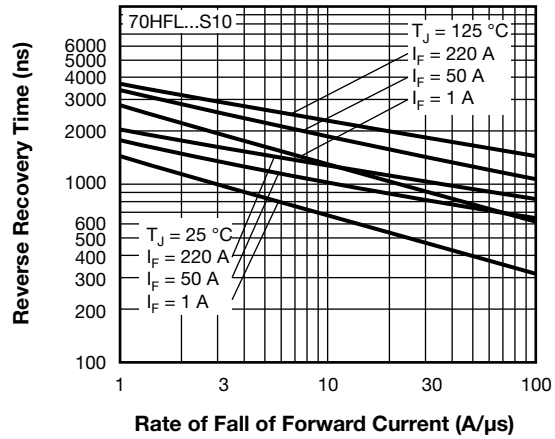

Fig. 29 - Typical Reverse Recovery Time vs. Rate of Fall of Forward Current, 70HFL... Series

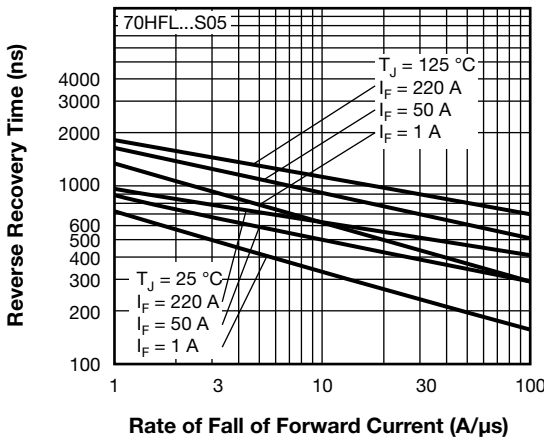

Fig. 27 - Typical Reverse Recovery Time vs. Rate of Fall of Forward Current, 70HFL...S05 Series

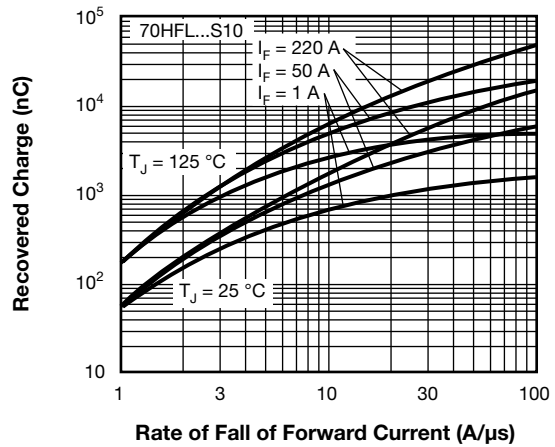
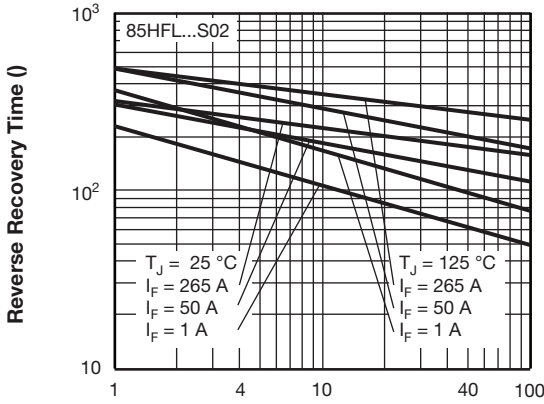
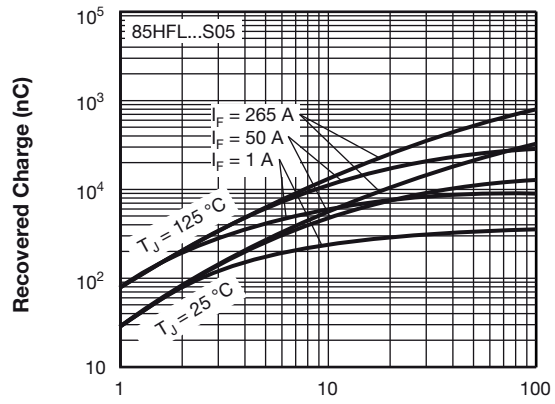

Fig. 30 - Typical Recovered Charge vs. Rate of Fall of Forward Current, 70HFL... Series



Rate of Fall of Forward Current (A/μs)
 Fig. 31 - Typical Reverse Recovery Time vs. Rate of Fall of Forward Current, 85HFL...S02 Series



Rate of Fall of Forward Current (A/μs)
 Fig. 34 - Typical Recovered Charge vs. Rate of Fall of Forward Current, 85HFL...S05 Series

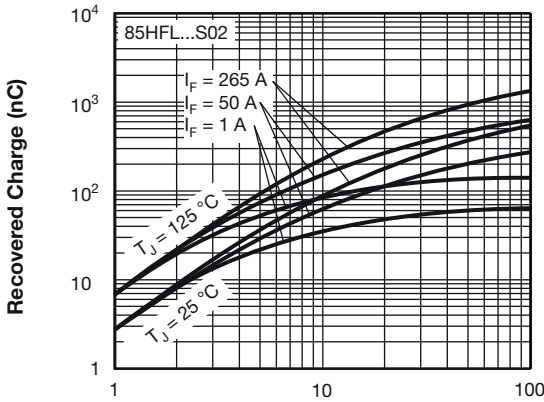

Rate of Fall of Forward Current (A/μs)
 Fig. 32 - Typical Recovered Charge vs. Rate of Fall of Forward Current, 85HFL...S02 Series

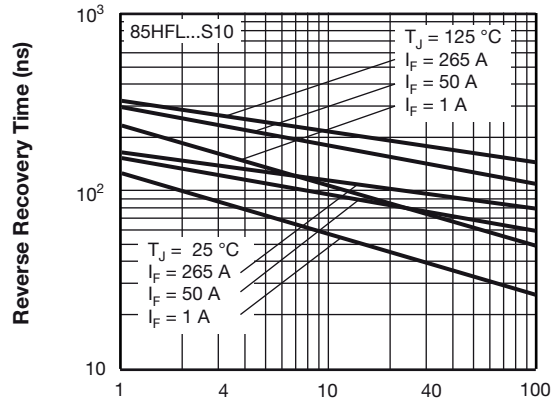

Rate of Fall of Forward Current (A/μs)
 Fig. 35 - Typical Reverse Recovery Time vs. Rate of Fall of Forward Current, 85HFL... Series

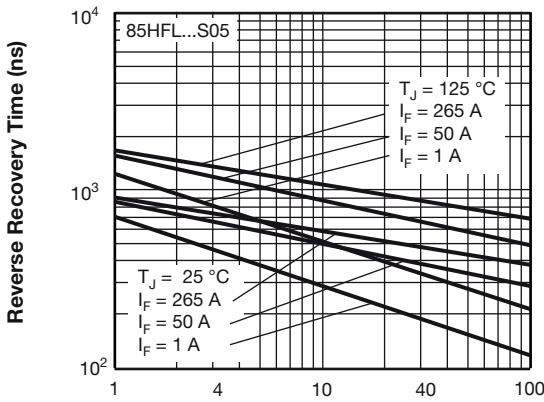

Rate of Fall of Forward Current (A/μs)
 Fig. 33 - Typical Reverse Recovery Time vs. Rate of Fall of Forward Current, 85HFL...S05 Series

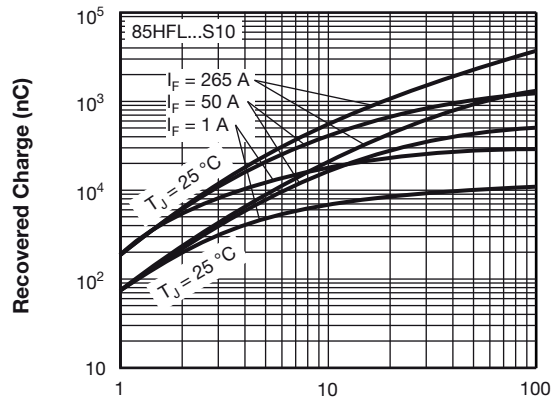

Rate of Fall of Forward Current (A/μs)
 Fig. 36 - Typical Recovered Charge vs. Rate of Fall of Forward Current, 85HFL... Series



ORDERING INFORMATION TABLE

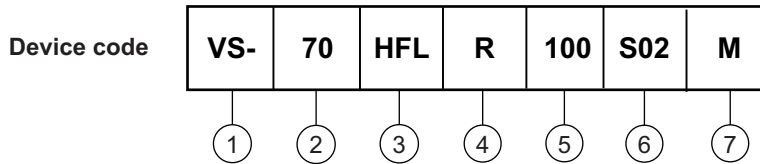

- 1** - Vishay Semiconductors product
- 2** -
 - 70 = standard device (current rating: 40 = 40 A, 70 = 70 A, 85 = 85 A)
 - 71 = not isolated lead
 - 72, 87 = isolated lead with silicone sleeve
(red = reverse polarity)
(blue = normal polarity)
- 3** - HFL = fast recovery diode
- 4** -
 - None = stud normal polarity (cathode to stud)
 - R = stud reverse polarity (anode to stud)
- 5** - Voltage code x 10 = V_{RRM} (see "Voltage Ratings" table)
- 6** - Refer to "Recovery Characteristics" table
- 7** -
 - None = stud base DO-5 (DO-203AB) 1/4" 28UNF-2A
 - M = stud base DO-5 (DO-203AB) M6 x 1

| LINKS TO RELATED DOCUMENTS | |
|----------------------------|--|
| Dimensions | www.vishay.com/doc?95312 |

DO-203AB (DO-5) for 40HFL, 70HFL and 85HFL

DIMENSIONS FOR 40HFL/70HFL in millimeters (inches)

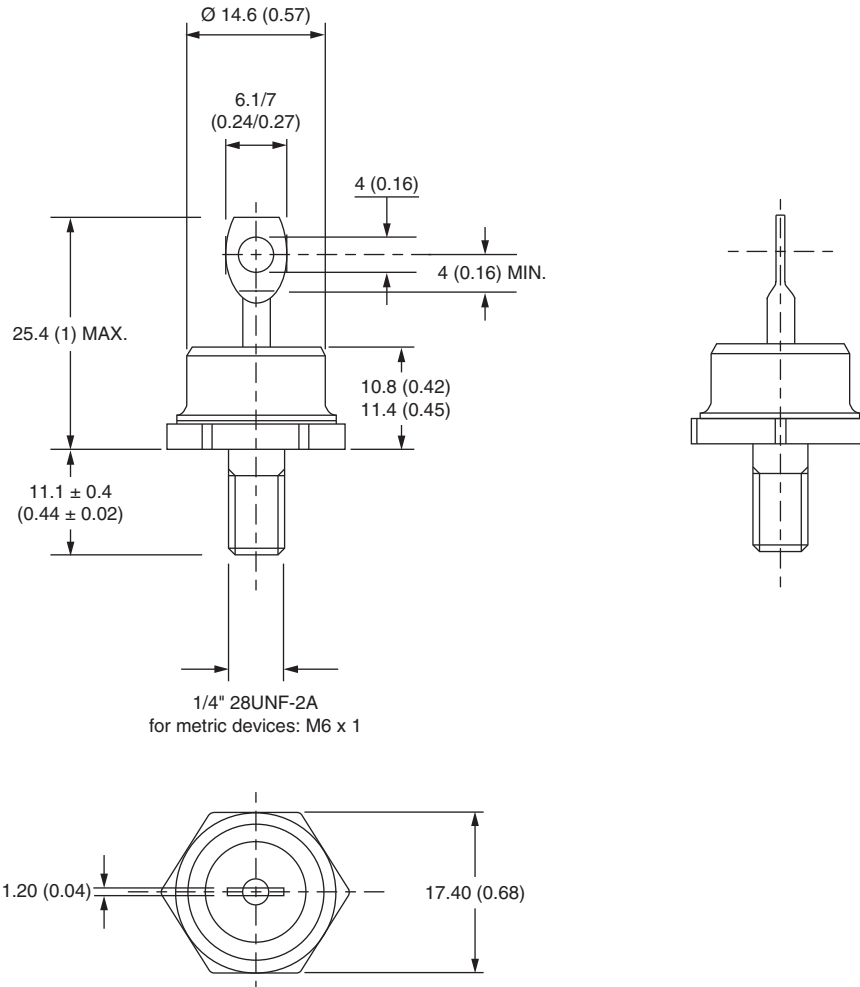

Outline Dimensions

Vishay Semiconductors

DO-203AB (DO-5) for
40HFL, 70HFL and 85HFL



DIMENSIONS FOR 85HFL in millimeters (inches)

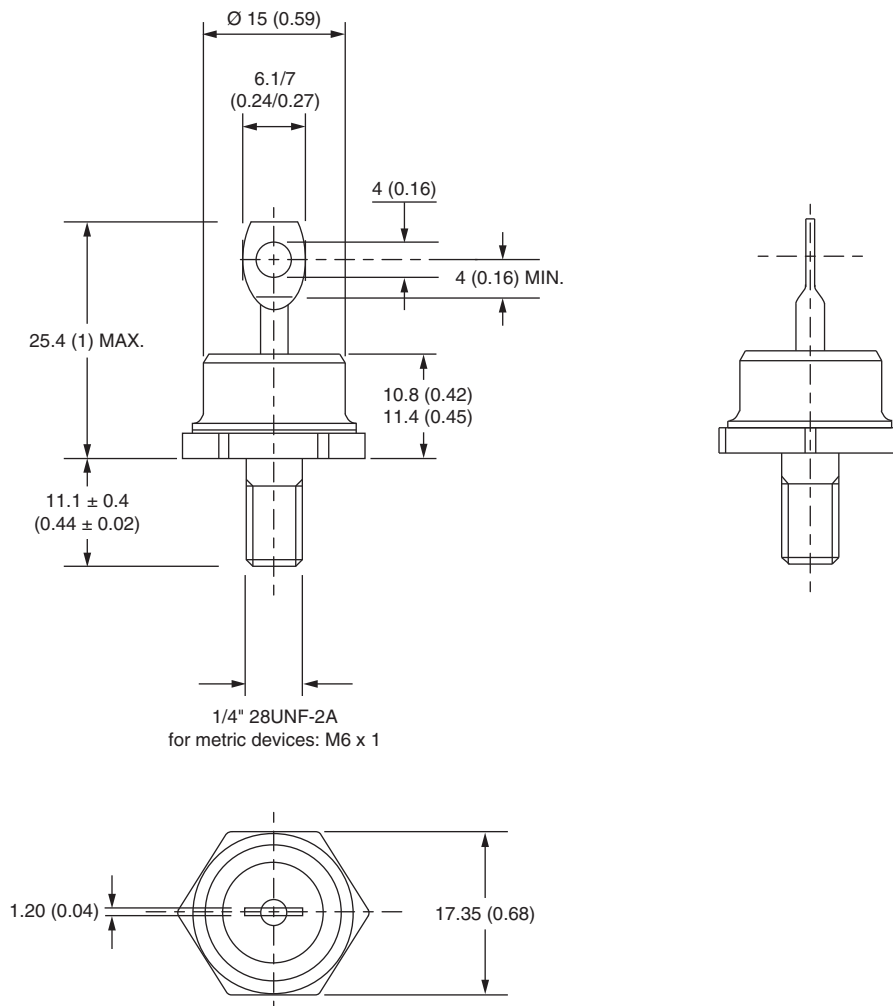



Disclaimer

ALL PRODUCT, PRODUCT SPECIFICATIONS AND DATA ARE SUBJECT TO CHANGE WITHOUT NOTICE TO IMPROVE RELIABILITY, FUNCTION OR DESIGN OR OTHERWISE.

Vishay Intertechnology, Inc., its affiliates, agents, and employees, and all persons acting on its or their behalf (collectively, "Vishay"), disclaim any and all liability for any errors, inaccuracies or incompleteness contained in any datasheet or in any other disclosure relating to any product.

Vishay makes no warranty, representation or guarantee regarding the suitability of the products for any particular purpose or the continuing production of any product. To the maximum extent permitted by applicable law, Vishay disclaims (i) any and all liability arising out of the application or use of any product, (ii) any and all liability, including without limitation special, consequential or incidental damages, and (iii) any and all implied warranties, including warranties of fitness for particular purpose, non-infringement and merchantability.

Statements regarding the suitability of products for certain types of applications are based on Vishay's knowledge of typical requirements that are often placed on Vishay products in generic applications. Such statements are not binding statements about the suitability of products for a particular application. It is the customer's responsibility to validate that a particular product with the properties described in the product specification is suitable for use in a particular application. Parameters provided in datasheets and / or specifications may vary in different applications and performance may vary over time. All operating parameters, including typical parameters, must be validated for each customer application by the customer's technical experts. Product specifications do not expand or otherwise modify Vishay's terms and conditions of purchase, including but not limited to the warranty expressed therein.

Hyperlinks included in this datasheet may direct users to third-party websites. These links are provided as a convenience and for informational purposes only. Inclusion of these hyperlinks does not constitute an endorsement or an approval by Vishay of any of the products, services or opinions of the corporation, organization or individual associated with the third-party website. Vishay disclaims any and all liability and bears no responsibility for the accuracy, legality or content of the third-party website or for that of subsequent links.

Vishay products are not designed for use in life-saving or life-sustaining applications or any application in which the failure of the Vishay product could result in personal injury or death unless specifically qualified in writing by Vishay. Customers using or selling Vishay products not expressly indicated for use in such applications do so at their own risk. Please contact authorized Vishay personnel to obtain written terms and conditions regarding products designed for such applications.

No license, express or implied, by estoppel or otherwise, to any intellectual property rights is granted by this document or by any conduct of Vishay. Product names and markings noted herein may be trademarks of their respective owners.