

## Ultrafast Rectifier, 30 A FRED Pt®

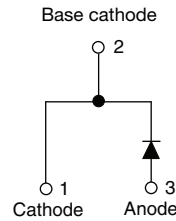

### FEATURES

- Ultrafast and soft recovery
- Optimized forward voltage drop
- 175 °C maximum operating junction temperature
- Polyimide passivation
- Rugged design
- Good thermal performance
- Designed and qualified according to JEDEC®-JESD 47
- Material categorization: for definitions of compliance please see [www.vishay.com/doc?99912](http://www.vishay.com/doc?99912)

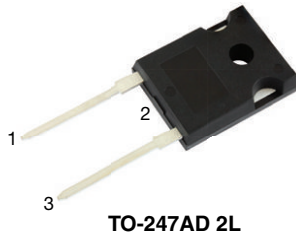

**RoHS**  
COMPLIANT  
**HALOGEN**  
**FREE**

PRIMARY CHARACTERISTICS	
$I_{F(AV)}$	30 A
$V_R$	1200 V
$V_F$ at $I_F$ at 125 °C	2.05 V
$t_{rr}$	49 ns
$T_J$ max.	175 °C
Package	TO-247AD 2L
Circuit configuration	Single

### DESCRIPTION / APPLICATIONS

Ultrafast recovery rectifiers designed with optimized performance of forward voltage drop, recovery time, and soft recovery. Polyimide passivated, planar structure, and the platinum doped life time control guarantee, ruggedness, reliability characteristics, and solid value proposition for efficiency and thermal performance.

These devices are intended for use in boost stage in the AC/DC section of SMPS, high frequency output rectification of battery charger, inverters for solar inverters, or as freewheeling diodes in motor drive.

ABSOLUTE MAXIMUM RATINGS				
PARAMETER	SYMBOL	TEST CONDITIONS	VALUES	UNITS
Repetitive peak reverse voltage	$V_{RRM}$		1200	V
Average rectified forward current	$I_{F(AV)}$	$T_C = 135\text{ °C}$ , $D = 0.50$	30	A
Non-repetitive peak surge current	$I_{FSM}$	$T_C = 25\text{ °C}$ , $t_p = 10\text{ ms}$ , sine wave	300	
Repetitive peak forward current	$I_{FRM}$		60	
Operating junction and storage temperature	$T_J, T_{Stg}$		-55 to +175	°C

ELECTRICAL SPECIFICATIONS ( $T_J = 25\text{ °C}$ unless otherwise specified)						
PARAMETER	SYMBOL	TEST CONDITIONS	MIN.	TYP.	MAX.	UNITS
Breakdown voltage, blocking voltage	$V_{BR}, V_R$	$I_R = 500\text{ }\mu\text{A}$	1200	-	-	V
Forward voltage	$V_F$	$I_F = 30\text{ A}$	-	2.15	2.68	
		$I_F = 30\text{ A}$ , $T_J = 125\text{ °C}$	-	2.05	2.45	
Reverse leakage current	$I_R$	$V_R = V_R$ rated	-	-	145	$\mu\text{A}$
		$T_J = 125\text{ °C}$ , $V_R = V_R$ rated	-	-	320	
Junction capacitance	$C_T$	$V_R = 200\text{ V}$	-	29	-	pF
Series inductance	$L_S$	Measured to lead 5 mm from package body	-	8	-	nH



<b>DYNAMIC RECOVERY CHARACTERISTICS</b> ( $T_J = 25\text{ }^\circ\text{C}$ unless otherwise specified)						
PARAMETER	SYMBOL	TEST CONDITIONS	MIN.	TYP.	MAX.	UNITS
Reverse recovery time	$t_{rr}$	$I_F = 1.0\text{ A}$ , $di_F/dt = 100\text{ A}/\mu\text{s}$ , $V_R = 30\text{ V}$	-	49	-	ns
		$T_J = 25\text{ }^\circ\text{C}$	-	220	-	
		$T_J = 125\text{ }^\circ\text{C}$	-	356	-	
Peak recovery current	$I_{RRM}$	$T_J = 25\text{ }^\circ\text{C}$	-	8.2	-	A
		$T_J = 125\text{ }^\circ\text{C}$	-	13.3	-	
Reverse recovery charge	$Q_{rr}$	$T_J = 25\text{ }^\circ\text{C}$	-	900	-	nC
		$T_J = 125\text{ }^\circ\text{C}$	-	2388	-	

<b>THERMAL - MECHANICAL SPECIFICATIONS</b>						
PARAMETER	SYMBOL	TEST CONDITIONS	MIN.	TYP.	MAX.	UNITS
Thermal resistance, junction to case	$R_{thJC}$		-	0.35	0.42	$^\circ\text{C}/\text{W}$
Thermal resistance, junction to ambient	$R_{thJA}$	Typical socket mount	-	30	33	
Thermal resistance, case to heat sink	$R_{thCS}$	Mounting surface, flat, smooth, and greased	-	0.25	0.4	
Weight			-	6	-	g
Mounting torque			6.0 (5.0)	-	12 (10)	kgf · cm (lbf · in)
Maximum junction and storage temperature range	$T_J, T_{Stg}$		-55	-	175	$^\circ\text{C}$
Marking device		Case style: TO-247AD 2L	30EPU12L			

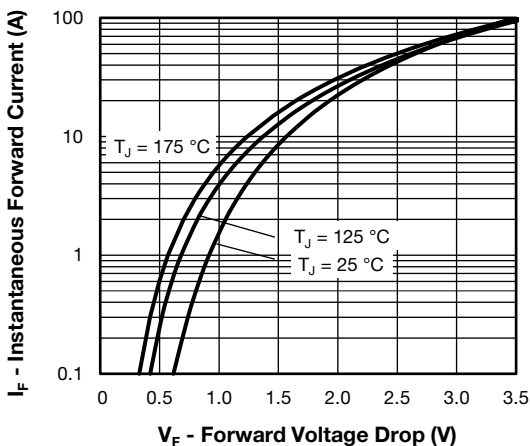

Fig. 1 - Typical Forward Voltage Drop Characteristics

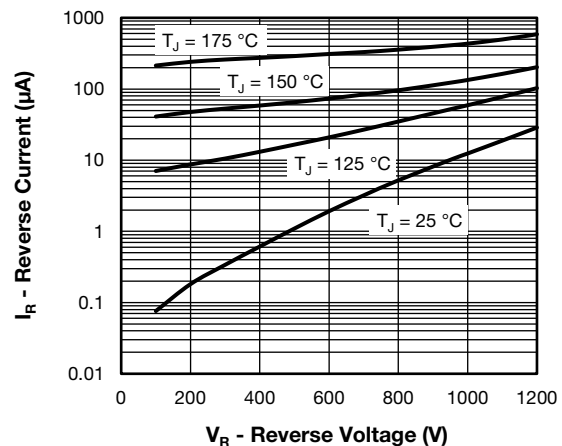

Fig. 2 - Typical Values of Reverse Current vs. Reverse Voltage

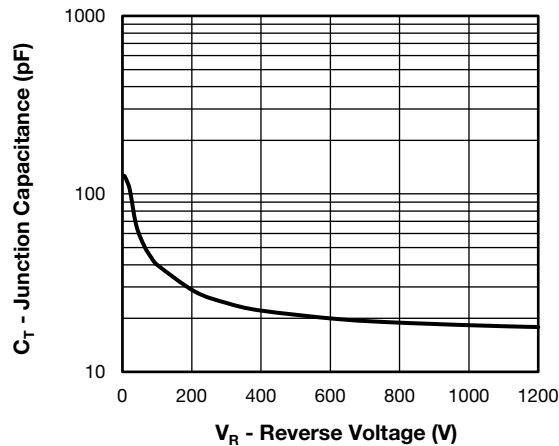

Fig. 3 - Typical Junction Capacitance vs. Reverse Voltage

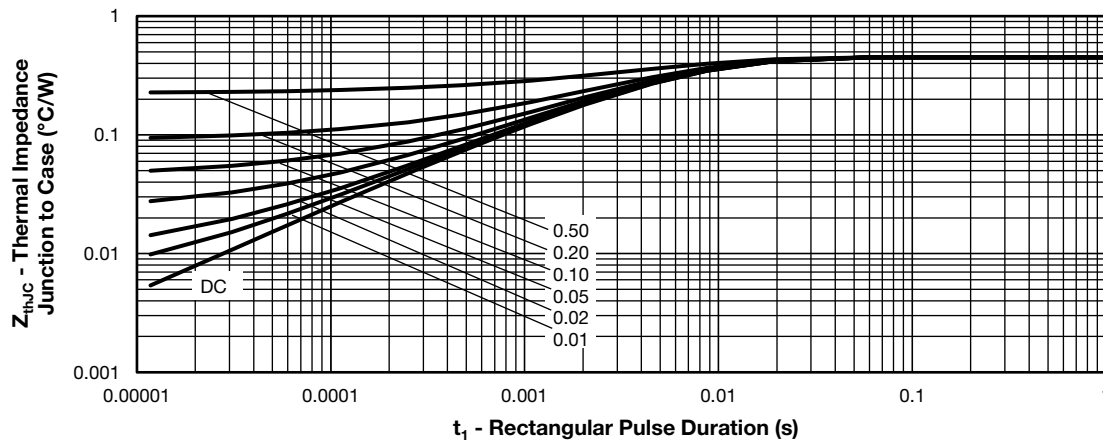

Fig. 4 - Maximum Thermal Impedance  $Z_{thJC}$  Characteristics

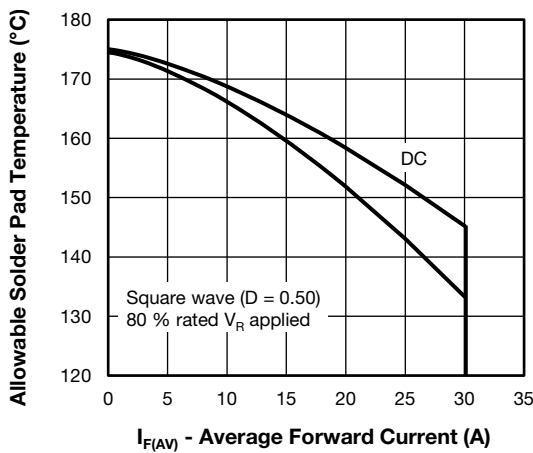

Fig. 5 - Maximum Allowable Case Temperature vs. Average Forward Current

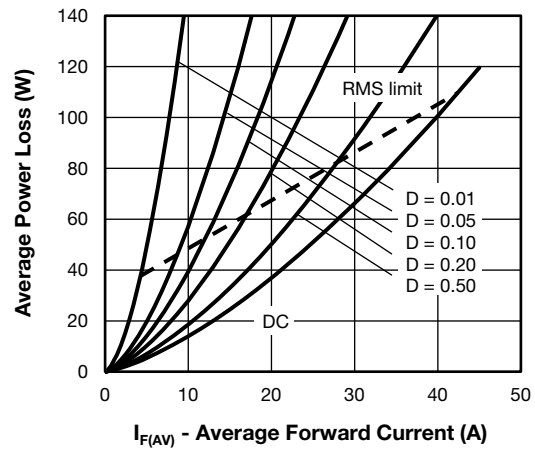

Fig. 6 - Forward Power Loss Characteristics

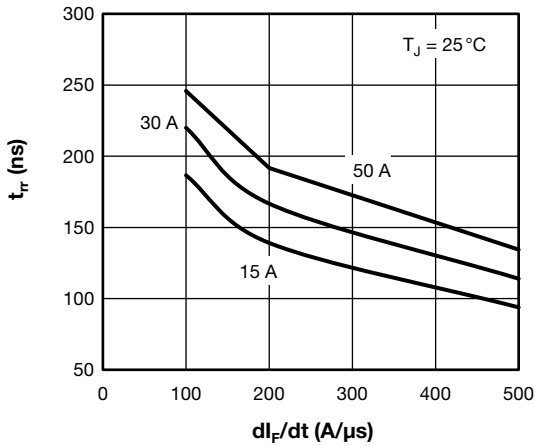

Fig. 7 - Typical Reverse Recovery Time vs.  $dI_F/dt$

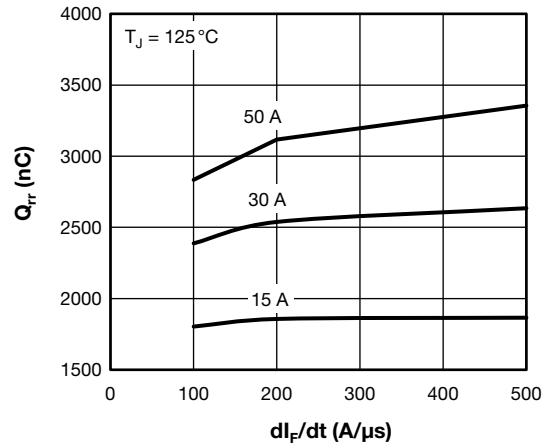

Fig. 10 - Typical Stored Charge vs.  $dI_F/dt$

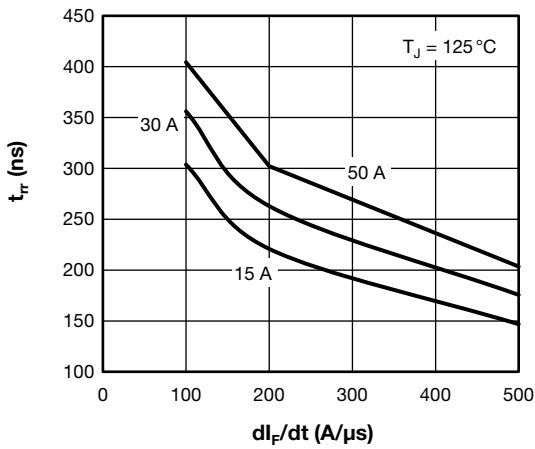

Fig. 8 - Typical Reverse Recovery Time vs.  $dI_F/dt$

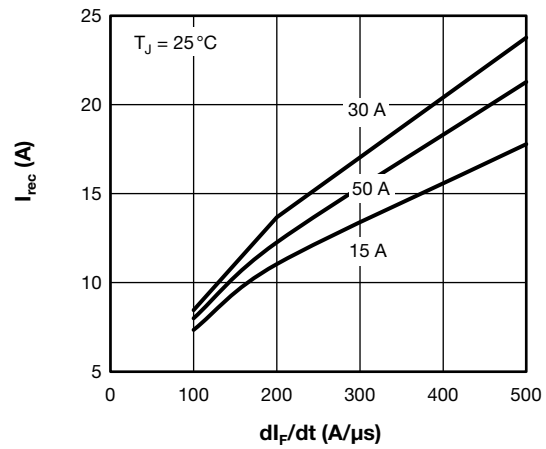

Fig. 11 - Typical Reverse Current vs.  $dI_F/dt$

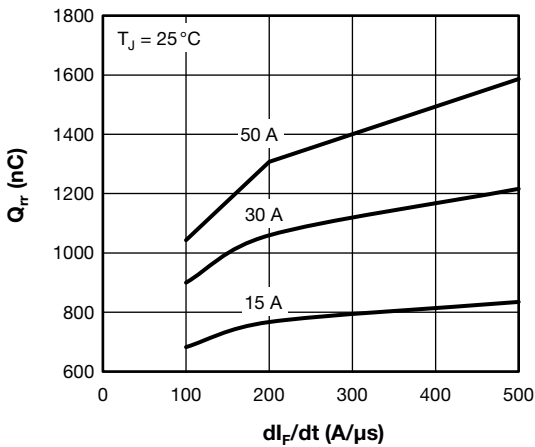

Fig. 9 - Typical Stored Charge vs.  $dI_F/dt$

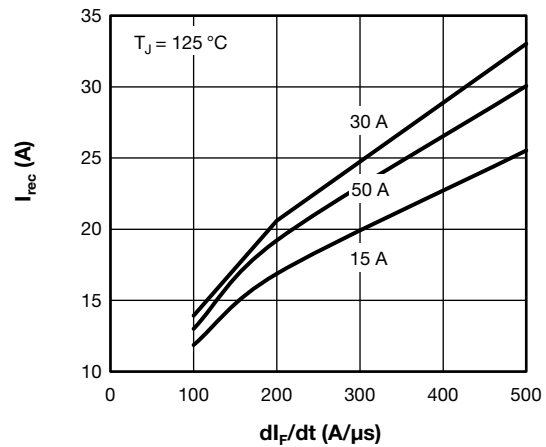
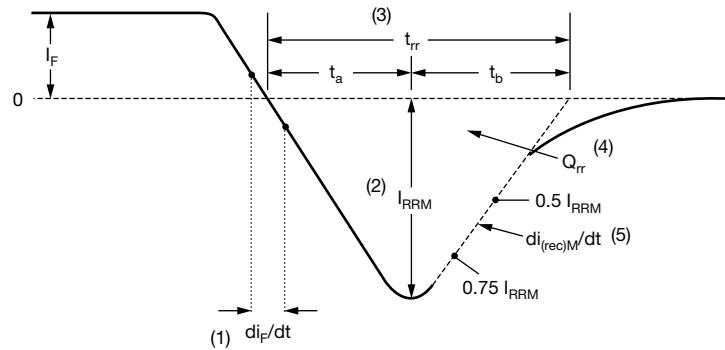

Fig. 12 - Typical Reverse Current vs.  $dI_F/dt$



- (1)  $di_F/dt$  - rate of change of current through zero crossing
- (2)  $I_{RRM}$  - peak reverse recovery current
- (3)  $t_{rr}$  - reverse recovery time measured from zero crossing point of negative going  $I_F$  to point where a line passing through  $0.75 I_{RRM}$  and  $0.50 I_{RRM}$  extrapolated to zero current.
- (4)  $Q_{rr}$  - area under curve defined by  $t_{rr}$  and  $I_{RRM}$
- $$Q_{rr} = \frac{t_{rr} \times I_{RRM}}{2}$$
- (5)  $di_{(rec)M}/dt$  - peak rate of change of current during  $t_b$  portion of  $t_{rr}$

Fig. 13 - Reverse Recovery Waveform and Definitions

**ORDERING INFORMATION TABLE**

Device code	<b>VS-</b>	<b>30</b>	<b>E</b>	<b>P</b>	<b>U</b>	<b>12</b>	<b>L</b>	<b>-N3</b>
	①	②	③	④	⑤	⑥	⑦	⑧

- 1** - Vishay Semiconductors product
- 2** - Current rating (30 = 30 A)
- 3** - Circuit configuration: E = single diode
- 4** - P = TO-247 package
- 5** - Process type:  
U = ultrafast recovery
- 6** - Voltage rating (12 = 1200 V)
- 7** - L = long leads
- 8** - Environmental digit:  
-N3 = halogen-free, RoHS-compliant, and totally lead (Pb)-free

ORDERING INFORMATION (Example)			
PREFERRED P/N	QUANTITY PER TUBE	MINIMUM ORDER QUANTITY	PACKAGING DESCRIPTION
VS-30EPU12L-N3	25	500	Antistatic plastic tube

LINKS TO RELATED DOCUMENTS	
Dimensions	<a href="http://www.vishay.com/doc?95536">www.vishay.com/doc?95536</a>
Part marking information	<a href="http://www.vishay.com/doc?95648">www.vishay.com/doc?95648</a>

### TO-247AD 2L

**DIMENSIONS** in millimeters and inches

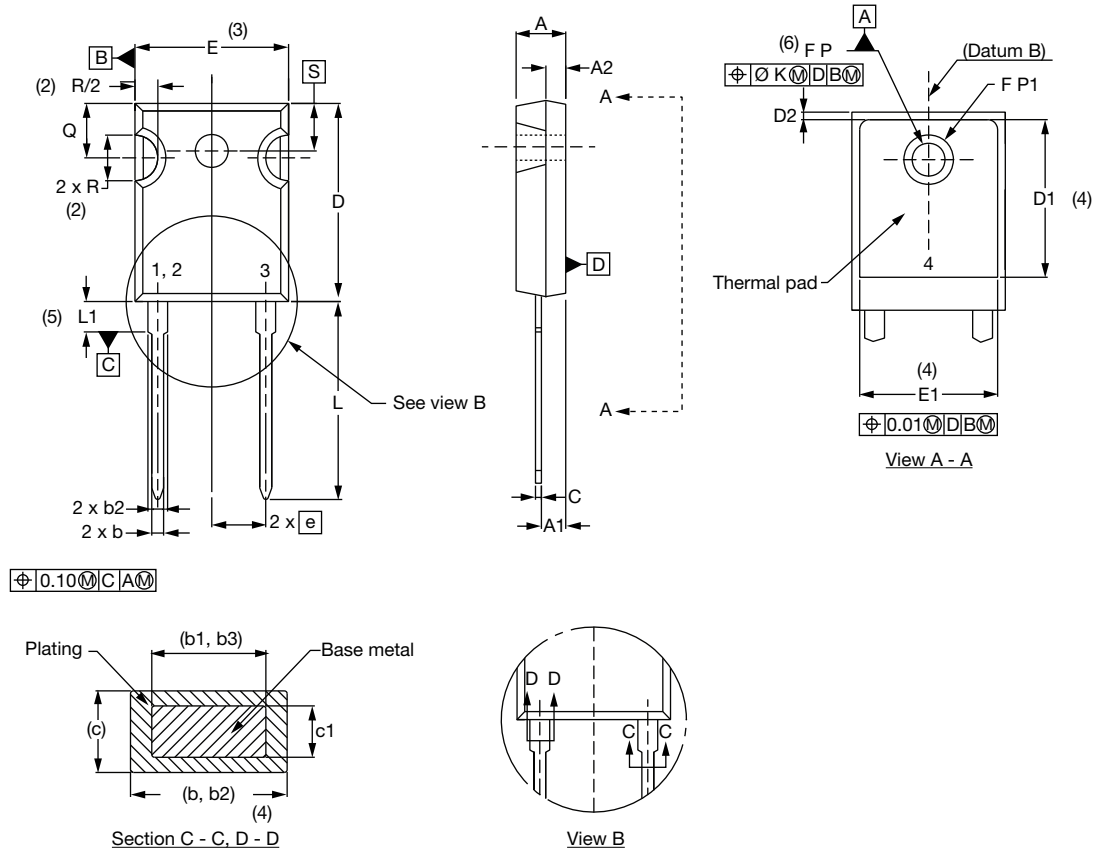

SYMBOL	MILLIMETERS		INCHES		NOTES	SYMBOL	MILLIMETERS		INCHES		NOTES
	MIN.	MAX.	MIN.	MAX.			MIN.	MAX.	MIN.	MAX.	
A	4.65	5.31	0.183	0.209		E	15.29	15.87	0.602	0.625	3
A1	2.21	2.59	0.087	0.102		E1	13.46	-	0.53	-	
A2	1.50	2.49	0.059	0.098		e	5.46 BSC		0.215 BSC		
b	0.99	1.40	0.039	0.055		$\phi K$	0.254		0.010		
b1	0.99	1.35	0.039	0.053		L	19.81	20.32	0.780	0.800	
b2	1.65	2.39	0.065	0.094		L1	3.71	4.29	0.146	0.169	
b3	1.65	2.34	0.065	0.092		$\phi P$	3.56	3.66	0.14	0.144	
c	0.38	0.89	0.015	0.035		$\phi P1$	-	6.98	-	0.275	
c1	0.38	0.84	0.015	0.033		Q	5.31	5.69	0.209	0.224	
D	19.71	20.70	0.776	0.815	3	R	4.52	5.49	0.178	0.216	
D1	13.08	-	0.515	-	4	S	5.51 BSC		0.217 BSC		
D2	0.51	1.35	0.020	0.053							

**Notes**

- (1) Dimensioning and tolerancing per ASME Y14.5M-1994
- (2) Contour of slot optional
- (3) Dimension D and E do not include mold flash. These dimensions are measured at the outermost extremes of the plastic body
- (4) Thermal pad contour optional with dimensions D1 and E1
- (5) Lead finish uncontrolled in L1
- (6)  $\phi P$  to have a maximum draft angle of 1.5 to the top of the part with a maximum hole diameter of 3.91 mm (0.154")
- (7) Outline conforms to JEDEC® outline TO-247 with exception of dimension A min., D, E min., Q min., S, and note 4



## Disclaimer

ALL PRODUCT, PRODUCT SPECIFICATIONS AND DATA ARE SUBJECT TO CHANGE WITHOUT NOTICE TO IMPROVE RELIABILITY, FUNCTION OR DESIGN OR OTHERWISE.

Vishay Intertechnology, Inc., its affiliates, agents, and employees, and all persons acting on its or their behalf (collectively, "Vishay"), disclaim any and all liability for any errors, inaccuracies or incompleteness contained in any datasheet or in any other disclosure relating to any product.

Vishay makes no warranty, representation or guarantee regarding the suitability of the products for any particular purpose or the continuing production of any product. To the maximum extent permitted by applicable law, Vishay disclaims (i) any and all liability arising out of the application or use of any product, (ii) any and all liability, including without limitation special, consequential or incidental damages, and (iii) any and all implied warranties, including warranties of fitness for particular purpose, non-infringement and merchantability.

Statements regarding the suitability of products for certain types of applications are based on Vishay's knowledge of typical requirements that are often placed on Vishay products in generic applications. Such statements are not binding statements about the suitability of products for a particular application. It is the customer's responsibility to validate that a particular product with the properties described in the product specification is suitable for use in a particular application. Parameters provided in datasheets and / or specifications may vary in different applications and performance may vary over time. All operating parameters, including typical parameters, must be validated for each customer application by the customer's technical experts. Product specifications do not expand or otherwise modify Vishay's terms and conditions of purchase, including but not limited to the warranty expressed therein.

Hyperlinks included in this datasheet may direct users to third-party websites. These links are provided as a convenience and for informational purposes only. Inclusion of these hyperlinks does not constitute an endorsement or an approval by Vishay of any of the products, services or opinions of the corporation, organization or individual associated with the third-party website. Vishay disclaims any and all liability and bears no responsibility for the accuracy, legality or content of the third-party website or for that of subsequent links.

Vishay products are not designed for use in life-saving or life-sustaining applications or any application in which the failure of the Vishay product could result in personal injury or death unless specifically qualified in writing by Vishay. Customers using or selling Vishay products not expressly indicated for use in such applications do so at their own risk. Please contact authorized Vishay personnel to obtain written terms and conditions regarding products designed for such applications.

No license, express or implied, by estoppel or otherwise, to any intellectual property rights is granted by this document or by any conduct of Vishay. Product names and markings noted herein may be trademarks of their respective owners.