

Fast Switching Avalanche Surface-Mount Rectifiers

eSMP® Series

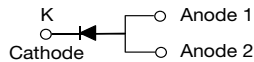

SMPC (TO-277A)



ADDITIONAL RESOURCES



PRIMARY CHARACTERISTICS	
$I_{F(AV)}$	4.0 A
V_{RRM}	200 V, 400 V, 600 V
I_{FSM}	65 A
t_{rr}	140 ns
E_{AS}	20 mJ
V_F at $I_F = 4.0$ A	1.02 V
T_J max.	175 °C
Package	SMPC (TO-277A)
Circuit configuration	Single

FEATURES

- Very low profile - typical height of 1.1 mm
- Ideal for automated placement
- Glass passivated pellet chip junction
- Fast reverse recovery time
- Controlled avalanche characteristics
- Low leakage current
- High forward surge capability
- Meets MSL level 1, per J-STD-020, LF maximum peak of 260 °C
- AEC-Q101 qualified available
- Automotive ordering code: base P/NHM3
- Material categorization: for definitions of compliance please see www.vishay.com/doc?99912



TYPICAL APPLICATIONS

For use in lighting, fast switching rectification of power supplies, inverters, converters, and freewheeling diodes for consumer, automotive, and telecommunication.

MECHANICAL DATA

Case: SMPC (TO-277A)

Molding compound meets UL 94 V-0 flammability rating
Base P/N-M3 - halogen-free, RoHS-compliant, and commercial grade

Base P/NHM3_X - halogen-free, RoHS-compliant and AEC-Q101 qualified

("_X" denotes revision code e.g. A, B,.....)

Terminals: matte tin plated leads, solderable per J-STD-002 and JESD 22-B102

M3 suffix meets JESD 201 class 2 whisker test, HM3 suffix meets JESD 201 class 2 whisker test

MAXIMUM RATINGS ($T_A = 25$ °C unless otherwise noted)					
PARAMETER	SYMBOL	AR4PD	AR4PG	AR4PJ	UNIT
Device marking code		AR4D	AR4G	AR4J	
Maximum repetitive peak reverse voltage	V_{RRM}	200	400	600	V
Maximum DC forward current (fig. 1)	$I_F^{(1)}$	4.0			A
	$I_F^{(2)}$	2.0			
Peak forward surge current 10 ms single half sine-wave superimposed on rated load	I_{FSM}	65			A
Non-repetitive avalanche energy at $T_J = 25$ °C	$I_{AS} = 2.5$ A max.	20			mJ
	$I_{AS} = 1.0$ A typ.	30			
Operating junction and storage temperature range	T_J, T_{STG}	-55 to +175			°C

Notes

(1) Mounted on 30 mm x 30 mm pad areas, 1 oz. FR4 PCB

(2) Free air, mounted on recommended pad area



ELECTRICAL CHARACTERISTICS ($T_A = 25\text{ }^\circ\text{C}$ unless otherwise noted)						
PARAMETER	TEST CONDITIONS	SYMBOL	TYP.	MAX.	UNIT	
Instantaneous forward voltage	$I_F = 4.0\text{ A}$	$V_F^{(1)}$	$T_A = 25\text{ }^\circ\text{C}$	1.24	1.6	V
			$T_A = 125\text{ }^\circ\text{C}$	1.02	1.20	
Reverse current	Rated V_R	$I_R^{(2)}$	$T_A = 25\text{ }^\circ\text{C}$	0.6	10	μA
			$T_A = 125\text{ }^\circ\text{C}$	60	250	
Maximum reverse recovery time	$I_F = 0.5\text{ A}$, $I_R = 1.0\text{ A}$, $I_{rr} = 0.25\text{ A}$	t_{rr}	110	140	ns	
Typical junction capacitance per diode	Rated $V_R = 4.0\text{ V}$, 1 MHz	C_J	77	-	pF	

Notes(1) Pulse test: 300 μs pulse width, 1 % duty cycle(2) Pulse test: Pulse width $\leq 40\text{ ms}$

THERMAL CHARACTERISTICS ($T_A = 25\text{ }^\circ\text{C}$ unless otherwise noted)					
PARAMETER	SYMBOL	AR4PD	AR4PG	AR4PJ	UNIT
Typical thermal resistance	$R_{\theta JA}^{(1)}$		85		$^\circ\text{C/W}$
	$R_{\theta JM}^{(2)}$		5		

Notes(1) Free air, mounted on recommended PCB 1 oz. pad are; thermal resistance $R_{\theta JA}$ - junction to ambient(2) Units mounted on PCB with 30 mm x 30 mm copper pad areas; $R_{\theta JM}$ - junction to mount

ORDERING INFORMATION (Example)				
PREFERRED P/N	UNIT WEIGHT (g)	PREFERRED PACKAGE CODE	BASE QUANTITY	DELIVERY MODE
AR4PJ-M3/86A	0.10	86A	1500	7" diameter plastic tape and reel
AR4PJ-M3/87A	0.10	87A	6500	13" diameter plastic tape and reel
AR4PJHM3_A/H ⁽¹⁾	0.10	H	1500	7" diameter plastic tape and reel
AR4PJHM3_A/I ⁽¹⁾	0.10	I	6500	13" diameter plastic tape and reel

Note

(1) AEC-Q101 qualified



RATINGS AND CHARACTERISTICS CURVES ($T_A = 25\text{ }^\circ\text{C}$ unless otherwise noted)

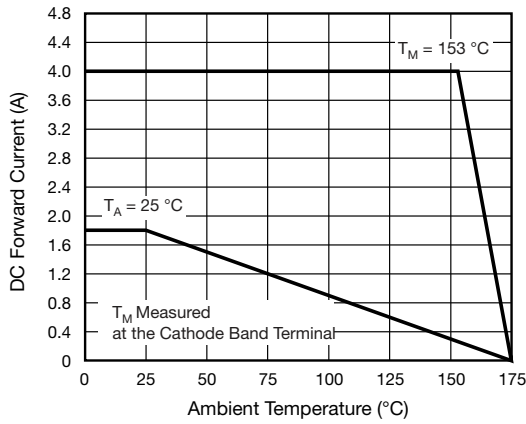

Fig. 1 - Maximum Forward Current Derating Curve

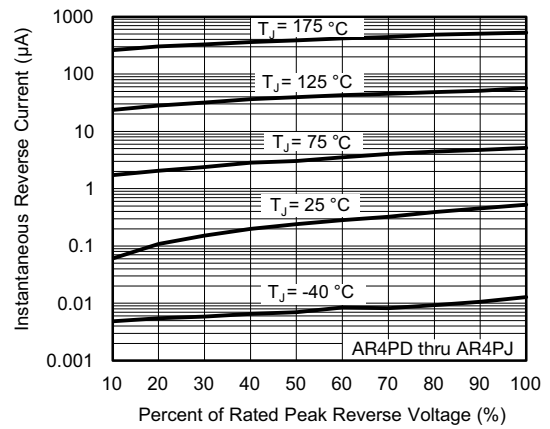

Fig. 4 - Typical Reverse Leakage Characteristics

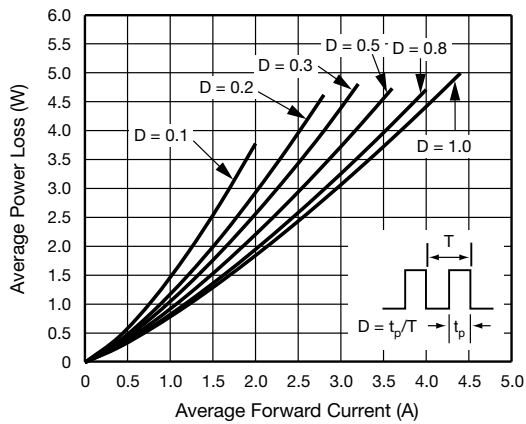

Fig. 2 - Average Power Loss Characteristics

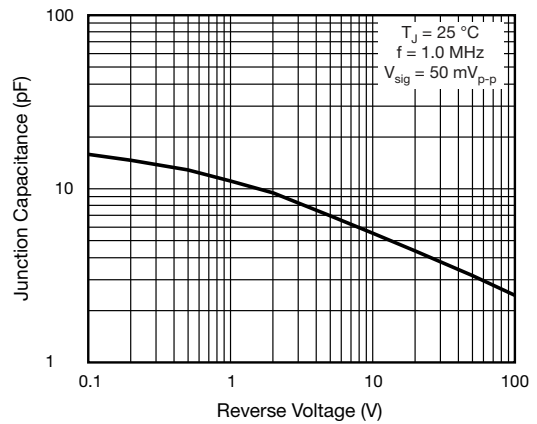

Fig. 5 - Typical Junction Capacitance

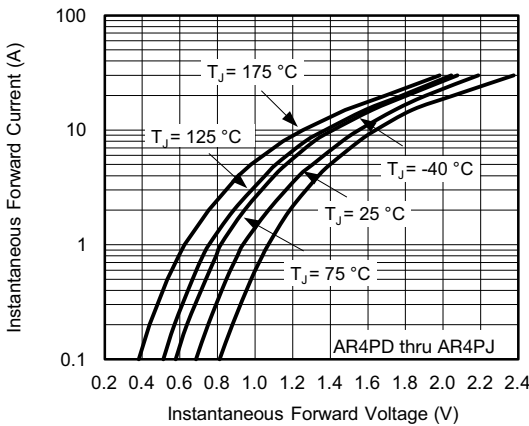

Fig. 3 - Typical Instantaneous Forward Characteristics

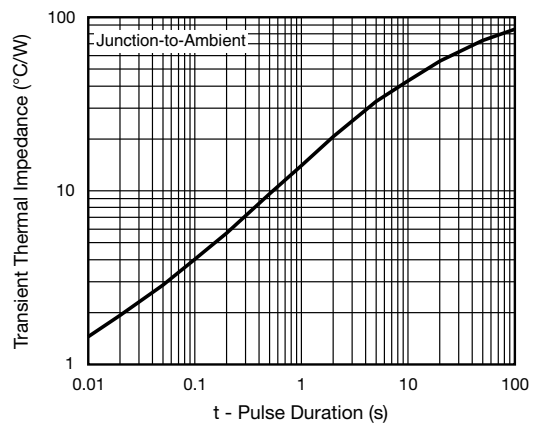
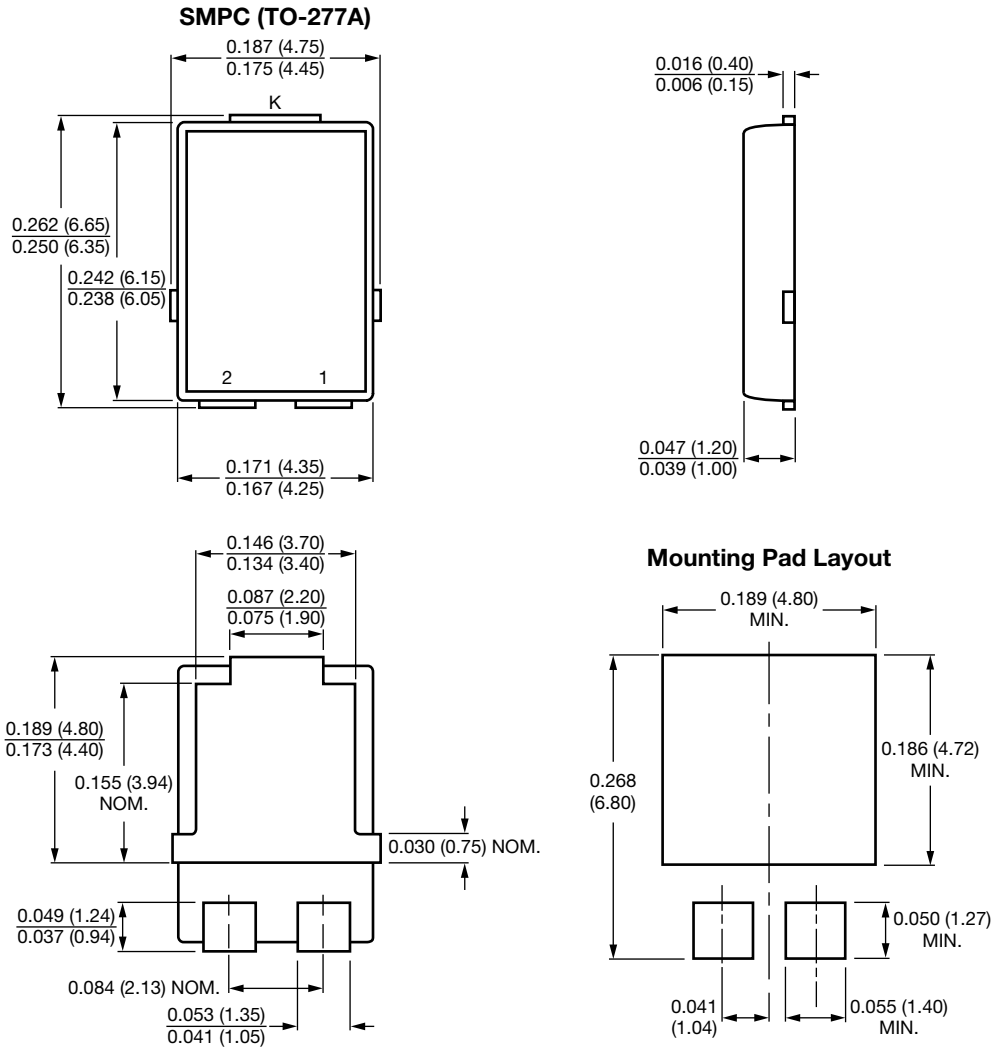

Fig. 6 - Typical Transient Thermal Impedance



PACKAGE OUTLINE DIMENSIONS in inches (millimeters)



Conform to JEDEC® TO-277A



Disclaimer

ALL PRODUCT, PRODUCT SPECIFICATIONS AND DATA ARE SUBJECT TO CHANGE WITHOUT NOTICE TO IMPROVE RELIABILITY, FUNCTION OR DESIGN OR OTHERWISE.

Vishay Intertechnology, Inc., its affiliates, agents, and employees, and all persons acting on its or their behalf (collectively, "Vishay"), disclaim any and all liability for any errors, inaccuracies or incompleteness contained in any datasheet or in any other disclosure relating to any product.

Vishay makes no warranty, representation or guarantee regarding the suitability of the products for any particular purpose or the continuing production of any product. To the maximum extent permitted by applicable law, Vishay disclaims (i) any and all liability arising out of the application or use of any product, (ii) any and all liability, including without limitation special, consequential or incidental damages, and (iii) any and all implied warranties, including warranties of fitness for particular purpose, non-infringement and merchantability.

Statements regarding the suitability of products for certain types of applications are based on Vishay's knowledge of typical requirements that are often placed on Vishay products in generic applications. Such statements are not binding statements about the suitability of products for a particular application. It is the customer's responsibility to validate that a particular product with the properties described in the product specification is suitable for use in a particular application. Parameters provided in datasheets and / or specifications may vary in different applications and performance may vary over time. All operating parameters, including typical parameters, must be validated for each customer application by the customer's technical experts. Product specifications do not expand or otherwise modify Vishay's terms and conditions of purchase, including but not limited to the warranty expressed therein.

Hyperlinks included in this datasheet may direct users to third-party websites. These links are provided as a convenience and for informational purposes only. Inclusion of these hyperlinks does not constitute an endorsement or an approval by Vishay of any of the products, services or opinions of the corporation, organization or individual associated with the third-party website. Vishay disclaims any and all liability and bears no responsibility for the accuracy, legality or content of the third-party website or for that of subsequent links.

Vishay products are not designed for use in life-saving or life-sustaining applications or any application in which the failure of the Vishay product could result in personal injury or death unless specifically qualified in writing by Vishay. Customers using or selling Vishay products not expressly indicated for use in such applications do so at their own risk. Please contact authorized Vishay personnel to obtain written terms and conditions regarding products designed for such applications.

No license, express or implied, by estoppel or otherwise, to any intellectual property rights is granted by this document or by any conduct of Vishay. Product names and markings noted herein may be trademarks of their respective owners.