

Hyperfast Soft Recovery Diode, 60 A FRED Pt® Gen 4

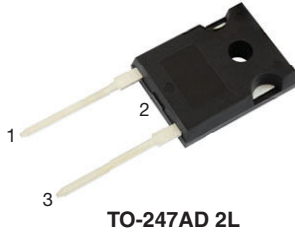

TO-247AD 2L

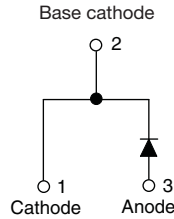

FEATURES

- Gen 4 FRED Pt® technology
- Low I_{RRM} and reverse recovery charge
- Very low forward voltage drop
- Polyimide passivated chip for high reliability standard
- 175 °C operating junction temperature
- AEC-Q101 qualified, meets JESD 201 class 1 whisker test
- Material categorization: for definitions of compliance please see www.vishay.com/doc?99912



PRODUCT SUMMARY	
Package	TO-247AD 2L
$I_{F(AV)}$	60 A
V_R	600 V
V_F at I_F	1.48 V
t_{rr} typ.	see Recovery table
T_J max.	175 °C
Diode variation	Single die

DESCRIPTION

Gen 4 Fred technology, state of the art, ultralow V_F , soft switching optimized for Discontinuous (Critical) Mode (DCM) and IGBT F/W diode.

The minimized conduction loss, optimized stored charge and low recovery current minimized the switching losses and reduce over dissipation in the switching element and snubbers.

ABSOLUTE MAXIMUM RATINGS				
PARAMETER	SYMBOL	TEST CONDITIONS	MAX.	UNITS
Cathode to anode voltage	V_R		600	V
Average rectified forward current	$I_{F(AV)}$	$T_C = 106\text{ °C}$	60	A
Single pulse forward current	I_{FSM}	$T_C = 25\text{ °C}$, $t_p = 8.3\text{ ms}$, half sine wave	425	
Operating junction and storage temperatures	T_J, T_{Stg}		-55 to +175	°C

ELECTRICAL SPECIFICATIONS ($T_J = 25\text{ °C}$ unless otherwise specified)						
PARAMETER	SYMBOL	TEST CONDITIONS	MIN.	TYP.	MAX.	UNITS
Breakdown voltage, blocking voltage	V_{BR}, V_R	$I_R = 100\ \mu\text{A}$	600	-	-	V
Forward voltage	V_F	$I_F = 50\text{ A}$	-	1.68	-	
		$I_F = 60\text{ A}$	-	1.75	2.0	
		$I_F = 50\text{ A}$, $T_J = 125\text{ °C}$	-	1.44	-	
		$I_F = 60\text{ A}$, $T_J = 125\text{ °C}$	-	1.55	-	
		$I_F = 50\text{ A}$, $T_J = 150\text{ °C}$	-	1.39	-	
Reverse leakage current	I_R	$V_R = V_R$ rated	-	-	50	μA
		$T_J = 125\text{ °C}$, $V_R = V_R$ rated	-	-	500	
Junction capacitance	C_T	$V_R = 600\text{ V}$	-	30	-	pF

DYNAMIC RECOVERY CHARACTERISTICS ($T_J = 25\text{ }^\circ\text{C}$ unless otherwise specified)							
PARAMETER	SYMBOL	TEST CONDITIONS		MIN.	TYP.	MAX.	UNITS
Reverse recovery time	t_{rr}	$T_J = 25\text{ }^\circ\text{C}$	$I_F = 60\text{ A}$ $di_F/dt = 1000\text{ A}/\mu\text{s}$ $V_R = 400\text{ V}$	-	68	-	ns
		$T_J = 125\text{ }^\circ\text{C}$		-	92	-	
Peak recovery current	I_{RRM}	$T_J = 25\text{ }^\circ\text{C}$		-	20	-	A
		$T_J = 125\text{ }^\circ\text{C}$		-	40	-	
Reverse recovery charge	Q_{rr}	$T_J = 25\text{ }^\circ\text{C}$		-	945	-	nC
		$T_J = 125\text{ }^\circ\text{C}$		-	2500	-	

THERMAL - MECHANICAL SPECIFICATIONS							
PARAMETER	SYMBOL	TEST CONDITIONS		MIN.	TYP.	MAX.	UNITS
Thermal resistance, junction to case	R_{thJC}			-	-	0.6	$^\circ\text{C}/\text{W}$
Thermal resistance, case to heat sink	R_{thCS}	Mounting surface, flat, smooth and greased		-	0.25	-	
Weight				-	6.0	-	g
				-	0.21	-	oz.
Mounting torque				6.0 (5)	-	12 (20)	kgf · cm (lbf · in)
Marking device		Case style TO-247AD 2L		E4PH6006LH			

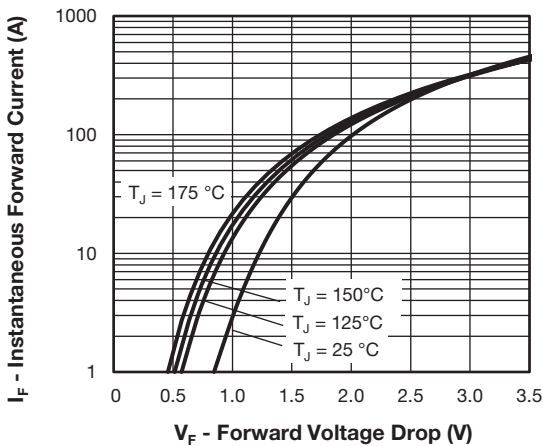

Fig. 1 - Typical Forward Voltage Drop Characteristics

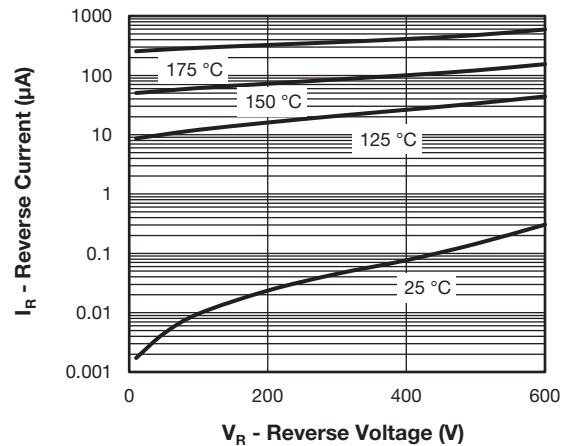

Fig. 2 - Typical Values of Reverse Current vs. Reverse Voltage

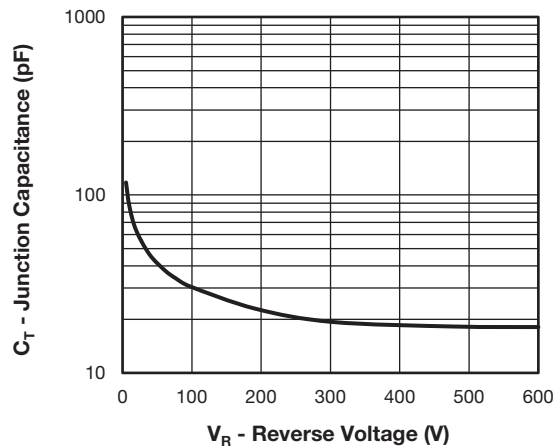

Fig. 3 - Typical Junction Capacitance vs. Reverse Voltage

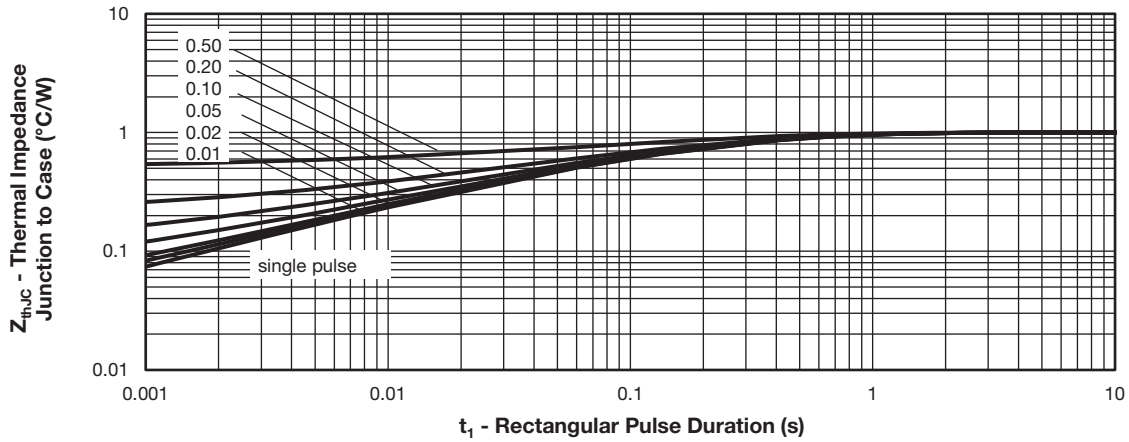

Fig. 4 - Maximum Thermal Impedance Z_{thJC} Characteristics

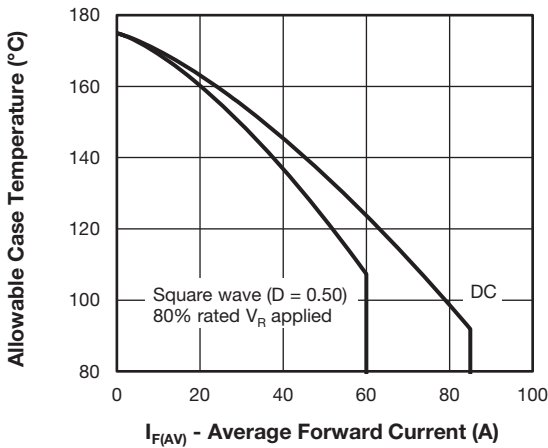

Fig. 5 - Max. Allowable Case Temperature vs. Average Forward Current

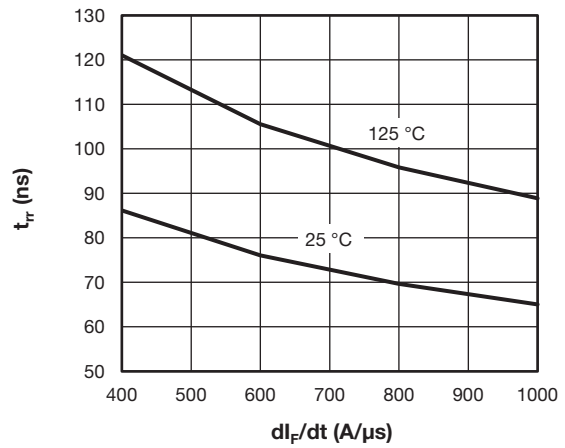

Fig. 7 - Typical Reverse Recovery Time vs. dI_F/dt

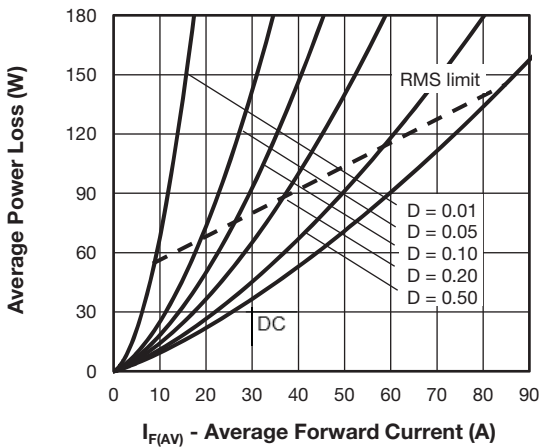

Fig. 6 - Forward Power Loss Characteristics

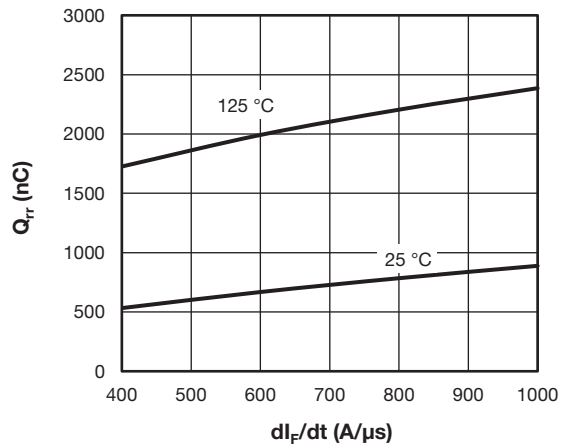

Fig. 8 - Typical Stored Charge vs. dI_F/dt

Note

- (1) Formula used: $T_C = T_J - (P_d + P_{d(REV)}) \times R_{thJC}$;
 P_d = Forward power loss = $I_{F(AV)} \times V_{FM}$ at $(I_{F(AV)}/D)$ (see Fig.5)
 $P_{d(REV)}$ = Inverse power loss = $V_{R1} \times I_R (1 - D)$; I_R at V_R = rated V_R

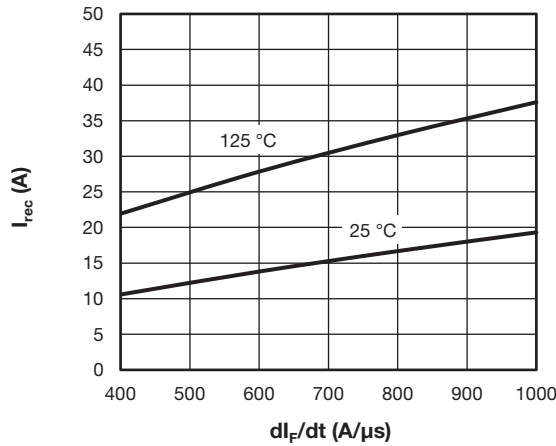

Fig. 9 - Typical Reverse Recovery vs. diF/dt

ORDERING INFORMATION TABLE

Device code	VS-	E	4	P	H	60	06	L	H	N3
	①	②	③	④	⑤	⑥	⑦	⑧	⑨	⑩

- 1** - Vishay Semiconductors product
- 2** - Circuit configuration:
E = single diode 2 pins
- 3** - FRED Gen 4
- 4** - P = TO-247 package
- 5** - Process type:
H = Hyperfast recovery
- 6** - Current rating (60 = 60 A)
- 7** - Voltage rating (06 = 600 V)
- 8** - L = long lead
- 9** - H = AEC-Q101 qualified
- 10** - Environmental digit:
N3 = halogen-free, RoHS-compliant, and totally lead (Pb)-free

ORDERING INFORMATION (Example)			
PREFERRED P/N	QUANTITY PER TUBE	MINIMUM ORDER QUANTITY	PACKAGING DESCRIPTION
VS-E4PH6006LHN3	25	500	Antistatic plastic tube

LINKS TO RELATED DOCUMENTS		
Dimensions	TO-247AD 2L	www.vishay.com/doc?95536
Part marking information	TO-247AD 2L	www.vishay.com/doc?95648

TO-247AD 2L

DIMENSIONS in millimeters and inches

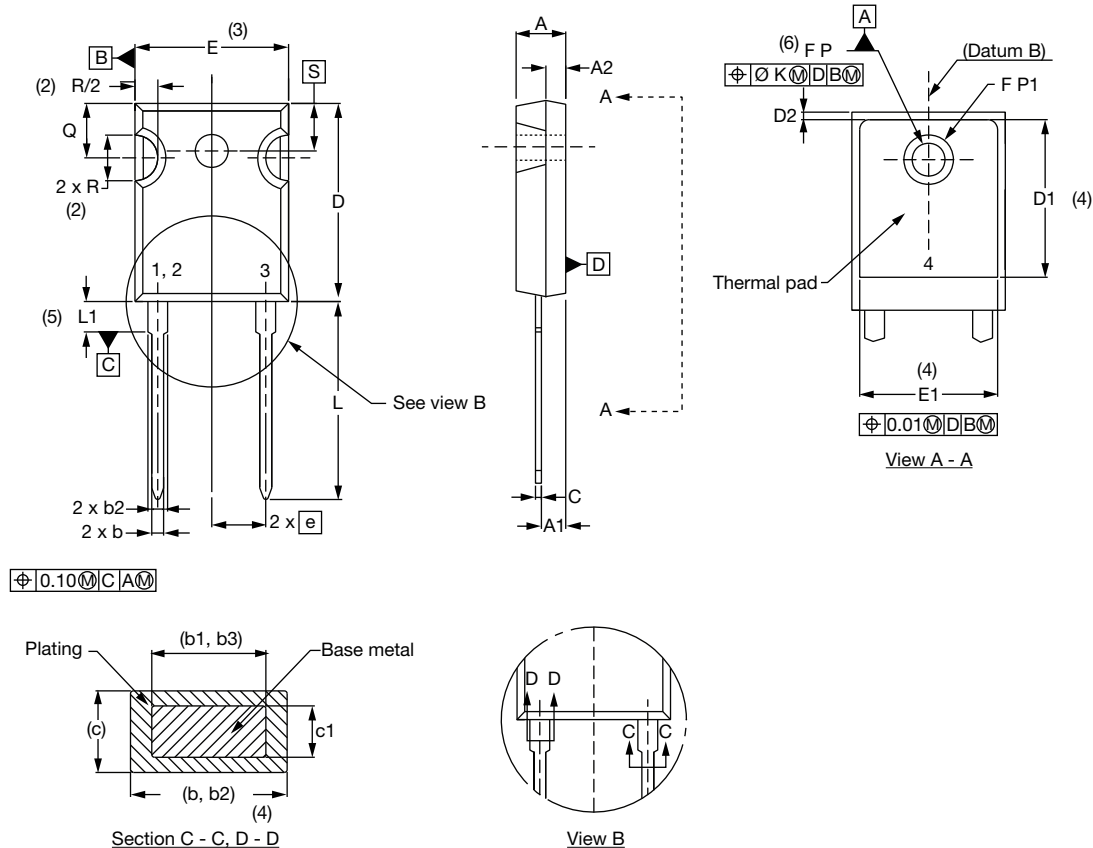

SYMBOL	MILLIMETERS		INCHES		NOTES	SYMBOL	MILLIMETERS		INCHES		NOTES
	MIN.	MAX.	MIN.	MAX.			MIN.	MAX.	MIN.	MAX.	
A	4.65	5.31	0.183	0.209		E	15.29	15.87	0.602	0.625	3
A1	2.21	2.59	0.087	0.102		E1	13.46	-	0.53	-	
A2	1.50	2.49	0.059	0.098		e	5.46 BSC		0.215 BSC		
b	0.99	1.40	0.039	0.055		$\varnothing K$	0.254		0.010		
b1	0.99	1.35	0.039	0.053		L	19.81	20.32	0.780	0.800	
b2	1.65	2.39	0.065	0.094		L1	3.71	4.29	0.146	0.169	
b3	1.65	2.34	0.065	0.092		$\varnothing P$	3.56	3.66	0.14	0.144	
c	0.38	0.89	0.015	0.035		$\varnothing P1$	-	6.98	-	0.275	
c1	0.38	0.84	0.015	0.033		Q	5.31	5.69	0.209	0.224	
D	19.71	20.70	0.776	0.815	3	R	4.52	5.49	0.178	0.216	
D1	13.08	-	0.515	-	4	S	5.51 BSC		0.217 BSC		
D2	0.51	1.35	0.020	0.053							

Notes

- (1) Dimensioning and tolerancing per ASME Y14.5M-1994
- (2) Contour of slot optional
- (3) Dimension D and E do not include mold flash. These dimensions are measured at the outermost extremes of the plastic body
- (4) Thermal pad contour optional with dimensions D1 and E1
- (5) Lead finish uncontrolled in L1
- (6) $\varnothing P$ to have a maximum draft angle of 1.5 to the top of the part with a maximum hole diameter of 3.91 mm (0.154")
- (7) Outline conforms to JEDEC® outline TO-247 with exception of dimension A min., D, E min., Q min., S, and note 4



Disclaimer

ALL PRODUCT, PRODUCT SPECIFICATIONS AND DATA ARE SUBJECT TO CHANGE WITHOUT NOTICE TO IMPROVE RELIABILITY, FUNCTION OR DESIGN OR OTHERWISE.

Vishay Intertechnology, Inc., its affiliates, agents, and employees, and all persons acting on its or their behalf (collectively, "Vishay"), disclaim any and all liability for any errors, inaccuracies or incompleteness contained in any datasheet or in any other disclosure relating to any product.

Vishay makes no warranty, representation or guarantee regarding the suitability of the products for any particular purpose or the continuing production of any product. To the maximum extent permitted by applicable law, Vishay disclaims (i) any and all liability arising out of the application or use of any product, (ii) any and all liability, including without limitation special, consequential or incidental damages, and (iii) any and all implied warranties, including warranties of fitness for particular purpose, non-infringement and merchantability.

Statements regarding the suitability of products for certain types of applications are based on Vishay's knowledge of typical requirements that are often placed on Vishay products in generic applications. Such statements are not binding statements about the suitability of products for a particular application. It is the customer's responsibility to validate that a particular product with the properties described in the product specification is suitable for use in a particular application. Parameters provided in datasheets and / or specifications may vary in different applications and performance may vary over time. All operating parameters, including typical parameters, must be validated for each customer application by the customer's technical experts. Product specifications do not expand or otherwise modify Vishay's terms and conditions of purchase, including but not limited to the warranty expressed therein.

Hyperlinks included in this datasheet may direct users to third-party websites. These links are provided as a convenience and for informational purposes only. Inclusion of these hyperlinks does not constitute an endorsement or an approval by Vishay of any of the products, services or opinions of the corporation, organization or individual associated with the third-party website. Vishay disclaims any and all liability and bears no responsibility for the accuracy, legality or content of the third-party website or for that of subsequent links.

Vishay products are not designed for use in life-saving or life-sustaining applications or any application in which the failure of the Vishay product could result in personal injury or death unless specifically qualified in writing by Vishay. Customers using or selling Vishay products not expressly indicated for use in such applications do so at their own risk. Please contact authorized Vishay personnel to obtain written terms and conditions regarding products designed for such applications.

No license, express or implied, by estoppel or otherwise, to any intellectual property rights is granted by this document or by any conduct of Vishay. Product names and markings noted herein may be trademarks of their respective owners.