

# Power Rectifier, Ultra-Fast Recovery, 2 A, 300-400 V

## MURS230, NRVUS230, NRVUS230V, MURS240, NRVUS240, NRVUS240V

Ideally suited for high voltage, high frequency rectification, or as free wheeling and protection diodes in surface mount applications where compact size and weight are critical to the system.

### Features

- Small Compact Surface Mountable Package with J-Bend Leads
- Rectangular Package for Automated Handling
- High Temperature Glass Passivated Junction
- Low Forward Voltage Drop (0.95 Volts Max @ 2.0 A, T<sub>J</sub> = 150°C)
- NRVUS and SURS8 Prefixes for Automotive and Other Applications Requiring Unique Site and Control Change Requirements; AEC-Q101 Qualified and PPAP Capable\*
- These Devices are Pb-Free and are RoHS Compliant

### Mechanical Characteristics:

- Case: Epoxy, Molded
- Weight: 95 mg (Approximately)
- Finish: All External Surfaces Corrosion Resistant and Terminal Leads are Readily Solderable
- Lead and Mounting Surface Temperature for Soldering Purposes: 260°C Max. for 10 Seconds
- Polarity: Polarity Band Indicates Cathode Lead
- ESD Rating:
  - ◆ Human Body Model = 3 A (> 4 kV)
  - ◆ Charged Device Model > 1000 V

## ULTRAFAST RECTIFIERS 2 AMPERES, 300-400 VOLTS



SMB  
CASE 403A

### MARKING DIAGRAM

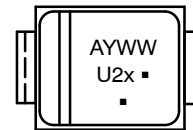

- A = Assembly Location
- Y = Year
- WW = Work Week
- U2x = Device Code
  - x = F for MURS230T3
  - = G for MURS240T3
- = Pb-Free Package

(Note: Microdot may be in either location)

### ORDERING INFORMATION

| Device  | Package       | Shipping <sup>†</sup> |
|---|---------------|-----------------------|
| MURS230T3G                                      | SMB (Pb-Free) | 2,500 / Tape & Reel   |
| NRVUS230T3G*, NRVUS230VT3G*, NRVUS230VT3G-GA01* | SMB (Pb-Free) | 2,500 / Tape & Reel   |
| MURS240T3G                                      | SMB (Pb-Free) | 2,500 / Tape & Reel   |
| NRVUS240T3G*, NRVUS240VT3G*, NRVUS240VT3G-GA01* | SMB (Pb-Free) | 2,500 / Tape & Reel   |

<sup>†</sup>For information on tape and reel specifications, including part orientation and tape sizes, please refer to our Tape and Reel Packaging Specifications Brochure, BRD8011/D.

# MURS230, NRVUS230, NRVUS230V, MURS240, NRVUS240, NRVUS240V

## MAXIMUM RATINGS

| Rating   | Symbol                          | Value       | Unit             |
|--|---------------------------------|-------------|------------------|
| Peak Repetitive Reverse Voltage<br>Working Peak Reverse Voltage<br>DC Blocking Voltage<br>MURS230T3G/NRVUS230T3G/NRVUS230VT3G-GA01<br>MURS240T3G/NRVUS240T3G/NRVUS240VT3G-GA01 | $V_{RRM}$<br>$V_{RWM}$<br>$V_R$ | 300<br>400  | V                |
| Average Rectified Forward Current<br>@ $T_L = 150^\circ\text{C}$<br>@ $T_L = 125^\circ\text{C}$  | $I_{F(AV)}$                     | 1.0<br>2.0  | A                |
| Non-Repetitive Peak Surge Current<br>(Surge applied at rated load conditions halfwave, single phase, 60 Hz)  | $I_{FSM}$                       | 35          | A                |
| Operating Junction and Storage Temperature Range   | $T_J, T_{STG}$                  | -65 to +175 | $^\circ\text{C}$ |

Stresses exceeding those listed in the Maximum Ratings table may damage the device. If any of these limits are exceeded, device functionality should not be assumed, damage may occur and reliability may be affected.

## THERMAL CHARACTERISTICS

| Rating  | Symbol          | Max | Unit                      |
|---|-----------------|-----|---------------------------|
| Thermal Resistance, Junction-to-Lead ( $T_L = 25^\circ\text{C}$ ) | $R_{\theta JL}$ | 13  | $^\circ\text{C}/\text{W}$ |

## ELECTRICAL CHARACTERISTICS

| Characteristic  | Symbol   | Value        | Unit          |
|---|----------|--------------|---------------|
| Maximum Instantaneous Forward Voltage (Note 1)<br>( $i_F = 2.0\text{ A}$ , $T_J = 25^\circ\text{C}$ )<br>( $i_F = 2.0\text{ A}$ , $T_J = 150^\circ\text{C}$ )     | $V_F$    | 1.30<br>1.05 | V             |
| Maximum Instantaneous Reverse Current (Note 1)<br>(Rated DC Voltage, $T_J = 25^\circ\text{C}$ )<br>(Rated DC Voltage, $T_J = 150^\circ\text{C}$ )                 | $i_R$    | 5.0<br>150   | $\mu\text{A}$ |
| Maximum Reverse Recovery Time<br>( $i_F = 1.0\text{ A}$ , $di/dt = 50\text{ A}/\mu\text{s}$ )<br>( $i_F = 0.5\text{ A}$ , $i_R = 1.0\text{ A}$ , $I_R$ to 0.25 A) | $t_{rr}$ | 65<br>50     | ns            |
| Maximum Forward Recovery Time<br>( $i_F = 1.0\text{ A}$ , $di/dt = 100\text{ A}/\mu\text{s}$ , Rec. to 1.0 V)   | $t_{fr}$ | 50           | ns            |

Product parametric performance is indicated in the Electrical Characteristics for the listed test conditions, unless otherwise noted. Product performance may not be indicated by the Electrical Characteristics if operated under different conditions.

1. Pulse Test: Pulse Width = 300  $\mu\text{s}$ , Duty Cycle  $\leq 2.0\%$ .

MURS230, NRVUS230, NRVUS230V, MURS240, NRVUS240, NRVUS240V

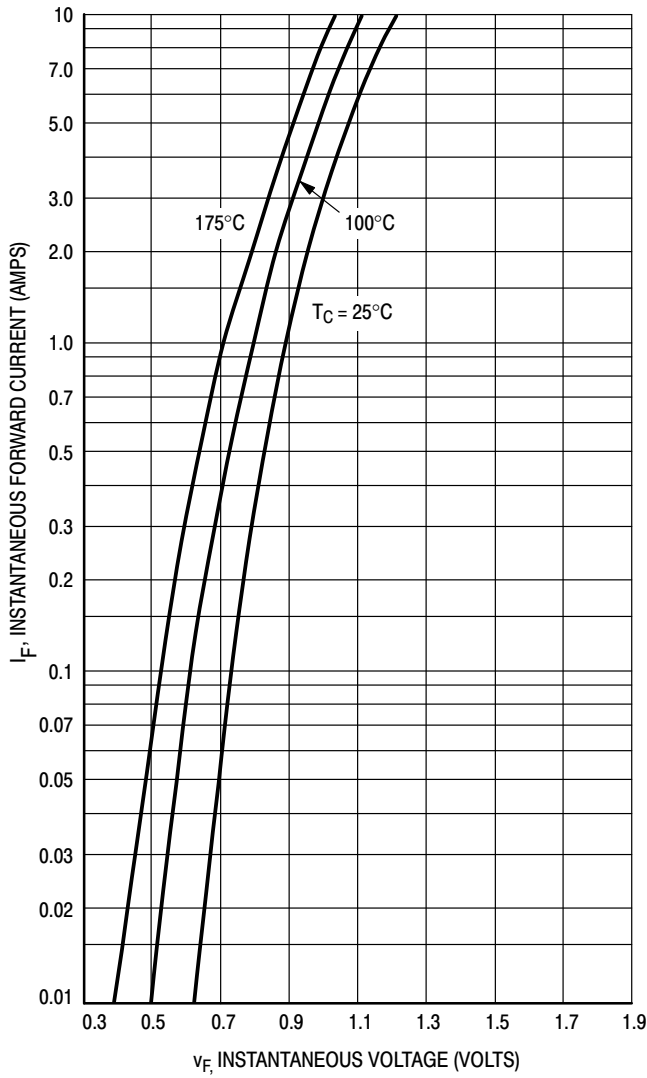

Figure 1. Typical Forward Voltage

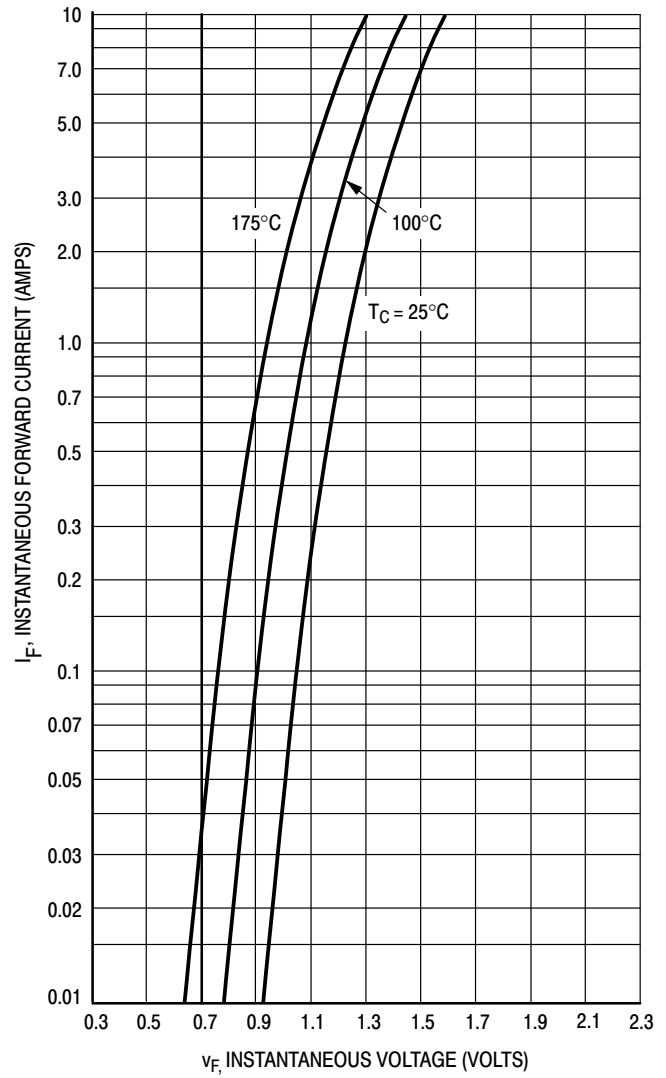

Figure 2. Maximum Forward Voltage

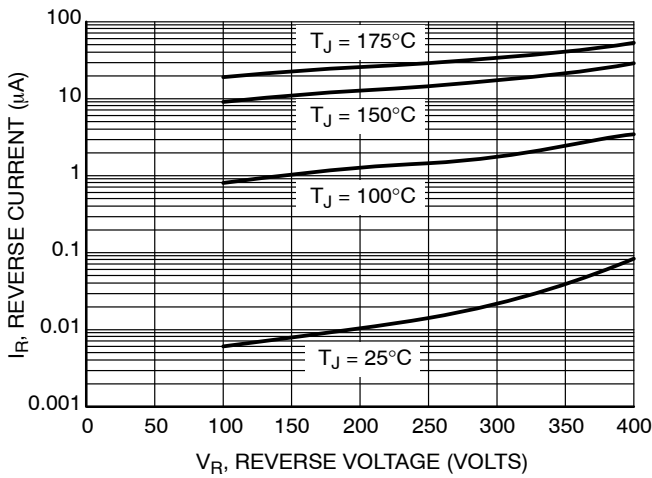

Figure 3. Typical Reverse Current\*

\* The curves shown are typical for the highest voltage device in the voltage grouping. Typical reverse current for lower voltage selections can be estimated from these same curves if applied  $V_R$  is sufficiently below rated  $V_R$ .

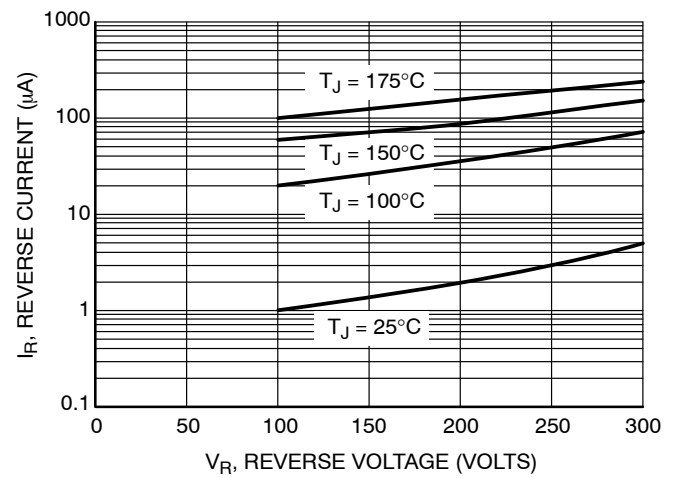

Figure 4. Maximum Reverse Current for MURS230T3G, NRVUS230T3G

MURS230, NRVUS230, NRVUS230V, MURS240, NRVUS240, NRVUS240V

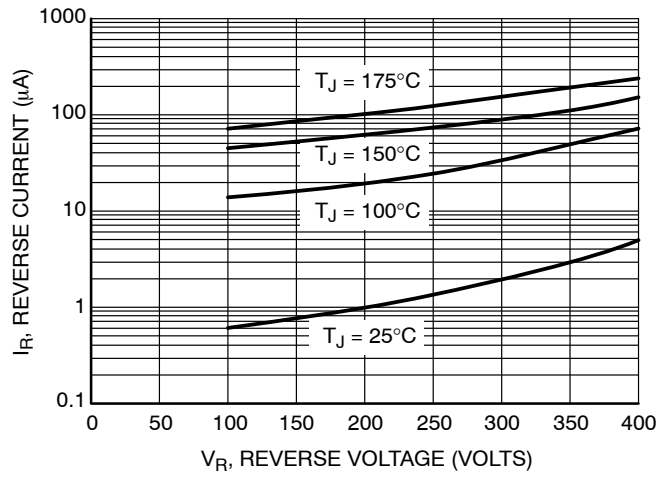

Figure 5. Maximum Reverse Current for MURS240T3G, NRVUS240T3G

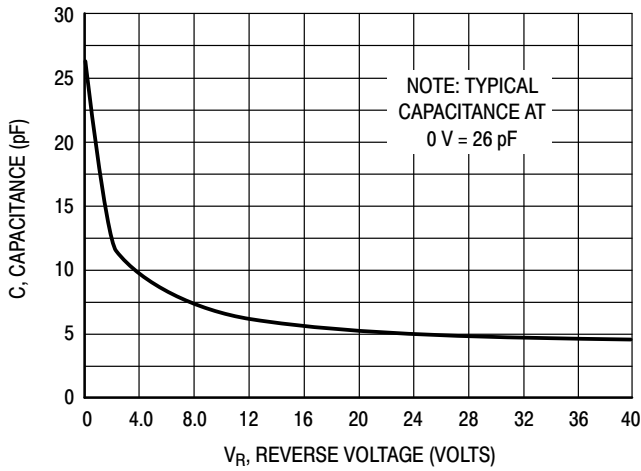

Figure 6. Typical Capacitance

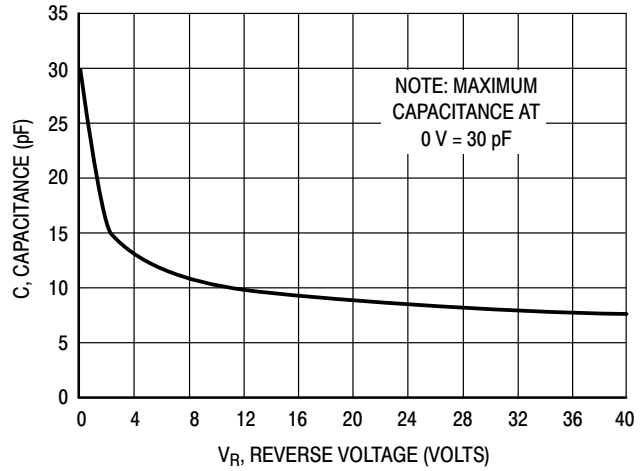

Figure 7. Maximum Capacitance

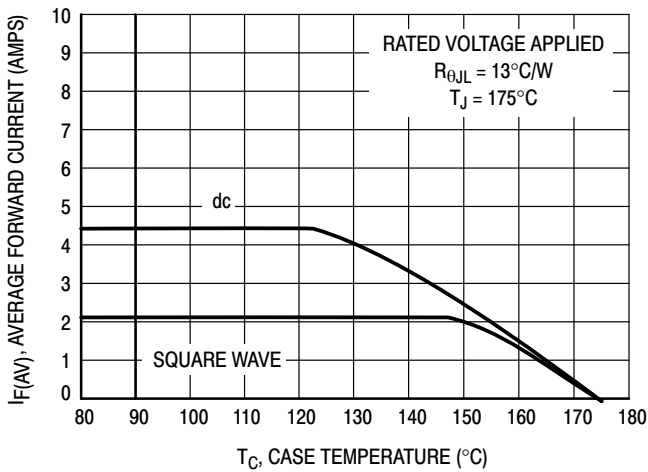

Figure 8. Current Derating, Case

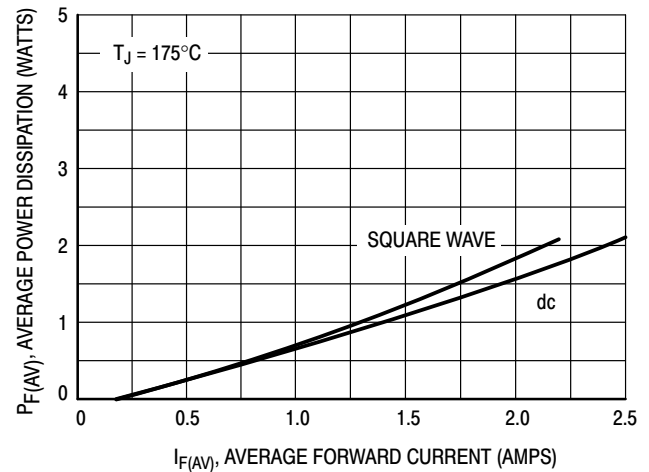

Figure 9. Power Dissipation



SCALE 1:1

Polarity Band



SCALE 1:1

Non-Polarity Band

SMB  
CASE 403A-03  
ISSUE J

DATE 19 JUL 2012

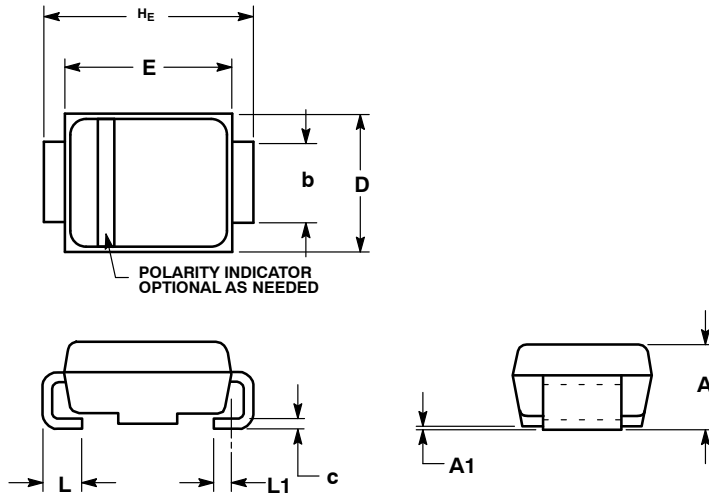

POLARITY INDICATOR  
OPTIONAL AS NEEDED

SOLDERING FOOTPRINT\*

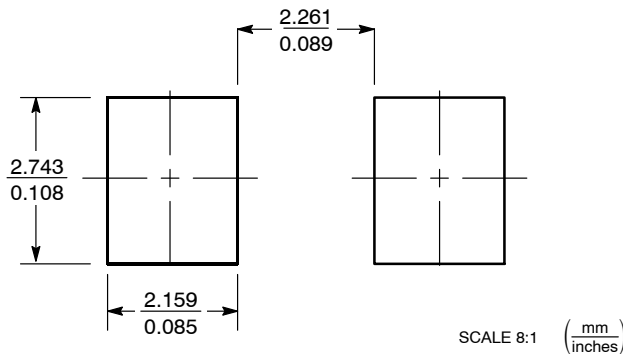

- NOTES:
1. DIMENSIONING AND TOLERANCING PER ANSI Y14.5M, 1982.
  2. CONTROLLING DIMENSION: INCH.
  3. DIMENSION b SHALL BE MEASURED WITHIN DIMENSION L1.

| DIM | MILLIMETERS |      |      | INCHES    |       |       |
|-----|-------------|------|------|-----------|-------|-------|
|     | MIN         | NOM  | MAX  | MIN       | NOM   | MAX   |
| A   | 1.95        | 2.30 | 2.47 | 0.077     | 0.091 | 0.097 |
| A1  | 0.05        | 0.10 | 0.20 | 0.002     | 0.004 | 0.008 |
| b   | 1.96        | 2.03 | 2.20 | 0.077     | 0.080 | 0.087 |
| c   | 0.15        | 0.23 | 0.31 | 0.006     | 0.009 | 0.012 |
| D   | 3.30        | 3.56 | 3.95 | 0.130     | 0.140 | 0.156 |
| E   | 4.06        | 4.32 | 4.60 | 0.160     | 0.170 | 0.181 |
| HE  | 5.21        | 5.44 | 5.60 | 0.205     | 0.214 | 0.220 |
| L   | 0.76        | 1.02 | 1.60 | 0.030     | 0.040 | 0.063 |
| L1  | 0.51 REF    |      |      | 0.020 REF |       |       |

GENERIC  
MARKING DIAGRAM\*

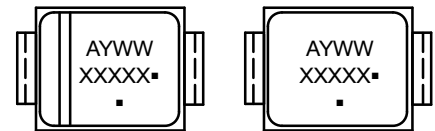

Polarity Band

Non-Polarity Band

- XXXXX = Specific Device Code
- A = Assembly Location
- Y = Year
- WW = Work Week
- = Pb-Free Package

(Note: Microdot may be in either location)

\*This information is generic. Please refer to device data sheet for actual part marking. Pb-Free indicator, "G" or microdot "▪", may or may not be present. Some products may not follow the Generic Marking.

\*For additional information on our Pb-Free strategy and soldering details, please download the onsemi Soldering and Mounting Techniques Reference Manual, SOLDERM/D.

|                  |             |   |
|------------------|-------------|---|
| DOCUMENT NUMBER: | 98ASB42669B | Electronic versions are uncontrolled except when accessed directly from the Document Repository.<br>Printed versions are uncontrolled except when stamped "CONTROLLED COPY" in red. |
| DESCRIPTION:     | SMB         | PAGE 1 OF 1   |

onsemi and ONSEMI are trademarks of Semiconductor Components Industries, LLC dba onsemi or its subsidiaries in the United States and/or other countries. onsemi reserves the right to make changes without further notice to any products herein. onsemi makes no warranty, representation or guarantee regarding the suitability of its products for any particular purpose, nor does onsemi assume any liability arising out of the application or use of any product or circuit, and specifically disclaims any and all liability, including without limitation special, consequential or incidental damages. onsemi does not convey any license under its patent rights nor the rights of others.

**onsemi**, **Onsemi**, and other names, marks, and brands are registered and/or common law trademarks of Semiconductor Components Industries, LLC dba "**onsemi**" or its affiliates and/or subsidiaries in the United States and/or other countries. **onsemi** owns the rights to a number of patents, trademarks, copyrights, trade secrets, and other intellectual property. A listing of **onsemi**'s product/patent coverage may be accessed at [www.onsemi.com/site/pdf/Patent-Marking.pdf](http://www.onsemi.com/site/pdf/Patent-Marking.pdf). **onsemi** reserves the right to make changes at any time to any products or information herein, without notice. The information herein is provided "as-is" and **onsemi** makes no warranty, representation or guarantee regarding the accuracy of the information, product features, availability, functionality, or suitability of its products for any particular purpose, nor does **onsemi** assume any liability arising out of the application or use of any product or circuit, and specifically disclaims any and all liability, including without limitation special, consequential or incidental damages. Buyer is responsible for its products and applications using **onsemi** products, including compliance with all laws, regulations and safety requirements or standards, regardless of any support or applications information provided by **onsemi**. "Typical" parameters which may be provided in **onsemi** data sheets and/or specifications can and do vary in different applications and actual performance may vary over time. All operating parameters, including "Typicals" must be validated for each customer application by customer's technical experts. **onsemi** does not convey any license under any of its intellectual property rights nor the rights of others. **onsemi** products are not designed, intended, or authorized for use as a critical component in life support systems or any FDA Class 3 medical devices or medical devices with a same or similar classification in a foreign jurisdiction or any devices intended for implantation in the human body. Should Buyer purchase or use **onsemi** products for any such unintended or unauthorized application, Buyer shall indemnify and hold **onsemi** and its officers, employees, subsidiaries, affiliates, and distributors harmless against all claims, costs, damages, and expenses, and reasonable attorney fees arising out of, directly or indirectly, any claim of personal injury or death associated with such unintended or unauthorized use, even if such claim alleges that **onsemi** was negligent regarding the design or manufacture of the part. **onsemi** is an Equal Opportunity/Affirmative Action Employer. This literature is subject to all applicable copyright laws and is not for resale in any manner.

## ADDITIONAL INFORMATION

### TECHNICAL PUBLICATIONS:

Technical Library: [www.onsemi.com/design/resources/technical-documentation](http://www.onsemi.com/design/resources/technical-documentation)  
onsemi Website: [www.onsemi.com](http://www.onsemi.com)

### ONLINE SUPPORT: [www.onsemi.com/support](http://www.onsemi.com/support)

For additional information, please contact your local Sales Representative at [www.onsemi.com/support/sales](http://www.onsemi.com/support/sales)