

# High Voltage Switching Diode

## BAS19L, BAS20L, BAS21L, BAS21DW5

### Features

- These Devices are Pb-Free, Halogen Free/BFR Free and are RoHS Compliant
- S and NSV Prefixes for Automotive and Other Applications Requiring Unique Site and Control Change Requirements; AEC-Q101 Qualified and PPAP Capable

### MAXIMUM RATINGS

Rating	Symbol	Value	Unit
Continuous Reverse Voltage	$V_R$	120 200 250	Vdc
Repetitive Peak Reverse Voltage	$V_{RRM}$	120 200 250	Vdc
Continuous Forward Current	$I_F$	200	mAdc
Peak Forward Surge Current (1/2 Cycle, Sine Wave, 60 Hz)	$I_{FSM}$	2	A
Repetitive Peak Forward Current (Pulse Train: $T_{ON} = 1$ s, $T_{OFF} = 0.5$ s)	$I_{FRM}$	0.6	A
Junction and Storage Temperature Range	$T_J, T_{stg}$	-55 to +150	°C
Power Dissipation (Note 1)	$P_D$	385	mW
Electrostatic Discharge	ESD	HM < 500 MM < 400	V V

Stresses exceeding those listed in the Maximum Ratings table may damage the device. If any of these limits are exceeded, device functionality should not be assumed, damage may occur and reliability may be affected.

1. Mounted on FR-5 Board = 1.0 x 0.75 x 0.062 in.

## HIGH VOLTAGE SWITCHING DIODE

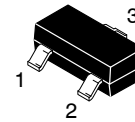
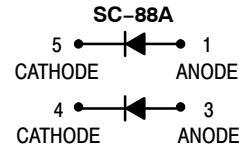
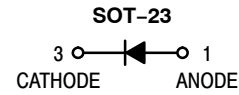

SOT-23 (TO-236)  
CASE 318  
STYLE 8



SC-88A (SOT-353)  
CASE 419A

### MARKING DIAGRAMS

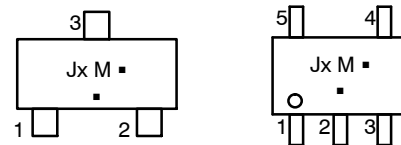

- x = P, R, or S
- P = BAS19L
- R = BAS20L
- S = BAS21L or BAS21DW5
- M = Date Code
- = Pb-Free Package

(Note: Microdot may be in either location)

\*Date Code orientation and/or overbar may vary depending upon the manufacturing location.

### ORDERING INFORMATION

See detailed ordering and shipping information in the package dimensions section on page 4 of this data sheet.

# BAS19L, BAS20L, BAS21L, BAS21DW5

## Thermal Characteristics (SOT-23)

Characteristic	Symbol	Max	Unit
Total Device Dissipation FR-5 Board (Note 2) $T_A = 25^\circ\text{C}$ Derate above $25^\circ\text{C}$	$P_D$	225	mW
		1.8	mW/ $^\circ\text{C}$
Thermal Resistance Junction-to-Ambient (SOT-23)	$R_{\theta JA}$	556	$^\circ\text{C}/\text{W}$
Total Device Dissipation Alumina Substrate (Note 3) $T_A = 25^\circ\text{C}$ Derate above $25^\circ\text{C}$	$P_D$	300	mW
		2.4	mW/ $^\circ\text{C}$
Thermal Resistance Junction-to-Ambient	$R_{\theta JA}$	417	$^\circ\text{C}/\text{W}$
Junction and Storage Temperature Range	$T_J, T_{stg}$	-55 to +150	$^\circ\text{C}$

## Thermal Characteristics (SC-88A)

Characteristic	Symbol	Max	Unit
Power Dissipation (Note 4)	$P_D$	385	mW
Thermal Resistance - Junction-to-Ambient Derate Above $25^\circ\text{C}$	$R_{\theta JA}$	328	$^\circ\text{C}/\text{W}$
		3.0	mW/ $^\circ\text{C}$
Maximum Junction Temperature	$T_{Jmax}$	150	$^\circ\text{C}$
Operating Junction and Storage Temperature Range	$T_J, T_{stg}$	-55 to +150	$^\circ\text{C}$

2. FR-5 = 1.0 × 0.75 × 0.062 in.

3. Alumina = 0.4 × 0.3 × 0.024 in. 99.5% alumina.

4. Mounted on FR-5 Board = 1.0 × 0.75 × 0.062 in.

## Electrical Characteristics ( $T_A = 25^\circ\text{C}$ unless otherwise noted)

Characteristic	Symbol	Min	Max	Unit	
Reverse Voltage Leakage Current ( $V_R = 100$ Vdc) ( $V_R = 150$ Vdc) ( $V_R = 200$ Vdc) ( $V_R = 100$ Vdc, $T_J = 150^\circ\text{C}$ ) ( $V_R = 150$ Vdc, $T_J = 150^\circ\text{C}$ ) ( $V_R = 200$ Vdc, $T_J = 150^\circ\text{C}$ )	$I_R$	-	BAS19	0.1	$\mu\text{A}_{dc}$
			BAS20	0.1	
			BAS21	0.1	
			BAS19	100	
			BAS20	100	
			BAS21	100	
Reverse Breakdown Voltage ( $I_{BR} = 100$ $\mu\text{A}_{dc}$ ) ( $I_{BR} = 100$ $\mu\text{A}_{dc}$ ) ( $I_{BR} = 100$ $\mu\text{A}_{dc}$ )	$V_{(BR)}$	-	BAS19	120	Vdc
			BAS20	200	
			BAS21	250	
Forward Voltage ( $I_F = 100$ mA $_{dc}$ ) ( $I_F = 200$ mA $_{dc}$ )	$V_F$	-		1.0	Vdc
				1.25	
Diode Capacitance ( $V_R = 0$ , $f = 1.0$ MHz)	$C_D$	-	5.0	pF	
Reverse Recovery Time ( $I_F = I_R = 30$ mA $_{dc}$ , $I_{R(REC)} = 3.0$ mA $_{dc}$ , $R_L = 100$ )	$t_{rr}$	-	50	ns	

Product parametric performance is indicated in the Electrical Characteristics for the listed test conditions, unless otherwise noted. Product performance may not be indicated by the Electrical Characteristics if operated under different conditions.

# BAS19L, BAS20L, BAS21L, BAS21DW5

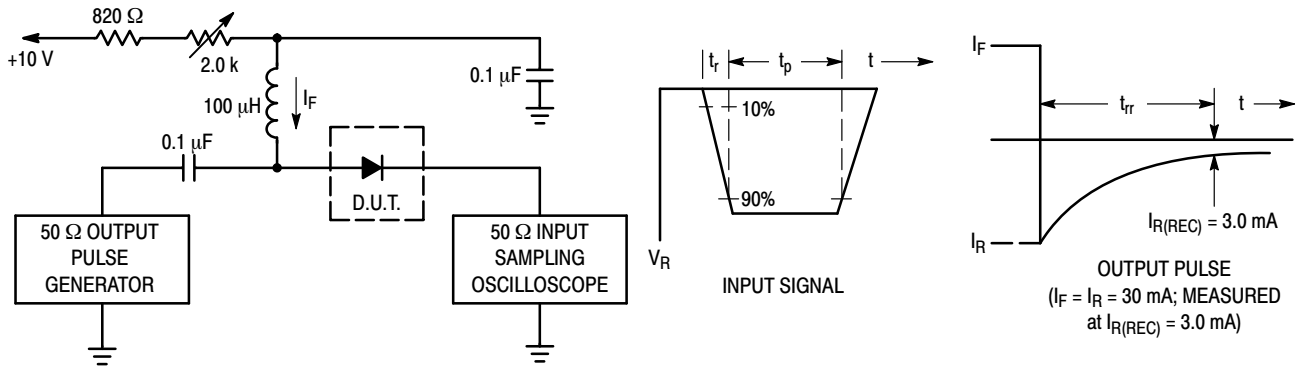

- Notes: 1. A 2.0 kΩ variable resistor adjusted for a Forward Current ( $I_F$ ) of 30 mA.  
 2. Input pulse is adjusted so  $I_{R(peak)}$  is equal to 30 mA.  
 3.  $t_p \gg t_{rr}$

Figure 1. Recovery Time Equivalent Test Circuit

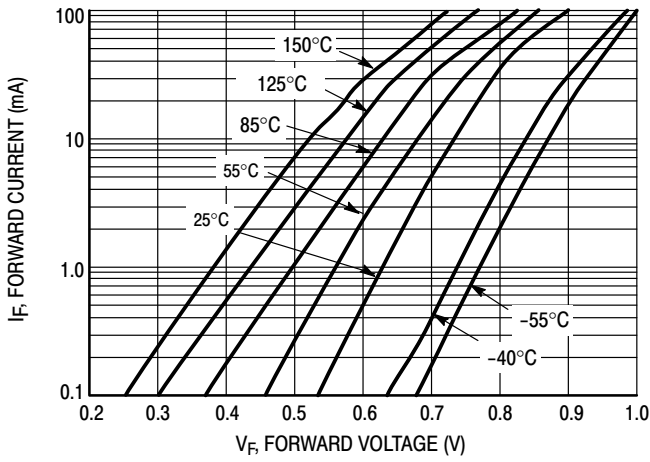

Figure 2.  $V_F$  vs.  $I_F$

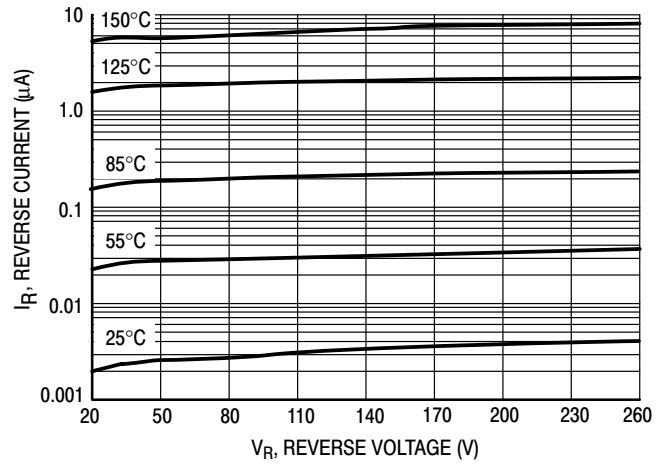

Figure 3.  $I_R$  vs.  $V_R$

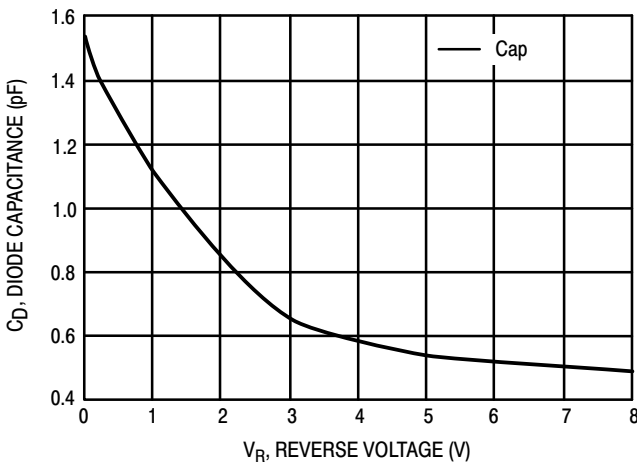

Figure 4. Capacitance

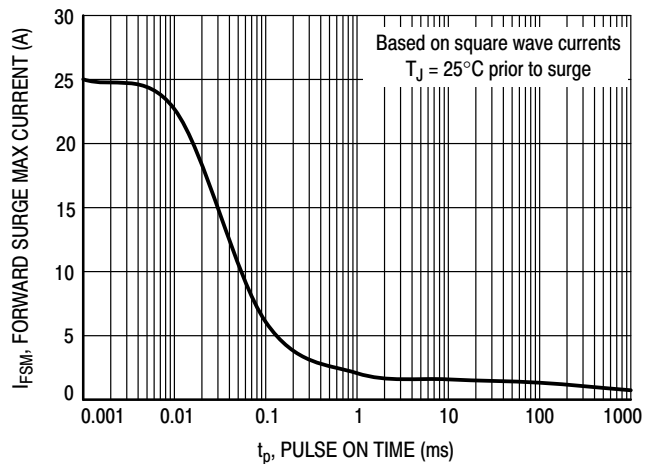

Figure 5. Forward Surge Current

## BAS19L, BAS20L, BAS21L, BAS21DW5

### ORDERING INFORMATION

Device	Package	Shipping <sup>†</sup>
BAS19LT1G	SOT-23 (Pb-Free)	3000 / Tape & Reel
BAS19LT3G	SOT-23 (Pb-Free)	10000 / Tape & Reel
NSVBAS19LT1G*	SOT-23 (Pb-Free)	3000 / Tape & Reel
BAS20LT1G	SOT-23 (Pb-Free)	3000 / Tape & Reel
BAS20LT3G	SOT-23 (Pb-Free)	10000 / Tape & Reel
NSVBAS20LT3G*	SOT-23 (Pb-Free)	10000 / Tape & Reel
SBAS20LT1G*	SOT-23 (Pb-Free)	3000 / Tape & Reel
BAS21LT1G	SOT-23 (Pb-Free)	3000 / Tape & Reel
SBAS21LT1G*	SOT-23 (Pb-Free)	3000 / Tape & Reel
BAS21LT3G	SOT-23 (Pb-Free)	10000 / Tape & Reel
SBAS21LT3G*	SOT-23 (Pb-Free)	10000 / Tape & Reel
BAS21DW5T1G	SC-88A (Pb-Free)	3000 / Tape & Reel
SBAS21DW5T1G*	SC-88A (Pb-Free)	3000 / Tape & Reel
SBAS21DW5T3G*	SC-88A (Pb-Free)	10000 / Tape & Reel

<sup>†</sup>For information on tape and reel specifications, including part orientation and tape sizes, please refer to our Tape and Reel Packaging Specifications Brochure, BRD8011/D.

\*S and NSV Prefixes for Automotive and Other Applications Requiring Unique Site and Control Change Requirements; AEC-Q101 Qualified and PPAP Capable.



SCALE 2:1

SC-88A (SC-70-5/SOT-353)  
CASE 419A-02  
ISSUE M

DATE 11 APR 2023

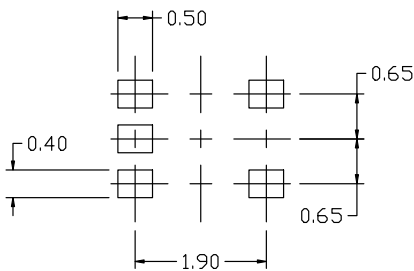
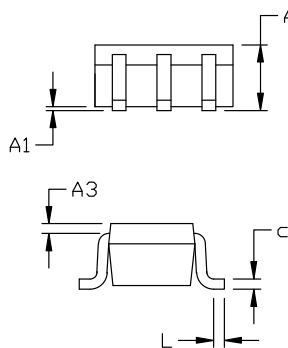
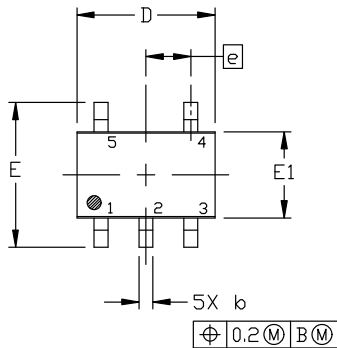

RECOMMENDED MOUNTING FOOTPRINT

\* For additional information on our Pb-Free strategy and soldering details, please download the ON Semiconductor Soldering and Mounting Techniques Reference Manual, SOLDERM/D.

NOTES:

1. DIMENSIONING AND TOLERANCING PER ANSI Y14.5M, 1982.
2. CONTROLLING DIMENSION: MILLIMETERS
3. 419A-01 OBSOLETE. NEW STANDARD 419A-02
4. DIMENSIONS D AND E1 DO NOT INCLUDE MOLD FLASH, PROTRUSIONS, OR GATE BURRS. MOLD FLASH, PROTRUSIONS, OR GATE BURRS SHALL NOT EXCEED 0.1016MM PER SIDE.

DIM	MILLIMETERS		
	MIN.	NOM.	MAX.
A	0.80	0.95	1.10
A1	---	---	0.10
A3	0.20 REF		
b	0.10	0.20	0.30
c	0.10	---	0.25
D	1.80	2.00	2.20
E	2.00	2.10	2.20
E1	1.15	1.25	1.35
e	0.65 BSC		
L	0.10	0.15	0.30

GENERIC MARKING DIAGRAM\*

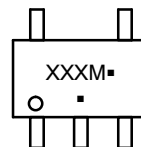

\*This information is generic. Please refer to device data sheet for actual part marking. Pb-Free indicator, "G" or microdot "▪", may or may not be present. Some products may not follow the Generic Marking.

XXX = Specific Device Code  
M = Date Code  
▪ = Pb-Free Package

(Note: Microdot may be in either location)

STYLE 1:

- PIN 1. BASE
- 2. EMITTER
- 3. BASE
- 4. COLLECTOR
- 5. COLLECTOR

STYLE 2:

- PIN 1. ANODE
- 2. EMITTER
- 3. BASE
- 4. COLLECTOR
- 5. CATHODE

STYLE 3:

- PIN 1. ANODE 1
- 2. N/C
- 3. ANODE 2
- 4. CATHODE 2
- 5. CATHODE 1

STYLE 4:

- PIN 1. SOURCE 1
- 2. DRAIN 1/2
- 3. SOURCE 1
- 4. GATE 1
- 5. GATE 2

STYLE 5:

- PIN 1. CATHODE
- 2. COMMON ANODE
- 3. CATHODE 2
- 4. CATHODE 3
- 5. CATHODE 4

STYLE 6:

- PIN 1. EMITTER 2
- 2. BASE 2
- 3. EMITTER 1
- 4. COLLECTOR
- 5. COLLECTOR 2/BASE 1

STYLE 7:

- PIN 1. BASE
- 2. EMITTER
- 3. BASE
- 4. COLLECTOR
- 5. COLLECTOR

STYLE 8:

- PIN 1. CATHODE
- 2. COLLECTOR
- 3. N/C
- 4. BASE
- 5. EMITTER

STYLE 9:

- PIN 1. ANODE
- 2. CATHODE
- 3. ANODE
- 4. ANODE
- 5. ANODE

Note: Please refer to datasheet for style callout. If style type is not called out in the datasheet refer to the device datasheet pinout or pin assignment.

DOCUMENT NUMBER:	98ASB42984B	Electronic versions are uncontrolled except when accessed directly from the Document Repository. Printed versions are uncontrolled except when stamped "CONTROLLED COPY" in red.
DESCRIPTION:	SC-88A (SC-70-5/SOT-353)	PAGE 1 OF 1

onsemi and onsemi are trademarks of Semiconductor Components Industries, LLC dba onsemi or its subsidiaries in the United States and/or other countries. onsemi reserves the right to make changes without further notice to any products herein. onsemi makes no warranty, representation or guarantee regarding the suitability of its products for any particular purpose, nor does onsemi assume any liability arising out of the application or use of any product or circuit, and specifically disclaims any and all liability, including without limitation special, consequential or incidental damages. onsemi does not convey any license under its patent rights nor the rights of others.

**onsemi**, **Onsemi**, and other names, marks, and brands are registered and/or common law trademarks of Semiconductor Components Industries, LLC dba "**onsemi**" or its affiliates and/or subsidiaries in the United States and/or other countries. **onsemi** owns the rights to a number of patents, trademarks, copyrights, trade secrets, and other intellectual property. A listing of **onsemi**'s product/patent coverage may be accessed at [www.onsemi.com/site/pdf/Patent-Marking.pdf](http://www.onsemi.com/site/pdf/Patent-Marking.pdf). **onsemi** reserves the right to make changes at any time to any products or information herein, without notice. The information herein is provided "as-is" and **onsemi** makes no warranty, representation or guarantee regarding the accuracy of the information, product features, availability, functionality, or suitability of its products for any particular purpose, nor does **onsemi** assume any liability arising out of the application or use of any product or circuit, and specifically disclaims any and all liability, including without limitation special, consequential or incidental damages. Buyer is responsible for its products and applications using **onsemi** products, including compliance with all laws, regulations and safety requirements or standards, regardless of any support or applications information provided by **onsemi**. "Typical" parameters which may be provided in **onsemi** data sheets and/or specifications can and do vary in different applications and actual performance may vary over time. All operating parameters, including "Typicals" must be validated for each customer application by customer's technical experts. **onsemi** does not convey any license under any of its intellectual property rights nor the rights of others. **onsemi** products are not designed, intended, or authorized for use as a critical component in life support systems or any FDA Class 3 medical devices or medical devices with a same or similar classification in a foreign jurisdiction or any devices intended for implantation in the human body. Should Buyer purchase or use **onsemi** products for any such unintended or unauthorized application, Buyer shall indemnify and hold **onsemi** and its officers, employees, subsidiaries, affiliates, and distributors harmless against all claims, costs, damages, and expenses, and reasonable attorney fees arising out of, directly or indirectly, any claim of personal injury or death associated with such unintended or unauthorized use, even if such claim alleges that **onsemi** was negligent regarding the design or manufacture of the part. **onsemi** is an Equal Opportunity/Affirmative Action Employer. This literature is subject to all applicable copyright laws and is not for resale in any manner.

## ADDITIONAL INFORMATION

### TECHNICAL PUBLICATIONS:

Technical Library: [www.onsemi.com/design/resources/technical-documentation](http://www.onsemi.com/design/resources/technical-documentation)  
onsemi Website: [www.onsemi.com](http://www.onsemi.com)

### ONLINE SUPPORT: [www.onsemi.com/support](http://www.onsemi.com/support)

For additional information, please contact your local Sales Representative at [www.onsemi.com/support/sales](http://www.onsemi.com/support/sales)

