

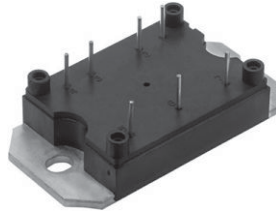

Three Phase Bridge (Power Modules), 45 A to 100 A



MT...PA



MT...PB

FEATURES

- Low V_F
- Low profile package
- Direct mounting to heatsink
- Flat pin/round pin versions with PCB solderable terminals
- Low junction to case thermal resistance
- 3500 V_{RMS} insulation voltage
- UL approved file E78996 
- Designed and qualified for industrial level
- Material categorization: for definitions of compliance please see www.vishay.com/doc?99912



RoHS COMPLIANT

APPLICATIONS

- Power conversion machines
- Welding
- UPS
- SMPS
- Motor drives
- General purpose and heavy duty application

DESCRIPTION

A range of extremely compact three phase rectifier bridges offering efficient and reliable operation. The low profile package has been specifically conceived to maximize space saving and optimize the electrical layout of the application specific power supplies.

PRIMARY CHARACTERISTICS	
I_o	45 A to 100 A
V_{RRM}	1600 V
Package	MTP
Circuit configuration	Three phase bridge

MAJOR RATINGS AND CHARACTERISTICS					
SYMBOL	CHARACTERISTICS	VALUES 40MT	VALUES 70MT	VALUES 100MT	UNITS
I_o		45	75	100	A
	T_C	100	80	80	°C
I_{FSM}	50 Hz	270	380	450	A
	60 Hz	280	398	470	
I^2t	50 Hz	365	724	1013	A ² s
	60 Hz	325	660	920	
$I^2\sqrt{t}$		3650	7240	10 130	A ² √s
V_{RRM}		1600			V
T_{Stg}	Range	- 40 to + 150			°C
T_J		- 40 to + 150			

ELECTRICAL SPECIFICATIONS

VOLTAGE RATINGS				
TYPE NUMBER	VOLTAGE CODE REVERSE VOLTAGE V	V_{RRM} , MAXIMUM REPETITIVE PEAK REVERSE VOLTAGE V	V_{RSM} , MAXIMUM NON-REPETITIVE PEAK V	I_{RRM} MAXIMUM AT $T_J = 150\text{ °C}$ mA
VS-40MT160P, VS-70MT160P, VS-100MT160P	160	1600	1700	5



FORWARD CONDUCTION								
PARAMETER	SYMBOL	TEST CONDITIONS		VALUES 40MT	VALUES 70MT	VALUES 100MT	UNITS	
Maximum DC output current at case temperature	I _O	120° rect. to conduction angle		45	75	100	A	
				100	80	80	°C	
Maximum peak, one cycle forward, non-repetitive on state surge current	I _{FSM}	t = 10 ms	No voltage reapplied	Initial T _J = T _J maximum	270	380	450	A
		t = 8.3 ms			280	398	470	
		t = 10 ms	100 % V _{RRM} reapplied		225	320	380	
		t = 8.3 ms			240	335	400	
Maximum I ² t for fusing	I ² t	t = 10 ms	No voltage reapplied	Initial T _J = T _J maximum	365	724	1013	A ² s
		t = 8.3 ms			325	660	920	
		t = 10 ms	100 % V _{RRM} reapplied		253	512	600	
		t = 8.3 ms			240	467	665	
Maximum I ² √t for fusing	I ² √t	t = 0.1 ms to 10 ms, no voltage reapplied		3650	7240	10 130	A ² √s	
Value of threshold voltage	V _{F(TO)}	T _J maximum		0.78	0.82	0.75	V	
Slope resistance	r _t			14.8	9.5	8.1	mΩ	
Maximum forward voltage drop	V _{FM}	T _J = 25 °C; t _p = 400 μs single junction (40MT, I _{pk} = 40 A) (70MT, I _{pk} = 70 A) (100MT, I _{pk} = 100 A)		1.45	1.45	1.51	V	

INSULATION TABLE							
PARAMETER	SYMBOL	TEST CONDITIONS		VALUES 40MT	VALUES 70MT	VALUES 100MT	UNITS
RMS insulation voltage	V _{INS}	T _J = 25 °C, all terminal shorted, f = 50 Hz, t = 1 s		3500			V

THERMAL AND MECHANICAL SPECIFICATIONS							
PARAMETER	SYMBOL	TEST CONDITIONS		VALUES 40MT	VALUES 70MT	VALUES 100MT	UNITS
Maximum junction operating temperature range	T _J			- 40 to + 150			°C
Maximum storage temperature range	T _{Stg}			- 40 to + 150			
Maximum thermal resistance, junction to case	R _{thJC}	DC operation per module		0.27	0.23	0.19	K/W
		DC operation per junction		1.6	1.38	1.14	
		120° rect. conduction angle per module		0.38	0.29	0.22	
		120° rect. conduction angle per junction		2.25	1.76	1.29	
Maximum thermal resistance, case to heatsink per module	R _{thCS}	Mounting surface smooth, flat and greased Heatsink compound thermal conductivity = 0.42W/mK		0.1			
Mounting torque to heatsink ± 10 %		A mounting compound is recommended and the torque should be rechecked after a period of 3 h to allow for the spread of the compound. Lubricated threads		4			Nm
Approximate weight				65			g

CLEARANCE AND CREEPAGE DISTANCES					
PARAMETER	TEST CONDITIONS		MT...PA	MT...PB	UNITS
Clearance	External shortest distances in air between terminals which are not internally short circuited together		10.9	12.3	mm
Creepage distance	Shortest distance along external surface of the insulating material between terminals which are not internally short circuited together				

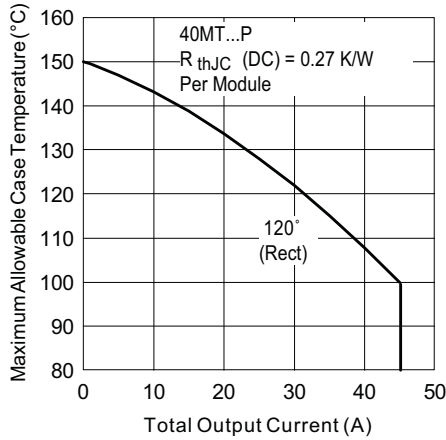

Fig. 1 - Current Rating Characteristics

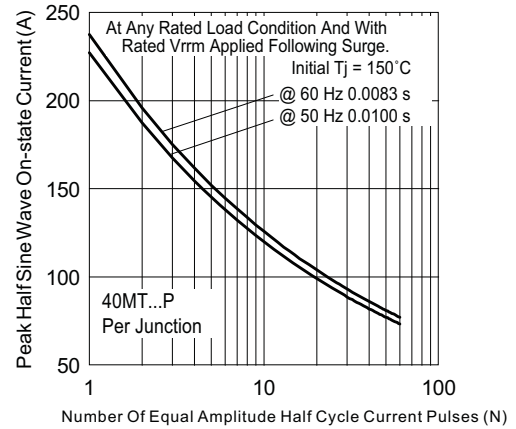

Fig. 3 - Maximum Non-Repetitive Surge Current

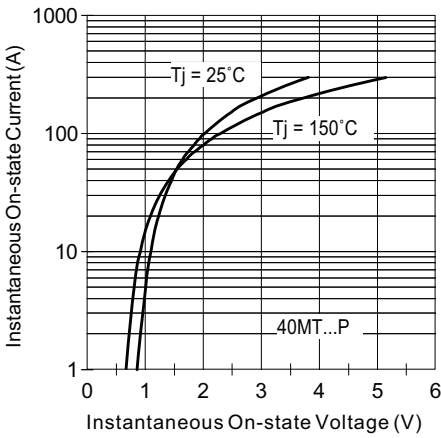

Fig. 2 - On-State Voltage Drop Characteristics

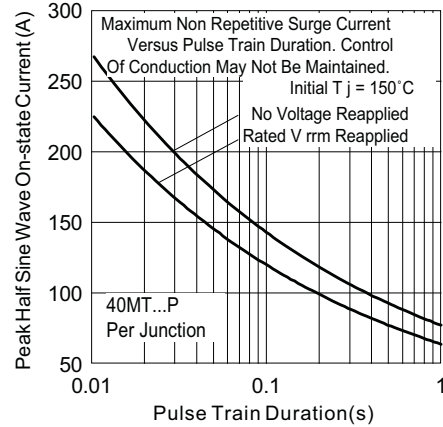

Fig. 4 - Maximum Non-Repetitive Surge Current

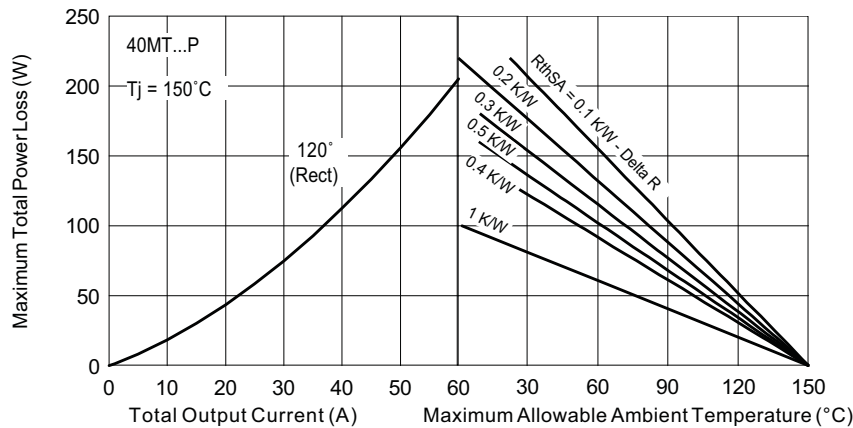

Fig. 5 - Current Rating Nomogram (1 Module Per Heatsink)

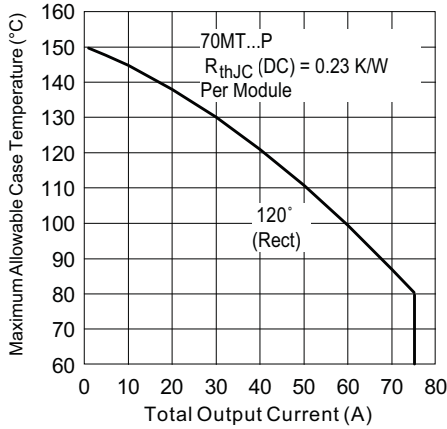

Fig. 6 - Current Rating Characteristics

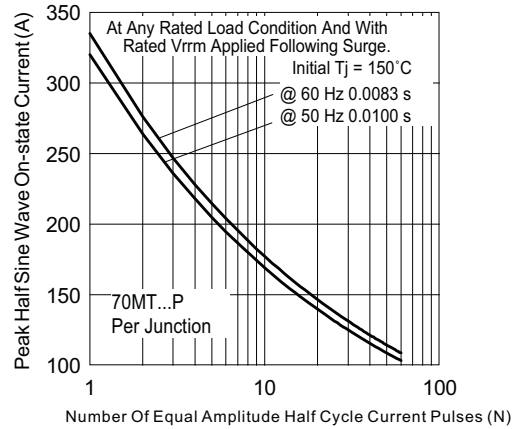

Fig. 8 - Maximum Non-Repetitive Surge Current

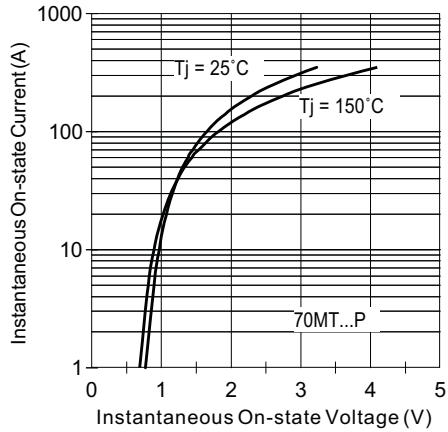

Fig. 7 - On-State Voltage Drop Characteristics

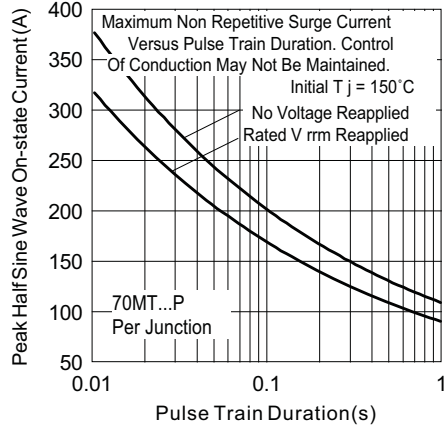

Fig. 9 - Maximum Non-Repetitive Surge Current

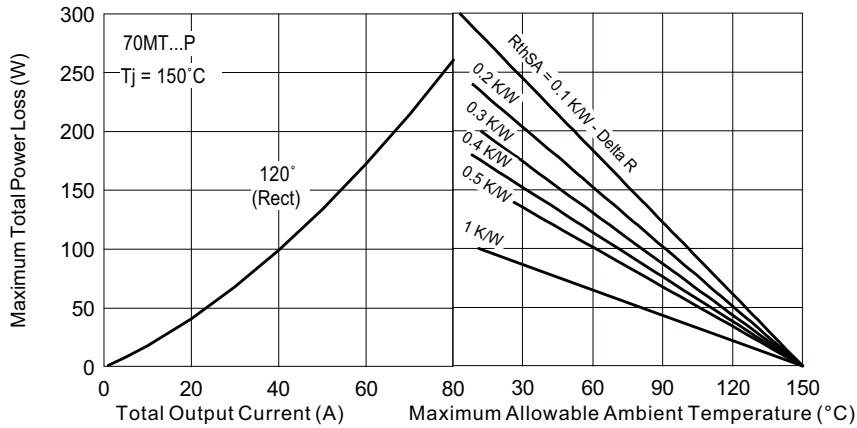

Fig. 10 - Current Rating Nomogram (1 Module Per Heatsink)

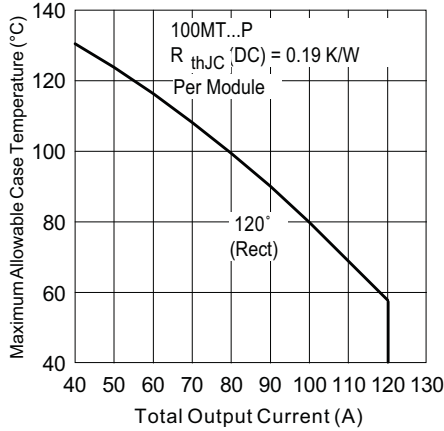

Fig. 11 - Current Rating Characteristics

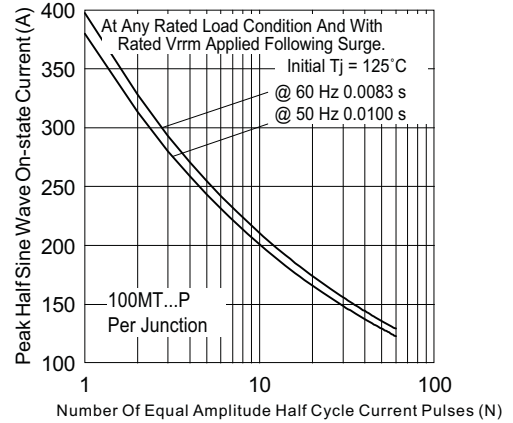

Fig. 13 - Maximum Non-Repetitive Surge Current

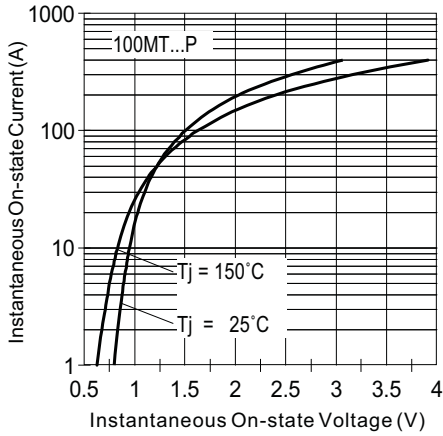

Fig. 12 - On-State Voltage Drop Characteristics

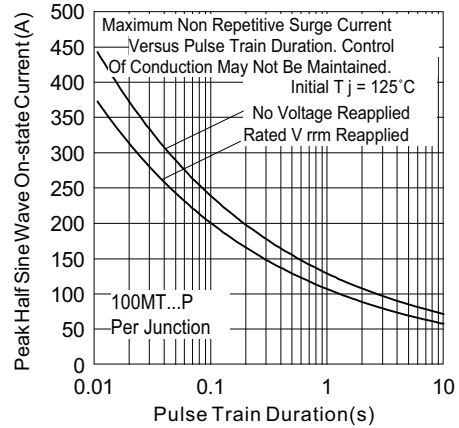

Fig. 14 - Maximum Non-Repetitive Surge Current

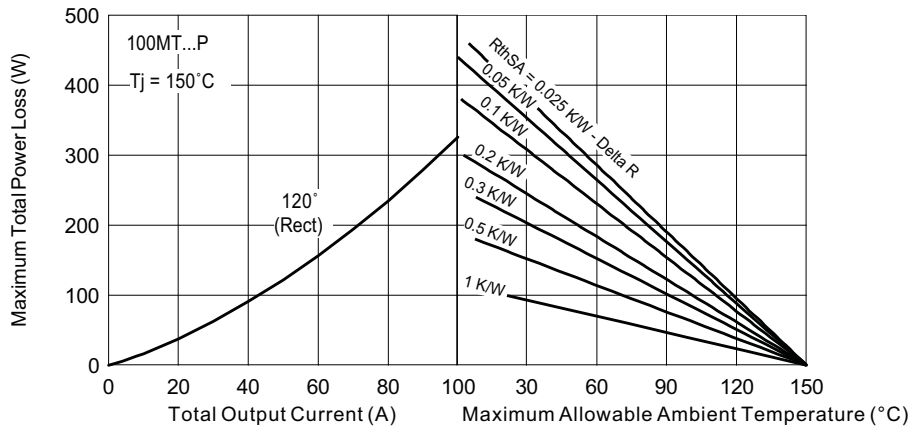

Fig. 15 - Current Rating Nomogram (1 Module Per Heatsink)

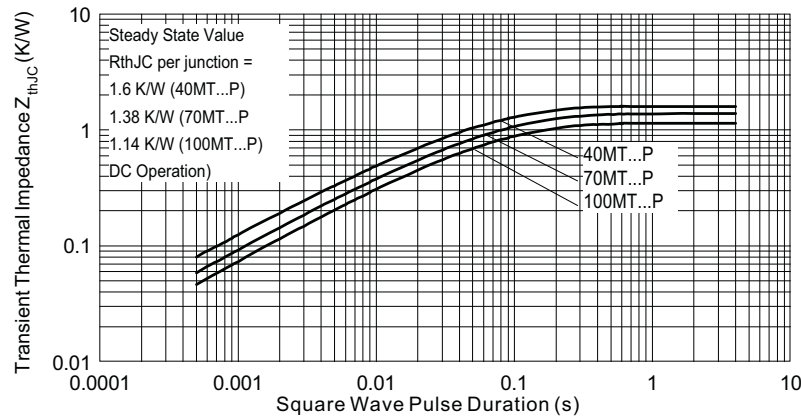
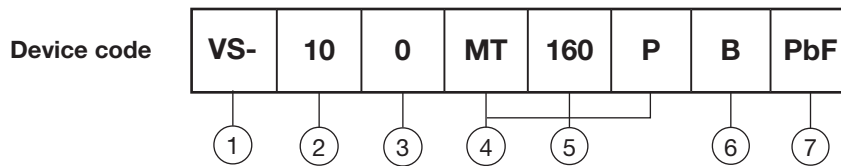

Fig. 16 - Thermal Impedance Z_{thJC} Characteristics

ORDERING INFORMATION TABLE



- 1** - Vishay Semiconductors product
- 2** - Current rating code

4 = 45 A
7 = 75 A
10 = 100 A
- 3** - Circuit configuration code: 0 = three phase rectifier bridge
- 4** - Essential part number
- 5** - Voltage code x 10 = V_{RRM} (see Voltage Ratings table)
- 6** - Pinout code

A = flat pins
B = round pins
- 7** - Lead (Pb)-free

CIRCUIT CONFIGURATION

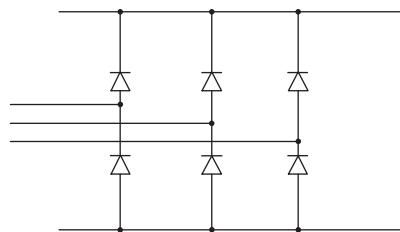

LINKS TO RELATED DOCUMENTS	
Dimensions	www.vishay.com/doc?95244



MTP Flat and Round Pin

DIMENSIONS FOR MTP WITH FLAT PIN in millimeters

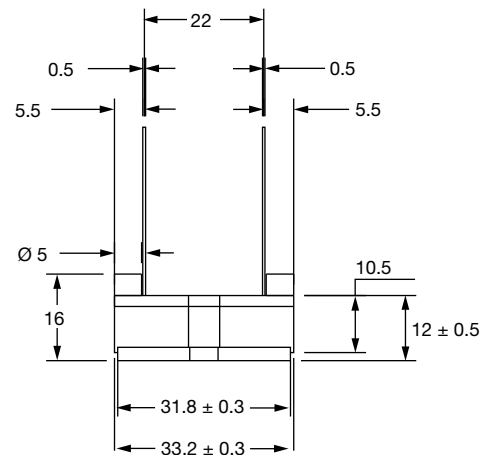
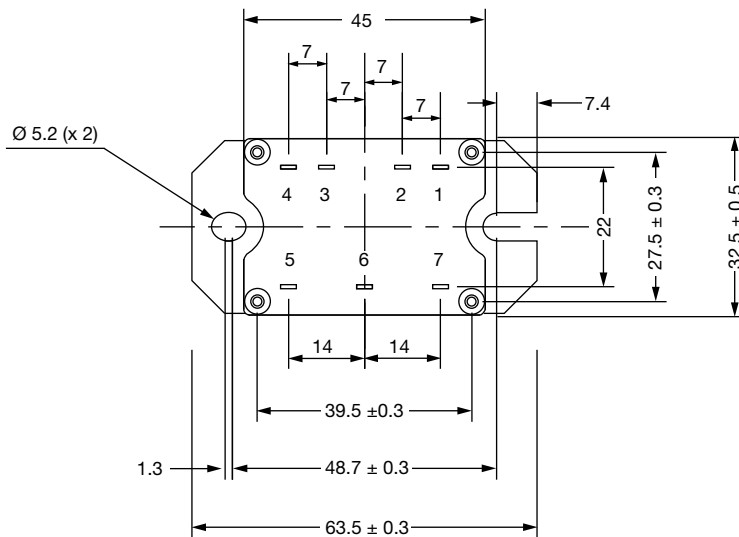
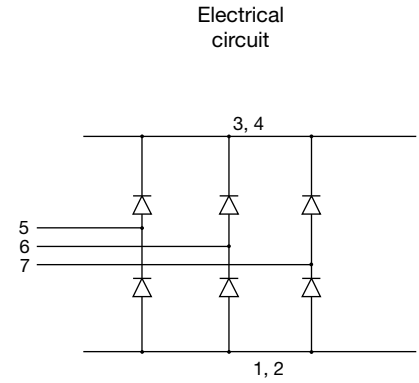
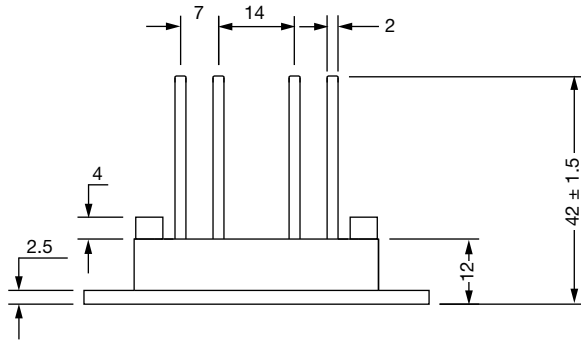

Tolerance (unless other stated):

X = ± 0.3

X.X = ± 0.1

X.XX = ± 0.03



DIMENSIONS FOR MTP WITH ROUND PIN in millimeters

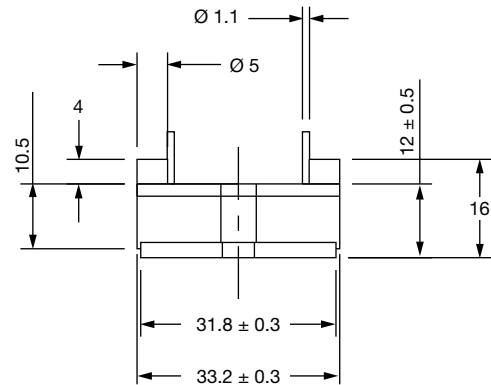
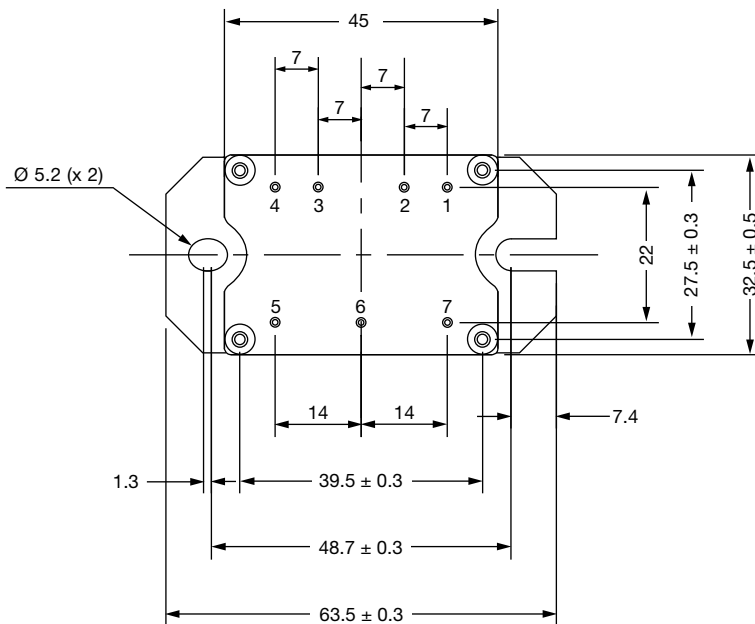
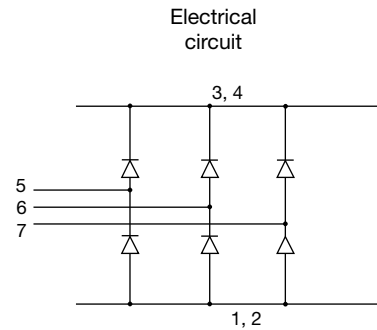
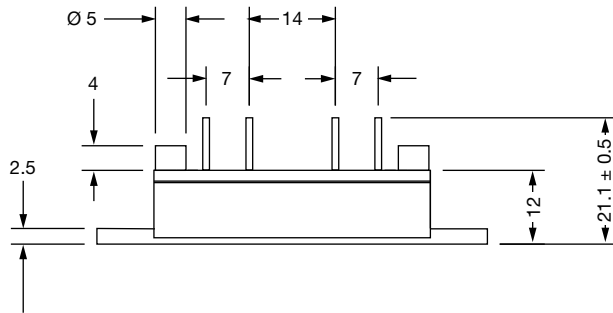

Tolerance (unless other stated):

X = ± 0.3

X.X = ± 0.1

X.XX = ± 0.03



Disclaimer

ALL PRODUCT, PRODUCT SPECIFICATIONS AND DATA ARE SUBJECT TO CHANGE WITHOUT NOTICE TO IMPROVE RELIABILITY, FUNCTION OR DESIGN OR OTHERWISE.

Vishay Intertechnology, Inc., its affiliates, agents, and employees, and all persons acting on its or their behalf (collectively, "Vishay"), disclaim any and all liability for any errors, inaccuracies or incompleteness contained in any datasheet or in any other disclosure relating to any product.

Vishay makes no warranty, representation or guarantee regarding the suitability of the products for any particular purpose or the continuing production of any product. To the maximum extent permitted by applicable law, Vishay disclaims (i) any and all liability arising out of the application or use of any product, (ii) any and all liability, including without limitation special, consequential or incidental damages, and (iii) any and all implied warranties, including warranties of fitness for particular purpose, non-infringement and merchantability.

Statements regarding the suitability of products for certain types of applications are based on Vishay's knowledge of typical requirements that are often placed on Vishay products in generic applications. Such statements are not binding statements about the suitability of products for a particular application. It is the customer's responsibility to validate that a particular product with the properties described in the product specification is suitable for use in a particular application. Parameters provided in datasheets and / or specifications may vary in different applications and performance may vary over time. All operating parameters, including typical parameters, must be validated for each customer application by the customer's technical experts. Product specifications do not expand or otherwise modify Vishay's terms and conditions of purchase, including but not limited to the warranty expressed therein.

Hyperlinks included in this datasheet may direct users to third-party websites. These links are provided as a convenience and for informational purposes only. Inclusion of these hyperlinks does not constitute an endorsement or an approval by Vishay of any of the products, services or opinions of the corporation, organization or individual associated with the third-party website. Vishay disclaims any and all liability and bears no responsibility for the accuracy, legality or content of the third-party website or for that of subsequent links.

Vishay products are not designed for use in life-saving or life-sustaining applications or any application in which the failure of the Vishay product could result in personal injury or death unless specifically qualified in writing by Vishay. Customers using or selling Vishay products not expressly indicated for use in such applications do so at their own risk. Please contact authorized Vishay personnel to obtain written terms and conditions regarding products designed for such applications.

No license, express or implied, by estoppel or otherwise, to any intellectual property rights is granted by this document or by any conduct of Vishay. Product names and markings noted herein may be trademarks of their respective owners.