Getting Started with the SAM L10/L11 Xplained Pro

Abstract

This application note aims at getting started with the Atmel® SAM L10 and SAM L11 ARM®Cortex®-M23 based microcontrollers using their respective Xplained Pro evaluation kits.

The Atmel SAM L10 and SAM L11 Xplained Pro evaluation kits are hardware platforms used to evaluate the ATSAML10E16A and ATSAML11E16A microcontrollers.

Each kit is supported by the Atmel Studio Integrated development Platform, and provides an easy access to the features of the microcontroller.

Table of Contents

Abstract.....	1
1. Device Documentation.....	3
2. Obtain the SAM L10/SAM L11 Xplained Pro Evaluation Kit.....	4
3. Obtain the Tools.....	6
4. Getting Started With SAM L10/SAM L11 Using Atmel Studio 7 and START.....	7
4.1. Instructional Guide	7
5. Getting Started With SAM L11 Secure Solution Using Atmel Studio 7 and Start....	13
5.1. SAM L11 Security Concept Overview.....	13
5.2. Instructional Guide.....	15
The Microchip Web Site.....	38
Customer Change Notification Service.....	38
Customer Support.....	38
Microchip Devices Code Protection Feature.....	38
Legal Notice.....	39
Trademarks.....	39
Quality Management System Certified by DNV.....	40
Worldwide Sales and Service.....	41

1. Device Documentation

Data Sheet

Web page: <http://www.microchip.com/>.

Document: SAM L10/L11 Family Data Sheet, which provides peripheral descriptions and electrical characteristics.

Silicon Errata

Web page: <http://www.microchip.com/>.

Document: SAM L10/L11 Family Silicon Errata and Data Sheet Clarification.

2. Obtain the SAM L10/SAM L11 Xplained Pro Evaluation Kit

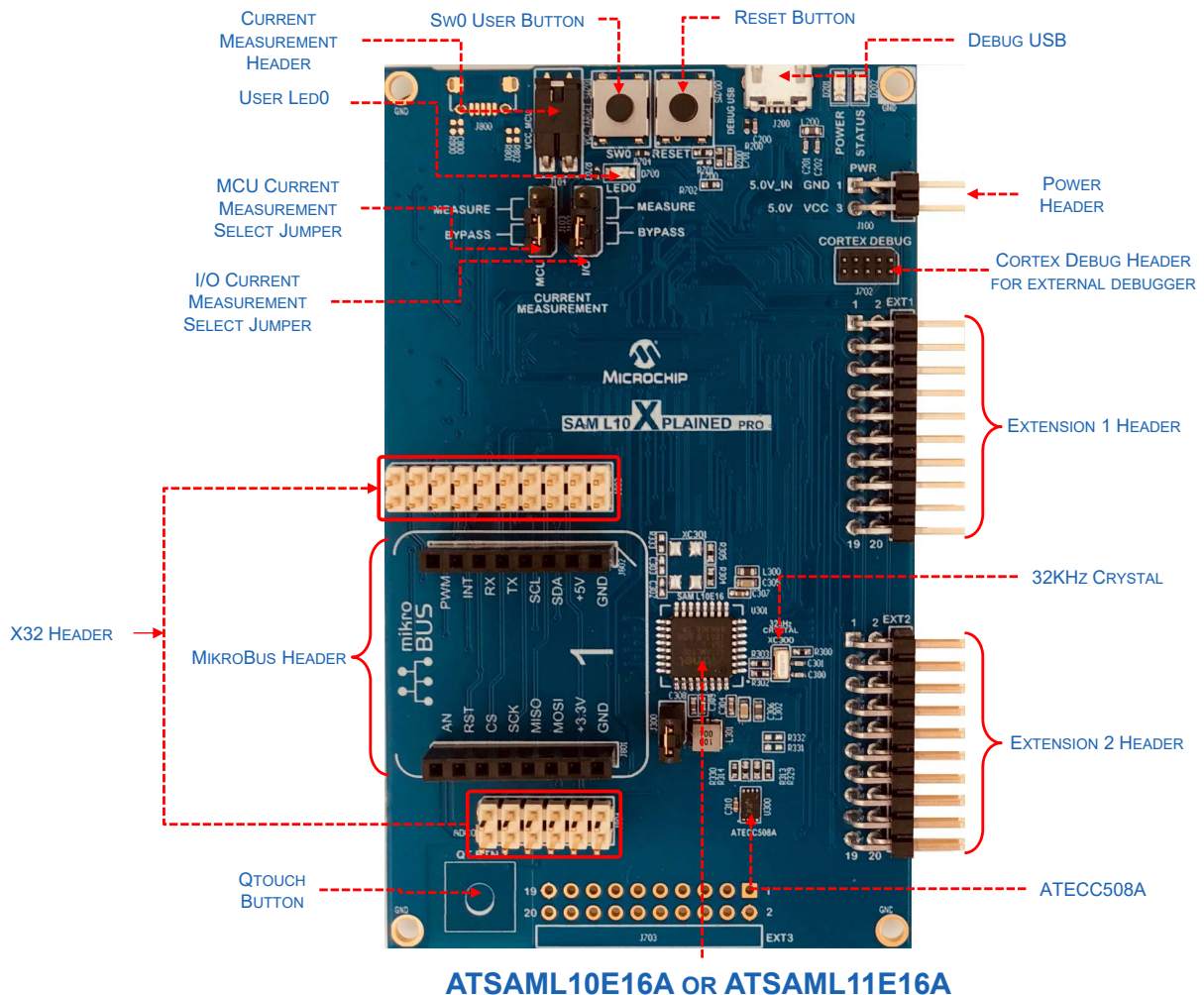

Web page: <http://www.microchip.com/>.

To order the kit, access [Microchip Direct](#)

Documents:

- SAM L10/L11 Xplained Pro User Guide (.pdf)
- SAML10-Xplained-Pro_Design-Documentation (.zip)
- SAML11-Xplained-Pro_Design-Documentation (.zip)

Key Features:

- ATSAML10E16A-AU or ATSAML11E16A-AU microcontrollers
- One mechanical reset button
- One mechanical programmable button
- One QTouch® button
- One user LED (yellow)
- 32.768 kHz crystal

- ATECC508A Crypto Authentication IC
- Two Xplained Pro extension headers
- One X32 header
- One mikroBUS header
- Embedded Debugger
 - Auto-ID for board identification in Atmel Studio
 - One status LED (yellow)
 - One board power LED (green)
 - Symbolic debug of complex data types including scope information
 - Programming and debugging, including power measurements
 - Data Gateway Interface: SPI, I²C, four GPIOs
 - Virtual COM-port (CDC)
- Embedded current measurement circuitry with Atmel Data Visualizer support for data visualization
- USB powered



Tip: The SAM L10/SAM L11 Xplained Pro User's Guide describes how to power the kit, and it also describes the detailed information on board components, extension interface and the hardware guide.

3. Obtain the Tools

Atmel Studio 7, which uses a GCC compiler, is the preferred IDE to get started with SAM L10/SAM L11 MCUs. Atmel START is the preferred user interface to generate the initial project. Any Atmel START project can be used in Atmel Studio 7, IAR or KEIL IDEs.

Atmel Studio 7

- **Web page:** [Atmel Studio](#)
Document: Atmel Studio 7.0 web installer(.exe)

Atmel Studio 7 is the preferred IDE for developing and debugging firmware for SAM L10/SAM L11.

Atmel Start

- **Web page:** [Atmel Start](#)
Document: Atmel Start User's guide: Also, use the help menu from the interface.

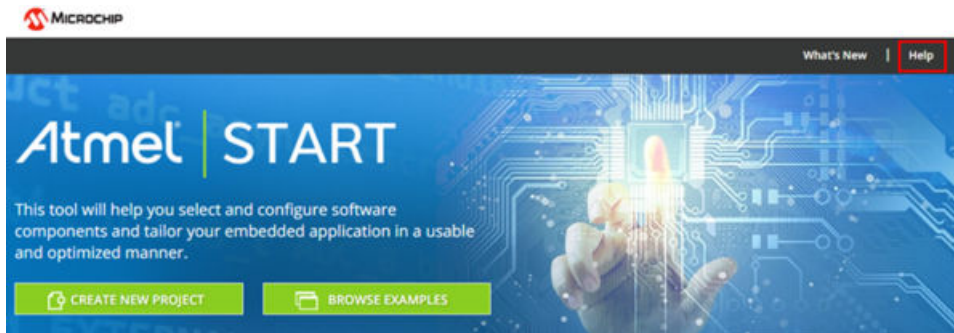

Atmel Start enables users to select and configure software components and tailor embedded applications in a usable and optimized manner.

4. Getting Started With SAM L10/SAM L11 Using Atmel Studio 7 and START

Note: The following steps are described using the SAM L10 Xplained Pro as reference; however, the same sequence can be performed using the SAM L11 Xplained Pro.

4.1 Instructional Guide

Follow these steps to start exploring the Atmel Xplained Pro platform:

1. Download [Atmel Studio](#).
2. Install Atmel Studio.
3. Launch Atmel Studio.



- Connect the kit to the PC using a micro-USB cable (Standard-A to Micro-AB).
When the Xplained Pro MCU kit is connected to the computer for the first time, the operating system will install the software driver. The driver file supports both 32-bit and 64-bit versions of Microsoft® Windows®XP, Windows Vista®, Windows 7, Windows 8 and Windows 10.

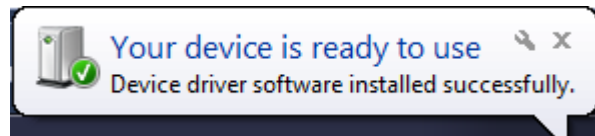

When the Xplained Pro MCU board is powered, the power LED (green) will glow and Atmel Studio will auto-detect the specific Xplained Pro MCU and extension boards that might be connected. Atmel Studio will provide links to relevant information, such as data sheets and kit documentation.

Note: The ATSAML10E16A and ATSAML11E16A devices are programmed and debugged by the on-board embedded debugger, hence no external programmer or debugger tool is required.

Figure 4-1. Atmel Studio SAM L10/SAM L11 Xplained Pro Introduction

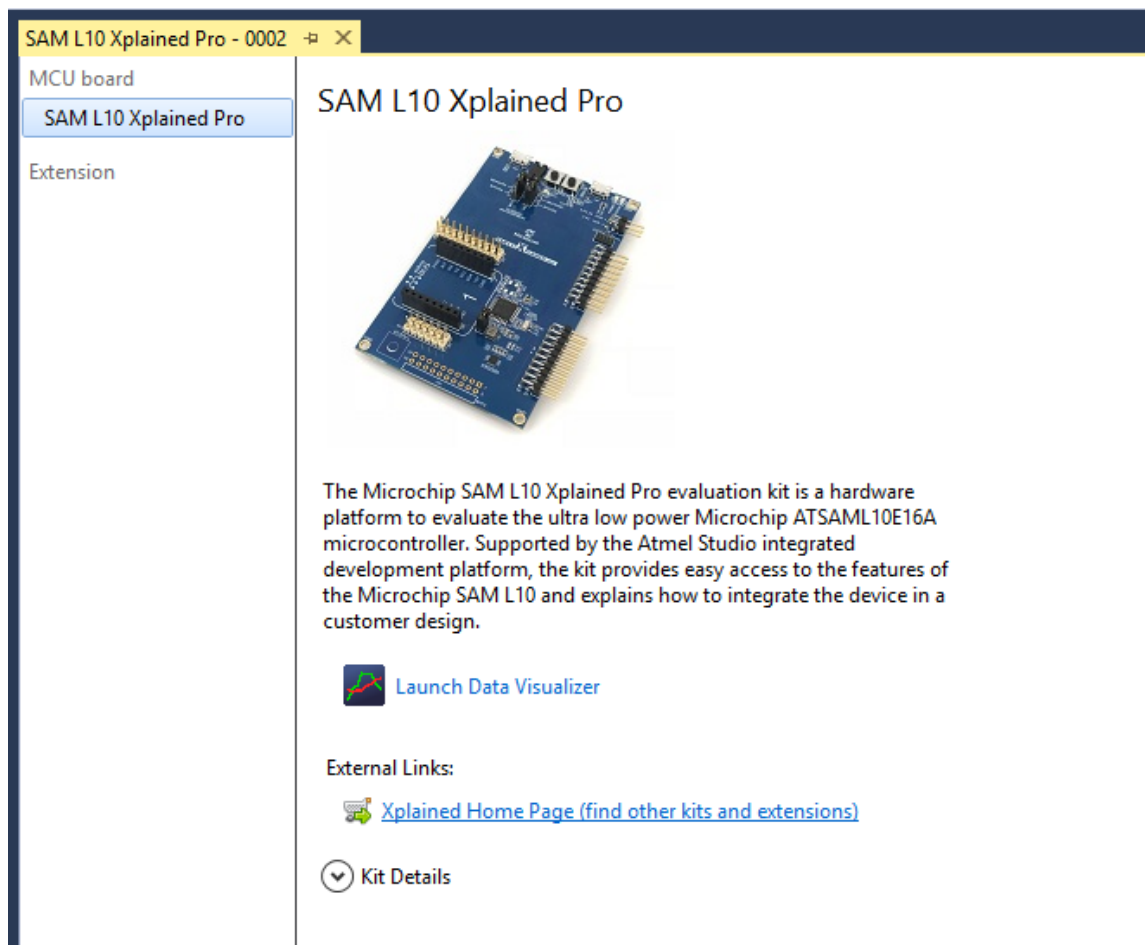

5. Launch Atmel Start from Atmel Studio: *File > New > Atmel Start Example Project*, and then open Atmel Start directly into Atmel studio.

Figure 4-2. Opening Atmel Start Example Project in Atmel Studio

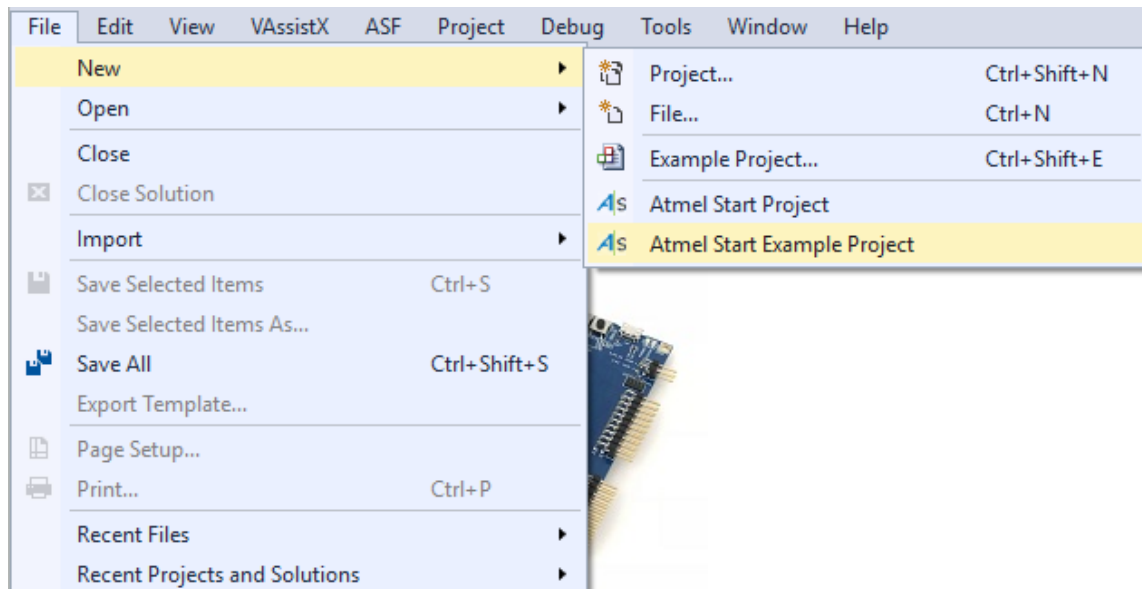

Atmel Start will load the existing example list.

6. Choose the example "LED Flasher" in the list, and then click **Open Selected Example**.

Figure 4-3. Atmel start SAM L1x Available Example List

Name	Categories	Description	Board(s) supported	User guide
Calendar demo	I/O	This example shows the use of the Calendar driver and alarms to blink LED every 10 seconds.	SAM L10 Xplained Pro SAM L11 Xplained Pro	User guide
EDBG UART		This demo uses the UART usage example function to write data to the EDBG Virtual COM Port. Echo back input characters and toggle LED.	SAM L10 Xplained Pro SAM L11 Xplained Pro	User guide
LED flasher	I/O	This example periodically toggles an on-board LED.	SAM L10 Xplained Pro SAM L11 Xplained Pro	User guide
LED switcher	I/O	This example toggles an on-board LED every time when an on-board switch is pressed.	SAM L10 Xplained Pro SAM L11 Xplained Pro	User guide
Low power for SAML1X		This example demonstrates the different low power modes of the SAM L10/L11 which are DLE, STANDBY and OFF modes.	SAM L10 Xplained Pro SAM L11 Xplained Pro	User guide
PWM Example		This demo read light sensor on IO Xplained over ADC, and then output PWM on LED to reflect the current measured light level.	SAM L10 Xplained Pro SAM L11 Xplained Pro	User guide
Smart Card Example		This example does a read and write data example for smart	SAM L10 Xplained Pro	User guide

Showing 7 of 14 examples.

OPEN SELECTED EXAMPLE >

7. Choose either the SAM L10 or SAM L11 Xplained Pro Board, and then click **Select board**.

Figure 4-4. Board Selection

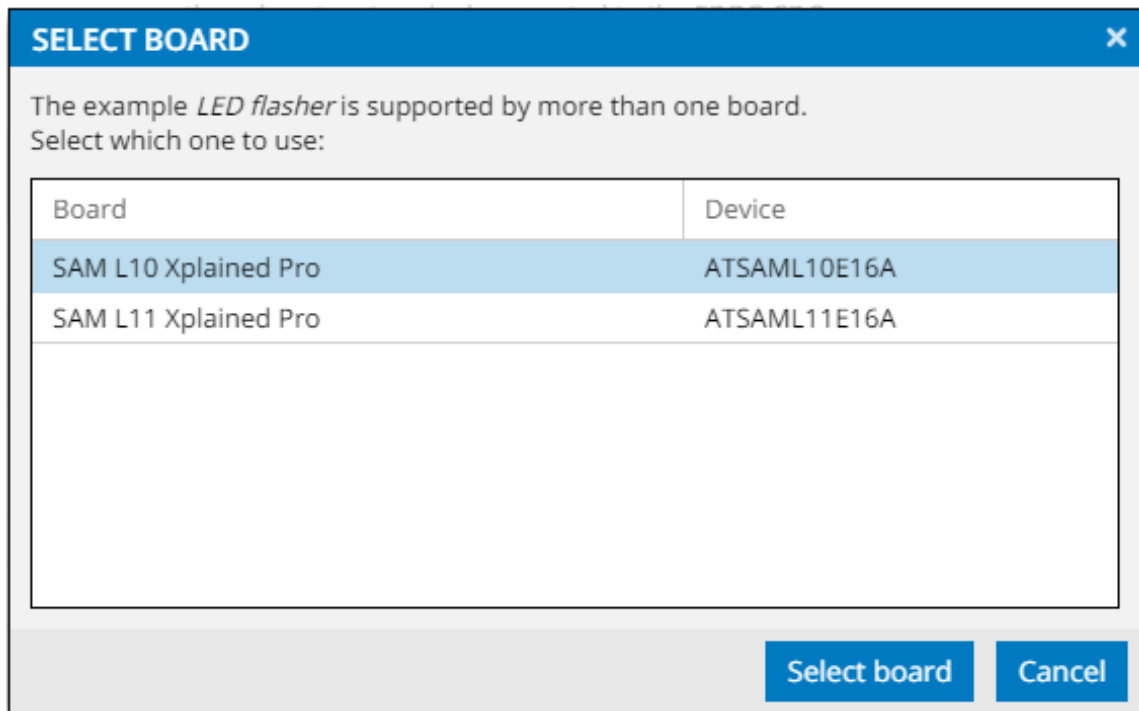

SELECT BOARD X

The example *LED flasher* is supported by more than one board.
Select which one to use:

Board	Device
SAM L10 Xplained Pro	ATSAML10E16A
SAM L11 Xplained Pro	ATSAML11E16A

Select board Cancel

- Click **GENERATE PROJECT** to generate the project from Atmel Start. My "Software Components Window" will be displayed.

Figure 4-5. Atmel Start Project Generation

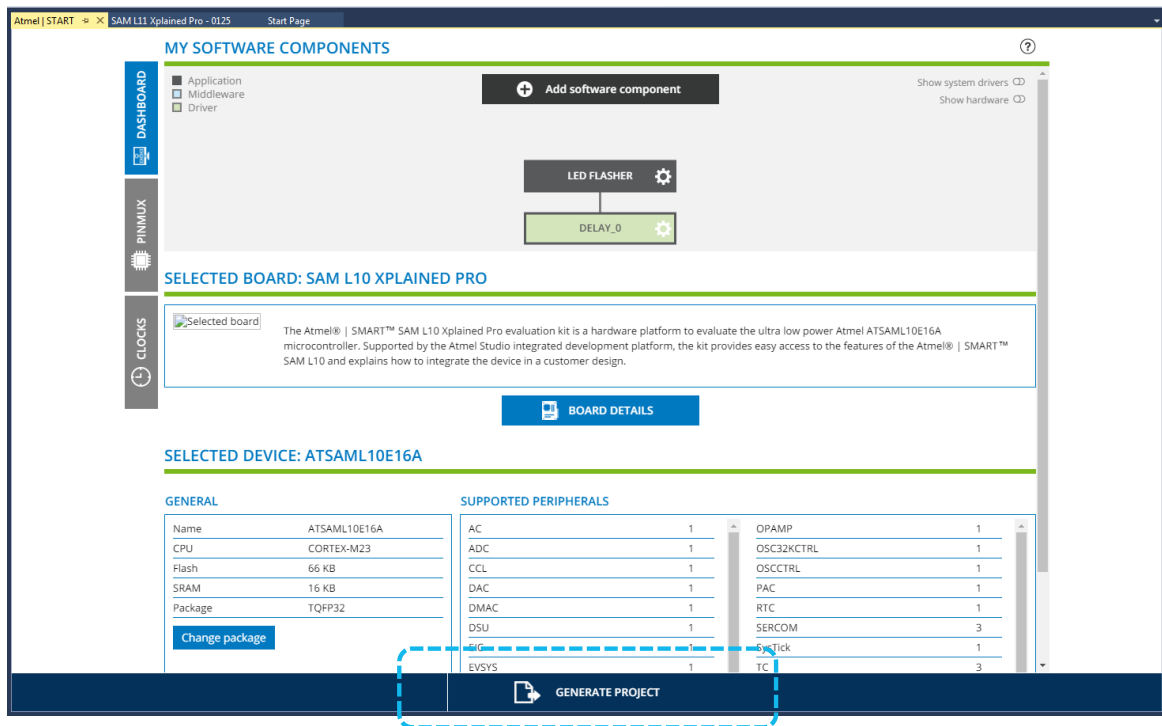

- The following window will be displayed: Enter Project Name, Solution, Solution Name, and then browse and choose a location for the project. Click **OK** to open the project in Atmel Studio.

Figure 4-6. Atmel Studio New Atmel Start Project Importation

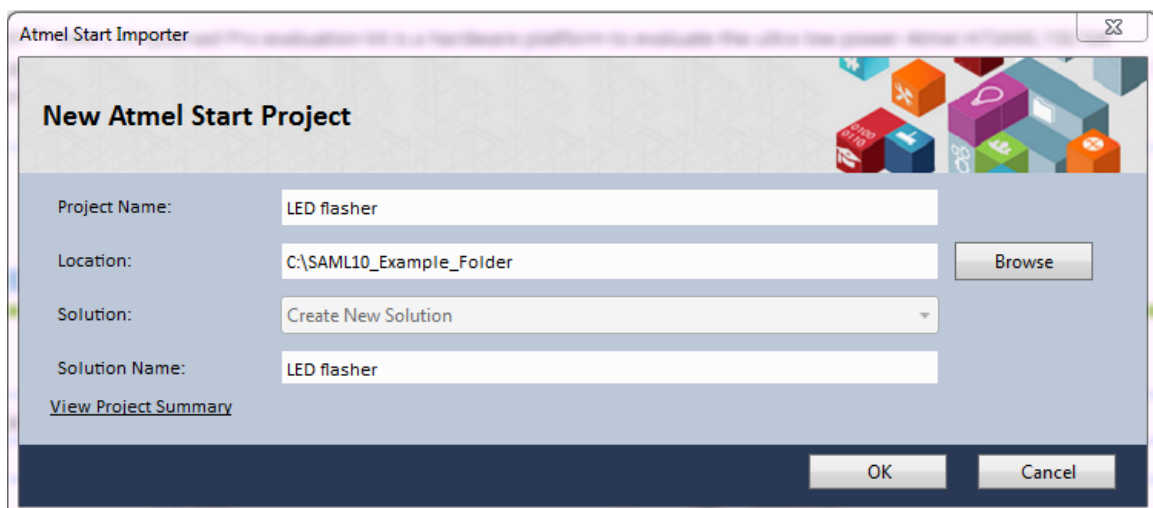

The Atmel Studio will create the project.

10. Configure the Debugger/Programmer Interface by following these steps:
 - Open the project properties: *Project > Properties* or <ALT+F7>.
 - Click **Tool**.
 - For the Selected debugger/programmer, choose "EDBG ATMLxxx".
 - For the Interface, choose "SWD".

Figure 4-7. Programming Tool Selection

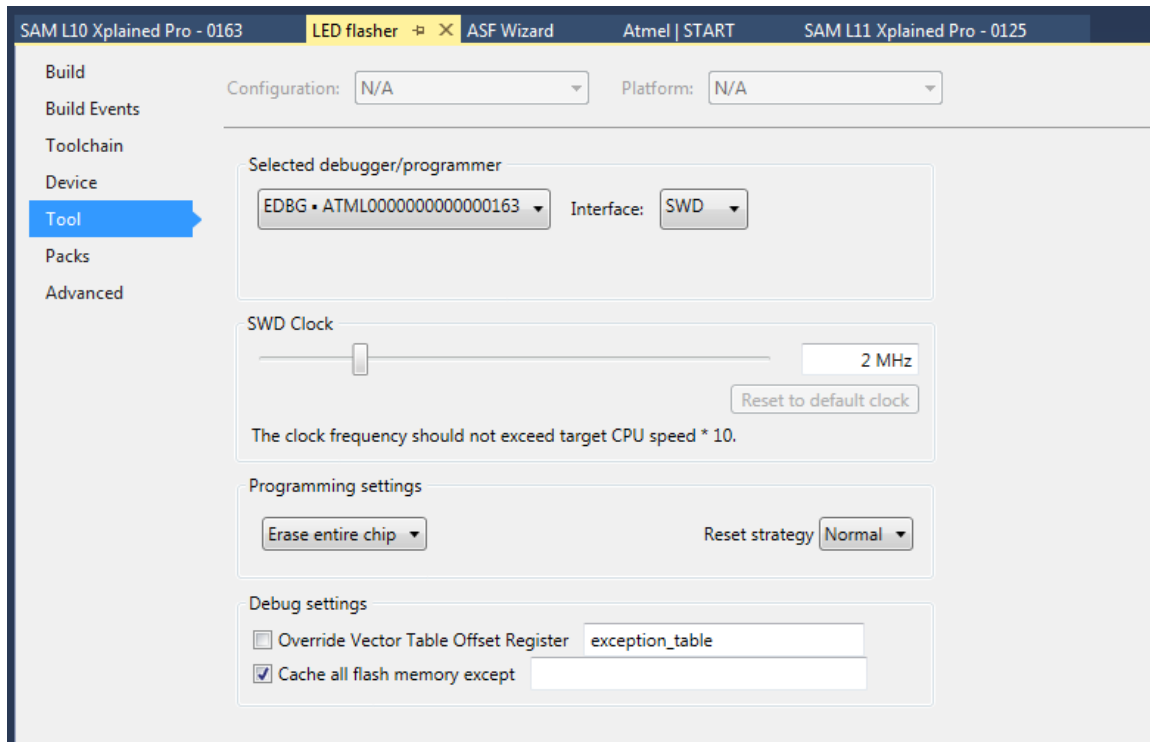

11. Compile and run the LED Flasher application.
 - Build the project: *Build > Build Solution* or <F7>.
 - Load the code into the SAM L10 Xplained Pro and start debugging: *Debug > Start debugging and break* or <ALT+F5>.
 - The application is programmed and the debugger breaks in main.
 - Run the code: *Debug > Continue* or <F5>.
 - The example runs out of the Xplained Pro target.

5. Getting Started With SAM L11 Secure Solution Using Atmel Studio 7 and Start

5.1 SAM L11 Security Concept Overview

Using the ATSAM L11 requires to be familiar with different security features and concepts that involve a TrustZone® for ARMv8-M devices.

The TrustZone technology is a System-on-Chip (SoC) and MCU system-wide approach to security that enables Secure and Non-Secure code to run on a MCU. It enables creating multiple software security domains that restrict access to selected memory, peripherals, and I/O to trusted software without compromising the system performances. The user can consider the following deployment approaches:

- Single-developer approach (Customer A)
- Dual-developer approach (Customer A+ Customer B)

The Single developer approach involves a unique developer (Customer A), which is in charge of the following:

- Developing, deploying, and protecting the Secure code
- Developing and deploying the Non-Secure code

In the Dual-Developer approach, the first developer (Customer A) is in charge of developing the Secure application and its associated Non-Secure callable library. The Secure Application must be loaded in the SAM L11 NVM and protected.

A different developer (Customer B) will then start Non-Secured application development on a preprogrammed SAM L11 with limited access to Secure resources (call to Non-Secure API only).

Figure 5-1. Single-Developer and Dual Developer Approaches

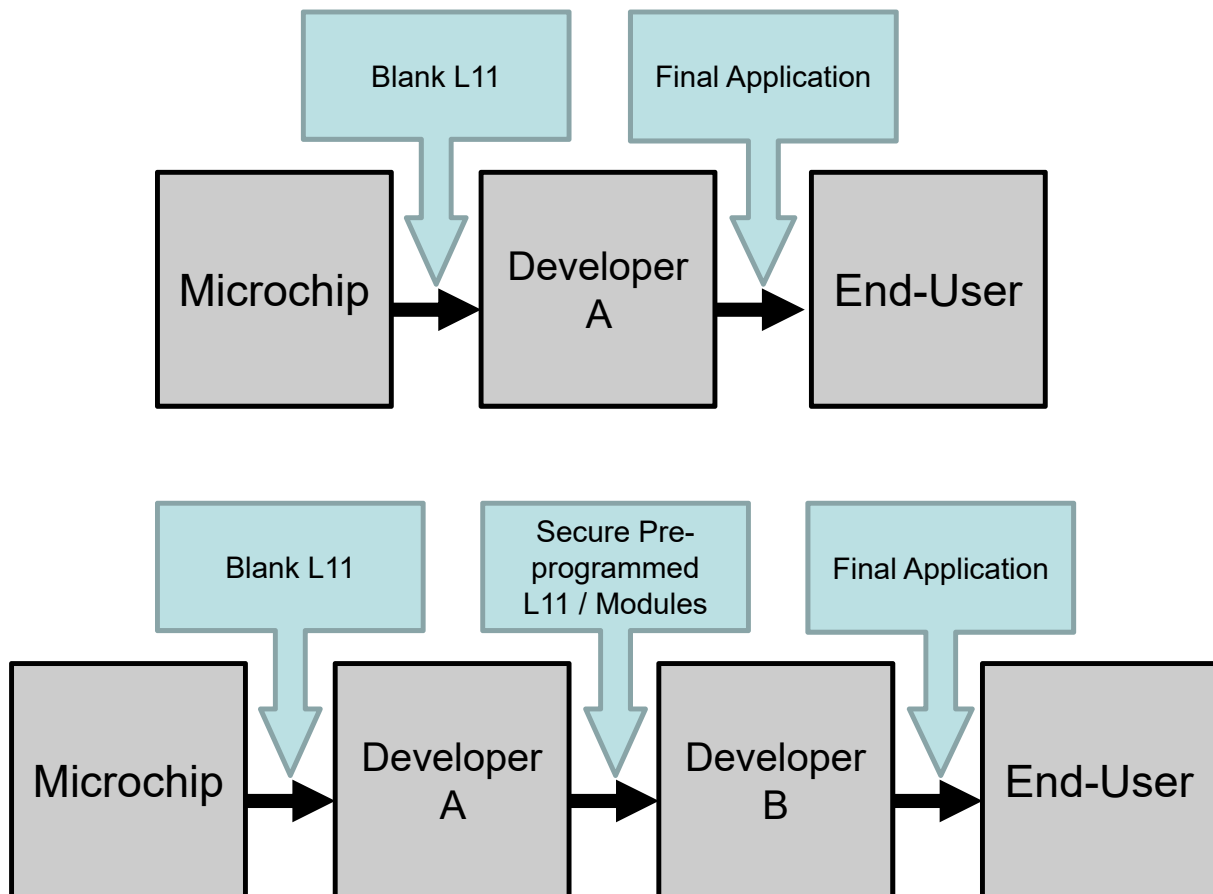

This document describes how to debug a solution composed of the following two projects:

- Secure Project
- Non-Secure Project

Note: Refer to the "SAM L11 Security Reference Guide" application note, which describes the security features available in the Microchip SAM L11 microcontroller that fulfill the security requirement of most embedded systems.

5.2 Instructional Guide

Follow these steps to explore the Atmel Xplained Pro platform:

1. Download [Atmel Studio](#).
2. Install Atmel Studio.
3. Launch Atmel Studio.



4. Connect the DEBUG USB port on the kit to the PC using a micro-USB cable (Standard-A to Micro-AB). When the Xplained Pro MCU kit is connected to the computer for the first time, the operating system will install the software driver. The driver file supports 32-bit and 64-bit versions of Microsoft® Windows®XP, Windows Vista®, Windows 7, Windows 8 and Windows10.

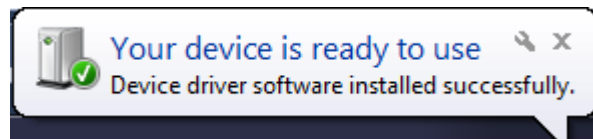

When the Xplained Pro MCU board is powered, the power LED (green) will glow. Atmel Studio will auto-detect the specific Xplained Pro MCU and extension boards that are connected. Atmel Studio will present relevant information, such as data sheets and kit documentation.

The ATSAML11E16A device is programmed and debugged by the on-board embedded debugger, hence no external programmer or debugger tool is required.

Figure 5-2. Atmel Studio SAM L11 Xplained Pro Introduction

A screenshot of the Atmel Studio software interface. The window title is "SAM L11 Xplained Pro - 0020". On the left, there is a sidebar with a tree view containing "MCU board" (with "SAM L11 Xplained Pro" selected) and "Extension". The main area displays the "SAM L11 Xplained Pro" kit. It features a photograph of the blue printed circuit board (PCB) with various components and connectors. Below the photo, there is a descriptive paragraph: "The Microchip SAM L11 Xplained Pro evaluation kit is a hardware platform to evaluate the ultra low power Microchip ATSAML11E16A microcontroller. Supported by the Atmel Studio integrated development platform, the kit provides easy access to the features of the Microchip SAM L11 and explains how to integrate the device in a customer design." Below this text is a button labeled "Launch Data Visualizer" with a small icon. Underneath, it says "External Links:" followed by a link icon and the text "Xplained Home Page (find other kits and extensions)". At the bottom, there is a dropdown arrow icon and the text "Kit Details".

5. Launch Atmel Start from Atmel Studio to Open the Secure Application Project: *File > New > Atmel Start Example Project* and then open Atmel Start into Atmel studio 7.

Figure 5-3. Open a New Atmel Start Example Project in Atmel Studio

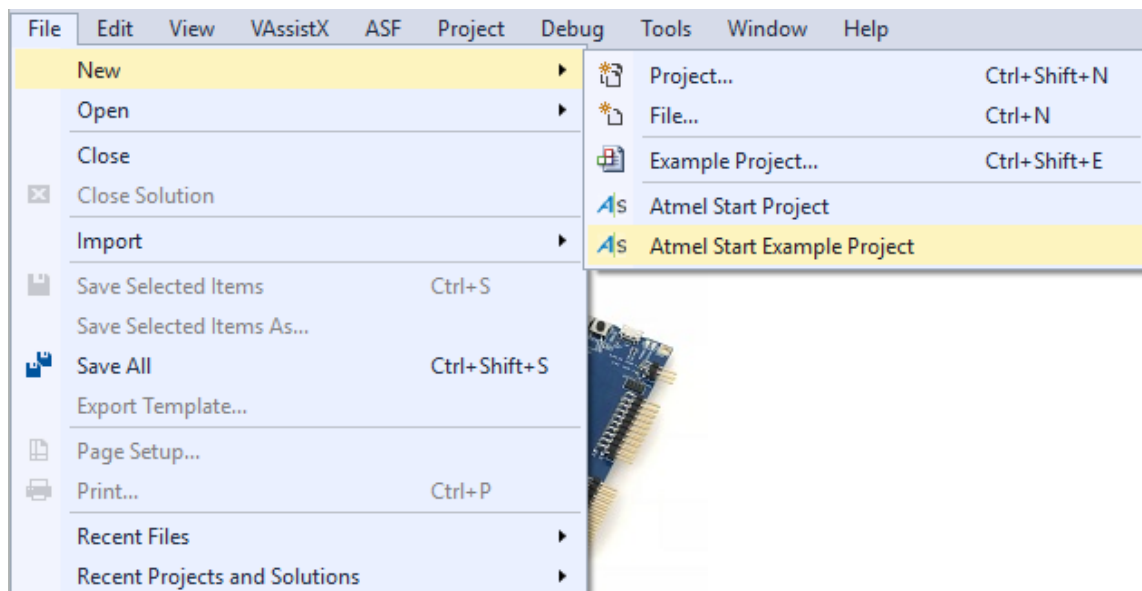

Note: After few seconds the example list will be displayed.

6. Select the "TrustZone Getting Started Example" for the Secure Project (TZ-GetStart-S) from the examples list, and then click **OPEN SELECTED EXAMPLE**.

Figure 5-4. TrustZone Getting started SAM L11 Secure Project Example Selection

Search: Category: Board:

Name	Categories	Description	Board(s) supported	User guide
		ATECC508A CryptoAuthentication™ device to demonstrate secure node provisioning and node authentication using PKI methodology. Specific details include internal key generation, creation of signer and device certificates, and certificate chain verification from device to the certificate root.	SAM L10 Xplained Pro	User guide
PWM Example		This demo read light sensor on IO Xplained over ADC, and then output PWM on LED to reflect the current measured light level.	SAM L10 Xplained Pro SAM L11 Xplained Pro	User guide
Smart Card Example		This example does a read and write data example for smart card.	SAM L10 Xplained Pro SAM L11 Xplained Pro	User guide
TZ-GetStart-NS		Getting started example of using TrustZone for Cortex-M device. This is non-secure project, please use it together with secure project.	SAM L11 Xplained Pro	User guide
TZ-GetStart-S		Getting started example of using TrustZone for Cortex-M device. This is secure project, please use it together with non-secure project.	SAM L11 Xplained Pro	User guide
TZ-MixSecureEIC-NS		This example illustrates the use of TrustZone for Cortex-M device of mix secure peripheral EIC. This is non-secure project, please use it together with secure project.	SAM L11 Xplained Pro	User guide
TZ-MixSecureEIC-S		This example illustrates the use of TrustZone for Cortex-M device of mix secure peripheral EIC. This is secure project, please use it together with non-secure project.	SAM L11 Xplained Pro	User guide
TZ-SecureDriver-NS		This example illustrates the use of TrustZone for Cortex-M device by isolating temperature sensor driver source code	SAM L11 Xplained Pro	User guide

Showing 19 of 19 examples.

OPEN SELECTED EXAMPLE

7. Generate the project from Atmel Start to open it in Atmel Studio. Once the project is open, click **GENERATE PROJECT**.

Figure 5-5. Atmel Start Secure Project Overview and Generation

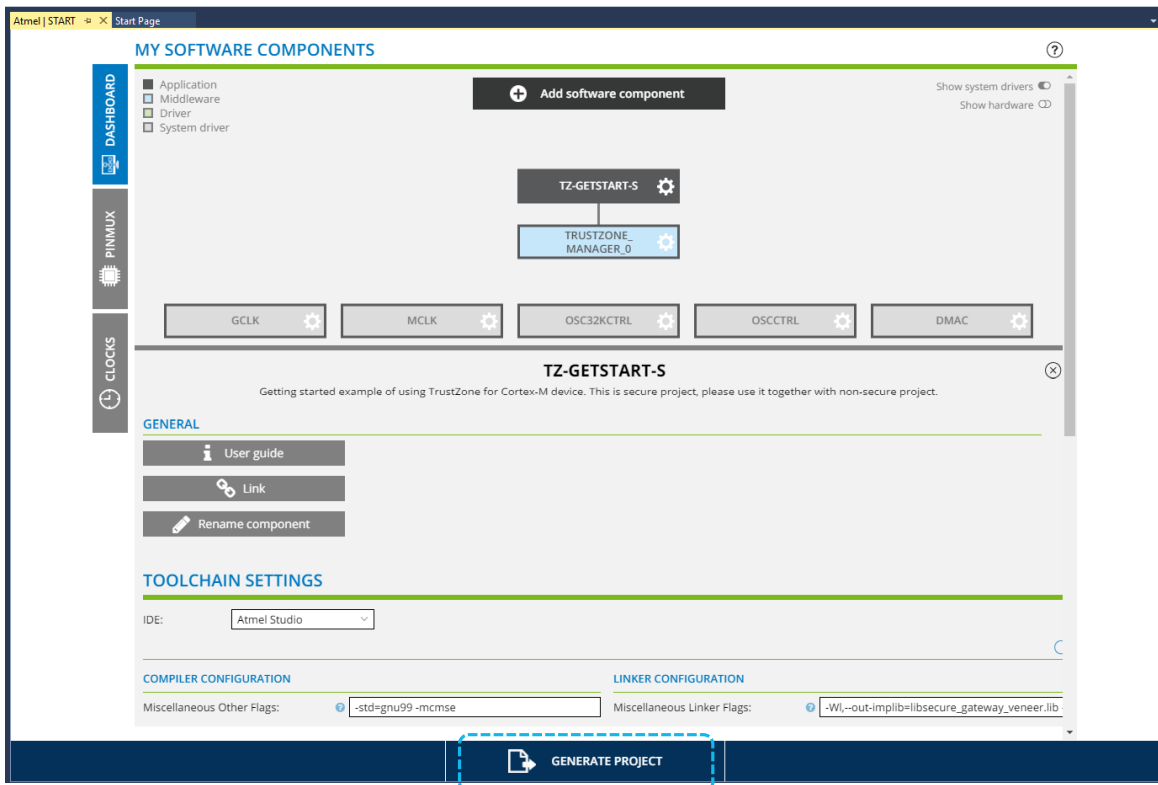

8. The following "New Atmel Start Project" window will be displayed.

Figure 5-6. Secure Project Importation View



9. Modify the following project information:
 - Enter a new Project Name.
 - Click **Browse** to choose a location.
 - For Solution: Create New Solution.
 - For Solution Name, enter *TrustZoneGettingStarted*.
 - Click **OK** to open the project in Atmel Studio.

Figure 5-7. Modifying the Project Information

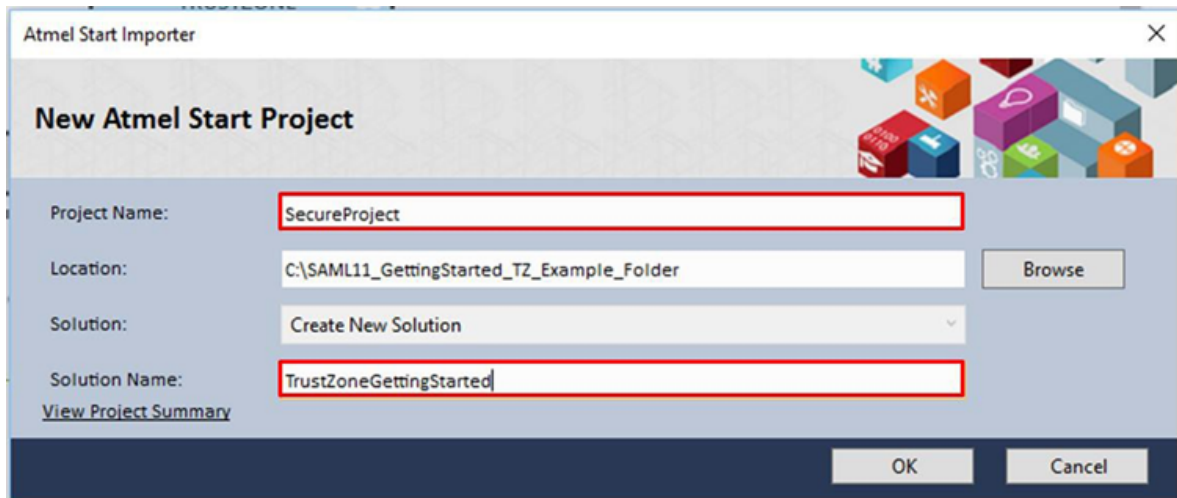

The screenshot shows the 'Atmel Start Importer' dialog box titled 'New Atmel Start Project'. The dialog has a light blue header with a close button (X) in the top right corner. Below the header is a decorative graphic of colorful 3D blocks. The main area contains four input fields: 'Project Name' with the text 'SecureProject', 'Location' with the path 'C:\SAML11_GettingStarted_TZ_Example_Folder' and a 'Browse' button to its right, 'Solution' with a dropdown menu showing 'Create New Solution', and 'Solution Name' with the text 'TrustZoneGettingStarted'. A 'View Project Summary' link is located below the 'Solution Name' field. At the bottom of the dialog are 'OK' and 'Cancel' buttons.

10. To see the project in the Atmel Studio Solution Explorer: *View > Solution Explorer* or <CTRL+ALT+L>.

Figure 5-8. Atmel Studio Solution Explorer Showing Secure Project

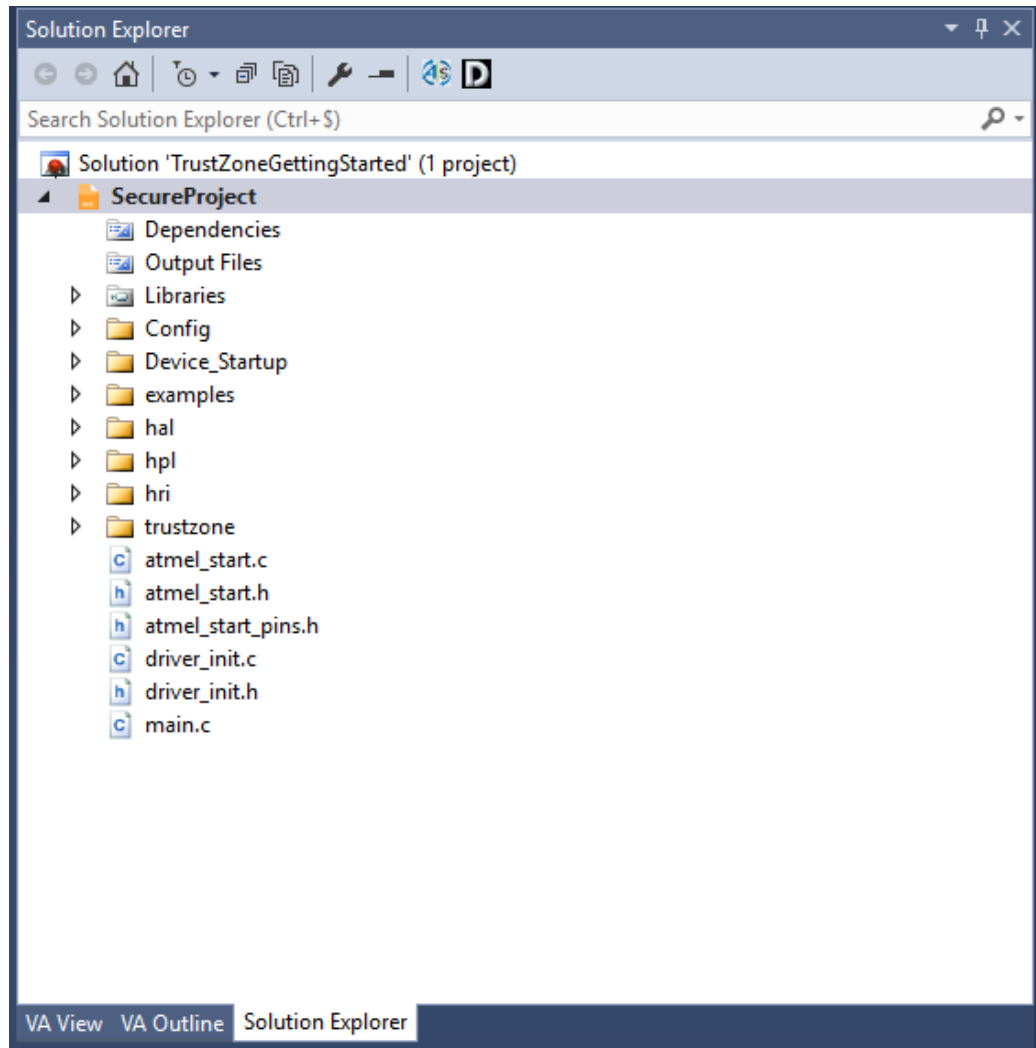

Currently, the TrustZoneGettingStarted solution is only composed of the *SecureProject*.

11. To compile the "TrustZoneGettingStarted " Secure application, build the project: *Build > Build Solution* or <F7 >..

The current building of the project is important as it enables the generation of the Secure library gateway used in the future Non-Secure application.

Figure 5-9. Secure Project Building Output Window

```
Output
Show output from: Build
C:\Program Files (x86)\Atmel\Studio\7.0\Vs\Avr.common.targets(100,5) : message : all jobs completed. Output byte
make: Nothing to be done for 'all'.
Done executing task "RunCompilerTask".
Task "RunOutputFileVerifyTask"
    Program Memory Usage : 1220 bytes 1.8 % Full
    Data Memory Usage : 1568 bytes 9.6 % Full
Done executing task "RunOutputFileVerifyTask".
Done building target "CoreBuild" in project "SecureProject.cproj".
Target "PostBuildEvent" skipped, due to false condition; ('$(PostBuildEvent)' != '') was evaluated as ('' != '').
Target "Build" in file "C:\Program Files (x86)\Atmel\Studio\7.0\Vs\Avr.common.targets" from project "C:\SAML11_GettingStarted_TZ_Examp
Done building target "Build" in project "SecureProject.cproj".
Done building project "SecureProject.cproj".

Build succeeded.
==== Build: 1 succeeded or up-to-date, 0 failed, 0 skipped =====
|
Output
Build succeeded
```

The Secure Application is built, and the Secure library gateway has been generated in the *SecureProject /Debug* folder:

Figure 5-10. Compilation Resulting Secure Library File

The screenshot shows a file explorer window with the following path: `ed_TZ_Example_Folder > TrustZoneGettingStarted > SecureProject > Debug`. The window contains a search bar labeled "Search Debug" and a table of files and folders.

Name	Date modified	Type	Size
Config	5/25/2018 10:32 AM	File folder	
Device_Startup	5/25/2018 10:56 AM	File folder	
examples	5/25/2018 10:56 AM	File folder	
hal	5/25/2018 10:32 AM	File folder	
hpl	5/25/2018 10:32 AM	File folder	
hri	5/25/2018 10:32 AM	File folder	
trustzone	5/25/2018 10:56 AM	File folder	
atmel_start.d	5/25/2018 10:56 AM	D File	19 KB
atmel_start.o	5/25/2018 10:56 AM	O File	728 KB
driver_init.d	5/25/2018 10:56 AM	D File	18 KB
driver_init.o	5/25/2018 10:56 AM	O File	712 KB
libsecure_gateway_veneer.lib	5/25/2018 10:56 AM	Altium Library	1 KB
main.d	5/25/2018 10:56 AM	D File	19 KB
main.o	5/25/2018 10:56 AM	O File	725 KB
makedep.mk	5/25/2018 10:32 AM	MK File	1 KB
Makefile	5/25/2018 10:56 AM	File	31 KB
SecureProject.bin	5/25/2018 10:56 AM	BIN File	8,209 KB
SecureProject.eep	5/25/2018 10:56 AM	EEP File	0 KB
SecureProject.elf	5/25/2018 10:56 AM	ELF File	833 KB
SecureProject.hex	5/25/2018 10:56 AM	HEX File	4 KB
SecureProject.lss	5/25/2018 10:56 AM	LSS File	24 KB
SecureProject.map	5/25/2018 10:56 AM	MAP File	432 KB
SecureProject.srec	5/25/2018 10:56 AM	SREC File	4 KB

12. Close the Atmel Start window from Atmel Studio.
13. Reopen a new Atmel Start Example Project to create the Non-Secure application:
 - *File > New > Atmel Start Example Project.*
 - Open Atmel START directly into Atmel Studio 7.

Figure 5-11. Open a New Atmel Start Example Project in Atmel Studio

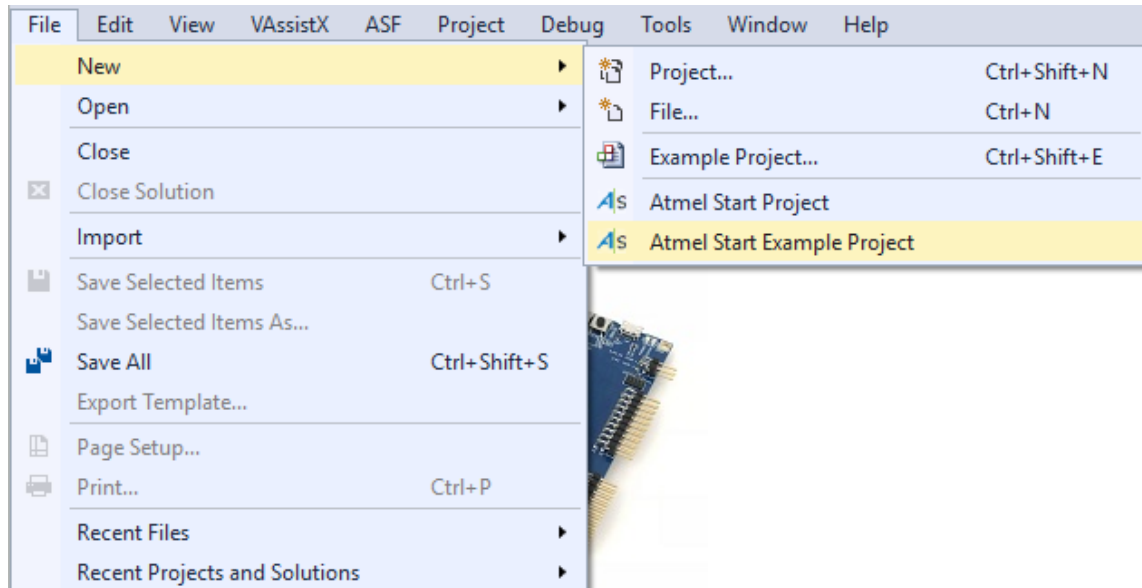

14. Choose the "TrustZone Getting Started Example" for the Non-Secure Project (TZ-GetStart-NS) from the existing examples list, and then click **OPEN SELECTED EXAMPLE**.

Figure 5-12. TrustZone Getting started SAM L11 Non-Secure Project Example Selection

Search: Category: Board:

Name	Categories	Description	Board(s) supported	User guide
PWM Example		This demo read light sensor on IO Xplained over ADC, and then output PWM on LED to reflect the current measured light level.	SAM L10 Xplained Pro SAM L11 Xplained Pro	User guide
Smart Card Example		This example does a read and write data example for smart card.	SAM L10 Xplained Pro SAM L11 Xplained Pro	User guide
TZ-GetStart-NS		Getting started example of using TrustZone for Cortex-M device. This is non-secure project, please use it together with secure project.	SAM L11 Xplained Pro	User guide
TZ-GetStart-S		Getting started example of using TrustZone for Cortex-M device. This is secure project, please use it together with non-secure project.	SAM L11 Xplained Pro	User guide
TZ-MixSecureEIC-NS		This example illustrates the use of TrustZone for Cortex-M device of mix secure peripheral EIC. This is non-secure project, please use it together with secure project.	SAM L11 Xplained Pro	User guide
TZ-MixSecureEIC-S		This example illustrates the use of TrustZone for Cortex-M device of mix secure peripheral EIC. This is secure project, please use it together with non-secure project.	SAM L11 Xplained Pro	User guide
TZ-SecureDriver-NS		This example illustrates the use of TrustZone for Cortex-M device by isolating temperature sensor driver source code from non-secure world. This is non-secure project, please use it together with secure project.	SAM L11 Xplained Pro	User guide
TZ-SecureDriver-S		This example illustrates the use of TrustZone for Cortex-M device by isolating temperature sensor driver source code from non-secure world. This is secure project, please use it together with non-secure project.	SAM L11 Xplained Pro	User guide

Showing 19 of 19 examples.

OPEN SELECTED EXAMPLE

15. Generate the project from Atmel Start to open it in Atmel Studio, and once it is loaded, click **GENERATE PROJECT**.

Figure 5-13. Atmel Start Non-Secure Project Overview and Generation

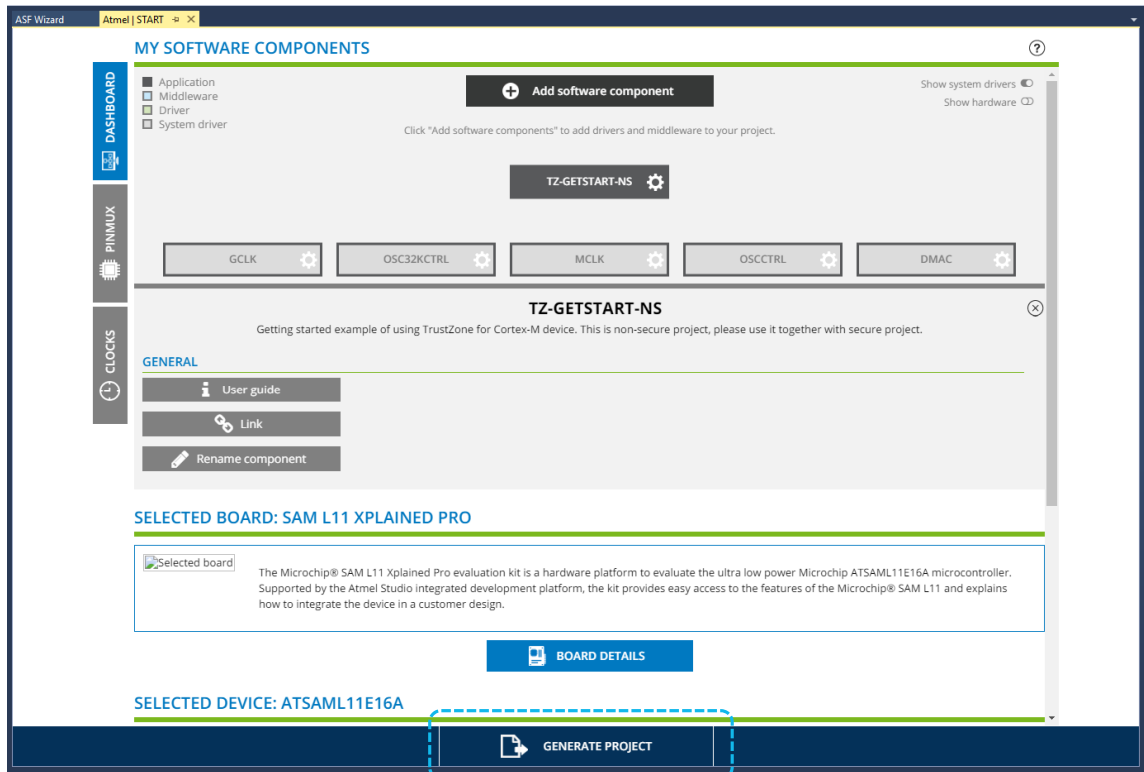

16. The following "New Atmel Start Project " window will be displayed.

Figure 5-14. Non-Secure Project Importation Window

Atmel Start Importer

New Atmel Start Project

Project Name:

Location:

Solution:

Solution Name:

Non-secure SAML11 project is detected, Please select below files and proceed

Secure Project Veneer Header File:

Secure Project Export Library:

Non-Secure Project Linker Script:

17. Modify the project information as given below:

Figure 5-15. New Atmel Start Project

- Project Name: rename the project name to "NonSecure Project".
- Location: keep the same location as the Secure Application Project.
- Solution: Add to Solution.
- Solution Name: Keep the same Solution name used for the Secure Project: *TrustZoneGettingStarted*.
- Ensure that you **Do not click the OK button** now.



Important: Make sure to select the adding option by clicking *Add As Link*.

Users need to complete these steps for the Non-Secure Project importation:

- Add the Secure Project Veneer Header file required to add the veneer functions used to communicate between the Secure application and the Non-Secure application. The Secure Project Veneer Header file is located in the *SecureProjectFolder/trustzone* folder. In this example this file is called `trustzone_veneer.h`.
- Add the Secure Project Export Library file required to add the compiled library containing the secure functions used to communicate between the Secure application and the Non-Secure application. The Secure Project Export Library file is located in the *SecureProjectFolder/debug* folder. In this example, this file is called `libsecure_gateway_veneer.lib`.
- Add the *Non-Secure Project Linker Script* file required to manage the memory allocation (Non-Secure and Secure parts) for the Application Programming. The Non-Secure Project Linker Script file is located in the *SecureProjectFolder/Device_Startup* folder. In this example this file is called `saml11_nonsecure.ld`.

Figure 5-16. New Atmel Start Project Window

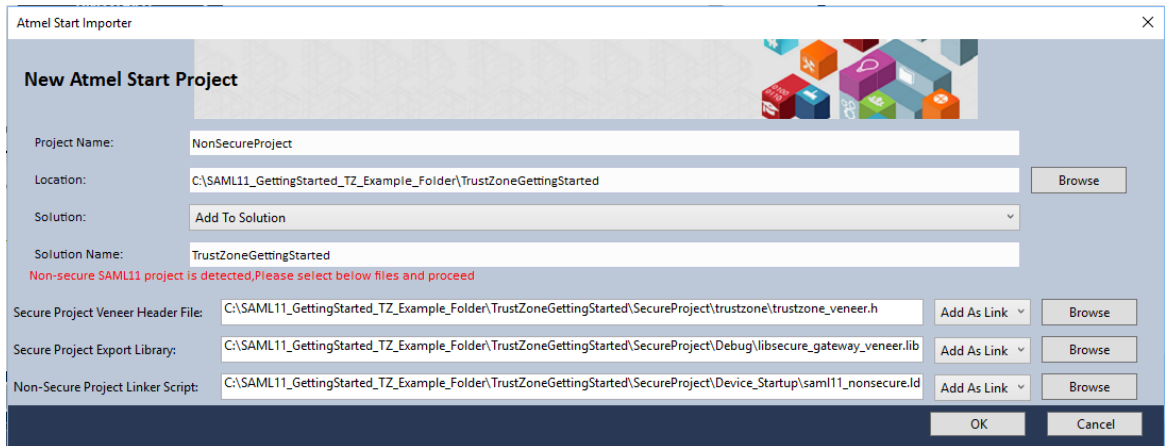

The screenshot shows the 'Atmel Start Importer' dialog box with the title 'New Atmel Start Project'. The dialog contains the following fields and options:

- Project Name:** NonSecureProject
- Location:** C:\SAML11_GettingStarted_TZ_Example_Folder\TrustZoneGettingStarted (with a 'Browse' button)
- Solution:** Add To Solution (dropdown menu)
- Solution Name:** TrustZoneGettingStarted

A red warning message is displayed: "Non-secure SAML11 project is detected, Please select below files and proceed".

Below the warning, there are three rows of file selection options, each with an 'Add As Link' dropdown and a 'Browse' button:

- Secure Project Veneer Header File:** C:\SAML11_GettingStarted_TZ_Example_Folder\TrustZoneGettingStarted\SecureProject\trustzone\trustzone_veneer.h
- Secure Project Export Library:** C:\SAML11_GettingStarted_TZ_Example_Folder\TrustZoneGettingStarted\SecureProject\Debug\libsecure_gateway_veneer.lib
- Non-Secure Project Linker Script:** C:\SAML11_GettingStarted_TZ_Example_Folder\TrustZoneGettingStarted\SecureProject\Device_Startup\saml11_nonsecure.ld

At the bottom right, there are 'OK' and 'Cancel' buttons.

- Click **OK** to open the project in Atmel Studio.

18. To see this project using the Atmel Studio Solution Explorer, select *View/Solution Explorer* or press <CTRL+ALT+L>.

The Solution TrustZoneGettingStarted is now composed of these two projects. These two projects are shown in the following figure.

- **SecureProject**
- **NonSecureProject**

Figure 5-17. Atmel Studio Solution Explorer Showing both Secure and Non-Secure Project

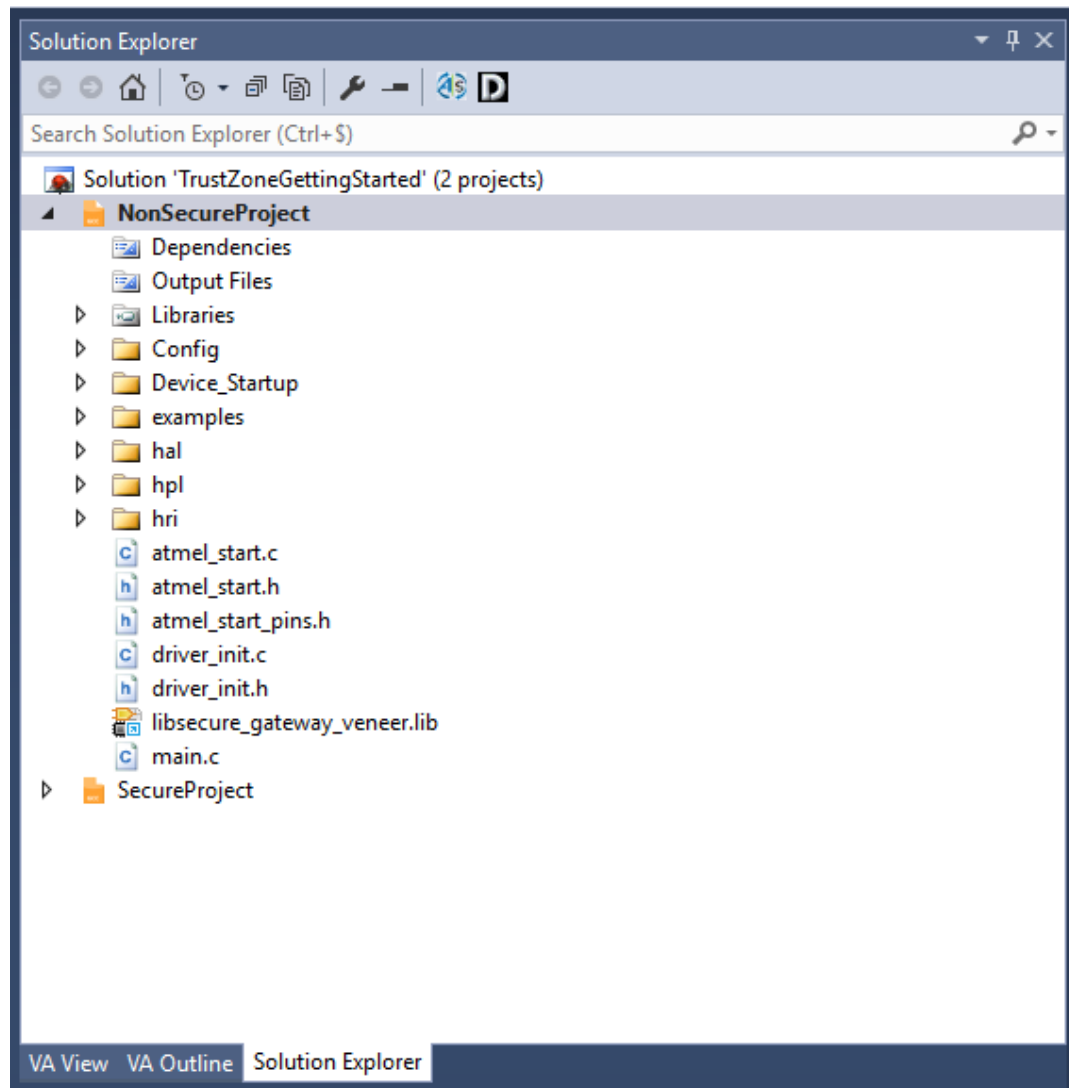

19. Configure the Non-Secure project debugger/programmer interface. Open the project properties and then perform this action: *Project > Properties* or press <ALT+F7>.
20. Click **Tool**.
 - For the Selected debugger/programmer chose "EDBG ATMLxxx".
 - For the Interface choose "SWD".

Figure 5-18. Programming Tool Selection for the Non-Secure Project

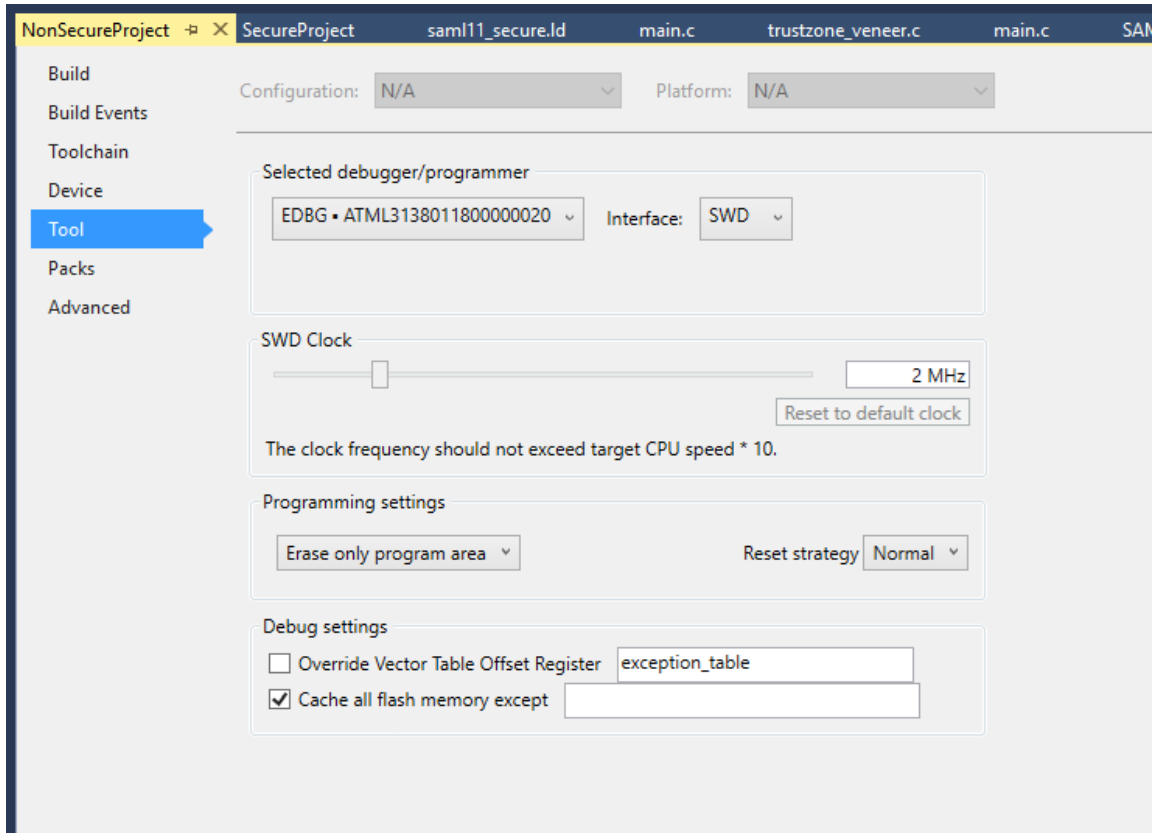

21. Compile the NonSecureProject: To build the project: *Build > Build Solution* or press <F7>. Check and verify that no errors are reported.

Figure 5-19. Non-Secure Project Building Output Window

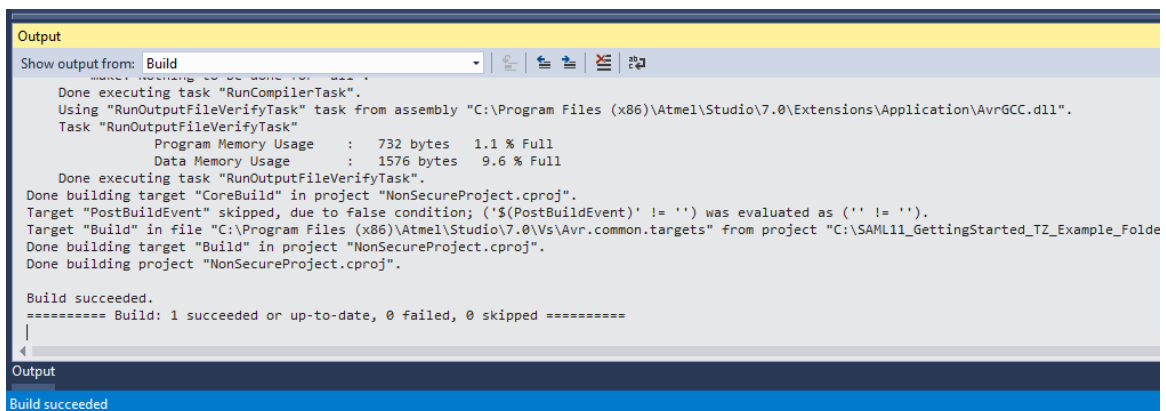

22. Configure the SecureProject and NonSecureProject for cross-debugging.
 - From the Solution Explorer Window, right-click on the *SecureProject* file and choose properties.

Figure 5-20. How to access Project Properties in Atmel Studio

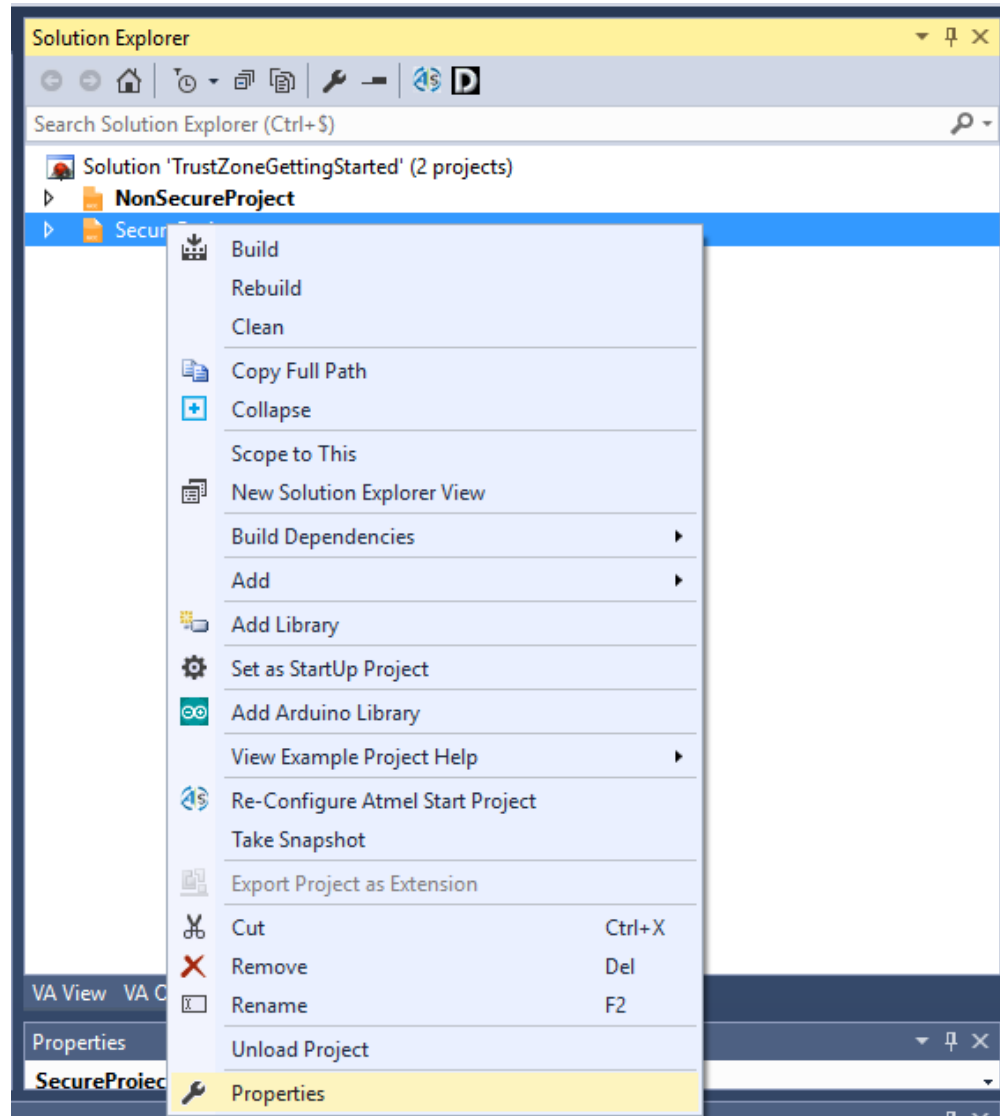

- From the SecureProject Properties Window, click **Advanced**.

Figure 5-21. Advanced Project Properties Tab

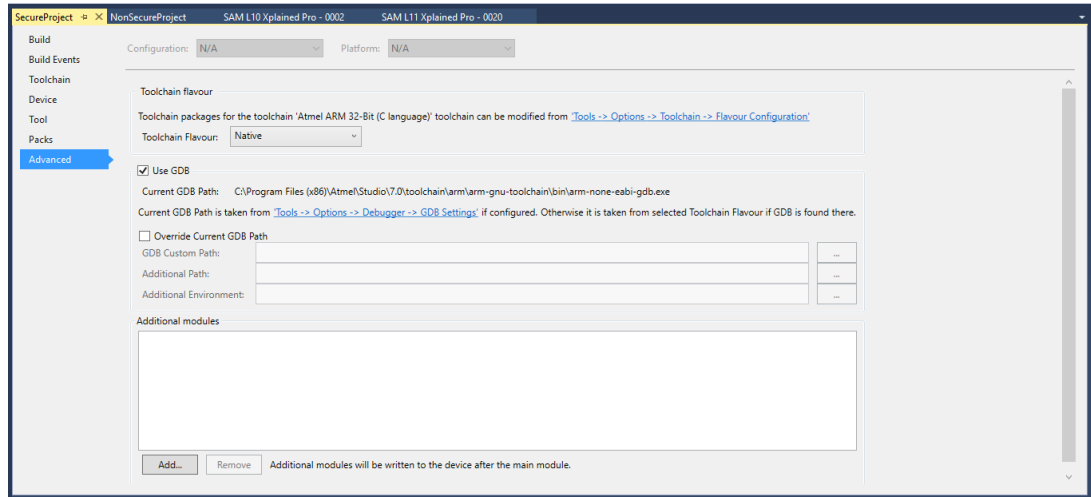

- Click **Add** to add the *NonSecureProject.elf* file to the SecureProject additional modules. The *NonSecureProject.elf* is a compiled file located in the *NonSecureProjectFolder/Debug* folder.

Figure 5-22. .elf File Selection

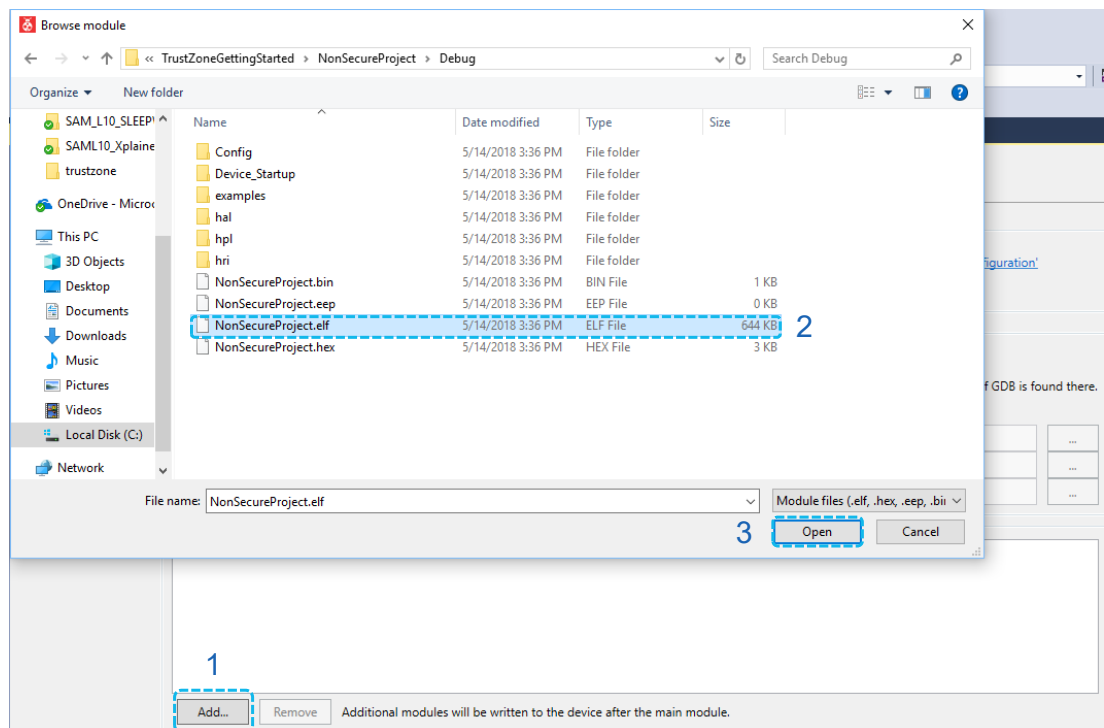

The *NonSecureProject.elf* file now accesses part of the SecureProject additional modules as shown:

Figure 5-23. NonSecureProject Properties Window

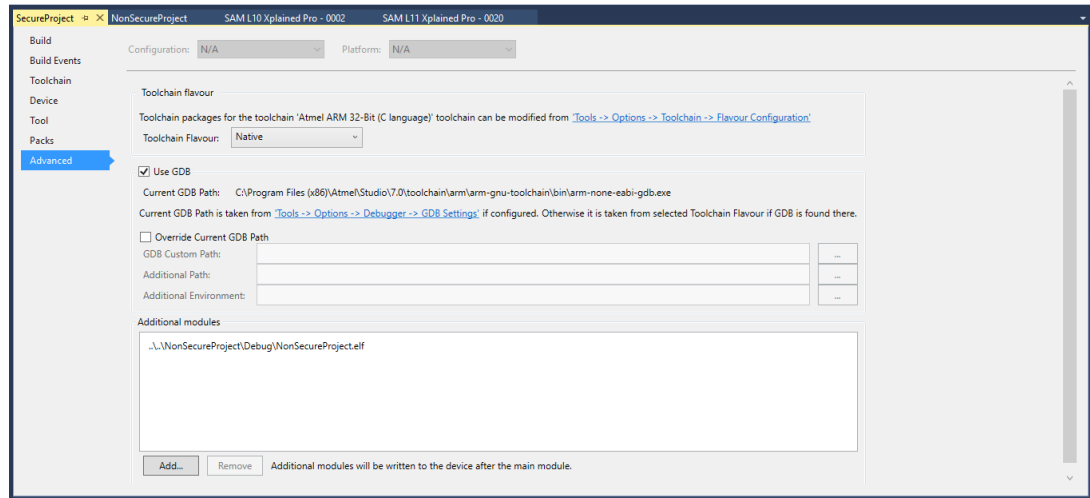

- To complete this step, save current properties: *File > SaveSecureProject*.
- From the Solution Explorer window, right-click on the *NonSecureProject* file and choose *Properties*.
- From the NonSecureProject Properties, click **Advanced**.
- Click **Add** to add the *SecureProject.elf* file to the NonSecureProject additional modules.
Note: The *SecureProject.elf* is a compiled file located in the *SecureProjectFolder/debug* folder. The *SecureProject.elf* file becomes an accesses part of the SecureProject additional modules as described:

Figure 5-24. NonSecureProject Properties Window

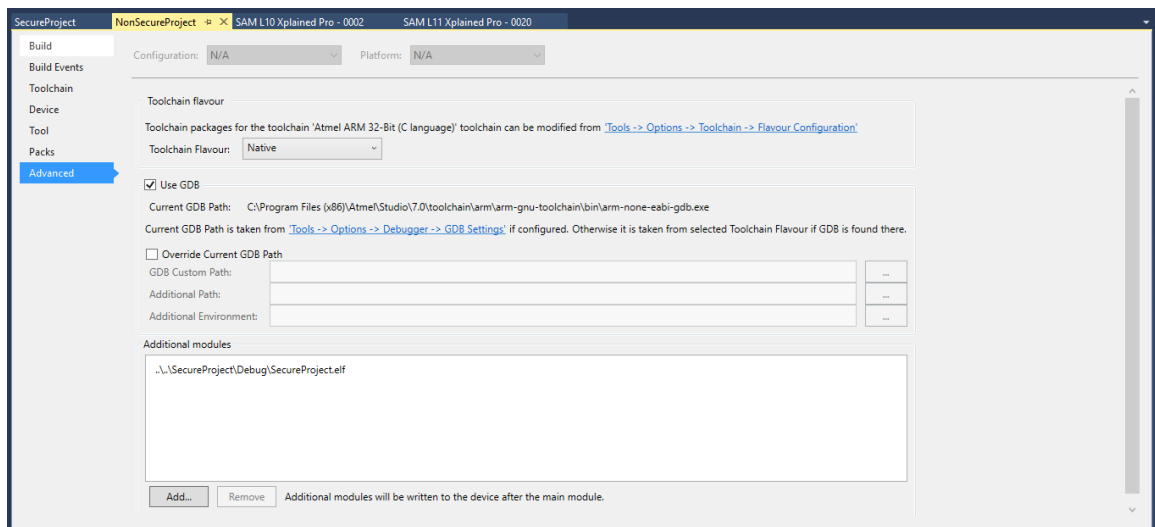

- To complete this step, save current properties by doing this action: *File > SaveSecureProject*.

23. To set Breakpoints to debug the complete TrustZone Solution, follow these steps:
- Set a break point in the *NonSecure Project*.
 - Deploy the *NonSecureProject* file in the Solution Explorer Window, and open the *main.c* file.
 - Double-click on the related line to add the breakpoint.

Figure 5-25. Atmel Studio IDE Overview: Break Point Location

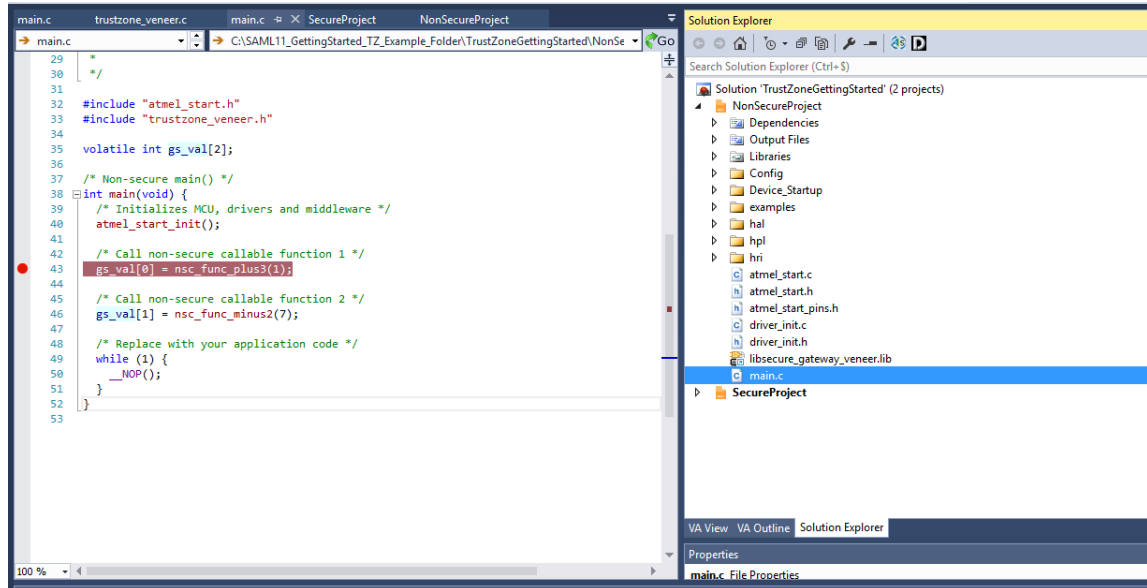

In this case, the breakpoint is placed at the line that calls the Non-Secure callable function1, `nsc_func_plus3`. This function is declared into the `libsecure_gateway_veneer.lib` file, which is generated once the `SecureProject` is built.

The call to the secure function, `func_plus3`, is done in the veneer (`Secure Gateway`), and the declaration is done in the `main.c` file of the `SecureProject`.

- Set a breakpoint into the `Secure gateway` `trustzone_veneer.c` file, at the return `func_plus3(x);` line.

Figure 5-26. Atmel Studio IDE Overview: Break Point Hit in the Secure Gateway Veneer

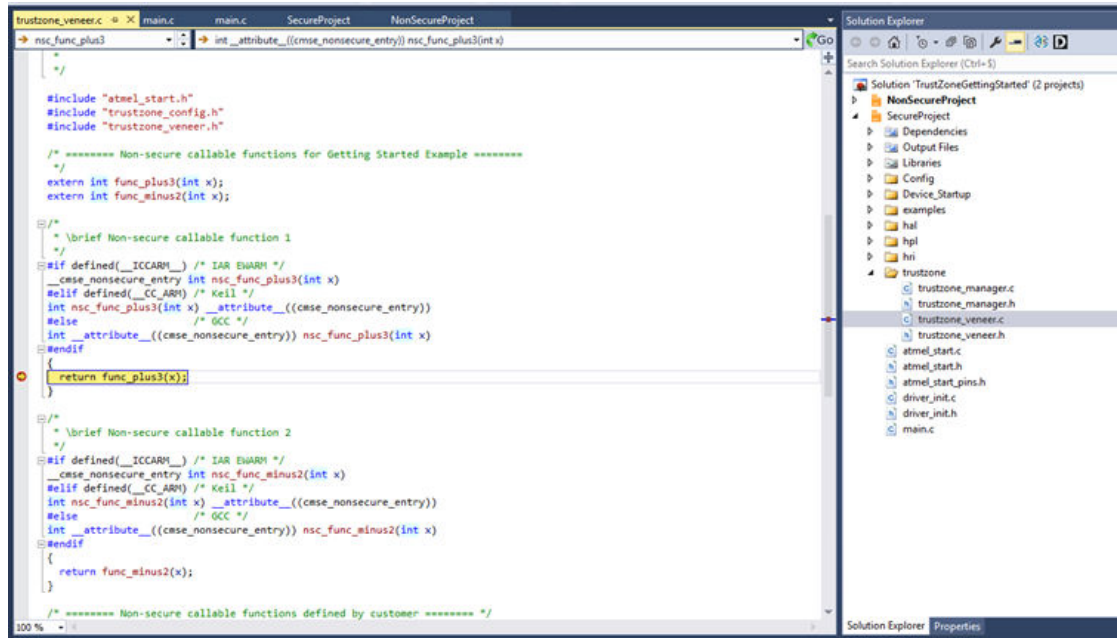

- Set a breakpoint into the SecureProject `main.c` file at the `func_plus3` declaration.

Figure 5-27. Atmel Studio IDE Overview: Breakpoint Hit in the Secure Project

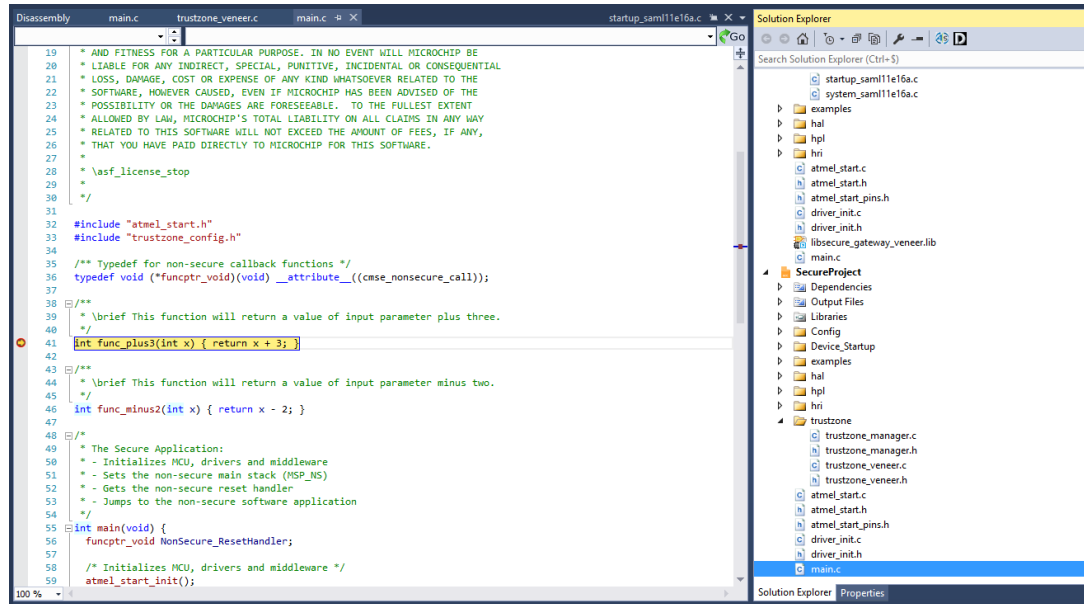

- Debug your project and see the breakpoint hit in the Non-Secure project, then in the Secure project follow these steps:
 - Click  or press <F5> to start and execute a new debug session. The execution halts at the first breakpoint located in the NonSecureProject.

Figure 5-28. Debug Session Window



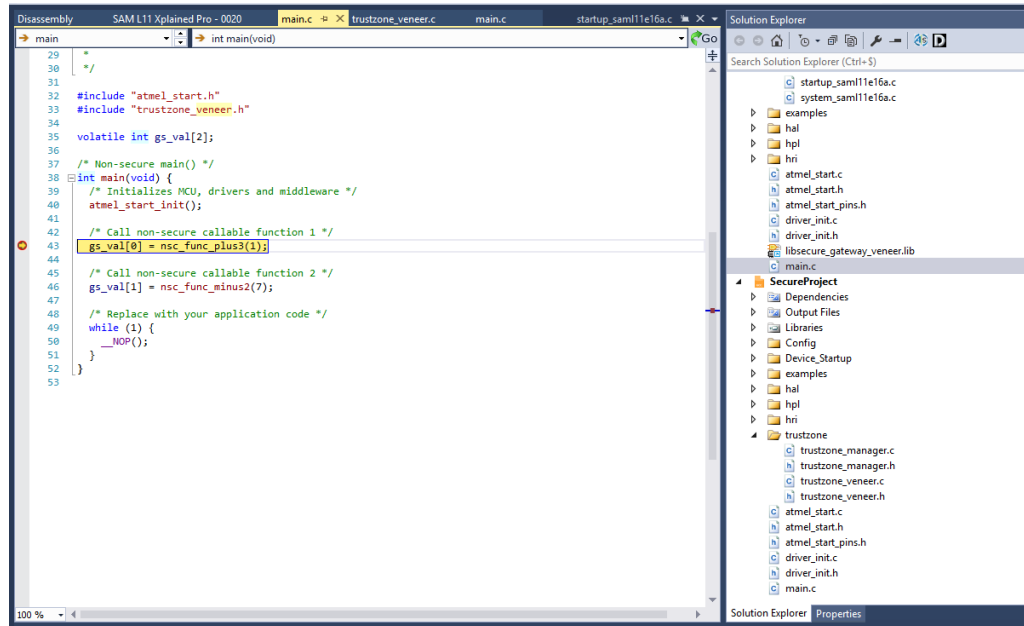

- Click  again or press < F5> to continue the debug the session. The execution halts at the second breakpoint located in the Secure gateway (trustzone_veneer.c).
- Click  again or press < F5> to continue the debug the session. The execution halts at the third breakpoint located in the SecureProject.

Figure 5-29. Debug Session Window



Note: Now both the Secure and Non-Secure projects can be debugged without any restrictions.

The Microchip Web Site

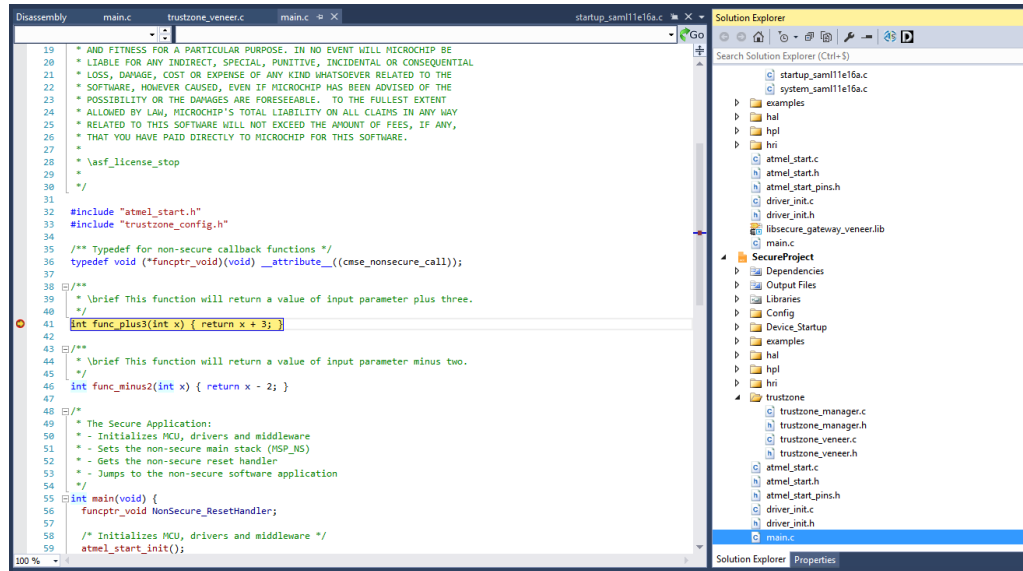
Microchip provides online support via our web site at <http://www.microchip.com/>. This web site is used as a means to make files and information easily available to customers. Accessible by using your favorite Internet browser, the web site contains the following information:

- **Product Support** – Data sheets and errata, application notes and sample programs, design resources, user's guides and hardware support documents, latest software releases and archived software
- **General Technical Support** – Frequently Asked Questions (FAQ), technical support requests, online discussion groups, Microchip consultant program member listing
- **Business of Microchip** – Product selector and ordering guides, latest Microchip press releases, listing of seminars and events, listings of Microchip sales offices, distributors and factory representatives

Customer Change Notification Service

Microchip's customer notification service helps keep customers current on Microchip products. Subscribers will receive e-mail notification whenever there are changes, updates, revisions or errata related to a specified product family or development tool of interest.

To register, access the Microchip web site at <http://www.microchip.com/>. Under "Support", click on "Customer Change Notification" and follow the registration instructions.

Customer Support

Users of Microchip products can receive assistance through several channels:

- Distributor or Representative
- Local Sales Office
- Field Application Engineer (FAE)
- Technical Support

Customers should contact their distributor, representative or Field Application Engineer (FAE) for support. Local sales offices are also available to help customers. A listing of sales offices and locations is included in the back of this document.

Technical support is available through the web site at: <http://www.microchip.com/support>

Microchip Devices Code Protection Feature

Note the following details of the code protection feature on Microchip devices:

- Microchip products meet the specification contained in their particular Microchip Data Sheet.
- Microchip believes that its family of products is one of the most secure families of its kind on the market today, when used in the intended manner and under normal conditions.
- There are dishonest and possibly illegal methods used to breach the code protection feature. All of these methods, to our knowledge, require using the Microchip products in a manner outside the operating specifications contained in Microchip's Data Sheets. Most likely, the person doing so is engaged in theft of intellectual property.
- Microchip is willing to work with the customer who is concerned about the integrity of their code.

- Neither Microchip nor any other semiconductor manufacturer can guarantee the security of their code. Code protection does not mean that we are guaranteeing the product as “unbreakable.”

Code protection is constantly evolving. We at Microchip are committed to continuously improving the code protection features of our products. Attempts to break Microchip’s code protection feature may be a violation of the Digital Millennium Copyright Act. If such acts allow unauthorized access to your software or other copyrighted work, you may have a right to sue for relief under that Act.

Legal Notice

Information contained in this publication regarding device applications and the like is provided only for your convenience and may be superseded by updates. It is your responsibility to ensure that your application meets with your specifications. MICROCHIP MAKES NO REPRESENTATIONS OR WARRANTIES OF ANY KIND WHETHER EXPRESS OR IMPLIED, WRITTEN OR ORAL, STATUTORY OR OTHERWISE, RELATED TO THE INFORMATION, INCLUDING BUT NOT LIMITED TO ITS CONDITION, QUALITY, PERFORMANCE, MERCHANTABILITY OR FITNESS FOR PURPOSE. Microchip disclaims all liability arising from this information and its use. Use of Microchip devices in life support and/or safety applications is entirely at the buyer’s risk, and the buyer agrees to defend, indemnify and hold harmless Microchip from any and all damages, claims, suits, or expenses resulting from such use. No licenses are conveyed, implicitly or otherwise, under any Microchip intellectual property rights unless otherwise stated.

Trademarks

The Microchip name and logo, the Microchip logo, AnyRate, AVR, AVR logo, AVR Freaks, BeaconThings, BitCloud, CryptoMemory, CryptoRF, dsPIC, FlashFlex, flexPWR, Heldo, JukeBlox, KeeLoq, KeeLoq logo, Kleer, LANCheck, LINK MD, maXStylus, maXTouch, MediaLB, megaAVR, MOST, MOST logo, MPLAB, OptoLyzer, PIC, picoPower, PICSTART, PIC32 logo, Prochip Designer, QTouch, RightTouch, SAM-BA, SpyNIC, SST, SST Logo, SuperFlash, tinyAVR, UNI/O, and XMEGA are registered trademarks of Microchip Technology Incorporated in the U.S.A. and other countries.

ClockWorks, The Embedded Control Solutions Company, EtherSynch, Hyper Speed Control, HyperLight Load, IntelliMOS, mTouch, Precision Edge, and Quiet-Wire are registered trademarks of Microchip Technology Incorporated in the U.S.A.

Adjacent Key Suppression, AKS, Analog-for-the-Digital Age, Any Capacitor, AnyIn, AnyOut, BodyCom, chipKIT, chipKIT logo, CodeGuard, CryptoAuthentication, CryptoCompanion, CryptoController, dsPICDEM, dsPICDEM.net, Dynamic Average Matching, DAM, ECAN, EtherGREEN, In-Circuit Serial Programming, ICSP, Inter-Chip Connectivity, JitterBlocker, KleerNet, KleerNet logo, Mindi, MiWi, motorBench, MPASM, MPF, MPLAB Certified logo, MPLIB, MPLINK, MultiTRAK, NetDetach, Omniscient Code Generation, PICDEM, PICDEM.net, PICKit, PICtail, PureSilicon, QMatrix, RightTouch logo, REAL ICE, Ripple Blocker, SAM-ICE, Serial Quad I/O, SMART-I.S., SQI, SuperSwitcher, SuperSwitcher II, Total Endurance, TSHARC, USBCheck, VariSense, ViewSpan, WiperLock, Wireless DNA, and ZENA are trademarks of Microchip Technology Incorporated in the U.S.A. and other countries.

SQTP is a service mark of Microchip Technology Incorporated in the U.S.A.

Silicon Storage Technology is a registered trademark of Microchip Technology Inc. in other countries.

GestIC is a registered trademark of Microchip Technology Germany II GmbH & Co. KG, a subsidiary of Microchip Technology Inc., in other countries.

All other trademarks mentioned herein are property of their respective companies.

© 2018, Microchip Technology Incorporated, Printed in the U.S.A., All Rights Reserved.

ISBN: 978-1-5224-3235-7

Quality Management System Certified by DNV

ISO/TS 16949

Microchip received ISO/TS-16949:2009 certification for its worldwide headquarters, design and wafer fabrication facilities in Chandler and Tempe, Arizona; Gresham, Oregon and design centers in California and India. The Company's quality system processes and procedures are for its PIC[®] MCUs and dsPIC[®] DSCs, KEELOQ[®] code hopping devices, Serial EEPROMs, microperipherals, nonvolatile memory and analog products. In addition, Microchip's quality system for the design and manufacture of development systems is ISO 9001:2000 certified.

Worldwide Sales and Service

AMERICAS	ASIA/PACIFIC	ASIA/PACIFIC	EUROPE
<p>Corporate Office 2355 West Chandler Blvd. Chandler, AZ 85224-6199 Tel: 480-792-7200 Fax: 480-792-7277 Technical Support: http://www.microchip.com/support Web Address: www.microchip.com</p> <p>Atlanta Duluth, GA Tel: 678-957-9614 Fax: 678-957-1455</p> <p>Austin, TX Tel: 512-257-3370</p> <p>Boston Westborough, MA Tel: 774-760-0087 Fax: 774-760-0088</p> <p>Chicago Itasca, IL Tel: 630-285-0071 Fax: 630-285-0075</p> <p>Dallas Addison, TX Tel: 972-818-7423 Fax: 972-818-2924</p> <p>Detroit Novi, MI Tel: 248-848-4000</p> <p>Houston, TX Tel: 281-894-5983</p> <p>Indianapolis Noblesville, IN Tel: 317-773-8323 Fax: 317-773-5453 Tel: 317-536-2380</p> <p>Los Angeles Mission Viejo, CA Tel: 949-462-9523 Fax: 949-462-9608 Tel: 951-273-7800</p> <p>Raleigh, NC Tel: 919-844-7510</p> <p>New York, NY Tel: 631-435-6000</p> <p>San Jose, CA Tel: 408-735-9110 Tel: 408-436-4270</p> <p>Canada - Toronto Tel: 905-695-1980 Fax: 905-695-2078</p>	<p>Australia - Sydney Tel: 61-2-9868-6733</p> <p>China - Beijing Tel: 86-10-8569-7000</p> <p>China - Chengdu Tel: 86-28-8665-5511</p> <p>China - Chongqing Tel: 86-23-8980-9588</p> <p>China - Dongguan Tel: 86-769-8702-9880</p> <p>China - Guangzhou Tel: 86-20-8755-8029</p> <p>China - Hangzhou Tel: 86-571-8792-8115</p> <p>China - Hong Kong SAR Tel: 852-2943-5100</p> <p>China - Nanjing Tel: 86-25-8473-2460</p> <p>China - Qingdao Tel: 86-532-8502-7355</p> <p>China - Shanghai Tel: 86-21-3326-8000</p> <p>China - Shenyang Tel: 86-24-2334-2829</p> <p>China - Shenzhen Tel: 86-755-8864-2200</p> <p>China - Suzhou Tel: 86-186-6233-1526</p> <p>China - Wuhan Tel: 86-27-5980-5300</p> <p>China - Xian Tel: 86-29-8833-7252</p> <p>China - Xiamen Tel: 86-592-2388138</p> <p>China - Zhuhai Tel: 86-756-3210040</p>	<p>India - Bangalore Tel: 91-80-3090-4444</p> <p>India - New Delhi Tel: 91-11-4160-8631</p> <p>India - Pune Tel: 91-20-4121-0141</p> <p>Japan - Osaka Tel: 81-6-6152-7160</p> <p>Japan - Tokyo Tel: 81-3-6880-3770</p> <p>Korea - Daegu Tel: 82-53-744-4301</p> <p>Korea - Seoul Tel: 82-2-554-7200</p> <p>Malaysia - Kuala Lumpur Tel: 60-3-7651-7906</p> <p>Malaysia - Penang Tel: 60-4-227-8870</p> <p>Philippines - Manila Tel: 63-2-634-9065</p> <p>Singapore Tel: 65-6334-8870</p> <p>Taiwan - Hsin Chu Tel: 886-3-577-8366</p> <p>Taiwan - Kaohsiung Tel: 886-7-213-7830</p> <p>Taiwan - Taipei Tel: 886-2-2508-8600</p> <p>Thailand - Bangkok Tel: 66-2-694-1351</p> <p>Vietnam - Ho Chi Minh Tel: 84-28-5448-2100</p>	<p>Austria - Wels Tel: 43-7242-2244-39 Fax: 43-7242-2244-393</p> <p>Denmark - Copenhagen Tel: 45-4450-2828 Fax: 45-4485-2829</p> <p>Finland - Espoo Tel: 358-9-4520-820</p> <p>France - Paris Tel: 33-1-69-53-63-20 Fax: 33-1-69-30-90-79</p> <p>Germany - Garching Tel: 49-8931-9700</p> <p>Germany - Haan Tel: 49-2129-3766400</p> <p>Germany - Heilbronn Tel: 49-7131-67-3636</p> <p>Germany - Karlsruhe Tel: 49-721-625370</p> <p>Germany - Munich Tel: 49-89-627-144-0 Fax: 49-89-627-144-44</p> <p>Germany - Rosenheim Tel: 49-8031-354-560</p> <p>Israel - Ra'anana Tel: 972-9-744-7705</p> <p>Italy - Milan Tel: 39-0331-742611 Fax: 39-0331-466781</p> <p>Italy - Padova Tel: 39-049-7625286</p> <p>Netherlands - Drunen Tel: 31-416-690399 Fax: 31-416-690340</p> <p>Norway - Trondheim Tel: 47-7289-7561</p> <p>Poland - Warsaw Tel: 48-22-3325737</p> <p>Romania - Bucharest Tel: 40-21-407-87-50</p> <p>Spain - Madrid Tel: 34-91-708-08-90 Fax: 34-91-708-08-91</p> <p>Sweden - Gothenberg Tel: 46-31-704-60-40</p> <p>Sweden - Stockholm Tel: 46-8-5090-4654</p> <p>UK - Wokingham Tel: 44-118-921-5800 Fax: 44-118-921-5820</p>