

Microcontrollers

2024

12367.6523456789
32163912.9321098765
42738823.921098765
239923.0000000000
2389423.0000000000
329849.0000000000
342728.0000000000
23498234.0240

239923.0000000000
2389423.0000000000
329849.0000000000
342728.0000000000
23498234.0240

239923.0000000000
2389423.0000000000
329849.0000000000
342728.0000000000
23498234.0240
28728782.0302.2290
239923.0000000000
2389423.0000000000
329849.0000000000
342728.0000000000
23498234.0240
28728782.0302.2290
84923.9382456789
209765.7596543210
699489.6989654321
565.59689543210
56907654321098765

2938498243.0390
438043209.03219
84923.9382456789
209765.7596543210
699489.6989654321
565.59689543210
56907654321098765

239923.0000000000
2389423.0000000000
329849.0000000000
342728.0000000000
23498234.0240

239923.0000000000
2389423.0000000000
329849.0000000000
342728.0000000000
23498234.0240

239923.0000000000
2389423.0000000000
329849.0000000000
342728.0000000000
23498234.0240

239923.0000000000
2389423.0000000000
329849.0000000000
342728.0000000000
23498234.0240

Business Concept

The widespread of smartphones and tablets make improvements of broadband and wireless communications, then the advanced information and telecommunications network society has become a reality. In particular, semiconductors for use in portable devices, information terminals, in-vehicle devices and FA devices are expected to provide higher performance in terms of thinner structure, lighter weight, and longer operation with limited power supply. We have been focusing on the creation of compact, low-power semiconductors since we started the development of CMOS LSI for watches in 1969. Since then, we have steadily built up our expertise in energy-saving, space-saving, and time-saving designs. This has enabled us to quickly obtain the semiconductor development technology needed to meet the demands of the new era of the advanced information and telecommunications network society. Our concept is to develop "saving technologies" to reduce power consumption, development times, and implementation space. Our goal is to be a true partner for you, providing you with strategic advantages, enhancing your customer value based on our "saving technologies" and mixed analog/digital technologies that we have cultivated, as well as our design capabilities, manufacturing capabilities and stable supply that can satisfy your detailed requirements.

Environmental Responsibility

Epson semiconductor technology provides environmental value to customers by creating and manufacturing eco-friendly products.

- 1) We Epson's products are surely complying with the Eu-RoHS (2011/65/EU) Directive.
- 2) We are releasing information about the containing chemical substances of products at web-site. Product of QFP & BGA are described in the following URL.
global.epson.com/products_and_drivers/semicon/information/package_lineup.html *Some products are excluded.

Environmental management system third party certification status ISO14001

Type of certification : ISO 14001: 2015, JIS Q 14001: 2015
 Awarded to : TOHOKU EPSON CORPORATION,
 SEIKO EPSON CORPORATION (Fujimi Plant, Suwa Minami Plant)
 Certified by : Bureau Veritas Certification
 Date of certification : April 3, 1999



Type of certification : ISO 14001: 2015
 Awarded to : Singapore Epson Industrial Pte. Ltd.
 Certified by : SGS
 Date of certification : Jan 12, 1999



Epson's Quality Policy

Keeping the customer in mind at all times, we make the quality of our products and services our highest priority. In order to continue to creating products and services that please our customers and earn their trust, Epson's Semiconductor Business has acquired ISO9001 and IATF16949 certification with its IC, module and their application products.

Quality Management system third party certification status ISO9001

Type of Certification : ISO9001: 2015, JIS Q 9001: 2015
 Awarded to : TOHOKU EPSON CORPORATION,
 SEIKO EPSON CORPORATION (Fujimi Plant, Suwa Minami Plant, Tokyo Office, Hirooka Office)
 Certified by : Bureau Veritas Certification
 Initial Date of Certification : October 10, 1993



Type of Certification : ISO9001: 2015
 Awarded to : Singapore Epson Industrial Pte. Ltd.
 Certified by : SGS
 Initial Date of Certification : February 4, 2003

IATF16949

Type of Certification : IATF16949:2016
 Awarded to : TOHOKU EPSON CORPORATION, SEIKO EPSON CORPORATION
 (Fujimi Plant, Tokyo Office, Hirooka Office)
 Epson Europe Electronics GmbH, Epson America Inc.,
 Epson Canada Ltd. (Vancouver Design Center),
 Epson (China) Co., Ltd., Epson Hong Kong Ltd.
 Certified by : Bureau Veritas Certification
 Initial Date of Certification : Dec 9, 2017



Type of Certification : IATF16949:2016
 Awarded to : Singapore Epson Industrial Pte. Ltd.
 Certified by : SGS
 Initial Date of Certification : May 2, 2018

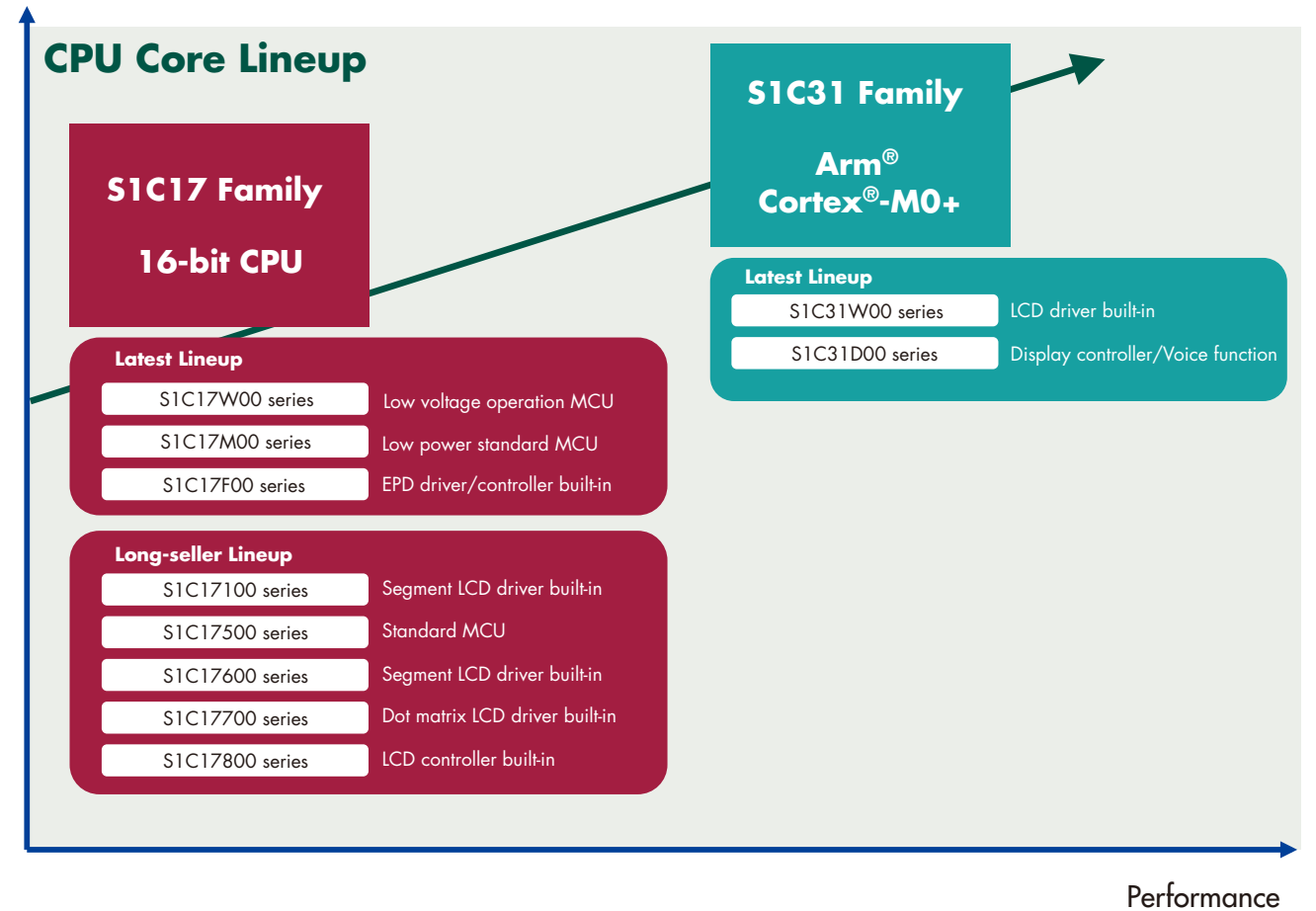

C O N T E N T S

History of Epson semiconductor	4-5	Development environments	20-23
Epson microcontroller overview	6	Flash memory writing	24-25
Features of Epson microcontrollers	7-9	Package lineup	26-27
S1C31 Family Arm® microcontrollers	10-13	Epson MCU website	28-29
S1C17 Family 16-bit microcontrollers	14-19		

History of Epson Semiconductor's Technology

As the semiconductor division of "worldwide watch maker Seiko", semiconductor business has expanded into LCD Drivers, ASICs and MCUs from IC for Watches. These businesses are all based on Epson's energy-saving technology.

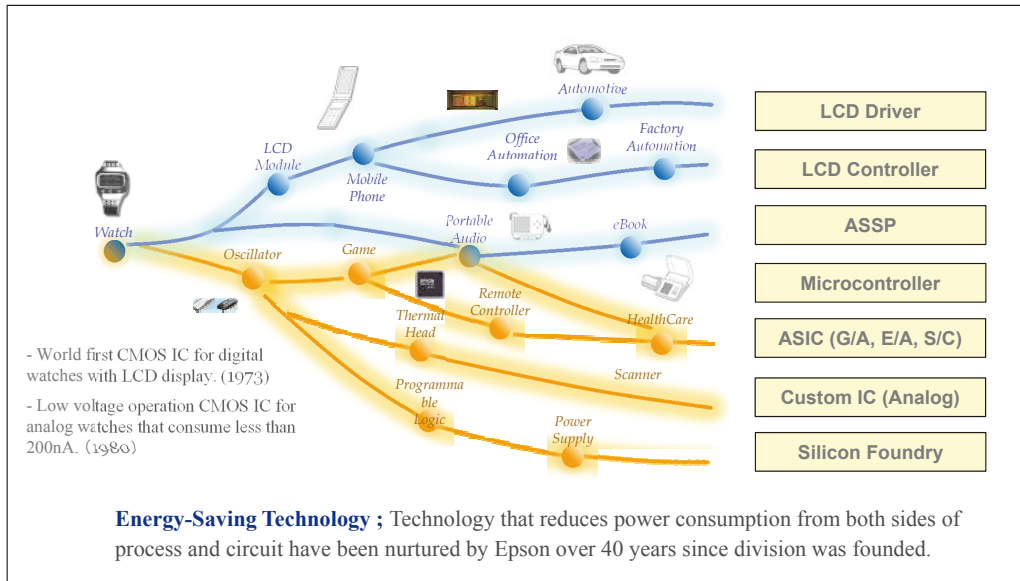

Vision and Target Application

Epson aspires to be a device maker that contributes customers' business by valuable products with our unique core technology

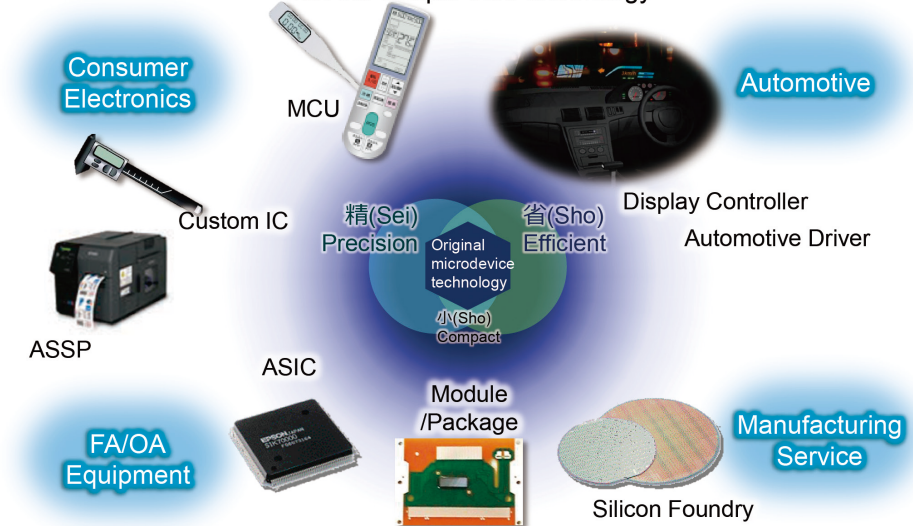

Epson Semiconductor's History



- 1969 Development of CMOS IC for watches started
- 1973 CMOS IC production started in Headquarter
- 1980 Fujimi plant (B-wing, 4 inch) operation started
- 1984 A-wing (5 inch) operation started
- 1985 D-wing (6 inch) operation started
- 1991 Sakata plant (S-wing, 6 inch) operation started
- 1993 ISO9000 series certified
- 1994 Singapore assembly plant (SEP) operation started
- 1997 T-wing (8 inch, Sakata) operation started
- ISO14001 certified
- 2001 T-wing manufacturing line expanded
- 2006 ISO/TS16949 certified
- 2010 Microdevices Operations Division started
- 2017 IATF16949 certified

Epson Product Line-up

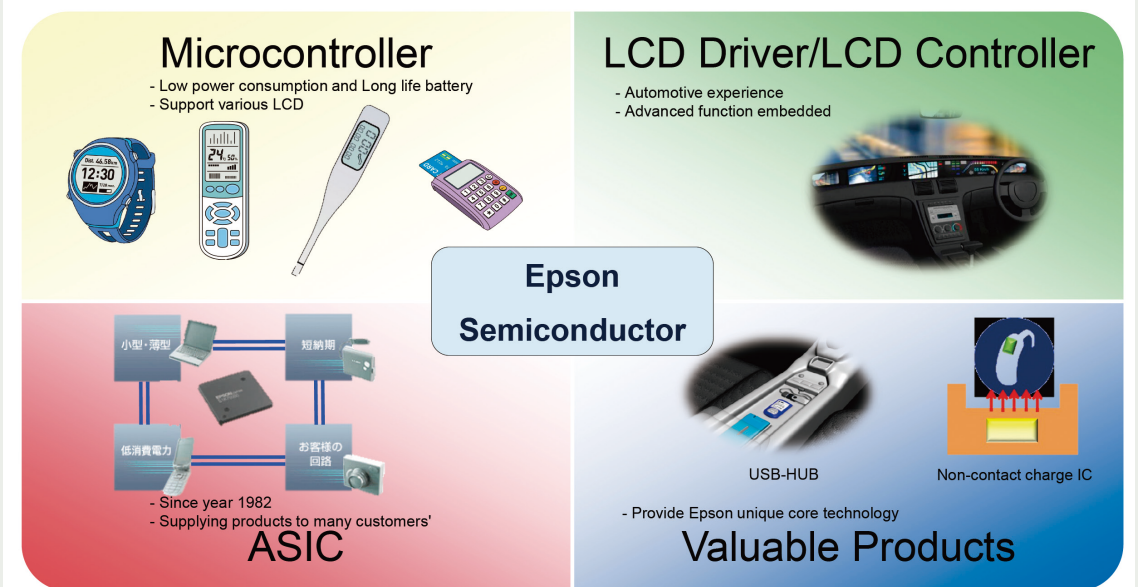

Low power microcontrollers

The technologies of low voltage operation and low power consumption acquired over the years through the development of 4-bit microcontrollers for watches and electronic shelf labels (ESL) are inherited by 16- and 32-bit microcontrollers today. The product lineup has been expanded, while achieving better throughputs. The display functions range from small-sized segment LDC drive to QVGA color display. A wide array of sensor interfaces recently attracting attention are also available. In addition to digital SIO such as SPI, UART, and I²C and the low power ADCs, the Epson original frequency conversion type ADC is capable of supporting measurements by resistance thermometer sensors and humidity sensors. A variety of these functions, low power technology and a highly efficient processor are all built into a single chip. With this one-chip solution, Epson continues to offer optimum products for small-sized battery-driven equipment, operation panel controllers, and sensor built-in healthcare products and housing equipment.

CPU Core Lineup

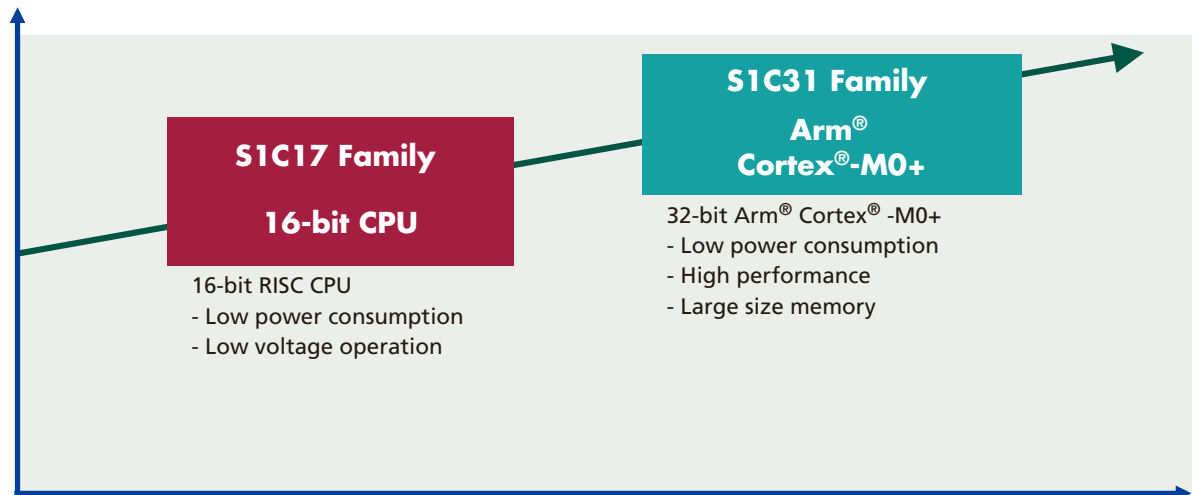

Application Example

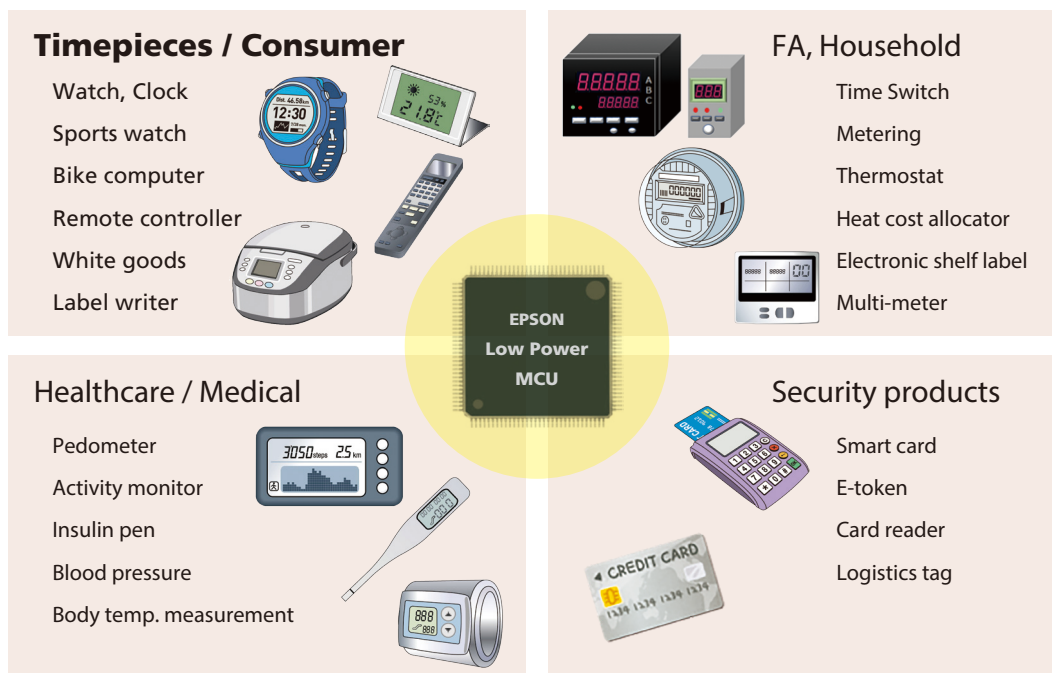

Lowest Current Consumption (16-bit microcontrollers)

In most cases, the S1C17 Family of products will allow customers currently using 8-bit microcontrollers to enjoy higher performance with the same power consumption. In addition, it will enable customers already using 16-bit/32-bit microcontrollers to benefit from longer battery life as a result of low operating voltage.

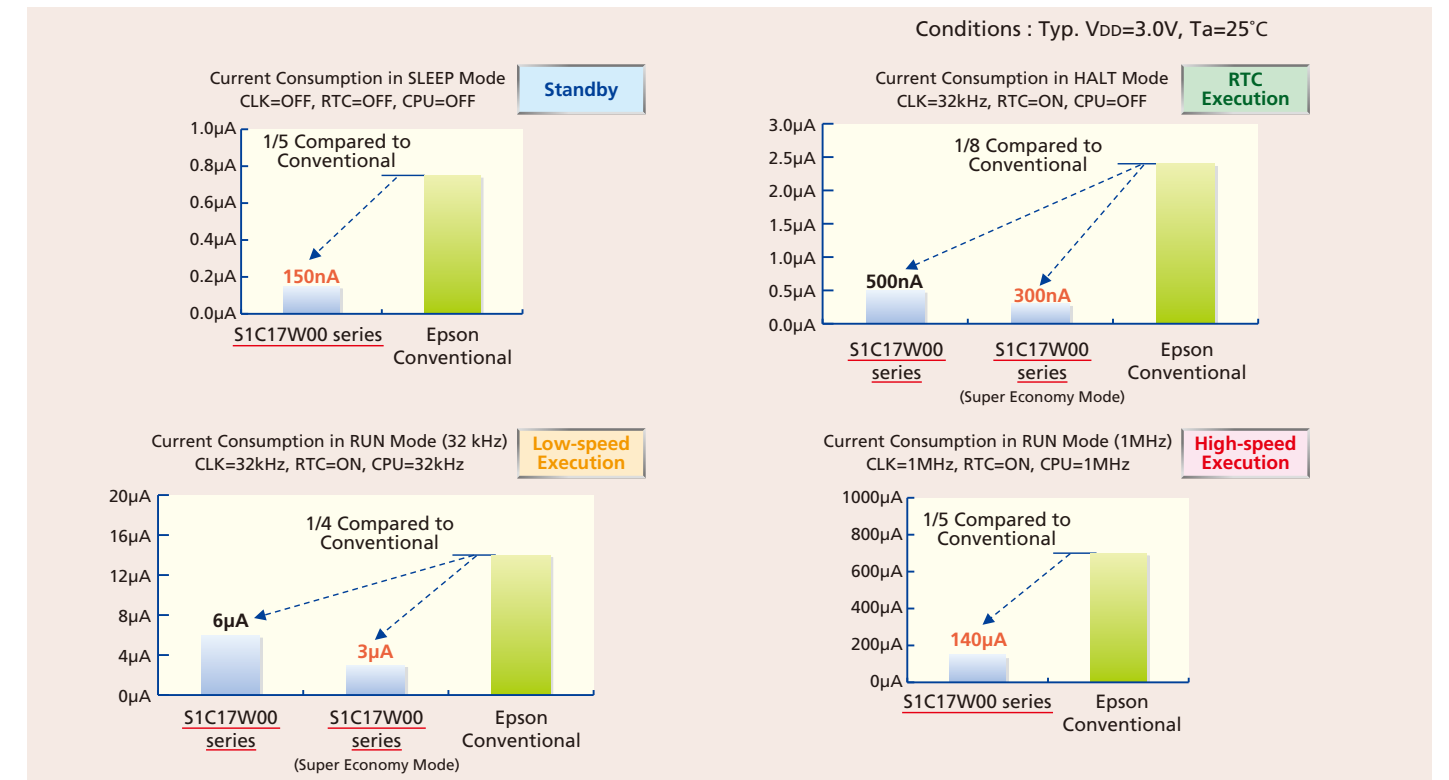

Four types of clock sources

Four types of characteristic clock sources can be freely selected for each circuit.

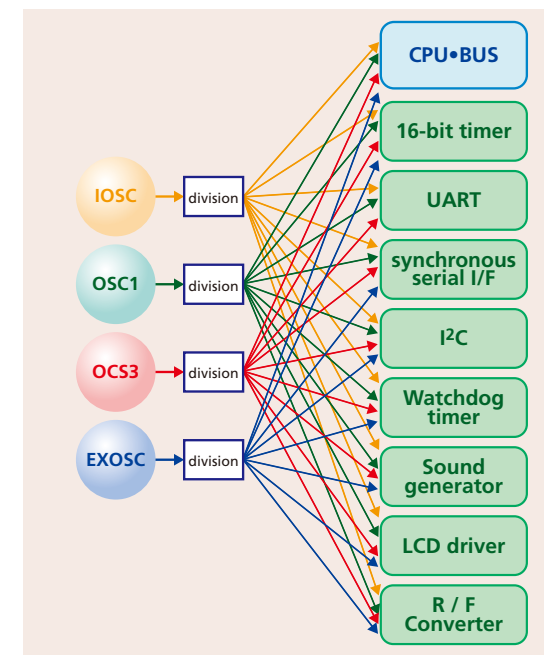

Terminals can be allocated freely (Universal Port Multiplexers)

SPI, I²C, UART, 16-bit PWM, and other terminals can be freely allocated as individual UPMUX terminals using software.

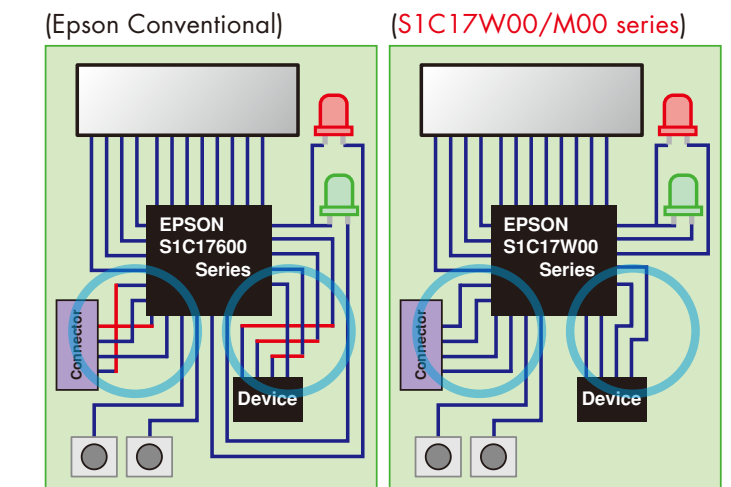

MCUs Features of Epson microcontrollers

Supporting various types of LCD

Black & White LCD driver

- Segment LCD driver
 - 12 to 88seg x 4/8com
 - 1/3 bias LCD voltage booster built-in
- Dot Matrix LCD driver
 - 56 to 128seg x 16/24/32/64com
 - 1/4,1/5 bias LCD voltage booster built-in

Models containing Black & White LCD driver :

- S1C17W10 group
- S1C17W20 group
- S1C17W30 group
- S1C17M30 group
- S1C17M40 group
- S1C31W00 series

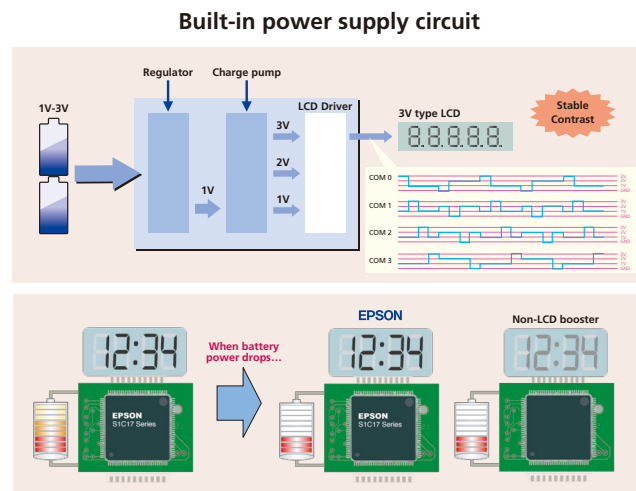

Segment LCD

Dot matrix LCD

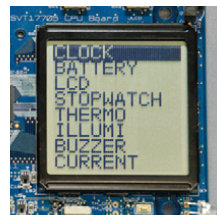
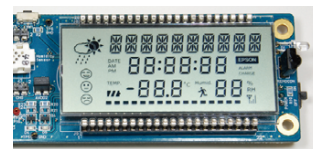

Memory display

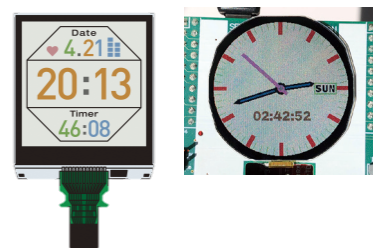

LCD controller

- STN/TFT LCD controller
 - 320 x 240monochrome / 320 x 240 (QVGA)16gradations
- Memory display controller
 - 300 x 300 6-bit color / 640 x 640 Black & White
 - Supporting graphic engine function

Models containing LCD controller :

- S1C17800 series
- S1C31D00 series

Segment EPD driver

- 42 to 256seg + TP/BP
- Voltage booster built-in

Models containing EPD driver :

- S1C17F00 series

Segment LED driver

- 8seg x 5com supporting 5V

Models containing LED driver :

- S1C17M12/M13

Segment EPD



Segment LED



MCUs Features of Epson microcontrollers

A large number of different types of interfaces are included

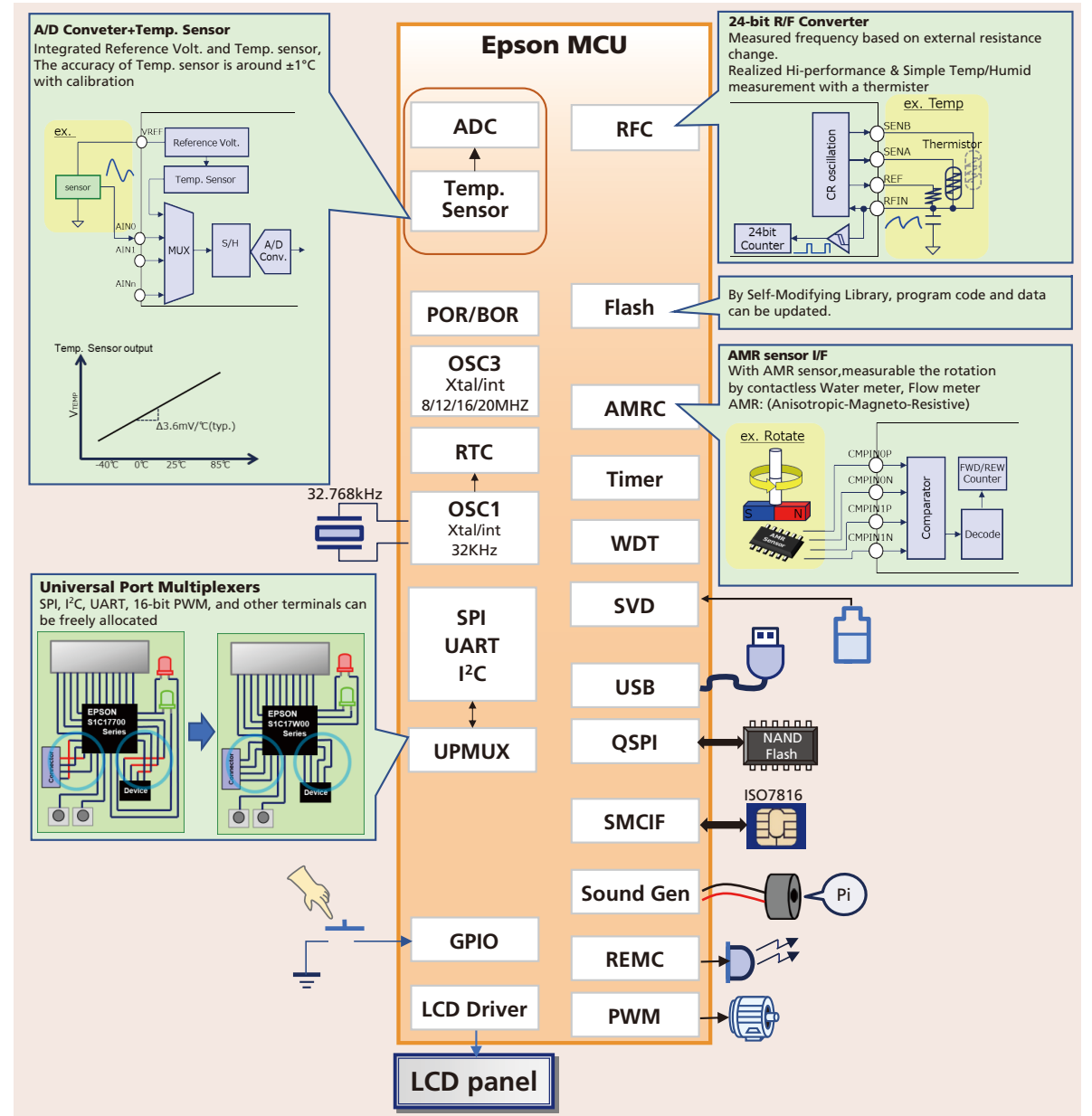

Product Dedicated Unique Peripherals

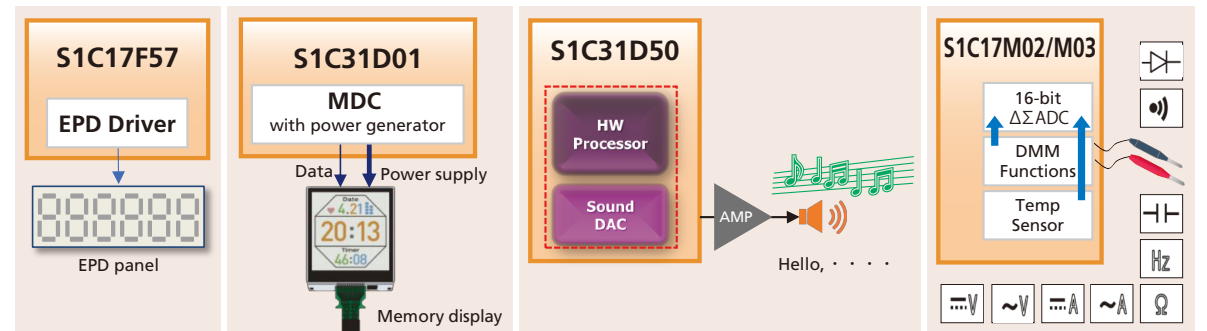

*: Peripheral circuits configured by products are different.

Suitable for wearable and industrial control devices Guaranteed 105°C operation Arm® microcontroller with LCD driver S1C31W00 Series *1

*1 : S1C31W74 is -40°C to 85°C operation guarantee

General

The S1C31W00 series is 32-bit MCU with an Arm® Cortex®-M0+ processor included that features low-power operation. It has a guaranteed operating temperature up to 105°C, suitable for industrial applications. In addition, it integrates LCD driver (MAX.2,560-dot) and a lot of serial interface circuits.

Large capacity memory

Large capacity memory corresponding to market trend of multi functionality is integrated on a single chip. It is possible to store and operate user programs that size is increasing by complicated software design.

Suitable for diverse product environments

Considering the operating environment of industrial equipment, it guarantees operation from -40°C to 105°C without frequency or supply voltage limitations.

Built-in high resolution LCD driver

S1C31W series can drive dot-matrix or 7-segment LCD by built-in LCD driver. It equips internal constant voltage circuit that has been cultivated over the Epson traditional products, and can maintain display quality that is not affected by the remaining battery level. The contrast can be adjusted by software. It offers optimum and flexible design for user's product development.

Wide variety of interface

In addition to UART, SPI and I2C, it supports Quad-SPI (QSPI) which can communicate with external serial flash memory at high speed. An R/F converter for temperature and humidity measurement, USB FS 2.0 device controller, Universal port multiplexers that increase board layout design flexibility are also supported.

* It depends on the product which interface are supported.

S1C31W00 Series Products overview

Products	Display LCD Driver segxcom	Operation clock			Supply current			Power supply			Memory			I/O port	Timer				SIO				Analog			Reset		Others		Form of delivery			
		High-speed [Hz] (Max.)	Low-speed [Hz] (Typ.)	Built-in oscillator [Hz] (Typ.)	Sleep [μA] (Typ.)	Halt [μA] (Typ.)	mode0 Operating [μA/MHz] (Typ.)	mode1 Operating [μA/MHz] (Typ.)	Normal Operation [V]	Flash Programming [V]	Flash ROM [Byte]	Display RAM [Byte]	RAM [Byte]		16-bit timer	16-bit PWM timer	Watchdog timer	Real-time clock	UART	SPI	Quad SPI	I ² C	Remote controller transmission and reception	R/F converter (24-bit)	A/D converter (12-bit)	SVD	POR	BOR	Sound generator	USB	Special function	Package	Chip
S1C31W65	52 x 8 56 x 4	33M	32.768k	32k/1M/2M/ 8M/12M/16M/ 24M/32M	0.3	1.5	195	130	1.8 to 5.5	2.2 to 5.5	128K	112	16K	64	8	3 x 4	1	1	2	2	-	2	1	1	7	1	○	○	1	-	DMA	TQFP15-100	-
S1C31W73	96 x 16 88 x 24 80 x 32	33M	32.768k	32k/1M/2M/ 8M/12M/16M/ 24M/32M	0.7	2.0	214	150	1.8 to 5.5	2.2 to 5.5	384K	768	32K	73	8	2 x 4	1	1	2	2	1	2	1	1	7	1	○	○	1	1	DMA	QFP21-216	○
S1C31W74	88 x 16 80 x 24 72 x 32	21M	32.768k	1M/2M/8M/ 12M/16M/20M	0.4	1.7	250	150	1.8 to 3.6	2.4 to 3.6	512K	704	128K	71	4	2 x 2	1	1	2	1	1	2	1	1	-	2	○	○	1	1	-	VF8GA8H-181	○

S1C31D01/S1C31D00 Products overview

Products	Display controller	Operation clock			Supply current			Power supply			Memory			I/O port	Timer				SIO				Analog			Reset		Others		Form of delivery		
		High-speed [Hz] (Max.)	Low-speed [Hz] (Typ.)	Built-in oscillator [Hz] (Typ.)	Sleep [μA] (Typ.)	Halt [μA] (Typ.)	mode0 Operating [μA/MHz] (Typ.)	mode1 Operating [μA/MHz] (Typ.)	Normal Operation [V]	Flash Programming [V]	Flash ROM [Byte]	RAM [Byte]	16-bit timer		16-bit PWM timer	Watchdog timer	Real-time clock	UART	SPI	Quad SPI	I ² C	Remote controller transmission and reception	R/F converter (24-bit)	A/D converter (12-bit)	SVD	POR	BOR	Sound generator	USB	Special function	Package	Chip
S1C31D01	MDC	21M	32.768k	32k/1M/2M/ 8M/12M/16M/20M	0.46	1.7	250	155	1.8 to 5.5	2.4 to 5.5	256K	96K	57	8	2 x 6	1	1	3	2	1	2	1	-	7	1	○	○	1	1	DMA	WCSP96 QFP14-80 VF8GA5H-81	○

S1D13C00 Products overview

Products	CPU Interface Support	Panel Interface Support	Color Depth (Max.)	Internal Memory Capacity	Supply Voltage	Additional Features	Package
S1D13C00F00C B00C	SPI, QSPI, Indirect 8-bit	6-bit color MIP, 3-bit or 1-bit Memory LCD with SPI	64 colors	96KB	1.8V to 5.5V	RTC, SPI, QSPI, I2C, DMAC, Sound Generator IR remote control transmitter	TQFP13-64 WCSP64

Suitable for battery-driven wearable products Arm® microcontroller with a memory display controller "S1C31D01"

General

The S1C31D01 is a 32-bit MCU with an Arm® Cortex®-M0+ processor included that features low-power operation. It integrates a lot of serial interface circuit, a memory display controller, and a voltage booster.

Memory Display Controller (MDC)

MDC supports several panel interfaces for each memory display. It includes graphics hardware acceleration functions such as rotation of frame buffer image to panel, Image/bitmap copy with scaling/rotation/horizontal and vertical shearing/alpha-blending*, Line/Rectangle/Ellipse/Arc drawing with filled and unfilled. It can contribute to reduce software load by dedicated hardware.

Power booster circuit

The S1C31D01 generates supply voltages for memory display (VMDH/VMDL) with programmable power booster circuit. It is possible to reduce external components.

Small size package

Wafer level Chip Size Package (WCSP) is supported as same size with chip. It is suitable for various applications which have limited mounting area on the print circuit board.

Lineup

Epson prepares CPU-less dedicated memory display controller "S1D13C00" for the customers who already have Host CPU. It supports same features with S1C31D01 about graphic acceleration function and power booster circuit. There is a variety of products that can be selected according to your system.

Examples of Graphic Acceleration

Drawing Engine



Image / Bitmap copy

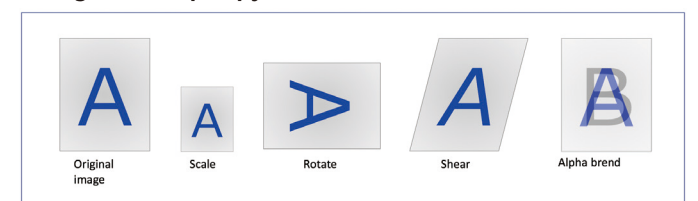

Application Example: Sport watch

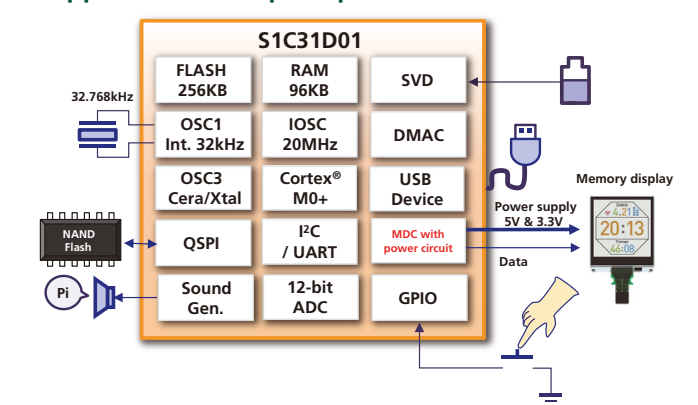

* Alpha-blending: supported at 6-bit color only.

ideal sound solution for home appliances and electronics Arm® microcontroller with Dedicated Sound Hardware "S1C31D50/51/41"

General

The S1C31D50/51/41 is a 32-bit Arm® Cortex®-M0+ MCU which integrates a specific hardware block called the HW Processor.

HW Processor

The HW Processor can perform 2ch Voice/Audio Play, Voice Speed Conversion, and Self Memory Check without using any CPU resources.

2ch mixing play

A dedicated HW Processor provides 2-channel sound on a single MCU chip. The use of two channels enables music and voice to be played simultaneously. The audio guidance becomes more elegant and warmer.

Voice Speed Conversion

The speed of the easy-to-hear voice depends on the end user. This function enables to adjust the speed by the end user.

Buzzer Voice play(D51/D41)

By making it possible to output voice guidance sound like error and

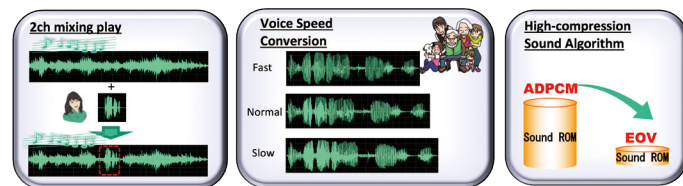

warning messages on a buzzer instead of a speaker, the usability of the MCU is increased. Common buzzer sound output performance is often very poor because of low volume and limited bandwidth. Epson improved buzzer performance by using new development algorithm.

Pitch conversion(D41)

The pitch of the comfortable-to-hear voice depends on the end user. This function enables to adjust the speed by the end user.

High-compression Sound Algorithm

Epson high-compression algorithm(EOV) cultivated in Epson LSI business is inherited. For example, the data size of 1min voice at 15.625kHz sampling frequency is about 120KB. It is 1/4 size of the data created by ADPCM.

Self-Memory Check

HW processor can detect failures in built-in RAM, built-in Flash, and external SPI-Flash memories without using CPU resources.

Block Diagram

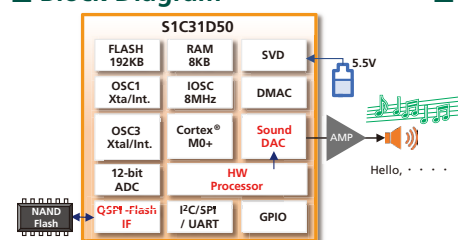

Applications

Boiler Remote Controller
Fire/Smoke Alarm

Main Features

	S1C31D50	S1C31D51	S1C31D41
Flash	192KB	10KB	96KB
RAM	8KB	10KB	8KB
HW Processor	2ch mixing play(ch0 and ch1) Voice Speed Conversion(only ch0) Voice Pitch Conversion(D41) Self Memory Check(On Chip RAM, On Chip Flash, External SPI-Flash)	+12KB HW Processor not active	+18KB HW Processor not active
Sound DAC	Sampling Frequency: 15.625kHz		
Serial Interface	SPI(3ch), UART(3ch), I2C(3ch), QSPI(1ch)		
Sound Play Method	AMP + Speaker	AMP + Speaker Simple circuit + Speaker Simple circuit + Buzzer	
ADC	12-bit (Max. 8-port)		12-bit (Max. 8-port, 1-port for temperature sensor)
SVD	V _{DD} : 28 levels (1.8V to 5.0V)/External voltage: 32 levels (1.2V to 5.0V)		
DMA	4ch (Memory ↔ Memory, Memory ↔ Peripheral)		
RFC	CR oscillation type 24-bit counters		
Timers	16-bit Timer (8ch), 16-bit PWM (2ch), WDT, RTC		
Power Supply	1.8V to 5.5V V _{DD} 3.3V SPI-Flash Interface Power Supply		
Flash Programming	2.4V to 5.5V		2.2V to 5.5V
Clock Frequency	Max. 16MHz (internal power: 1.8V) Max. 1.8MHz (internal power: 1.2V)		
Power Consumption	Standard Mode RUN: 250µA/MHz (internal power: 1.8V) Low Power Mode RUN: 155µA/MHz (internal power: 1.2V) Max. 1.8MHz SLEEP: 0.46µA, RTC mode: 0.95µA		Standard Mode RUN: 215µA/MHz (internal power: 1.8V) Low Power Mode RUN: 130µA/MHz (internal power: 1.2V) Max. 1.8MHz SLEEP: 0.34µA, RTC mode: 0.9µA
Package	P-TQFP048-0707-0.50 P-LQFP064-1010-0.50 P-LQFP080-1212-0.50 P-LQFP100-1414-0.50		P-TQFP032-0707-0.80 P-TQFP048-0707-0.50 P-LQFP064-1010-0.50
IEC-60730		supported by Sample SW	

Sound HW MCUs

Products	Display controller	Operation clock			Supply current			Power supply		Memory		I/O port	Timer				SIO				Analog			Reset		Others		Form of delivery				
		High-speed [Hz] (Max.)	Low-speed [Hz] (Typ.)	Built-in oscillator [Hz] (Typ.)	Sleep [µA] (Typ.)	Halt [µA] (Typ.)	mode0 Operating [µA/MHz] (Typ.)	mode1 Operating [µA/MHz] (Typ.)	Normal Operation [V]	Flash Programming [V]	Flash ROM [Byte]		RAM [Byte]	16-bit timer	16-bit PWM timer	Watchdog timer	Real-time clock	UART	SPI	Quad SPI	I2C	Remote controller transmission and reception	R/F converter (24-bit)	A/D converter (12-bit)	SVD	POR	BOR	Sound generator	USB	Special function	Package	Chip
S1C31D50 / 51	-	16M	32.768k	32k/4M/8M/16M	0.46	1.8	250	155	1.8 to 5.5	2.4 to 5.5	192K	8K	39 55 71 91	8	2 x 4	1	1	3	3	1	3	1	1	5 7 8 8	1	○	○	-	-	DMA Sound HW	TQFP12-48 QFP13-64 QFP14-80 QFP15-100	-
S1C31D41	-	16M	32.768k	32k/4M/8M/16M	0.34	1.5	215	130	1.8 to 5.5	2.2 to 5.5	96K	8K	25 39 55	8	2 x 4	1	1	3	3	1	3	1	1	6 7 8	1	○	○	-	-	DMA Sound HW	TQFP12-32 TQFP12-48 TQFP13-64	-

User-Friendly Substantial Development Environment Voice Creation PC Tool, Simple sound play interface, easy sound data update in market

S1C31D50/51/41 Development Environment provides User-Friendly Substantial Development, this makes it easy to create natural voice data and play the sound.

Epson Voice Creation PC Tool

Using Epson Voice Creation PC Tool, natural voice data can be created by just PC, so no need to struggle studio recording, announce arrangement and additional cost. Typically only text input to the tool is enough to create the voice data. The tool also supports phrase combination, pronunciation adjust and importing existing WAV file a customer already has.

[Supported Languages]

Asia : Japanese, Chinese (Mandarin), Korean
America : American English, American Spanish, Canadian French
Europe : British English, German, French, Spanish, Italian, Russian

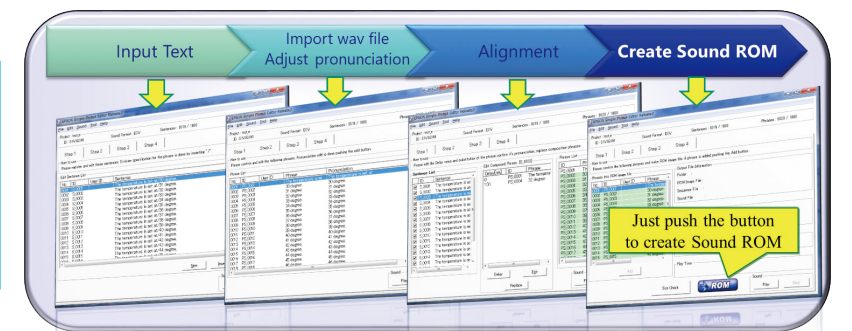

Link between Voice creation Tool and IC

Epson Voice Creation PC tool also makes it easy to develop firmware. A firmware engineer does not need to care phrase combination and delay among phrases etc, because all information is included in Sound ROM and Hardware Processor. By just setting the Sentence Number on the tool to IC register, the sound can be played.

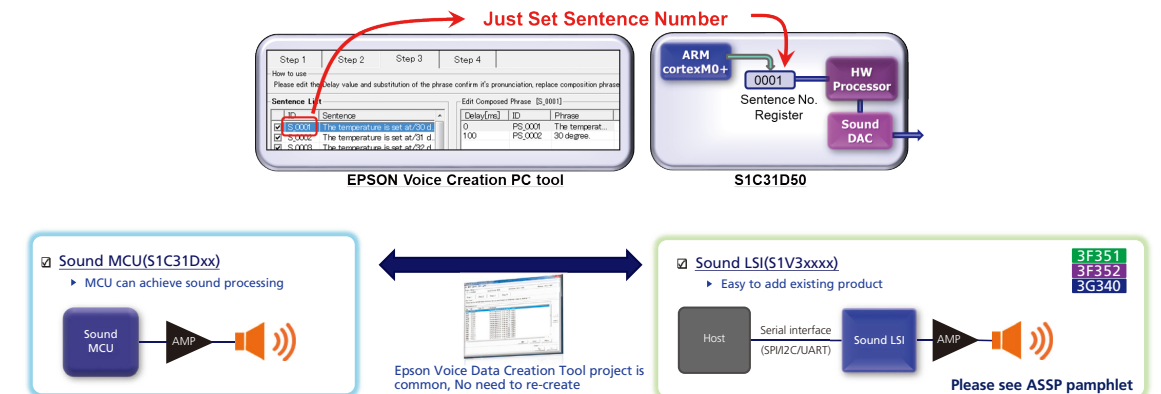

Evaluation Board

4 languages sound demo with melody is preset. Pushing the button on the evaluation board, 2ch mixing sound can be played. Also customers can write new sound ROM Data from PC to this board and play own sound easily.

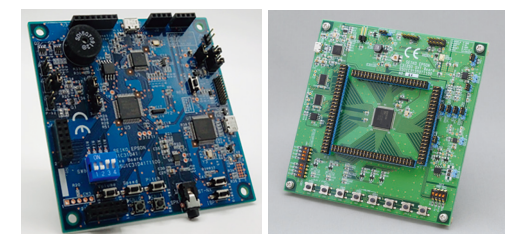

S1C31D41

S1C31D50

World realized by low power consumption of the S1C17W00 Series

Case of Digital Watch

Conditions: Continuous LCD watch display using LR44 battery (1.5 V)

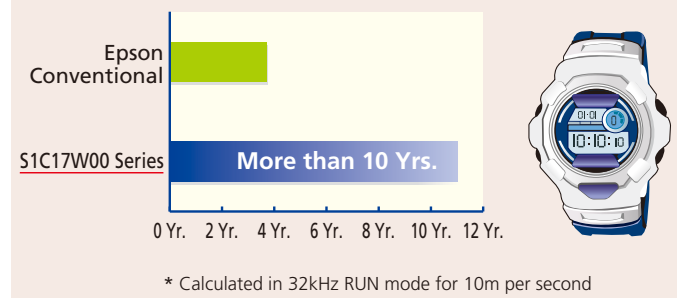

Case of Pedometer

Conditions: LCD display and acceleration sensing for several hours per day using the CR2032 battery (3V)

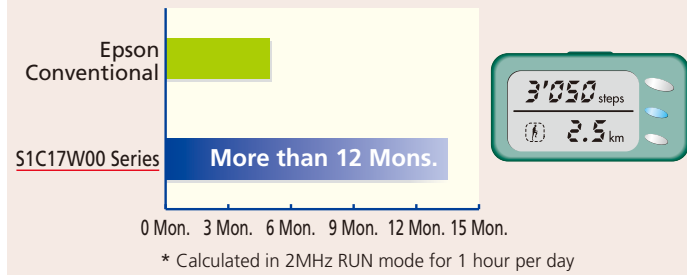

S1C17W00 Series Products overview

Products	Display	Operation clock			Supply current				Power supply	Memory		I/O port	Timer				SIO				Analog				Others		Form of delivery		
		LCD Driver segxcom	High-speed [Hz] (Max.)	Low-speed [Hz] (Typ.)	Built-in oscillator [Hz] (Typ.)	Sleep [μA] (Typ.)	Halt [μA] (Typ.)	32kHz Operating [μA] (Typ.)		1MHz Operating [μA] (Typ.)	Flash ROM [Byte]		RAM [Byte]	16-bit timer	16-bit PWM timer	Watchdog timer	Real-time clock	UART	SPI	QSPI	I ² C	Remote controller transmission and reception	R/F converter (24-bit)	A/D converter (12-bit)	SVD *4	Sound generator	Multiple r/Divider	Special function	Package
<p>S1C17W00 series W00 group</p> <p>[Ultra Low Power] This is an ultra-low power consumption 16-bit MCU compatible to low voltage operations from 1.2V, even with built-in flash memory. The embedded highly efficient DC-DC converter generates an internal constant voltage, to drive an IC with a low power consumption operation beyond 4-bit MCUs. This product is equipped with a built-in RTC, stopwatch, high-performance PWM, external bus I/F and improved analog functions, combined with the powerful processing capacity of the 16-bit CPU, suitable for battery driven applications.</p>																													
S1C17W03	-	4.2M	32.768k	250k/384k/500k/700k/1M/2M/4M	0.15	0.3	4	250	1.2 to 3.6	16K	2K	35	4	2 x 2	1	1	2	2	-	1	1	2 ^{*5}	6	1	1	1	-	TQFP12-48	○
S1C17W04	-	4.2M	32.768k	250k/384k/500k/700k/1M/2M/4M	0.15	0.3	4	250	1.2 to 3.6	32K	2K	35	4	2 x 2	1	1	2	2	-	1	1	2 ^{*5}	6	1	1	1	-	TQFP12-48	○
<p>S1C17W00 series W10/W20/W30 group</p> <p>[Ultra Low Power] This is an ultra-low power consumption 16-bit MCU compatible to low voltage operations from 1.2V, even with built-in flash memory. The embedded highly efficient DC-DC converter generates an internal constant voltage, to drive an IC with a low power consumption operation beyond 4-bit MCUs. This product is equipped with a built-in RTC, LCD driver, high-performance PWM and improved analog functions, combined with the powerful processing capacity of the 16-bit CPU, suitable for battery driven applications that require a LCD and clock function.</p>																													
S1C17W12	26 x 4 18 x 4	4.2M	32.768k	32k/250k/384k/500k/700k/1M/2M/4M	0.15	0.3	2	140	1.2 to 3.6	48K	2K	32	3	2 x 2	1	1	2	1	-	1	1	2 ^{*5}	-	1	1	1	LED pin x 2	-	○
S1C17W13	26 x 4 18 x 4 20 x 4	4.2M	32.768k	32k/250k/384k/500k/700k/1M/2M/4M	0.15	0.3	2	140	1.2 to 3.6	48K	2K	32	3	2 x 2	1	1	2	1	-	1	1	2 ^{*5}	-	1	1	1	LED pin x 2	○	
S1C17W14	54 x 4 50 x 8	4.2M	32.768k	250k/384k/500k/700k/1M/2M/4M	0.15	0.3	3	200	1.2 to 3.6	48K	4K	33	3	2 x 2	1	1	2	2	-	1	1	1	-	1	1	1	-	QFP15-100	○
S1C17W15	34 x 4 30 x 8 32 x 4 28 x 8 24 x 4 20 x 8	4.2M	32.768k	500k/700k/1M/2M/4M	0.15	0.3	4	250	1.2 to 3.6	64K	4K	33	3	2 x 2	1	1	2	1	-	1	-	4 ^{*5}	-	1	1	1	-	QFP15-100	○
S1C17W16	60 x 4 56 x 8	4.2M	32.768k	250k/384k/500k/700k/1M/2M/4M	0.15	0.3	3	200	1.2 to 3.6	64K	8K	40	5	2 x 2	1	1	2	3	-	1	1	2 ^{*5}	4	1	1	1	-	TQFP15-128	○
S1C17W18	48 x 4 44 x 8 32 x 4 28 x 8 24 x 4 20 x 8	4.2M	32.768k	250k/384k/500k/700k/1M/2M/4M	0.15	0.3	2	140	1.2 to 3.6	128K	8K	68	4	3 x 2	1	1	2	2	-	1	1	2 ^{*5}	7	1	1	1	Temperature sensor	TQFP15-128	○
S1C17W22	72 x 4/8 64 x 16 56 x 24	4.2M	32.768k	500k/700k/1M/2M/4M	0.15	0.3	4	250	1.2 to 3.6	64K	4K	42	2	2 x 2	1	1	1	1	-	1	1	2 ^{*5}	-	1	1	1	-	TQFP15-128	○
S1C17W23	72 x 4/8 64 x 16 56 x 24	4.2M	32.768k	500k/700k/1M/2M/4M	0.15	0.3	4	250	1.2 to 3.6	96K	8K	42	4	3 x 2	1	1	2	2	-	1	1	2 ^{*5}	6	1	1	1	-	TQFP15-128	○
S1C17W34	80 x 16 64 x 32	4.2M	32.768k	250k/384k/500k/700k/1M/2M/4M	0.15	0.4	3	150	1.2 to 3.6	128K	12K	53	4	3 x 2	1	3	2	2	-	1	1	2 ^{*5}	7	1	1	1	Temperature sensor	QFP21-176	○
S1C17W35	80 x 16 64 x 32	4.2M	32.768k	250k/384k/500k/700k/1M/2M/4M	0.15	0.4	3	150	1.2 to 3.6	256K	12K	53	4	3 x 2	1	3	2	2	-	1	1	2 ^{*5}	7	1	1	1	Temperature sensor	QFP21-176	○
S1C17W36	80 x 16 64 x 32	4.2M	32.768k	250k/384k/500k/700k/1M/2M/4M	0.15	0.4	3	150	1.2 to 3.6	384K	16K	53	4	3 x 2	1	3	2	2	-	1	1	2 ^{*5}	7	1	1	1	Temperature sensor	QFP21-176	○

*1: During erasing / programming in flash memory (V_{DD}): 1.8V to 3.6V

*2: During operations LCD (V_{DD}): 2.5V to 3.6V

*3: During erasing / programming voltage in flash memory (V_{PP}): The external applying of 7.5V / 7.5V (Typ.) is needed. (*3) can be rewritten even with internal power supply.

*4: SVD is an abbreviation for Supply Voltage Detector.

*5: Independent operation for each channel.

*6: During erasing / programming in flash memory (V_{DD}): 2.4V to 3.6V

S1C17W00 Series Application examples

Example of an application using the S1C17W13: Remote controller

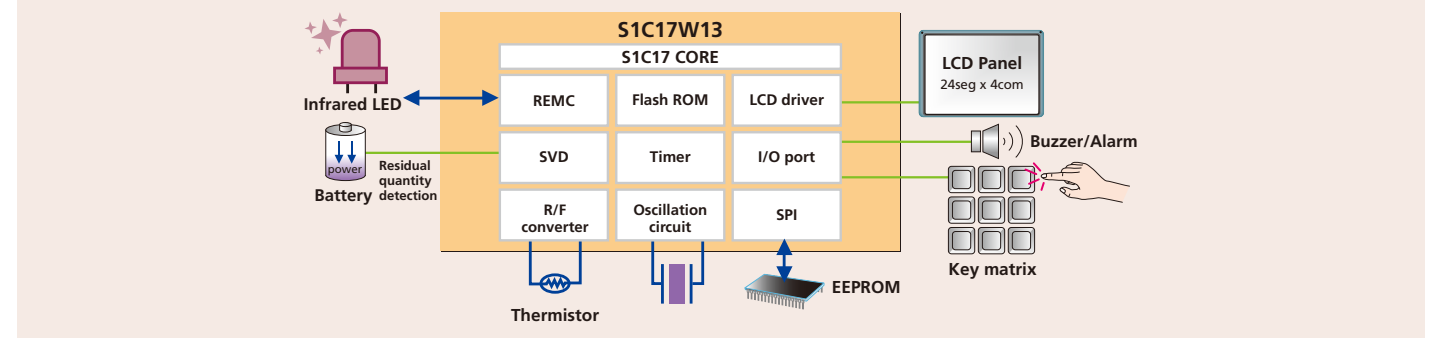

*7: External voltage application mode only.

*8: Including Input port and Output port.

■ S1C17M00 Series Application examples

Example of an application using the S1C17M02/03: Digital Multimeter

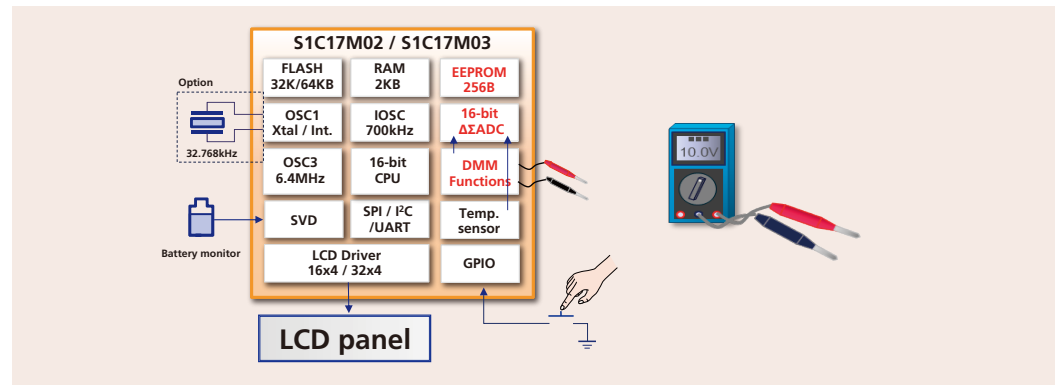

■ S1C17M00 Series Products overview

Products	Display		Operation clock			Supply current				Power supply	Memory			I/O port ⁵	Timer				SIO					Analog		Reset		Others			Form of delivery		
	LCD Driver segxcom	Display controller	High-speed [Hz] (Max.)	Low-speed [Hz] (Typ.)	Built-in oscillator [Hz] (Typ.)	Sleep [μA] (Typ.)	Halt [μA] (Typ.)	32kHz Operating [μA] (Typ.)	1MHz Operating [μA] (Typ.)		Supply voltage [V]	Flash ROM [Byte]	EEPROM [Byte]		RAM [Byte]	16-bit timer	16-bit PWM timer	Watchdog timer	Real-time clock	UART	SPI	Quad SPI	I ² C	Remote controller transmission and reception	RF converter (24-bit)	AD converter (12-bit)	SVD ⁴	POR	BOR	Sound generator	Multiple r/Divider	Special function	Package
S1C17M00 series																																	
It is an application specialized series. It is a 16-bit MCU with Flash memory compatible with high processing while achieving low power consumption, supporting power supply voltages from 1.8 V to 5.5 V. (S1C17M02/M03 are excluded)																																	
S1C17M01	32 x 4 28 x 8	-	16.3M	32.768k	7.37M	0.35	0.8	12.5	210	1.8 to 5.5 ^{*7}	32K ^{*3}	-	4K	19	5	-	1	1	1	2	-	1	-	1	○	-	-	-	AMRC	TQFP13-64	○		
S1C17M02	16 x 4	-	6.4M	32.768k	32k/700k/ 3.2M/6.4M	0.24	0.9	5	-	2.1 to 3.6 ^{*2}	32K ^{(*)3}	256	2K	19	4	-	1	-	1	1	-	1	-	1	○	○	1	1	Measurement function for DMM (Sigma delta type AD converter)	QFP13-64	-		
S1C17M03	32 x 4	-	6.4M	32.768k	32k/700k/ 3.2M/6.4M	0.24	0.9	5	-	2.1 to 3.6 ^{*2}	64K ^{(*)3}	256	2K	43	4	-	1	-	1	1	-	1	-	1	○	○	1	1	Measurement function for DMM (Sigma delta type AD converter)	QFP15-100	-		
S1C17M10	88 x 8 80 x 16	-	16M	32.768k	32k/ 4M/8M/ 12M/16M	0.16	0.6	4	145	1.8 to 5.5 ^{*9}	64K ^{(*)3}	-	4K	33	5	1 x 2	1	1	1	1	-	1	-	1	○	-	-	1	SMCIF	TQFP15-128	○		
S1C17M12	-	LED controller 8x5	16.8M	-	4M/8M/ 12M/16M	0.35	40	-	150	1.8 to 5.5 ^{*9}	16K ^{*3}	-	2K	39	4	1 x 2	1	-	1	2	-	1	-	1	○	○	-	1	High current port x 5	TQFP12-48	○		
S1C17M13	-	LED controller 8x5	16.8M	-	4M/8M/ 12M/16M	0.35	40	-	150	1.8 to 5.5 ^{*9}	16K ^{*3}	-	2K	39	4	1 x 2	1	-	1	2	-	1	-	8	1	○	○	-	1	High current port x 5	TQFP12-48	○	
S1C17M20	-	-	21M	-	32k/700k/ 12M/16M/20M	0.36	1.5 0.7	5.5 5	160	1.8 to 5.5 ^{*9}	16K ^{(*)3}	-	2K	18 24	4	2 x 2	1	1	2	2	-	1	-	4 6	1	○	○	1	1	-	SQFN4-24 SQFN5-32	-	
S1C17M21	-	-	21M	32.768k	32k/700k/ 12M/16M/20M	0.36	0.7	5	160	1.8 to 5.5 ^{*9}	16K ^{(*)3}	-	2K	24	4	2 x 2	1	1	2	2	-	1	-	6	1	○	○	1	1	-	TQFP12-32	-	
S1C17M22	-	-	21M	32.768k	32k/700k/ 12M/16M/20M	0.36	0.7	5	160	1.8 to 5.5 ^{*9}	16K ^{(*)3}	-	2K	40	4	2 x 2	1	1	2	2	-	1	1	2	8	1	○	○	1	1	-	TQFP12-48	-
S1C17M23	-	-	21M	-	32k/700k/ 12M/16M/20M	0.36	1.5 0.7	5.5 5	160	1.8 to 5.5 ^{*9}	32K ^{(*)3}	-	2K	18 24	4	2 x 2	1	1	2	2	-	1	-	4 6	1	○	○	1	1	-	SQFN4-24 SQFN5-32	-	
S1C17M24	-	-	21M	32.768k	32k/700k/ 12M/16M/20M	0.36	0.7	5	160	1.8 to 5.5 ^{*9}	32K ^{(*)3}	-	2K	24	4	2 x 2	1	1	2	2	-	1	-	6	1	○	○	1	1	-	TQFP12-32	-	
S1C17M25	-	-	21M	32.768k	32k/700k/ 12M/16M/20M	0.36	0.7	5	160	1.8 to 5.5 ^{*9}	32K ^{(*)3}	-	2K	40	4	2 x 2	1	1	2	2	-	1	1	2	8	1	○	○	1	1	-	TQFP12-48	-
S1C17M30	26 x 4 22 x 8 *6	-	16.8M	32.768k	32k/700k/ 12M/16M	0.2	0.7	5	160	1.8 to 5.5 ^{*9}	48K ^{(*)3}	256 ^{*8}	4K	38	4	3 x 2	1	1	2	2	-	1	1	2	2	1	○	○	1	1	-	TQFP12-48	-
S1C17M31	26 x 4 22 x 8	-	16.8M	-	32k/700k/ 12M/16M	0.2	1.4	5.5	160	1.8 to 5.5 ^{*9}	48K ^{(*)3}	256 ^{*8}	4K	38	4	3 x 2	1	1	2	2	-	1	1	2	2	1	○	○	1	1	-	TQFP12-48	-
S1C17M32	42 x 4 38 x 8 *6	-	16.8M	32.768k	32k/700k/ 12M/16M	0.2	0.7	5	160	1.8 to 5.5 ^{*9}	64K ^{(*)3}	256 ^{*8}	4K	54	4	3 x 2	1	1	2	2	-	1	1	2	2	1	○	○	1	1	-	TQFP13-64	-
S1C17M33	50 x 4 46 x 8	-	16.8M	32.768k	32k/700k/ 12M/16M	0.2	0.7	5	160	1.8 to 5.5 ^{*9}	96K ^{(*)3}	32 to 512 ^{(*)3}	4K	66	4	3 x 2	1	1	2	2	-	1	1	2	5	1	○	○	1	1	-	QFP14-80	○
S1C17M34	37 x 4 33 x 8	-	16.8M	32.768k	32k/700k/ 12M/16M	0.2	0.7	5	160	1.8 to 5.5 ^{*9}	64K ^{(*)3}	256 ^{*8}	4K	52	4	3 x 2	1	1	2	2	-	1	1	2	5	1	○	○	1	1	-	TQFP13-64	-
S1C17M40	40 x 4 36 x 8	-	16.8M	32.768k	32k/700k/ 16M	0.25	0.7	5	-	1.8 to 5.5 ^{*1}	48K ^{(*)3}	256	2K	55	4	3 x 2	1	1	3	2	-	1	-	4	1	○	○	1	1	-	QFP13-64	-	
	28 x 4 24 x 8	-	16.8M	-	32k/700k/ 16M	0.25	1.4	5.5	-	1.8 to 5.5 ^{*1}	48K ^{(*)3}	256	2K	41	4	3 x 2	1	1	3	2	-	1	-	3	1	○	○	1	1	-	TQFP12-48	-	

*1: During erasing / programming in flash memory / EEPROM programming (V_{DD}): 2.2V to 5.5V
 *2: During erasing / programming in flash memory / EEPROM programming / Analog circuit operation (V_{DD}): 2.2V to 3.6V

3: During erasing / programming voltage in flash memory (V_{PP}): The external applying of 7.5V / 7.5V (Typ.) is needed. ()3 can be rewritten even with internal power supply.

*4: SVD is an abbreviation for Supply Voltage Detector.
 *5: Output dedicated port 1 included.
 *6: External voltage application mode only, to 5.5V

*7: (MR sensor controller) Operation (V_{DD}): 2.0V to 5.5V
 *8: AMRC Flash area is used.
 *9: During erasing / programming in flash memory (V_{DD}): 2.4V to 5.5V

■ S1C17M00 Series Function introduction

Example of 7 seg LED lighting up using the S1C17M12/M13

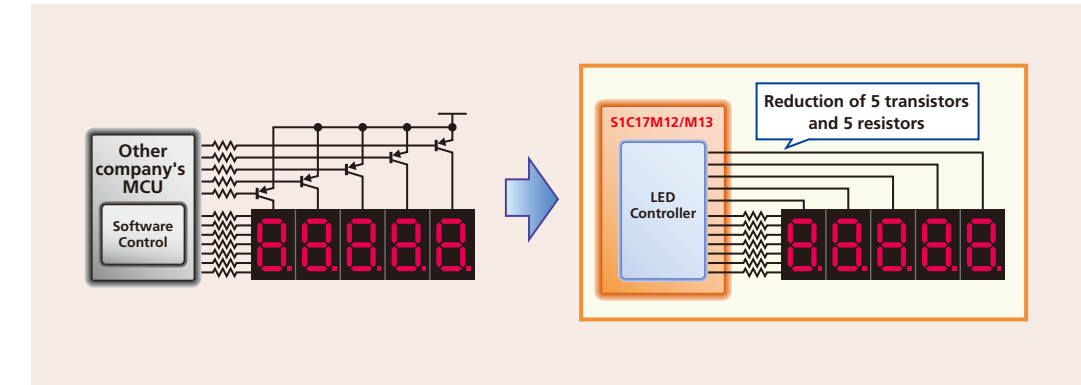

■ S1C17 Long-running Series

Products	Display	Operation clock			Supply current				Power supply	Memory			I/O port ⁹	Timer							SIO				Analog			Others			Form of delivery			
	LCD Driver segxcom	High-speed [Hz] (Max.)	Low-speed [Hz] (Typ.)	Built-in oscillator [Hz] (Typ.)	Sleep [μA] (Typ.)	Halt [μA] (Typ.)	32kHz Operating [μA] (Typ.)	1MHz Operating [μA] (Typ.)	Supply voltage [V]	Flash ROM [Byte]	Mask ROM [Byte]	RAM [Byte]		8-bit timer	16-bit timer	16-bit PWM timer	Stopwatch	Watchdog timer	Clock	Real-time clock	UART	SPI	I ² C master	I ² C slave	Remote controller transmission and reception	RF converter (24-bit)	A/D converter (10-bit)	SVD ⁵	Sound generator	Multiplier/Divider	Special function	Package	Chip	
S1C17100/600 series		[Low Power] This is a 16-bit MCU with improved processing capacity and development environment, while maintaining low power consumption equivalent to Epson's 4/8-bit MCUs. This product is equipped with a built-in segment LCD driver, power circuit, clock function and various I/F, suitable for watches, clocks, remote controllers and healthcare devices.																																
S1C17153	32 x 4	–	32.768k	500k/1M/2M	0.13	0.42	4	160	2.0 to 3.6	–	16K	2K	12	1	–	1	–	1	1	1	1	–	–	–	–	–	1	1	1	–	–	–	–	
S1C17651	20 x 4	4.2M	32.768k	32k/500k/1M/2M	0.09	0.42	10	350	2.0 to 3.6	16K ³	–	2K	12	1	–	1	–	1	1	1	1	–	–	–	–	–	1	1	1	–	–	–	TQFP13-64	○
S1C17653	32 x 4	4.2M	32.768k	32k/500k/1M/2M	0.09	0.42	10	350	2.0 to 3.6	16K ³	–	2K	12	1	–	1	–	1	1	1	1	–	–	–	–	–	1	1	1	–	–	–	QFP14-80	○ ⁷
S1C17656	32 x 4	–	32.768k	500k/1M/2M/4M	0.13	0.5	7.3	280	1.8 to 3.6	24K ⁴	–	2K	20	1	–	1	–	1	1	1	1	–	–	–	1	–	1	1	1	–	–	–	QFP14-80	○
S1C17601	20 x 4 16 x 8	8.2M	32.768k	2.7M	0.6	2.0	12	340	1.8 to 3.6 ¹¹	32K ⁶	–	2K	24	2	3	2	1	1	1	–	1	1	1	–	1	4	1	–	1	–	–	TQFP13-64	○	
S1C17621	40 x 4 36 x 8	8.2M	32.768k	2.7M	0.75	2.5	15	410	1.8 to 3.6 ¹¹	32K ⁶	–	2K	36	3	3	1	1	1	1	–	2	1	1	1	2	8	1	–	1	–	–	QFP14-100	○	
S1C17602	40 x 4 36 x 8	8.2M	32.768k	2.7M	0.75	2.5	15	410	1.8 to 3.6 ¹¹	64K ⁶	–	4K	36	3	3	1	1	1	1	–	2	1	1	1	2	8	1	–	1	–	–	QFP14-100	○	
S1C17622	56 x 4 52 x 8	8.2M	32.768k	2.7M	0.75	2.3	14	400	1.8 to 3.6 ¹¹	64K ⁶	–	4K	47	3	3	1	1	1	1	–	2	1	1	1	2	8	1	–	1	–	–	TQFP15-128	○	
S1C17604	40 x 4 36 x 8	8.2M	32.768k	2.7M	0.75	2.3	14	400	1.8 to 3.6 ¹¹	128K ⁶	–	8K	36	3	3	3	1	1	1	1	2	1	1	1	2	8	1	–	1	–	–	QFP14-100	○	
S1C17624	56 x 4 52 x 8	8.2M	32.768k	2.7M	0.75	2.3	14	400	1.8 to 3.6 ¹¹	128K ⁶	–	8K	47	3	3	3	1	1	1	1	2	1	1	1	2	8	1	–	1	–	–	TQFP15-128	○	
S1C17500 series		[Low Power] This is a 16-bit MCU with built-in flash memory, which realizes high-speed processing at low power consumption. This product is equipped with various features, such as a general-purpose I/O port, A/D converter input and serial I/F, and is suitable for controlling various sensor built-in devices, including household appliances.																																
S1C17589	–	16.8M	32.768k	4M/8M/12M/16M	0.2	0.6	9	280	1.8 to 5.5	128K ⁴	–	16K	88 68 52	–	6	4 x 6	–	1	–	1	3	2	1	1	1	–	16 11 7	1	1	–	–	–	QFP15-100 QFP14-80 QFP13-64	○ – –
S1C17700 series		It is an application specialized series. It is a 16-bit MCU with Flash memory compatible with high processing while achieving low power consumption, supporting power supply voltages from 1.8 V to 5.5 V.																																
S1C17711	64 x 16 56 x 24	8.2M	32.768k	2.7M	1.0	2.0	12	400	1.8 to 3.6 ¹¹	64K ⁶	–	4K	29	–	4	4	1	1	1	–	1	1	1	1	2	8	1	–	1	–	–	TQFP15-128	○	
S1C17702	88 x 16 72 x 32	8.2M	32.768k	2.7M	1.0	2.5	16	450	1.8 to 3.6 ¹¹	128K ⁶	–	12K	28	3	3	2	1	1	1	–	1	1	–	1	–	–	1	–	1	–	–	QFP21-176 VFPGA10H-180 VFPGA8H-181	○	
S1C17703	120 x 16/24/32 60 x 64	8.2M	32.768k	2.7M	1.0	2.5	15	450	1.8 to 3.6 ¹²	256K ⁶	–	12K	34	–	5	4	1	1	1	–	2	3	1	1	2	8	1	–	1	–	–	QFP21-216 VFPGA10H-240	○	
S1C17705	128 x 16/24/32 64 x 64	8.2M	32.768k	2.7M	1.2	2.7	18	550	1.8 to 3.6 ¹²	512K ⁶	–	12K	35	–	5	4	1	1	1	–	2	3	1	1	2	8	1	–	1	–	–	VFPGA10H-240	○	
S1C17800 series		[High Performance] This 16-bit MCU realized advanced processing equivalent to 32-bit. The built-in LCD controller provides maximum VGA monochrome displays. This product is equipped with abundant built-in I/F, such as USB, various serial interfaces and A/D converters, suitable for operation panel control of white home appliances and various products, with improved user interface utilizing displays, music, sound, touch panels and etc.																																
S1C17803	LCD Controllers	33M	32.768k	–	1.3 ¹⁰	5	–	6500	2.7 to 5.5	128K ⁶	–	16K	97 69	4	1	2	–	1	–	1 ¹¹	1	2 ¹²	1	1	1	–	4	–	1	–	BUS supported	TQFP15-128 QFP14-100	–	

*1: During erasing / programming in flash memory (V_{DD}): 2.7V to 3.6 V

*2: During erasing / programming in flash memory (V_{DD}): 2.5V to 3.6 V

*3: During erasing / programming voltage in flash memory (V_{PP}): The external applying of 7.5V / 7.0V (Typ.) is needed.

*4: During erasing / programming voltage in flash memory (V_{PP}): The external applying of 7.5V / 7.5V (Typ.) is needed.

*5: SVD is an abbreviation for Supply Voltage Detector.

*6: This product uses SuperFlash[®] technology licensed from SST UK Ltd.

*7: Al pad, Au bump

*8: Including Input port and Output port.

*9: Resolution: 12-bit

*10: Unmounted OSC1

*11: The battery backed up operation is supported.

*12: Universal serial interface (Any of UART, SPI and I²C functions can be selected.)

Products	Display	Operation clock			Supply current				Power supply	Memory			I/O port ⁹	Timer							SIO				Analog			Others			Form of delivery			
	EPD Driver seg (TP/BP)	High-speed [Hz] (Max.)	Low-speed [Hz] (Typ.)	Built-in oscillator [Hz] (Typ.)	Sleep [μA] (Typ.)	RTC [μA] (Typ.)	32kHz Operating [μA] (Typ.)	1MHz operating [μA] (Typ.)	Supply voltage [V]	Flash ROM [Byte]	EEPROM [Byte]	RAM [Byte]		8-bit timer	16-bit timer	16bit-PWM timer	Stopwatch	Watchdog timer	Clock	Real-time clock	UART	SPI	I ² C master	I ² C slave	Remote controller transmission and reception	RF converter (24-bit)	A/D converter	SVD ¹	Multiplier/Divider	Temperature detection circuit	Package	Chip		
S1C17F50 series		[Medium and small segment EPD] The product also includes embedded features such as a real-time clock, theoretical regulation, a driver capable of wringing the maximum performance from segmented EPDs, and a temperature sensor. As a result, the device does not simply drive the display, but also corrects temperature effects that could harm display quality making it possible to maximize the characteristics of an e-paper display with a single chip.																																
S1C17F57	64 (2TP/2BP)	4.2M	32.768k	32k/500k/1M/2M	0.10	0.21	12	410	2.0 to 3.6	32K ²	–	2K	29	2	–	2	1	1	1	1	1	1	1	–	1	–	1	1	1	–	–	–	–	
S1C17F63	42 (1TP/1BP)	16.8M	32.768k	500k/700k/1M/2M/4M/8M/16M	0.45	0.11	5	305	1.8 to 5.5 ⁵	32K ⁽²⁾	256	2K	17	–	4	2 x 2	–	1	–	1	1	2	1	–	–	7	1	1	1	–	–	–	QFP15-100	○ ³

*1: SVD is an abbreviation for Supply Voltage Detector.

*2: During erasing / programming voltage in flash memory (V_{PP}): The external applying of 7.0V / 7.5V (Typ.) is needed. (*2) can be rewritten even with internal power supply.

*3: Al pad, Au bump

*4: Including Input port and Output port.

*5: During erasing / programming in flash memory /EEPROM programming (V_{DD}): 2.2V to 5.5V

Overall development environment

Things prepared by customers



Debug Probe
Supported products
- IAR Systems I-Jet
- SEGGER J-LINK
etc.

Target board for product development

Offered from Epson

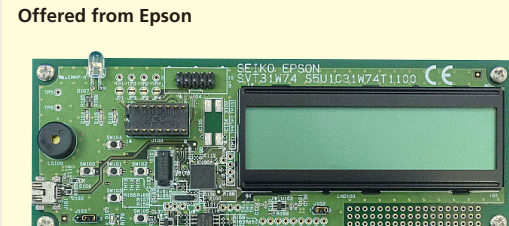

Initial evaluation target board

Integrated development environment
Supported products
- IAR Systems IAR Embedded Workbench for Arm
- Arm MDK-Arm
etc.

Offered from Epson



Model-specific information tool and Flash loader for integrated development environment

Sample program

Configuration tool for factory ROM write

Development support tool (Evaluation board)

- S1C31 chip built in
- Possible to evaluate the IC functions
- Provides a sample sources for various functions
- Debugging and Flash programming supported

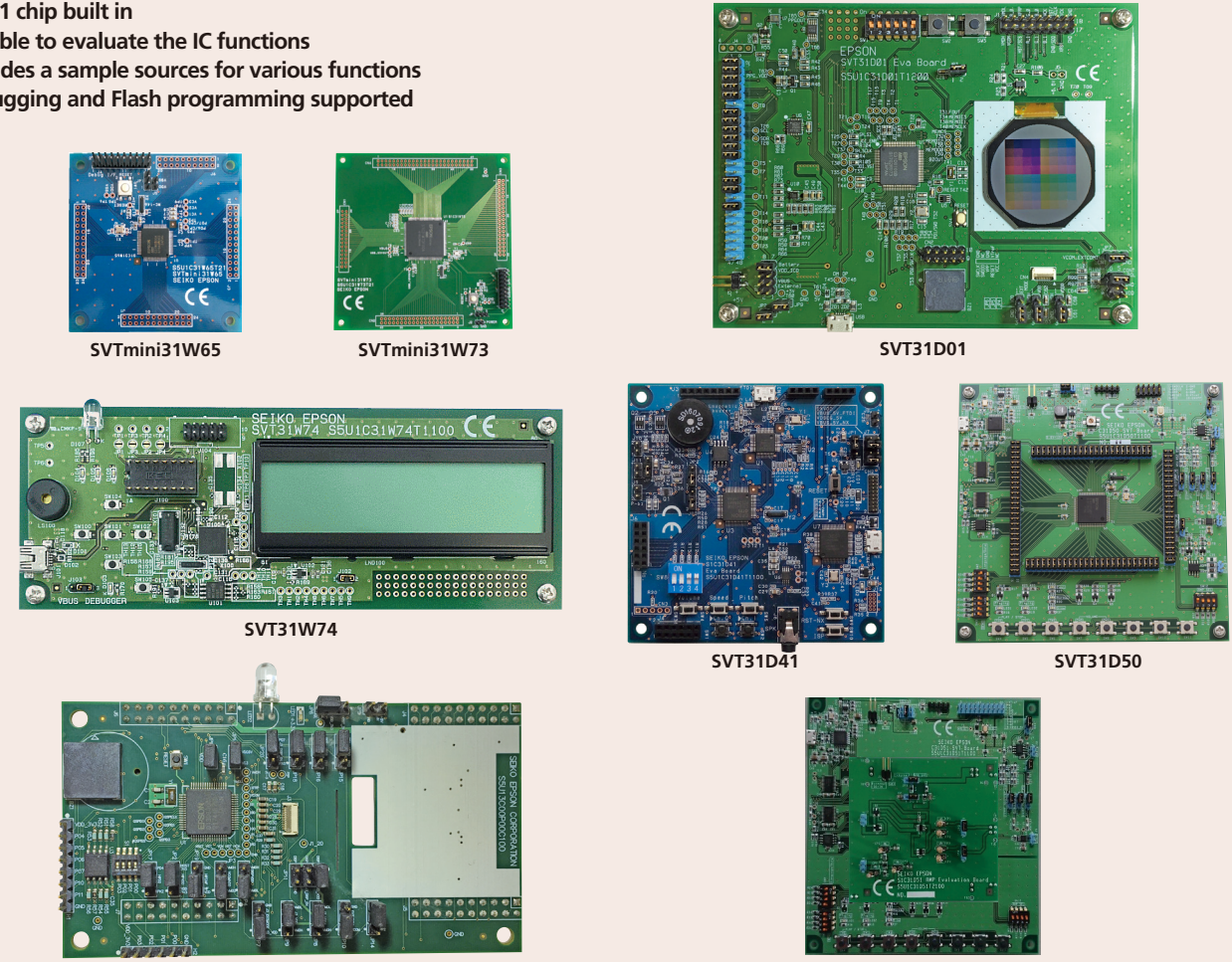

SVTmini31W65 **SVTmini31W73** **SVT31D01**

SVT31W74 **SVT31D41** **SVT31D50**

SVT13C00 **SVT31D51**

Model Name	Product Name	Mounted Microcontroller Name	Remarks
SVTmini31W65	S5U1C31W65T2	S1C31W65	
SVTmini31W73	S5U1C31W73T2	S1C31W73	
SVT31W74	S5U1C31W74T1	S1C31W74	Dot matrix liquid crystal panel, Infrared LED, USB connector, Bridge Board
SVT31D01	S5U1C31D01T1	S1C31D01	Color memory display, Acceleration gyro sensor, Pulse sensor, Bridge Board
SVT31D50	S5U1C31D50T1	S1C31D50	AMP (class AB, class D), SPI-Flash (8MB)
SVT13C00	S5U13C00K00C	S1D13C00	Color memory display, Bridge Board for connecting to Host CPU
SVT31D51	S5U1C31D51T1 (Mother Board)	S1C31D51	AMP (class AB, class D), SPI-Flash (8MB)
	S5U1C31D51T2 (Daughter Board)	-	Buzzer drive circuit
SVT31D41	S5U1C31D41T1	S1C31D41	Debugger function (DAPLink), AMP (class D), Buzzer drive circuit, Electromagnetic buzzer, Direct sensor module plug-in socket

3rd Party tool inquiries

Integrated Development Environment, Debug Probe

 IAR Systems K.K.
www.iar.com

Debug & Trace Probes, Flasher / In-Circuit Programmers

 **SEGGER**
The Embedded Experts

SEGGER Microcontroller GmbH
www.segger.com

GNU17 package

Optimized C compiler supporting 16MB space
Assembler, linker and ANSI library
GUI-based debugger
Eclipse integrated environment

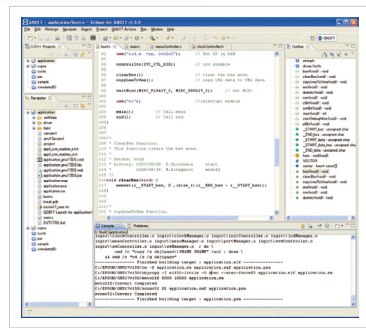

ICD mini

On-chip ICE, S1C17 Family products are supported.
Connect with the target board with 4 pins at minimum (3 signal pins and 1 GND pin).
Includes execution time measurement function.
Uses USB bus power.
Can be used as a Multi Programmer.
Includes firmware update function.
Power supply function for target devices of 3.3V .



Ver 3.0

GNU17



USB cable



ICD mini (SSU1C17001H)

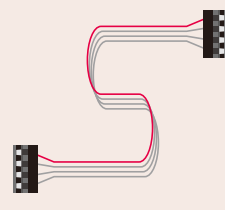

10-line cable (DCLK, DSIO, DST2, GND)

Starter / Beginner

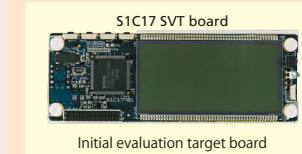

Initial evaluation target board

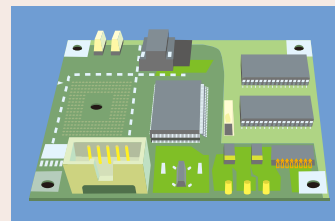

Target board for product development

Development support tool (Software simulator)

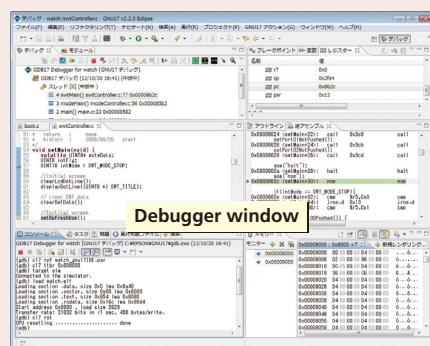

- Simulatable on PC including the LCD display, without using external debugging hardware or using an actual chip, it is possible to simulate only the LCD display (Custom-made LCD Panels can be created)
- Ability to show various data at the same time in multiple windows
- Ability to execute frequently using commands from the tool bar or menus
- Function of displaying C source, program code and symbols using disassembler
- Consecutive program execution and 3 types of step executions
- 3 types of break functions
- Trace and coverage functions
- Automatic command execution using command files

Development support tool (Evaluation board)

- S1C17 chip built in
- Possible to evaluate the IC functions
- Provides a sample software for various functions
- Debugging and Flash programming supported

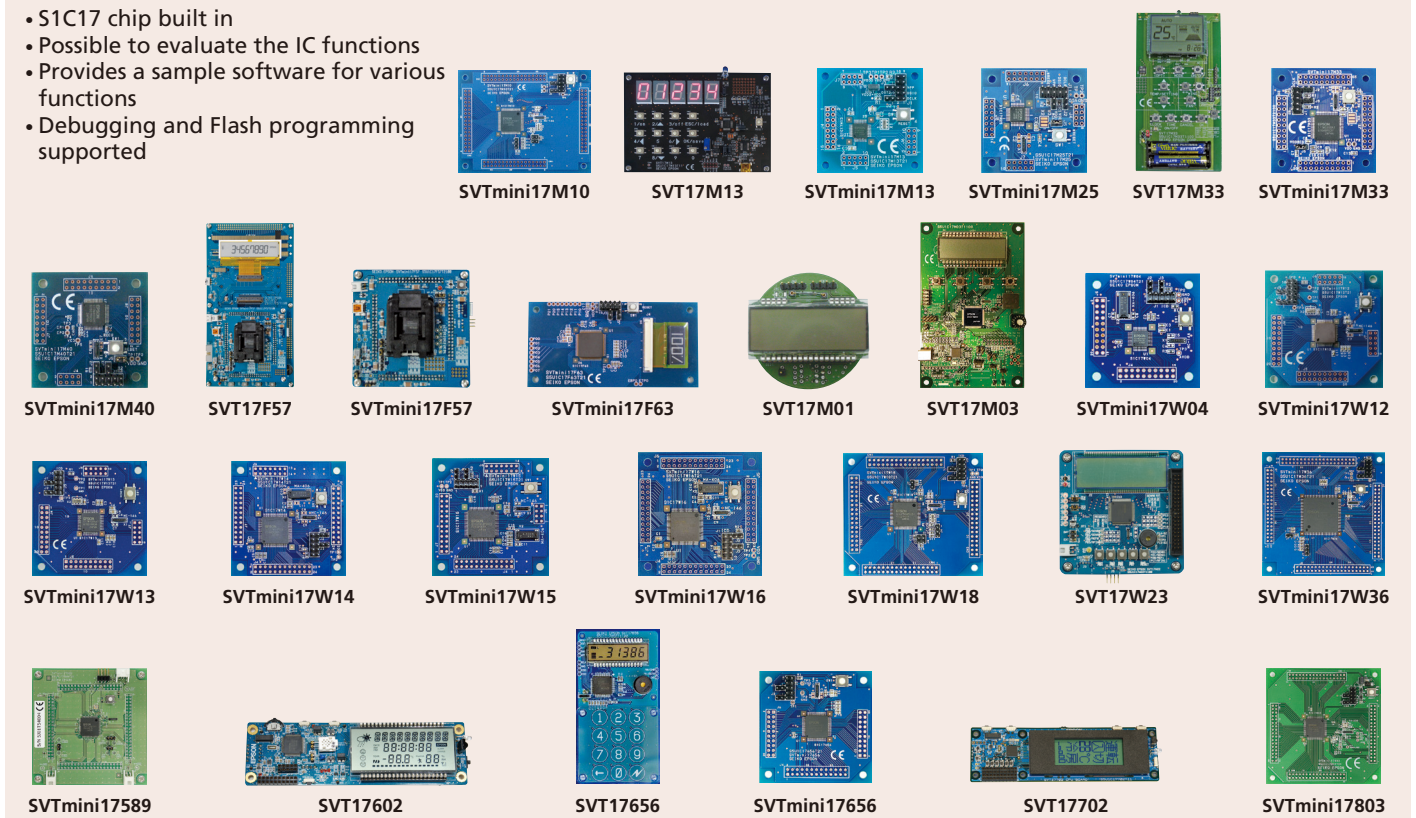

Model Name	Product Name	Mounted Microcontroller Name	Remarks
SVT17F57	S5U1C17F57T11	S1C17F57	Segment EPD panel
SVTmini17F57	S5U1C17F57T21	S1C17F57	
SVTmini17F63	S5U1C17F63T21	S1C17F63	Segment EPD panel
SVT17M01	S5U1C17M01T11	S1C17M01	LCD panel, MR Sensor with EEPROM
SVT17M03	S5U1C17M03T11	S1C17M03	Digital multimeter reference board
SVTmini17M10	S5U1C17M10T21	S1C17M10	
SVT17M13	S5U1C17M13T11	S1C17M13	7 seg LED 5 digits, EEPROM, Infrared LED, Key matrix 3x4
SVTmini17M25	S5U1C17M25T21	S1C17M25	
SVT17M33	S5U1C17M33T11	S1C17M33	Reference board of remote controller
SVTmini17M33	S5U1C17M33T21	S1C17M33	
SVTmini17M40	S5U1C17M40T21	S1C17M40	
SVTmini17M13	S5U1C17M13T21	S1C17M13	
SVTmini17W04	S5U1C17W04T21	S1C17W04	
SVTmini17W12	S5U1C17W12T21	S1C17W12	
SVTmini17W13	S5U1C17W13T21	S1C17W13	
SVTmini17W14	S5U1C17W14T21	S1C17W14	
SVTmini17W15	S5U1C17W15T21	S1C17W15	
SVTmini17W16	S5U1C17W16T21	S1C17W16	
SVTmini17W18	S5U1C17W18T21	S1C17W18	
SVT17W23	S5U1C17W23T11	S1C17W23	LCD panel, Piezoelectric buzzer
SVTmini17W36	S5U1C17W36T21	S1C17W36	
SVTmini17S89	S5U1C17S89T21	S1C17S89	
SVT17602	S5U1C17602T11	S1C17602	LCD panel, Remote control transmitter and receiver, Thermal/Humidity/Illuminance sensor
SVT17656	S5U1C17656T11	S1C17656	LCD panel, Capacitive touch button, Piezoelectric buzzer
SVTmini17656	S5U1C17656T21	S1C17656	
SVT17702	S5U1C17702T11	S1C17702	LCD panel, Remote control transmitter and receiver
SVTmini17803	S5U1C17803T21	S1C17803	

■ If you procure written products from a Epson dealer

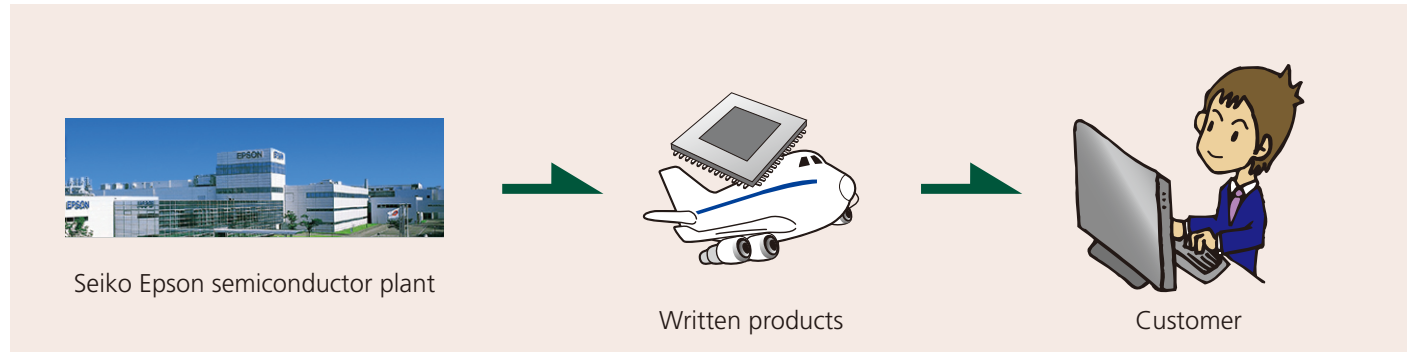

■ If you write to flash memory on your side (Single writing)

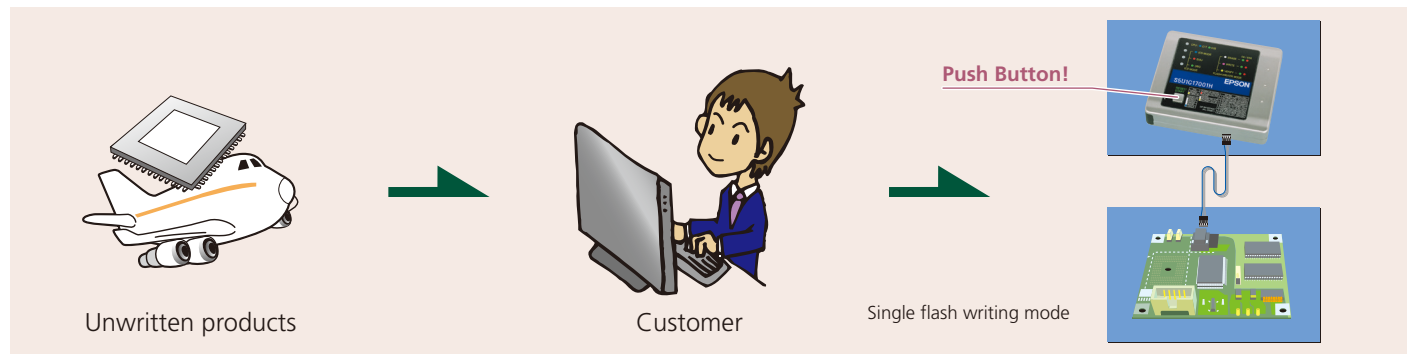

■ If you write to flash memory on your side (Simultaneous multiple writing)

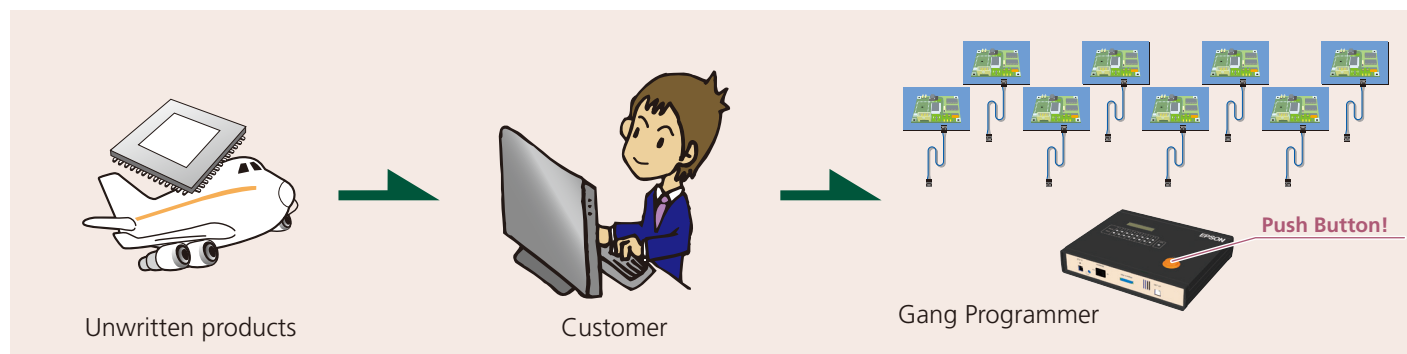
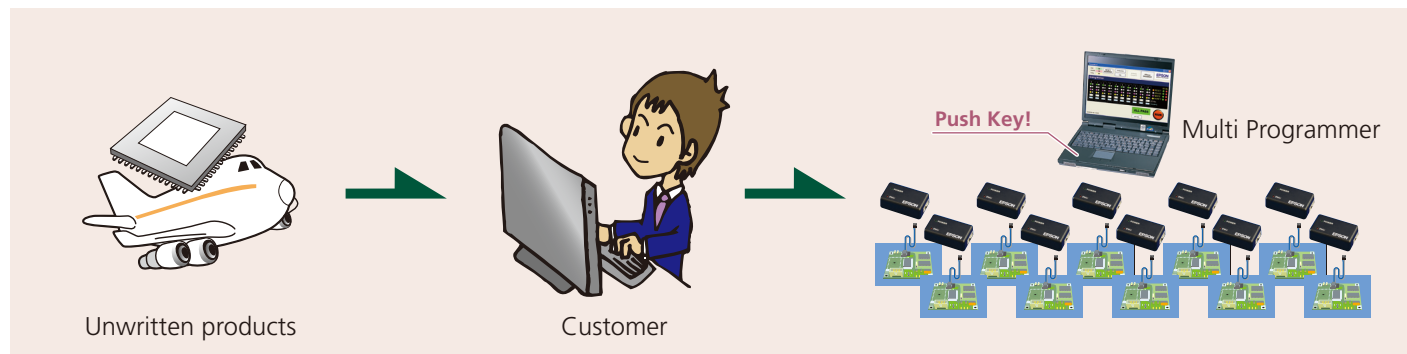

■ On-board writing tools and environments

Compatible models: S1C17Family(Single writing)

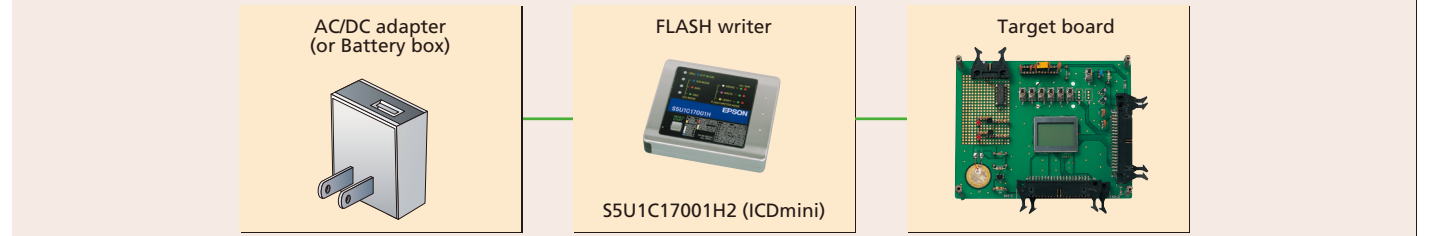

- A single S5U1C17001H2 (ICDmini) unit operates as an on-chip flash writer. Simply by pressing a button, user data previously saved in the ICDmini can be written to the internal flash ROM on the target board, or the flash ROM connected to the external bus.
- You can enjoy on-board programming easily at any location where a 5V power supply is available.
- * Power supply to the target board may be required separately.
- * The product does not include the target board, and AC adapter or battery box to supply power to USB terminals.

Compatible models: S1C17Family(Simultaneous multiple writing)

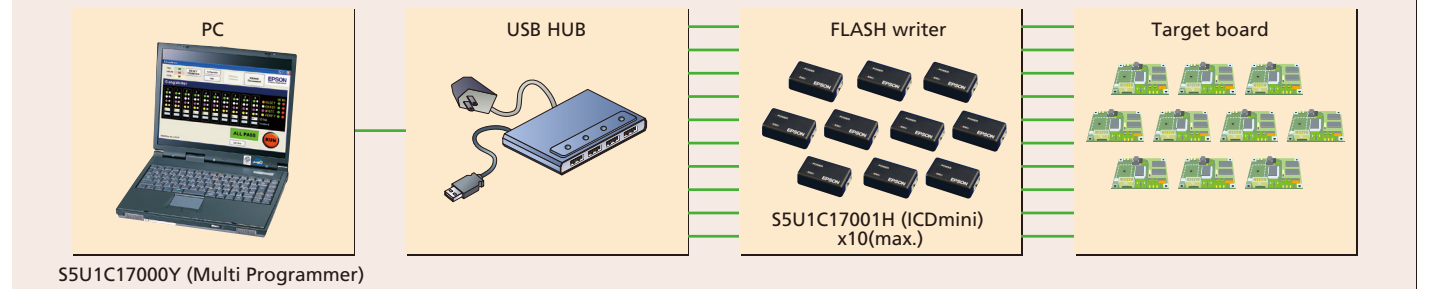

- Up to 10 units of the S5U1C17001H (ICDmini) can be used to construct an environment enabling user data to be downloaded simultaneously to multiple targets.
- The S5U1C17000Y, Multi Programmer software that controls the ICDmini, provides user-friendly screen and simple operation.
- * Power supply to the target board may be required separately.
- * The product does not include the target board, PC and the USB hub operating on self-power.

Compatible models: S1C17Family(Simultaneous multiple writing)













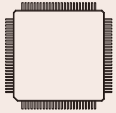

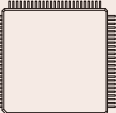

- A single S5U1C1700W unit downloads user data simultaneously to maximum 8 targets.
- SD card is used to input user data, and the operating status can be checked by LCD, LED and buzzer.
- A serial number writing function is also built-in.

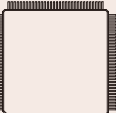
Compatible models: S1C31Family(Single writing)

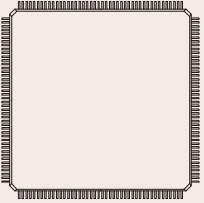

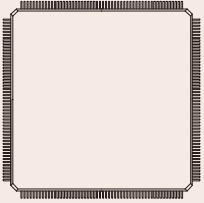
- SEGGER J-Link or Flasher / Any debug probe or flash programmer that supports J-Flash software tool can be used.

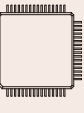

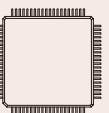

QFP & TQFP & SQFN

PKG type/Pin count	Body size (mm)	Lead pitch (mm)	PKG type/Pin count	Body size (mm)	Lead pitch (mm)
SQFN4-24 (P-VQFN024-0404-0.50) 	4 X 4 X 1.0	0.5	QFP14-100 (P-LQFP100-1212-0.40) 	12 X 12 X 1.7	0.4
SQFN5-32 (P-VQFN032-0505-0.50) 	5 X 5 X 1.0	0.5	QFP15-100 (P-LQFP100-1414-0.50) 	14 X 14 X 1.7	0.5
TQFP12-32 (P-TQFP032-0707-0.80) 	7 X 7 X 1.2	0.8	TQFP15-100 (P-TQFP100-1414-0.50) 	14 X 14 X 1.2	0.5
QFP12-48 (P-LQFP048-0707-0.50) 	7 X 7 X 1.7	0.5	TQFP15-128 (P-TQFP128-1414-0.40) 	14 X 14 X 1.2	0.4
SQFN7-48 (P-VQFN048-0707-0.50) 	7 X 7 X 1.0	0.5	QFP21-176 (P-LQFP176-2424-0.50) 	24 X 24 X 1.7	0.5
TQFP12-48 (P-TQFP048-0707-0.50) 	7 X 7 X 1.2	0.5	QFP21-216 (P-LQFP216-2424-0.40) 	24 X 24 X 1.7	0.4
SQFN9-64 (P-VQFN064-0909-0.50) 	9 X 9 X 1.0	0.5			
QFP13-64 (P-LQFP064-1010-0.50) 	10 X 10 X 1.7	0.5			
TQFP13-64 (P-TQFP064-1010-0.50) 	10 X 10 X 1.2	0.5			
QFP14-80 (P-LQFP080-1212-0.50) 	12 X 12 X 1.7	0.5			

WCSP

PKG type/Pin count	Body size (mm)	Ball pitch (mm)
WCSP-96 (S1C31D01) 	4.45 X 4.45 X 0.7	0.4

Compact BGA (PFBGA) & Thin type BGA (VFBGA)

PKG type/Pin count	Body size (mm)	Ball pitch (mm)
VFBGA5H-81 (P-VFBGA-081-0505-0.50) 	5 X 5 X 1.0	0.5
VFBGA10H-180 (P-VFBGA-180-1010-0.65) 	10 X 10 X 1.0	0.65
VFBGA8H-181 (P-VFBGA-181-0808-0.50) 	8 X 8 X 1.0	0.5
VFBGA10H-240 (P-VFBGA-240-1010-0.50) 	10 X 10 X 1.0	0.5

QFP

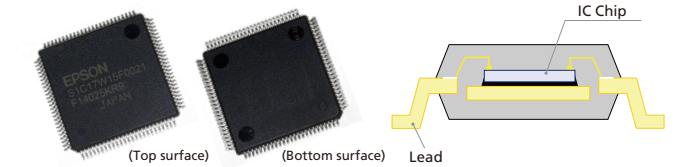

SQFN

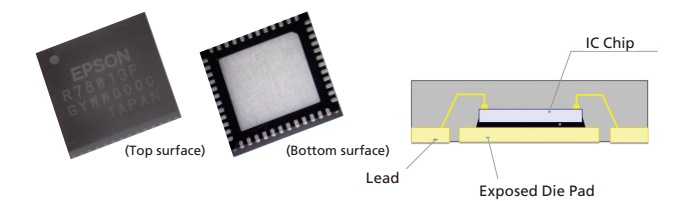

WCSP

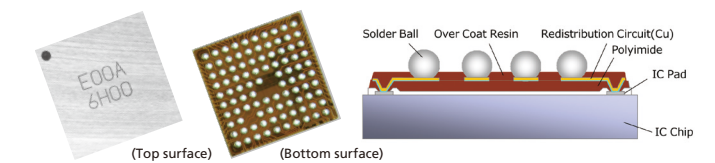

Thin type BGA (VFBGA)

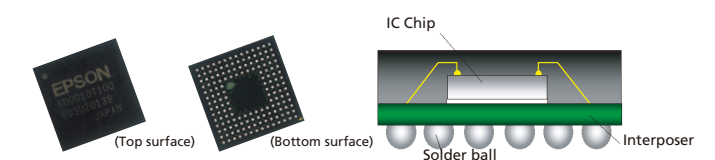

global.epson.com/products_and_drivers/semicon/products/micro_controller/

On the Epson MCU website, you can access a variety of information required for device selection and design development.

The screenshot shows the Epson website's product page for microcontrollers. It features a navigation bar with 'EPSON' and a search bar. Below the navigation, there are tabs for 'General', 'Arm', '16bit', 'Parametric Search', and 'To get What's New Info by email'. The main content area includes a 'Microcontrollers' section with a 'Sales & Support' button. A 'Pickup' section highlights a 'For Measuring Equipment Specialized MCU' and a 'Voice Data Creation Tool' for adding voice guidance. A 'Product lineup' section shows '16bit' and 'Arm' options. At the bottom, a 'CPU Core Lineup' diagram illustrates the relationship between the S1C17 Family (16-bit CPU) and the S1C31 Family (Arm Cortex-M0+), showing various sub-series like S1C17W00, S1C17500, S1C17600, S1C17700, and S1C17800, along with their specific features and performance levels.

Downloadable information

- Hardware Development Tool
- Software Development Tool
- Application Note
- Sample Program
- MP Support Tool

Microcontrollers Parametric Search

It's useful for your model selection of microcontrollers. You can download Data sheets, Technical manuals and Manual errata sheets.

The screenshot displays the 'Parametric Search' tool on the Epson website. It includes a search bar and a 'Sales & Support' button. Below the search bar, there are filters for 'Setting', 'Clear', and 'Compare'. A table lists various microcontroller models with their specifications. The table has columns for 'Products', 'CPU', 'Segment', 'LCD Driver', 'LCD Controller', 'Other Driver', 'High-speed clock (Max.)', 'Low-speed clock (Typ.)', and 'Built-in oscillator (Typ.)'. The table lists models like S1C17W03, S1C17W04, S1C17W12, S1C17W13, and S1C17W14, along with their respective CPU core counts, clock speeds, and oscillator frequencies.

Downloadable information

- Data sheets
- Technical manuals
- Manual errata sheets

NOTICE: PLEASE READ THE FOLLOWING NOTICE CAREFULLY BEFORE USING THIS DOCUMENT

The contents of this document are subject to change without notice.

1. This document may not be copied, reproduced, or used for any other purpose, in whole or in part, without the consent of the Seiko Epson Corporation ("Epson").
2. Before purchasing or using Epson products, please contact our sales representative for the latest information and always be sure to check the latest information published on Epson's official web sites and other sources.
3. Information provided in this document such as application circuits, programs, usage, etc., are for reference purposes only. Using the application circuits, programs, usage, etc. in the design of your equipment or systems is your own responsibility. Epson makes no guarantees against any infringements or damages to any third parties' intellectual property rights or any other rights resulting from the information. This document does not grant you any licenses, intellectual property rights or any other rights with respect to Epson products owned by Epson or any third parties.
4. Epson is committed to constantly improving quality and reliability, but semiconductor products in general are subject to malfunction and failure. By using Epson products, you shall be responsible for your hardware. Software and systems must be designed well enough to prevent death or injury as well as any property damage even if any of the malfunctions or failures might be caused by Epson products. When designing your products using Epson products, please be sure to check and comply with the latest information regarding Epson products (this document, specifications, data sheets, manuals, Epson's web site, etc.). When using the information included above materials such as product data, charts, technical contents, programs, algorithms and application circuit examples, you shall evaluate your products both on a stand-alone basis as well as within your overall systems. You shall be solely responsible for deciding whether or not to adopt and use Epson products.
5. Epson has prepared this document and programs provided in this document carefully to be accurate and dependable, but Epson does not guarantee that the information and the programs are always accurate and complete. Epson assumes no responsibility for any damages which you incur due to misinformation in this document and the programs.
6. No dismantling, analysis, reverse engineering, modification, alteration, adaptation, reproduction, etc., of Epson products is allowed.
7. Epson products have been designed, developed and manufactured to be used in general electronic applications (office equipment, communications equipment, measuring instruments, home electronics, etc.) ("General Purpose") and applications which is individually listed in this document or designated by Epson ("Designated Purpose"). Epson products are NOT intended for any use beyond the General Purpose and Designated Purpose uses that requires particular/higher quality or reliability in order to refrain from causing any malfunction or failure leading to death, injury, serious property damage or severe impact on society, including, but not limited to those listed below ("Particular Purpose"). Therefore, you are advised to use Epson products only for General Purpose and Designated Purpose uses. Should you desire to buy and use Epson products for a Particular Purpose, Epson makes no warranty and disclaims with respect to Epson products, whether express or implied, including without limitation any implied warranty of merchantability or fitness for any Particular Purpose. Please be sure to contact our sales representative and obtain approval in advance.

[Examples of Particular Purpose]

 - Space equipment (artificial satellites, rockets, etc.) /
 - Transportation vehicles and their control equipment (automobiles, aircraft, trains, ships, etc.) /
 - Medical equipment / Relay equipment to be placed on ocean floor /
 - Power station control equipment / Disaster or crime prevention equipment / Traffic control equipment / Financial equipment

Other applications requiring similar levels of reliability as those listed above. Please be sure to contact our sales representative for details of the other applications.
8. Epson products listed in this document and our associated technologies shall not be used in any equipment or systems that laws and regulations in Japan or any other countries prohibit to manufacture, use or sell. Furthermore, Epson products and our associated technologies shall not be used for developing weapons of mass destruction, or any other military purposes or applications. If exporting Epson products or our associated technologies, you shall comply with the Foreign Exchange and Foreign Trade Control Act in Japan, Export Administration Regulations in the U.S.A. (EAR) and other export-related laws and regulations in Japan and any other countries and follow the required procedures as provided by the relevant laws and regulations.
9. Epson assumes no responsibility for any damages (whether direct or indirect) caused by or in relation with your non-compliance with the terms and conditions in this document.
10. Epson assumes no responsibility for any damages (whether direct or indirect) incurred by any third party that you assign, transfer, loan, etc., Epson products to.
11. For more details or other concerns about this document, please contact our sales representative.
12. Company names and product names listed in this document are trademarks or registered trademarks of their respective companies.

Evaluation board/kit and Development tool important notice

1. Epson evaluation board/kit or development tool is designed for use for engineering evaluation, demonstration, or development purposes only. Do not use it for other purposes. It is not intended to meet the requirements of design for finished products.
2. Epson evaluation board/kit or development tool is intended for use by an electronic engineer and is not a consumer product. The user should use it properly and in a safe manner. Epson does not assume any responsibility or liability of any kind of damage and/or fire caused by the use of it. The user should cease to use it when any abnormal issue occurs even during proper and safe use.
3. The part used for Epson evaluation board/kit or development tool may be changed without any notice.

©Seiko Epson Corporation 2024, All rights reserved.

[Registered trademarks, trademarks, and company names]

Design Compiler® : Synopsys Inc. in U.S.A.

NC-Verilog® : Cadence Design Systems Inc. in U.S.A.

SuperFlash® : Silicon Storage Technology, Inc., in the U.S.A.

Arm and Cortex are registered trademarks of Arm Limited (or its subsidiaries) in the US and/or elsewhere.

Other brand names and product names are trademarks or registered trademarks of their respective owners.

MMP Technology

Supply of this implementation of TPL's MMP technology does not convey a license nor imply a right under any patent, or any other industrial or intellectual property right of TPL, to use this implementation in any finished end-user final product. You are hereby notified that a license for such use is required from TPL. Contact: "mmp-licensing@tplgroup.net"

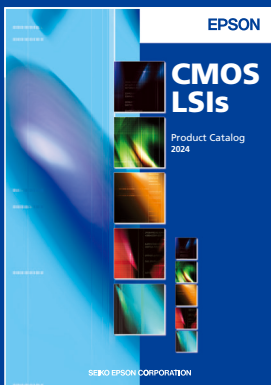

America

Epson America, Inc.

Headquarter:
3131 Katella Ave.
Los Alamitos, CA 90720, USA
Phone: +1-800-463-7766

San Jose Office:
2860 Zanker Road Suite 204
San Jose, CA 95134, USA
Phone: +1-800-463-7766

Europe

Epson Europe Electronics GmbH

Riesstrasse 15, 80992 Munich, Germany
Phone: +49-89-14005-0 FAX: +49-89-14005-110

Asia

Epson (China) Co., Ltd.

4th Floor, Tower 1 of China Central Place, 81 Jianguo Road, Chaoyang District, Beijing 100025 China
Phone: +86-10-8522-1199 FAX: +86-10-8522-1120

Shanghai Branch

Room 601-603, Building A One East, No.325 East Longhua Road, Shanghai 200023, China
Phone: +86-21-5330-4888 FAX: +86-21-5423-4677

Shenzhen Branch

Room 804-805, 8 Floor, Tower 2, Ali Center, No.3331 Keyuan South RD (Shenzhen bay), Nanshan District, Shenzhen 518054, China
Phone: +86-755-3299-0588 FAX: +86-755-3299-0560

Epson Taiwan Technology & Trading Ltd.

15F., No. 100, Songren Rd., Sinyi Dist., Taipei City 110, Taiwan
Phone: +886-2-8786-6688

Epson Singapore Pte., Ltd.

438B Alexandra Road, Block B Alexandra TechnoPark, #04-01/04, Singapore 119968
Phone: +65-6586-5500 FAX: +65-6271-7066

Epson Korea Co., Ltd.

10F Posco Tower Yeoksam, Teheranro 134 Gangnam-gu, Seoul, 06235, Korea
Phone: +82-2-3420-6695

Seiko Epson Corp. Sales & Marketing Division

MD Sales & Marketing Department

JR Shinjuku Miraina Tower, 4-1-6 Shinjuku, Shinjuku-ku, Tokyo 160-8801, Japan