

ON Semiconductor

Is Now

onsemi™

To learn more about onsemi™, please visit our website at
www.onsemi.com

onsemi and **onsemi** and other names, marks, and brands are registered and/or common law trademarks of Semiconductor Components Industries, LLC dba "**onsemi**" or its affiliates and/or subsidiaries in the United States and/or other countries. **onsemi** owns the rights to a number of patents, trademarks, copyrights, trade secrets, and other intellectual property. A listing of **onsemi** product/patent coverage may be accessed at www.onsemi.com/site/pdf/Patent-Marking.pdf. **onsemi** reserves the right to make changes at any time to any products or information herein, without notice. The information herein is provided "as-is" and **onsemi** makes no warranty, representation or guarantee regarding the accuracy of the information, product features, availability, functionality, or suitability of its products for any particular purpose, nor does **onsemi** assume any liability arising out of the application or use of any product or circuit, and specifically disclaims any and all liability, including without limitation special, consequential or incidental damages. Buyer is responsible for its products and applications using **onsemi** products, including compliance with all laws, regulations and safety requirements or standards, regardless of any support or applications information provided by **onsemi**. "Typical" parameters which may be provided in **onsemi** data sheets and/or specifications can and do vary in different applications and actual performance may vary over time. All operating parameters, including "Typicals" must be validated for each customer application by customer's technical experts. **onsemi** does not convey any license under any of its intellectual property rights nor the rights of others. **onsemi** products are not designed, intended, or authorized for use as a critical component in life support systems or any FDA Class 3 medical devices or medical devices with a same or similar classification in a foreign jurisdiction or any devices intended for implantation in the human body. Should Buyer purchase or use **onsemi** products for any such unintended or unauthorized application, Buyer shall indemnify and hold **onsemi** and its officers, employees, subsidiaries, affiliates, and distributors harmless against all claims, costs, damages, and expenses, and reasonable attorney fees arising out of, directly or indirectly, any claim of personal injury or death associated with such unintended or unauthorized use, even if such claim alleges that **onsemi** was negligent regarding the design or manufacture of the part. **onsemi** is an Equal Opportunity/Affirmative Action Employer. This literature is subject to all applicable copyright laws and is not for resale in any manner. Other names and brands may be claimed as the property of others.

TND318/D
Rev. 0, Apr-06



ON Semiconductor®



60 W Adapter Documentation Package

© 2006 ON Semiconductor.

Disclaimer: ON Semiconductor is providing this reference design documentation package "AS IS" and the recipient assumes all risk associated with the use and/or commercialization of this design package. No licenses to ON Semiconductor's or any third party's Intellectual Property is conveyed by the transfer of this documentation. This reference design documentation package is provided only to assist the customers in evaluation and feasibility assessment of the reference design. It is expected that users may make further refinements to meet specific performance goals.

1 Overview

This reference document describes a built-and-tested, GreenPoint™ solution for a 60 W power adapter.

The reference design circuit consists of one single-sided 100 mm x 52 mm printed circuit board. Height is 25 mm.

An overview of the entire circuit is provided by Figure 1. As shown in that figure, ON Semiconductor devices are available for every block of adapter; and by judicious choice of design tradeoffs, optimum performance is achieved at minimum cost.

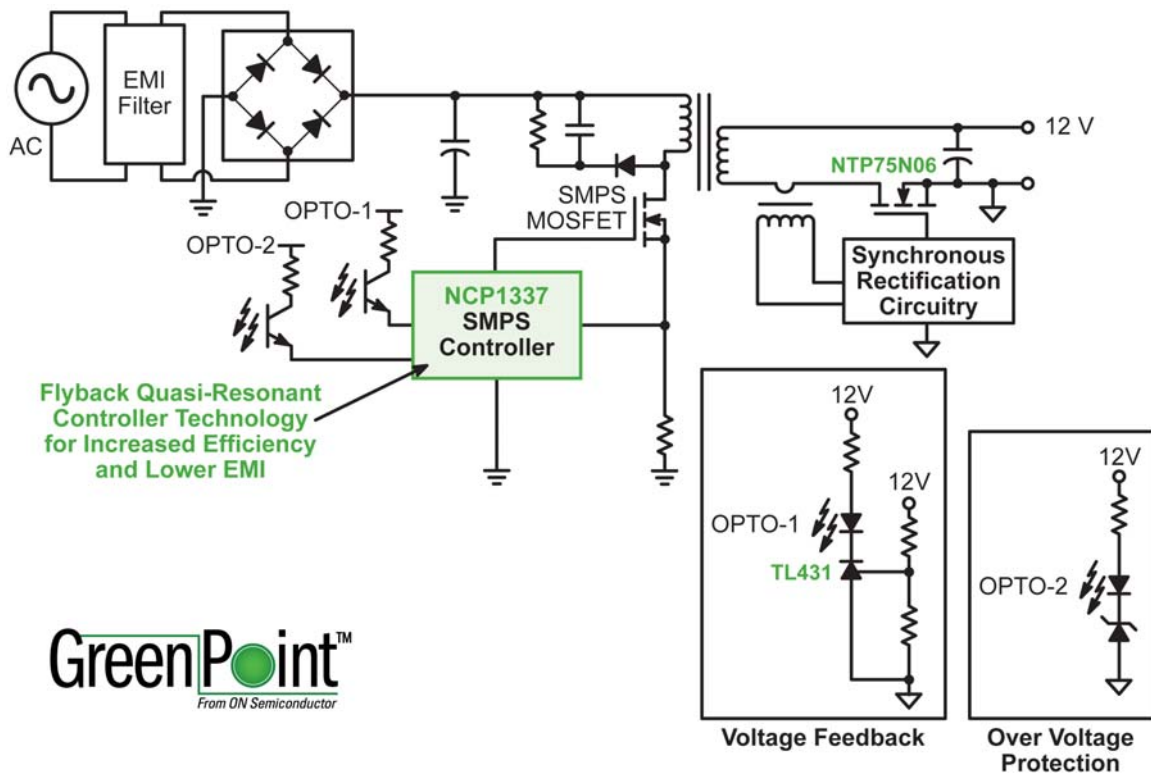

Figure 1

2 Introduction

This design using NCP1337 offers a perfect solution for portable DVD , LCD TV, or monitor and notebook adapter applications. This adapter provides effective protection functions such as over-load protection, over-voltage protection, short-circuit protection and brown-out protection. Thanks to the quasi-resonant operation and synchronous rectifier, this adapter has high efficiency and improved EMI performance. The standby consumption is lower because of the cycle skipping and soft ripple mode.

Regulatory requirements addressing low standby power consumption and efficiency in active mode for external power supply (EPS) add extra constraints in the design of the adapter.

These requirements target two issues:

- Get rid of the losses in a no load situation (e.g., when the notebook adapter is plugged in, even when it is not connected to the computer).
- Achieve a good average efficiency during various active mode load conditions (25%, 50%, 75% and 100%).

Many regulations have been proposed around the world. Hereafter is the list of some of the most important ones:

- Energy Star: applicable in the US and international partners
 - Energy Efficiency Criteria for active mode

Nameplate Output Power (P_{no})	Minimum Average Efficiency in Active Mode (expressed as decimal)
0 to < 1 Watt	$\geq 0.49 * P_{no}$
>1 and ≤ 49 Watts	$\geq (0.09 * \ln(P_{no})) + 0.49$
> 49 Watts	≥ 0.84

- Energy Consumption Criteria for No Load

Nameplate Output Power (P_{no})	Minimum Average Efficiency in Active Mode (expressed as decimal)
0 to <10 Watts	≤ 0.5 Watt
≥ 10 to ≤ 250 Watts	≤ 0.75 Watt

- California Energy Commission:
 - Effective January 1, 2007

Nameplate Output	Minimum Efficiency in Active Mode
0 to < 1 Watt	0.49 * Nameplate Output
>1 and ≤ 49 Watts	0.09 * Ln(Nameplate Output) + 0.49
> 49 Watts	0.84
Maximum Energy Consumption in No-Load Mode	
0 to <10 Watts	0.5 Watt
≥10 to ≤ 250 Watts	0.75 Watt
Where Ln (Nameplate Output) = Natural Logarithm of the nameplate output expressed in Watts	

- Effective July 1, 2008

Nameplate Output	Minimum Efficiency in Active Mode
0 to < 1 Watt	0.5 * Nameplate Output
>1 and ≤ 51 Watts	0.09 * Ln(Nameplate Output) + 0.5
> 51 Watts	0.85
Maximum Energy Consumption in No-Load Mode	
Any output	0.5 Watt
Where Ln (Nameplate Output) = Natural Logarithm of the nameplate output expressed in Watts	

- European Union Code of Conduct
 - No-load Power Consumption

Rated Output Power	No-load power consumption	
	Phase 1 1.1.2005	Phase 2 1.1.2007
> 0.3 W and < 15 W	0.30 W	0.30 W
> 15 W and < 50 W	0.50 W	0.30 W
> 50 W and < 60 W	0.75 W	0.30 W
> 60 W and < 150 W	1.00 W	0.50 W

- Energy-Efficiency Criteria for Active Mode for Phase 1 (for the period 1.1. 2005 to 31.12 2006)

Rated Output Power	Minimum Four Point Average (see Annex) or 100 % Load Efficiency in Active Mode
0 < W < 1.5	30
1.5 < W < 2.5	40
2.5 < W < 4.5	50
4.5 < W < 6.0	60
6.0 < W < 10.0	70
10.0 < W < 25.0	75
25.0 < W < 150.0	80

- Energy-Efficiency Criteria for Active Mode for Phase 2 (valid after 1.1.2007)

Nameplate Output Power (P_{no})	Minimum Four Point Average (see Annex) or 100 % Load Efficiency in Active Mode (expressed as a decimal)²
0 < W < 1	$\geq 0.49 * P_{no}$
1 < W < 49	$\geq (0.09 * \ln(P_{no})) + 0.49$
49 < W < 150	$\geq 0.84^3$

Notes

2 “Ln” refers to the natural logarithm. The algebraic order of operations requires that the natural logarithm calculation be performed first and then multiplied by 0.09, with the resulting output added to 0.49. (b) An efficiency of 0.84 in decimal form corresponds to the more familiar value of 84% when expressed as a percentage.

3 Power supplies that have a power factor correction (PFC) to comply with EN61000-3-2 (above 75 W input power) have a 0.04 (4%) allowance, accordingly the minimum on mode load efficiency (100% or averaged) is relaxed to 0.80 (80%).

- Korea:
 - External Power Supply - No load: 0.8 W
 - Battery Charger - No load: 0.8 W

This document provides a solution to address the design challenges brought about by these regulations: requirements for standby power reduction and active mode energy efficiency increase at a reasonable cost.

3 Adapter Requirements

More and more high-power adapters are being used in high end applications such as LCD monitors, LCD TVs, and notebook computers. These applications need adapters that are compliant with world-wide energy regulations, deliver high efficiency, and provide complete protection functions. In LCD TV applications, lower radio interference is also important.

Typically, in these applications, the output power range is 45 W to 60 W. No active PFC is needed. The input is universal voltage, and the output voltage is around 12 V.

4 Limitations of existing solutions

In many existing solutions, it is difficult to approach a most optimized design for adapters with minimum parts count and low cost. Brown out protection, over-load protection with input voltage compensation, latch-off or disable protection, and soft start function would add about 20 external parts around the controller. Therefore, the reliability and reproducibility of the adapter would be negatively impacted, due to the increase in the complexity of the design.

5 Overcoming limitations with NCP1337

NCP1337 combines all the requirements for adapter applications in a space-efficient SO-7 package. The NCP1337 combines a true current mode modulator and a demagnetization detector, which ensures full Borderline/Critical Conduction Mode in any load/line conditions, together with minimum drain voltage switching (Quasi-Resonant operation). The transformer core reset detection is done internally, without using any external signal, due to the Soxyless concept. The frequency is internally limited to 130 kHz, preventing the controller from operating above the 150 kHz CISPR-22 EMI starting limit.

By monitoring the feedback pin activity, the controller enters ripple mode as soon as the power demand falls below a predetermined level. As each restart is softened by an internal soft-start, and as the frequency cannot go below 25 kHz, no audible noise can be heard.

The NCP1337 also features an efficient protective circuit which, in the presence of an overcurrent condition, disables the output pulses and enters a safe burst mode, trying to restart. Once the default has gone, the device auto-recovers. Also included is a bulk voltage monitoring function (known as brown-out protection), an adjustable overpower compensation, and a V_{CC} OVP. Finally, an internal 4.0 ms soft-start eliminates the traditional startup stress.

The NCP1337 includes the following features:

- Free-Running Borderline/Critical Mode Quasi-Resonant Operation
- Current-Mode
- Soft Ripple Mode with Minimum Switching Frequency for Standby
- Auto-Recovery Short-Circuit Protection Independent of Auxiliary Voltage
- Overvoltage Protection
- Brown-Out Protection
- Two Externally Triggerable Fault Comparators (one for a disable function, and the other for a permanent latch)
- Internal 4.0 ms Soft-Start
- 500 mA Peak Current Drive Sink Capability
- 130 kHz Maximum Frequency
- Internal Leading Edge Blanking
- Internal Temperature Shutdown
- Direct Optocoupler Connection
- Dynamic Self-Supply with Levels of 12 V (On) and 10 V (Off)

6 Specifications

Parameter	Test Conditions	Min	Typ	Max	Unit
Input					
Voltage range		90		265	Vac
Frequency range		47		63	Hz
Brown out threshold		65		75	Vac
Brown out hysteresis			10		Vac
Input inrush current	Cold start 230 Vac			65	A
No-load input power	Input 240 Vac			0.3	W
Output					
Output voltage			12		V
Voltage total regulation	90 Vac to 265 Vac input and 0 to 5 A output			±2	%
Load output current	90 Vac to 265 Vac	0		5	A
Start-up overshoot	90 Vac to 265 Vac			10	%
Transient regulation	2.5 A to 5 A Step			300	mV
Transient recovery time	2.5 A to 5 A Step; Recovery to 1%			200	us
Ripple	20 MHz Bandwidth, Full Load			100	mV
Over current protection	90 Vac to 265 Vac	5.5		7	A
Over voltage protection	Open Voltage Feedback Loop	13.5	14	14.5	V
Total Output Power					
Continuous Output Power	Total power			60	W
Conducted EMI Margin	EN55022 class B	6			dB
Efficiency	Input 230 Vac, Full Load	88			%
Operation Temperature	Full Load, Free Air Convection cooling	0		40	°C

7 Reference Design Performance

No-load consumption

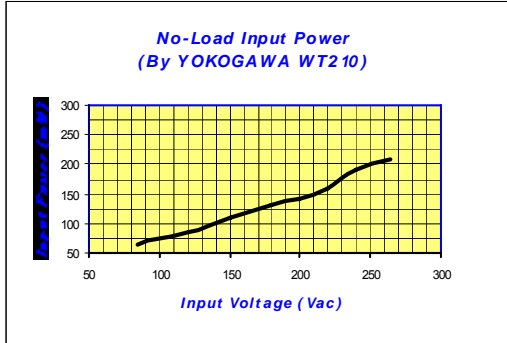

Output voltage 12.25 V; output current 0 A

Low load 0.5 W consumption

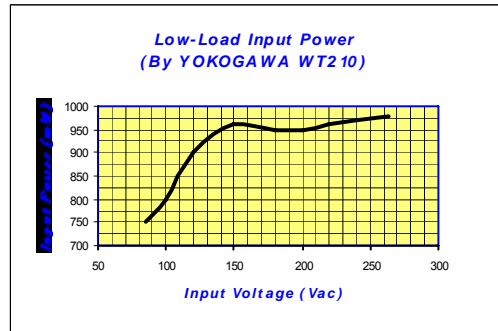

Output voltage 12.25 V; output current 42 mA

Efficiency

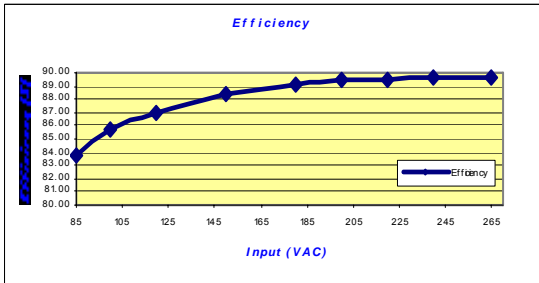

Efficiency vs input voltage at full load

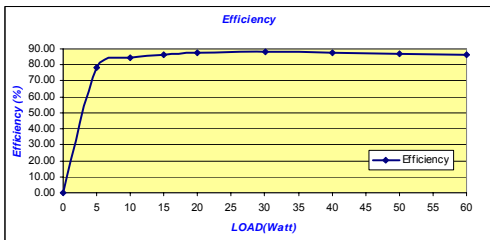

Efficiency vs Load at 110 Vac input

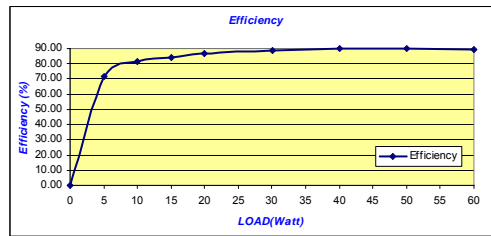

Efficiency vs Load at 220 Vac input

Voltage Waveform of MOSFET Q2 Drain @ full load

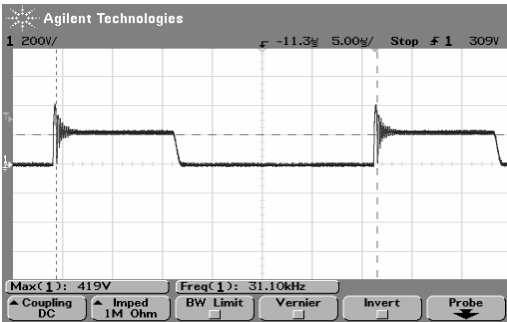

90 Vac input; Switching frequency 31 kHz

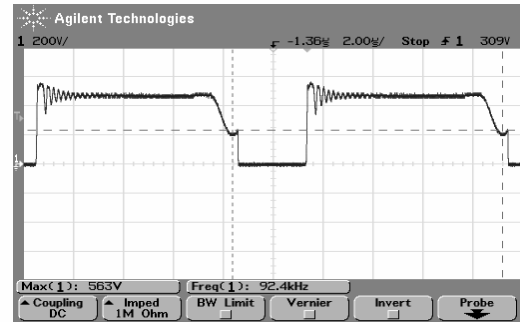

250 Vac input; switching frequency 92 kHz

Drive Waveform of MOSFET Q1 (Synchronous Rectifier) @ full load

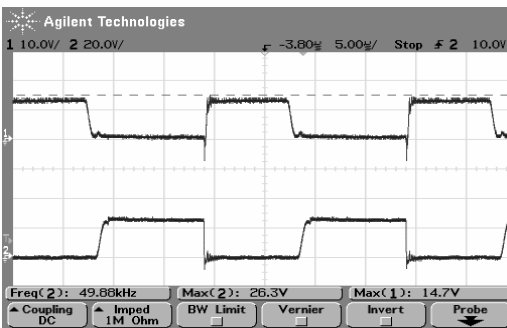

90 Vac input; CH1 Vgs; CH2 Vds

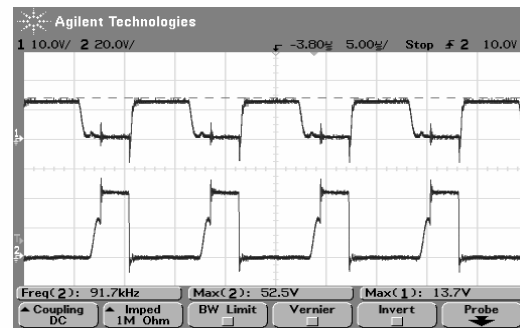

250 Vac input; CH1 Vgs; CH2 Vds

Vds of Q2 and Vcc Waveform @ Over load

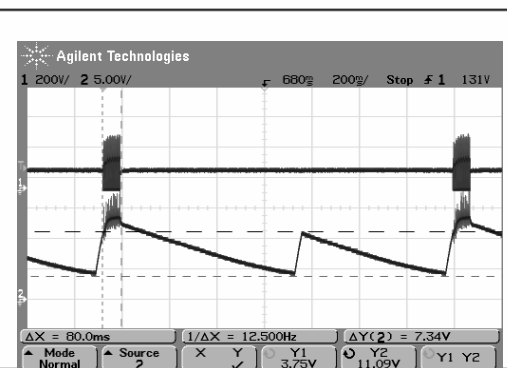

90 Vac input; Over load at 5.5 A; CH1 Vds; CH2 Vcc

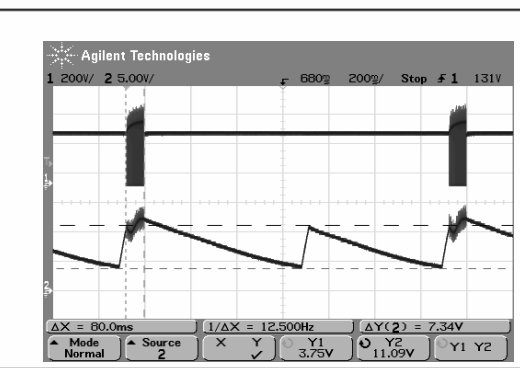

250 Vac input; Over load at 5.9 A; CH1 Vds; CH2 Vcc

Dynamic Load transient response @ Step load 2.5 A to 5 A to 2.5 A

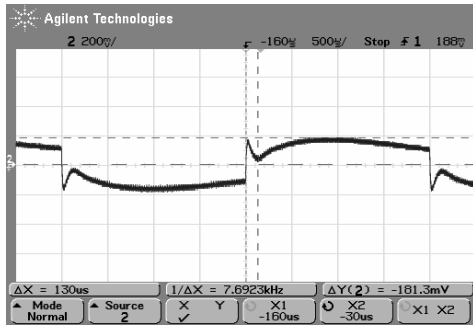

Input voltage 90 Vac

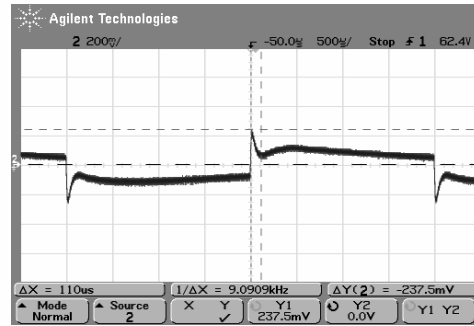

Input voltage 250 Vac

Over Voltage Protection (Voltage feedback open circuit mode) @ full load

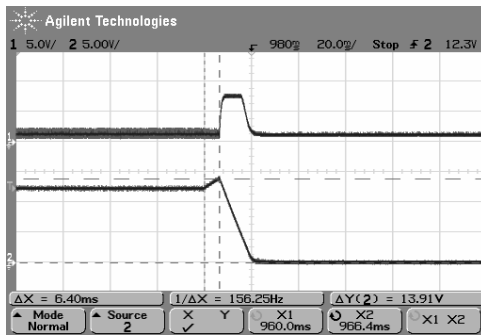

CH1: BO pin; CH2: Output (OVP 13.91 V)

EMI @ full load

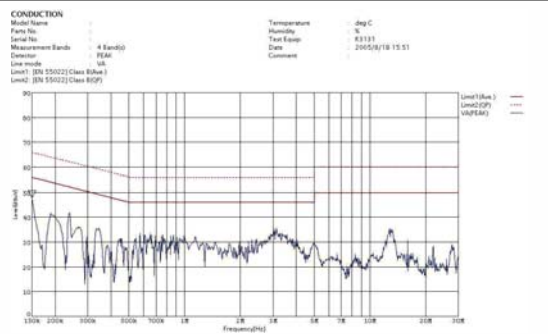

110 Vac input

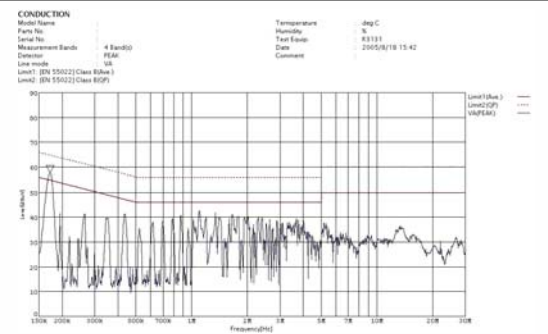

220 Vac input

8 Board Pictures

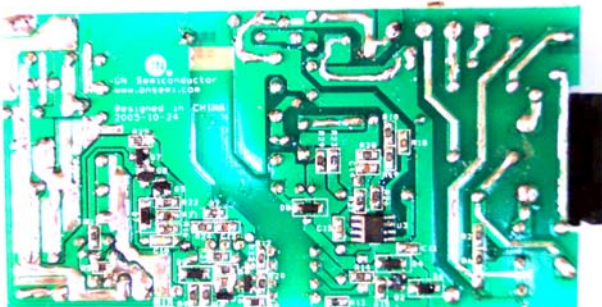
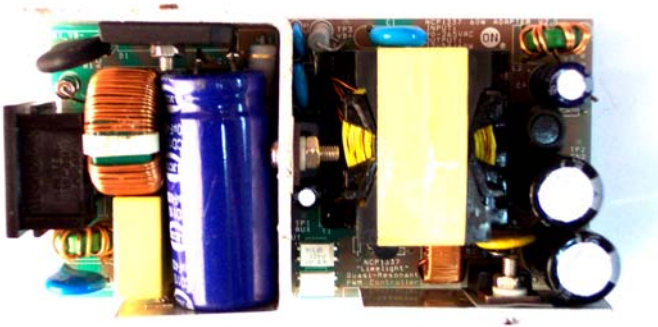

9 Schematic

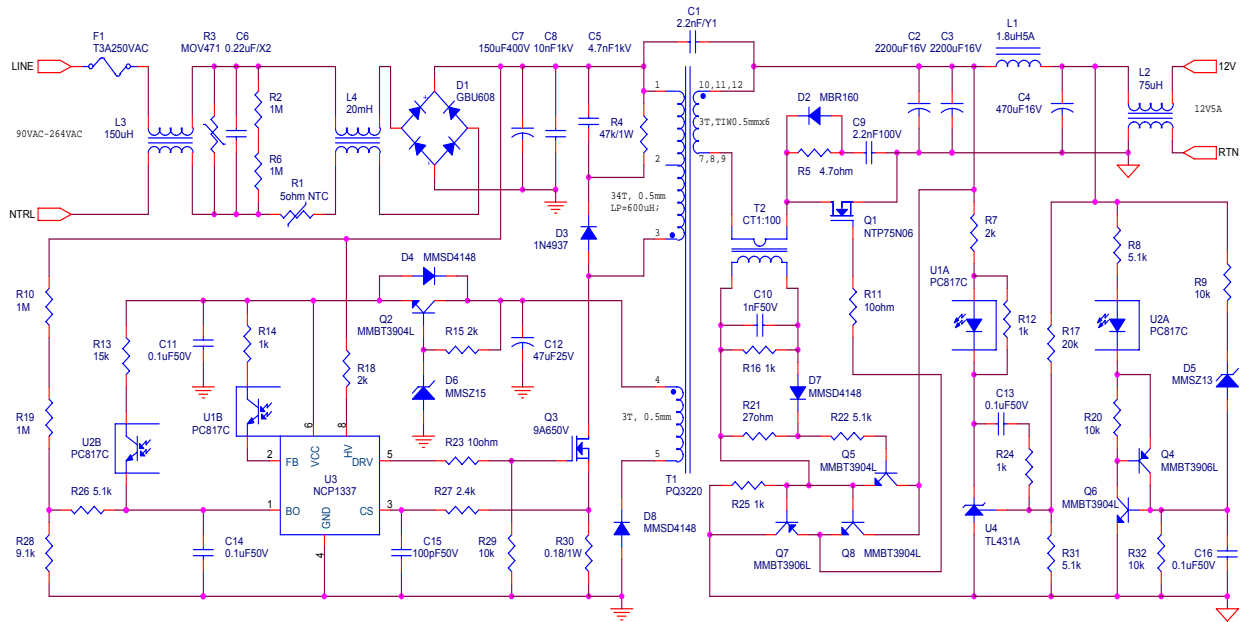

10 Board Layout

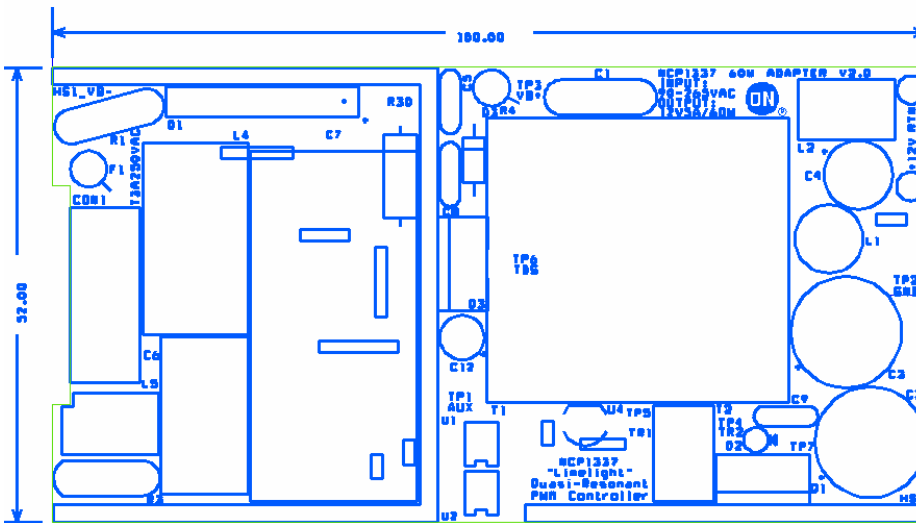

Assembly Drawing

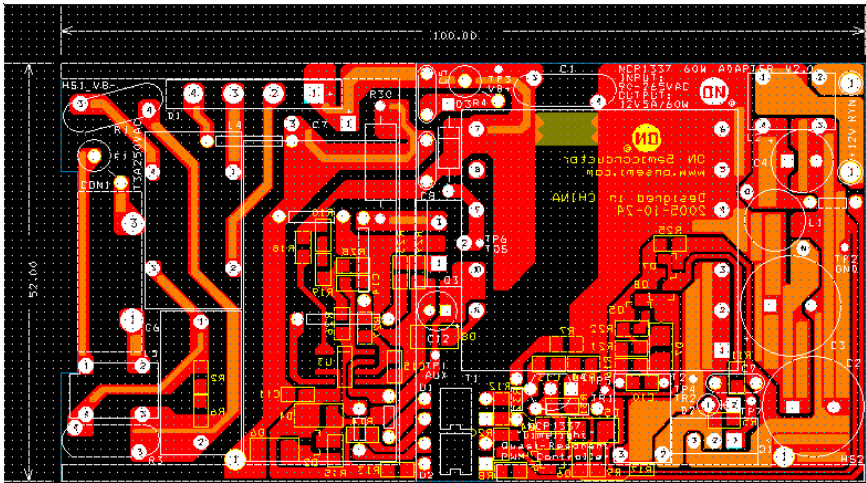

Global layer

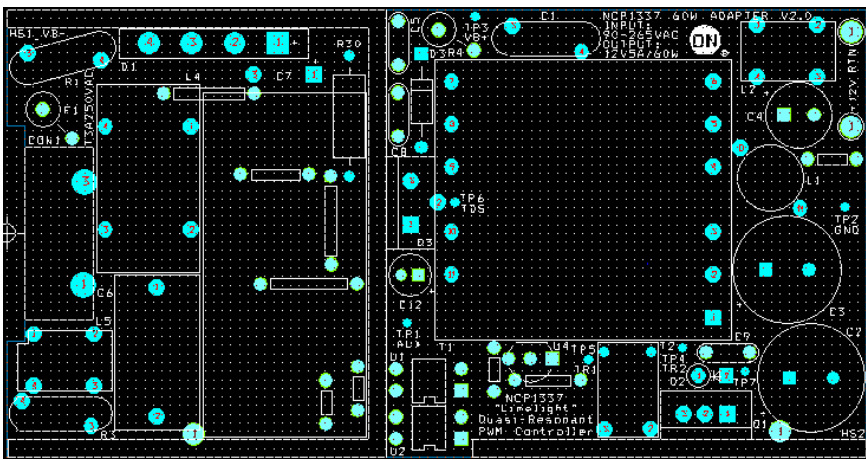

Top layer

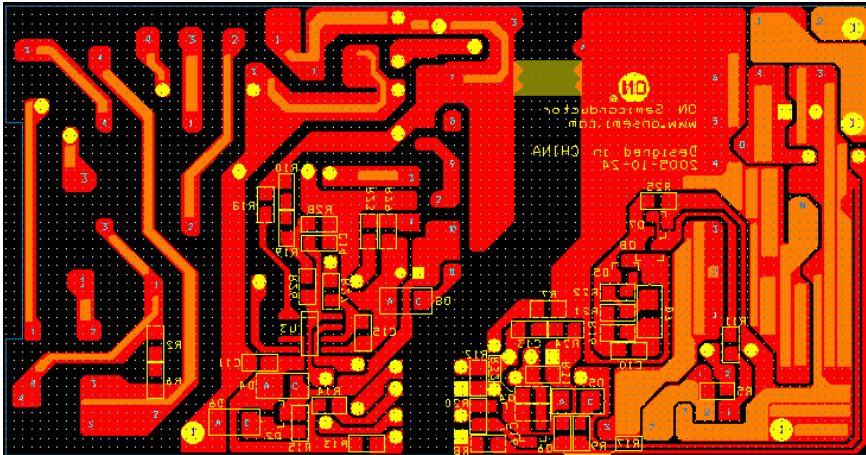

Bottom layer

11 BOM

Item	Quantity	Reference	Part	Manufacturer
1	1	C1	2.2 nF/Y1	
2	2	C2, C3	2200 uF, 16 V	
3	1	C4	470 uF, 16 V	
4	1	C5	4.7 nF, 1 kV	
5	1	C6	0.22 uF/X2	
6	1	C7	150 uF, 400 V	
7	1	C8	10 nF, 1 kV	
8	1	C9	2.2 nF, 100 V	
9	1	C10	1 nF, 50 V	
10	4	C11, C13, C14, C16	0.1 uF, 50 V	
11	1	C12	47 uF, 25 V	
12	1	C15	100 pF, 50 V	
13	1	D1	GBU608	
14	1	D2	MBR160	ON Semiconductor
15	1	D3	1N4937	ON Semiconductor
16	3	D4, D7, D8	MMSD4148	ON Semiconductor
17	1	D5	MMSZ13	ON Semiconductor
18	1	D6	MMSZ15	ON Semiconductor
19	1	F1	T3A250VAC	
20	1	L1	1.8 uH, 5 A	
21	1	L2	75 uH	
22	1	L3	150 uH	
23	1	L4	20 mH	
24	1	Q1	NTP75N06	ON Semiconductor
25	4	Q2, Q5, Q6, Q8	MMBT3904L	ON Semiconductor
26	1	Q3	9 A, 650 V	
27	2	Q4, Q7	MMBT3906L	ON Semiconductor
28	1	R1	5 ohm NTC	
29	4	R2, R6, R10, R19	1M	
30	1	R3	MOV471	
31	1	R4	47 k/1 W	
32	1	R5	4.7 ohm	
33	3	R7, R15, R18	2k	
34	4	R8, R22, R26, R31	5.1k	
35	4	R9, R20, R29, R32	10k	
36	2	R23, R11	10 ohm	
37	5	R12, R14, R16, R24, R25	1k	
38	1	R13	15k	
39	1	R17	20k	
40	1	R21	27 ohm	
41	1	R27	2.4k	
42	1	R28	9.1k	
43	1	R30	0.18/1 W	
44	1	T1	PQ3220	
45	1	T2	CT1:100 Toroid or UU9.8	
46	2	U1, U2	PC817C	
47	1	U3	NCP1337	ON Semiconductor
48	1	U4	TL431A	ON Semiconductor
49	1	PCB	PCB5.2*10	

12 Appendix

12.1 Product Information

- [NCP1337](#) Quasi Resonant Controller featuring Over Power Compensation
- [TL431A](#) Programmable Precision Reference
- [1N4937](#) Fast-Recovery Rectifier, 1 A, 600 V
- [MBR160](#) Schottky Rectifier, 1 A, 60 V
- [MMBT3904L](#) General Purpose Transistor, NPN
- [MMBT3906L](#) General Purpose Transistor, PNP
- [MMSD4148](#) Switching Diode
- [MMSZ13](#) Zener Diode, 500 mW, 13 V
- [MMSZ15](#) Zener Diode, 500 mW, 15 V
- [NTP75N06](#) Power MOSFET, 75 A, 60 V

12.2 References

CECP (China):

- <http://www.cecp.org.cn/englishhtml/index.asp>

Energy Saving (Korea)

- <http://weng.kemco.or.kr/efficiency/english/main.html#>

Top Runner (Japan):

- http://www.eccj.or.jp/top_runner/index.html

EU Eco-label (Europe):

- http://europa.eu.int/comm/environment/ecolabel/index_en.htm
- http://europa.eu.int/comm/environment/ecolabel/product/pg_portablecomputers_en.htm

EU Code of Conduct (Europe):

- http://energyefficiency.jrc.cec.eu.int/html/standby_initiative.htm

GEEA (Europe):

- <http://www.efficient-appliances.org/>
- <http://www.efficient-appliances.org/Criteria.htm>

Energy Star:

- <http://www.energystar.gov/>
- http://www.energystar.gov/index.cfm?c=ext_power_supplies.power_supplies_consumers

1 Watt Executive Order:

- <http://oahu.lbl.gov/>
- http://oahu.lbl.gov/level_summary.html

12.3 Transformer Specification

$L_p(W1+W4)=600\mu H \pm 7\% @ 10\text{KHz } 1\text{V}$

Leaking induction: 60uH max

CORE: PQ32-20

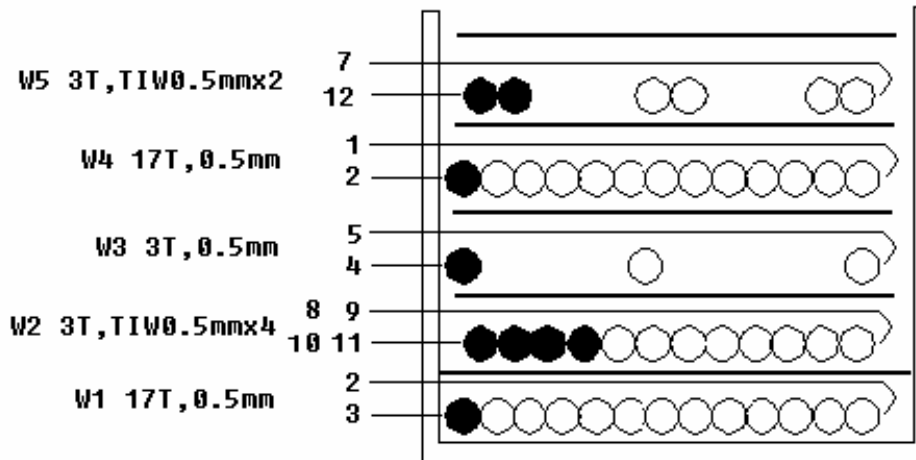
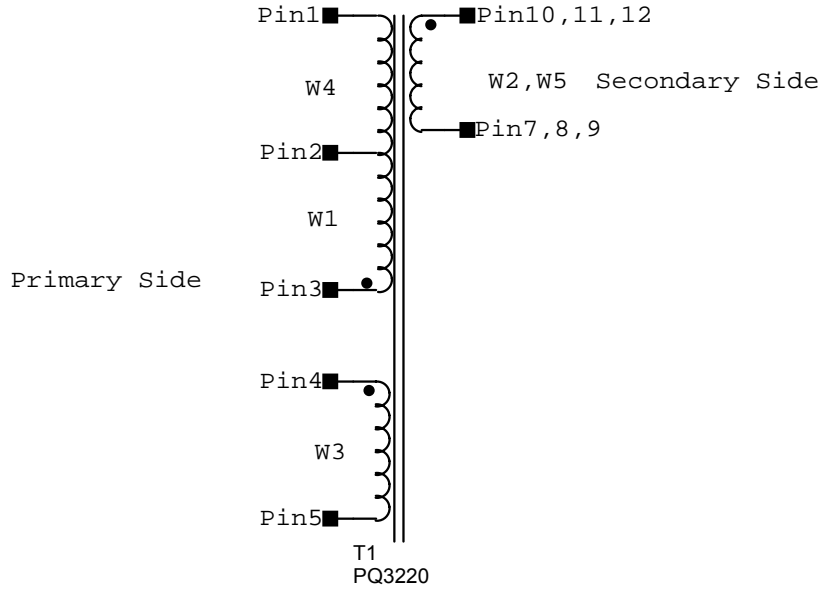

ON Semiconductor and  are registered trademarks of Semiconductor Components Industries, LLC (SCILLC). SCILLC reserves the right to make changes without further notice to any products herein. SCILLC makes no warranty, representation or guarantee regarding the suitability of its products for any particular purpose, nor does SCILLC assume any liability arising out of the application or use of any product or circuit, and specifically disclaims any and all liability, including without limitation special, consequential or incidental damages. "Typical" parameters which may be provided in SCILLC data sheets and/or specifications can and do vary in different applications and actual performance may vary over time. All operating parameters, including "Typicals" must be validated for each customer application by customer's technical experts. SCILLC does not convey any license under its patent rights nor the rights of others. SCILLC products are not designed, intended, or authorized for use as components in systems intended for surgical implant into the body, or other applications intended to support or sustain life, or for any other application in which the failure of the SCILLC product could create a situation where personal injury or death may occur. Should Buyer purchase or use SCILLC products for any such unintended or unauthorized application, Buyer shall indemnify and hold SCILLC and its officers, employees, subsidiaries, affiliates, and distributors harmless against all claims, costs, damages, and expenses, and reasonable attorney fees arising out of, directly or indirectly, any claim of personal injury or death associated with such unintended or unauthorized use, even if such claim alleges that SCILLC was negligent regarding the design or manufacture of the part. SCILLC is an Equal Opportunity/Affirmative Action Employer. This literature is subject to all applicable copyright laws and is not for resale in any manner.

PUBLICATION ORDERING INFORMATION

LITERATURE FULFILLMENT:

Literature Distribution Center for ON Semiconductor
P.O. Box 61312, Phoenix, Arizona 85082-1312 USA

Phone: 480-829-7710 or 800-344-3860 Toll Free USA/Canada

Fax: 480-829-7709 or 800-344-3867 Toll Free USA/Canada

Email: orderlit@onsemi.com

N. American Technical Support: 800-282-9855 Toll Free
USA/Canada

Japan: ON Semiconductor, Japan Customer Focus Center
2-9-1 Kamimeguro, Meguro-ku, Tokyo, Japan 153-0051
Phone: 81-3-5773-3850

ON Semiconductor Website: <http://onsemi.com>

Order Literature: <http://www.onsemi.com/litorder>

For additional information, please contact your
local Sales Representative.