



Table of Contents

1 Specifications Of The Board.....	2
2 Example Circuit.....	2
3 Powering The Converter.....	2
4 Enabling The Converter.....	2
5 Testing The Converter.....	3
6 SKIP/PWM.....	3
7 MOSFET Footprints.....	3
8 Permanent Components.....	3
9 Additional Footprints.....	4
10 Complete Circuit Schematic.....	5
11 Connection Diagrams.....	6
12 Typical Performance Waveforms.....	7
13 Bill of Materials (BOM).....	10
14 PCB Layout.....	11
15 Revision History.....	14

Trademarks

All trademarks are the property of their respective owners.

1 Specifications Of The Board

The evaluation board has been designed to test various circuits using the LM3495 buck regulator controller.

Figure 10-1 shows a complete schematic for all components. The board has four layers, consisting of signal/power traces on the top and bottom, one internal ground plane, and an internal split power plane. The top and bottom planes are 1-oz. copper, internal planes are 1/2 oz., and the board is 62-mil FR4 laminate.

2 Example Circuit

The example circuit that comes on the evaluation board steps input voltages of $12\text{ V} \pm 10\%$ down to 1.2 V at currents up to 10 A with a switching frequency of 500 kHz . The measured efficiency of the converter is 86% at an output current of 7 A .

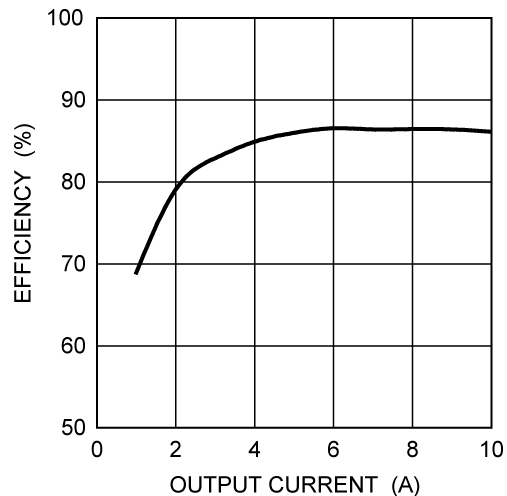

Figure 2-1. Efficiency for $V_{IN} = 12\text{ V}$

3 Powering The Converter

The example circuit for the LM3495 evaluation board is optimized to run at inputs of 12 V , however the circuit will operate with input voltages ranging from 2.9 V to 18.0 V connected between the 'VIN' and 'GND' terminals at the top of the board. Fixed loads, resistors, and variable electronic loads can be connected between the 'Vo' and 'GND' terminals. Table 13-1 lists all the components used in the example circuit.

4 Enabling The Converter

The SPDT switch ON/OFF controls the state of the converter while power is applied to the input terminals. While in the OFF position the COMP/SD* pin of the LM3495 is grounded, the output is disabled, and the IC enters a low power state. While in the ON position the output voltage is regulated and is capable of delivering current to a load connected at the output terminals.

5 Testing The Converter

Figure 11-1 shows a block diagram of connections for making measurements of efficiency. The wires used for making connections at both the input and output should be rated to at least 10 A of continuous current and should be no longer than is needed for convenient testing. A series ammeter capable of measuring 10 A or more should be used for both the input and the output lines. Dedicated voltmeters should be connected with their positive and negative leads right at the four power terminals at the top of the evaluation board. This measurement technique minimizes the voltage loss in the wires that connect the evaluation board to the input power supply and the electronic load.

Output voltage ripple measurements should be taken directly across the 100-nF ceramic capacitor, C_{ox} , placed right between the output terminals. Care must be taken to minimize the loop area between the oscilloscope probe tip and the ground lead. One method to minimize this loop is to remove the spring tip and ‘pigtail’ ground lead of the probe and then wind bare wire around the probe shaft. The bare wire should contact the ground of the probe and the end of the wire can then contact the ground side of C_{ox} . Figure 11-2 shows a diagram of this method.

An oscilloscope probe modified as described above can also be used to measure the switch node voltage, LG pin voltage, and HG pin voltage (all three with respect to ground) using the 40-mil diameter hole pairs labeled “+ SW –”, “+ LG –”, and “+ HG –”, respectively.

6 SKIP/PWM

A second SPDT switch labeled SKIP/FPWM determines that control scheme the LM3495 uses at low output currents. When set to SKIP, the converter saves energy during light loads (approximately 100 mA or less) by using the body diode of the low-side FET, as well as leaving the high-side FET off if possible. When the switch is set to FPWM, the LM3495 forces both top and bottom FETs to switch during every cycle, regardless of the load current.

7 MOSFET Footprints

The LM3495 evaluation board has footprints for single N-MOSFETs with SO-8 packages and standard pinouts. These footprints can also accept newer MOSFET packages that are compatible with SO-8 footprints. See Figure 7-1. Q1 is the high-side FET and Q2 low-side FET.

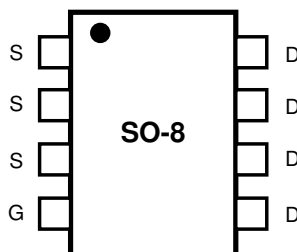

Figure 7-1. SO-8 MOSFET Pinout

8 Permanent Components

The following components should remain the same for any new circuits evaluated on the LM3495 evaluation board:

Name	Value
C_b	0.1 μF
C_f	1 μF
C_{dd}	2.2 μF

9 Additional Footprints

A 100-pF ceramic capacitor should be placed at position *Dsync* whenever the LM3495 runs without an external clock. When an external clock is used, *Dsync* should be removed and a 100-pF ceramic capacitor placed at *Csync*.

The 0-Ω resistor *J1* connects the TRACK pin and VDD pins of the LM3495 together. It should be removed only when the tracking function is used.

The 0-Ω resistor *J2* connects the VIN and VLIN5 terminals of the LM3495 together. This resistor should be used only when the input voltage is 5.5 V or less to provide maximum MOSFET gate drive.

The 0-Ω resistor *J3* connects the 'VIN' terminal to the VIN pin of the LM3495. This resistor should be removed only for testing of the input current draw of the LM3495 IC.

The 0-Ω resistor *Rbst* can be replaced with a higher value resistor to limit the current drawn by the BOOST pin. This slows the high-side FET gate drive rise time and can reduce ringing on the switch node. Care must be taken, as slowing the gate drive too much can cause shoot-through current.

Components *Rt1* and *Rt2* are used if the output of the converter is tracking another supply during start-up. For this application, the output of the external supply should be connected to the TRACK IN terminal. When the tracking feature is not used, the track pin should be connected to the VDD pin by placing a 0-Ω resistor in position *J2*.

Components *Rsnb* and *Csnb* can be used to filter ringing on the switch node.

D2 provides a position for a diode to go in parallel with Q2. In circuits with output currents of approximately 5 A or less, a Schottky diode at *D2* can improve the efficiency of the converter.

10 Complete Circuit Schematic

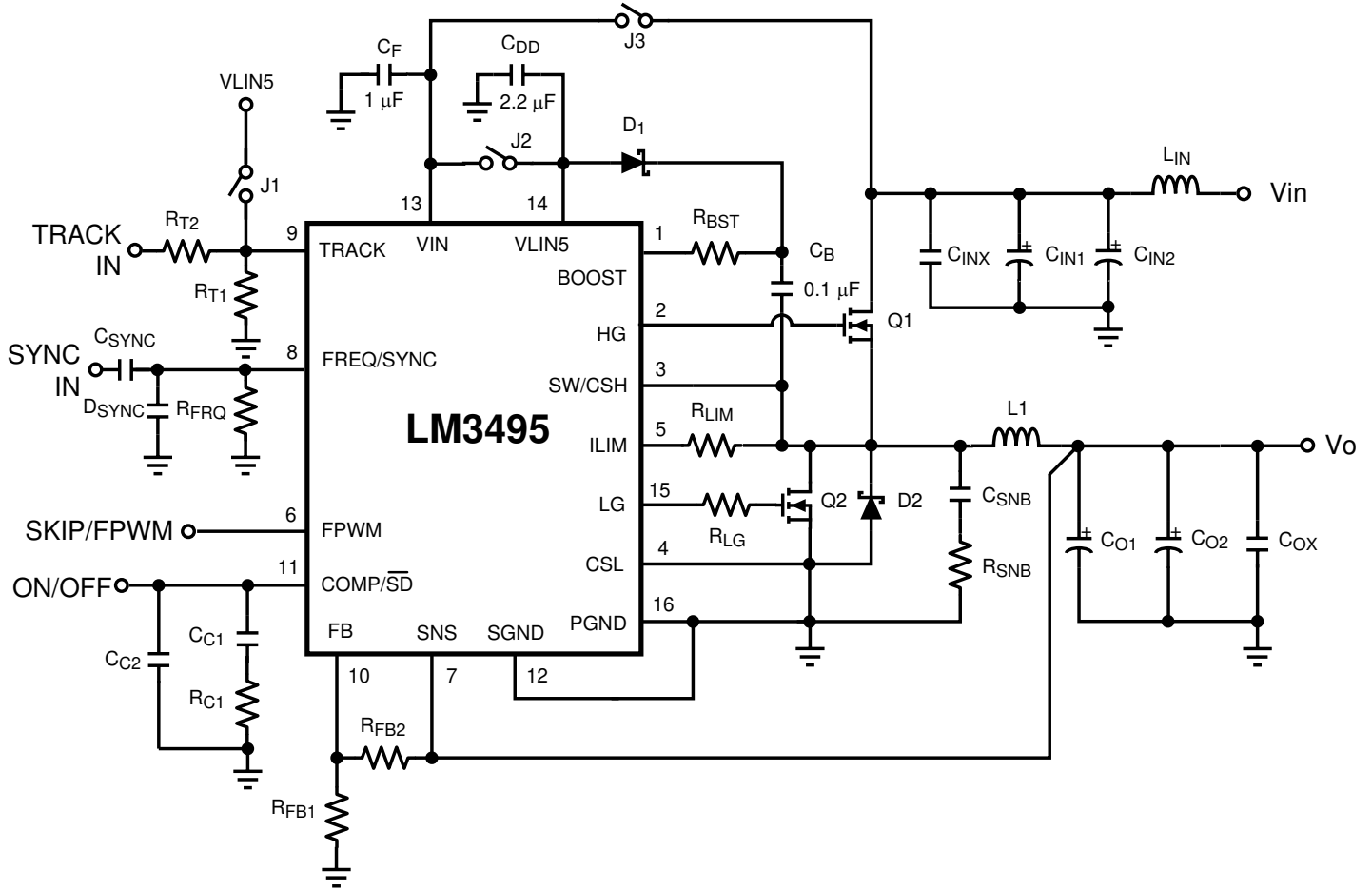

Figure 10-1. Circuit Schematic

11 Connection Diagrams

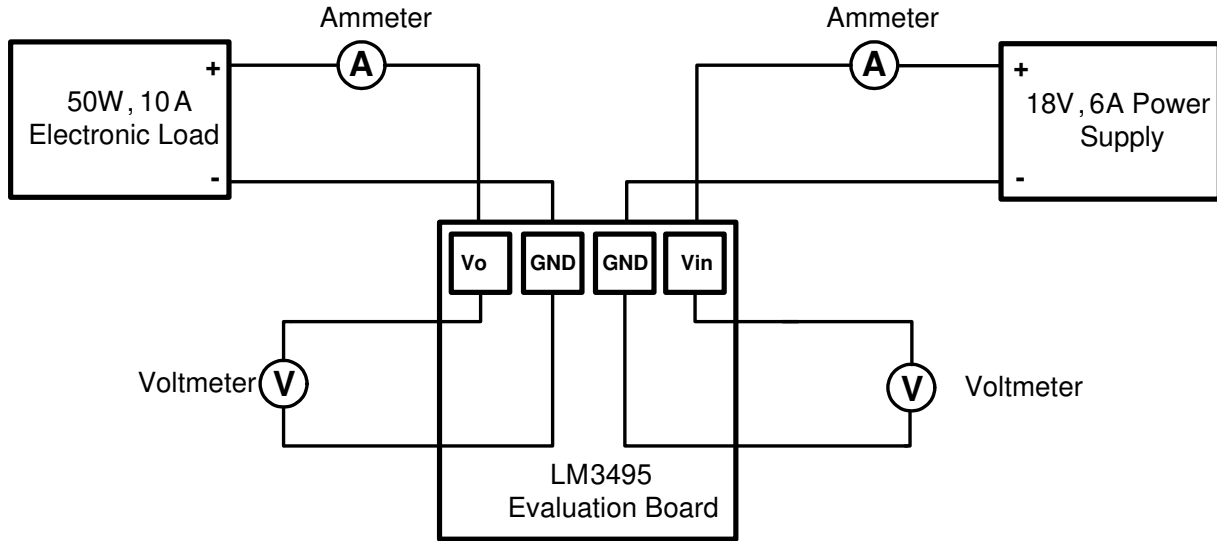

Figure 11-1. Efficiency Measurement Setup

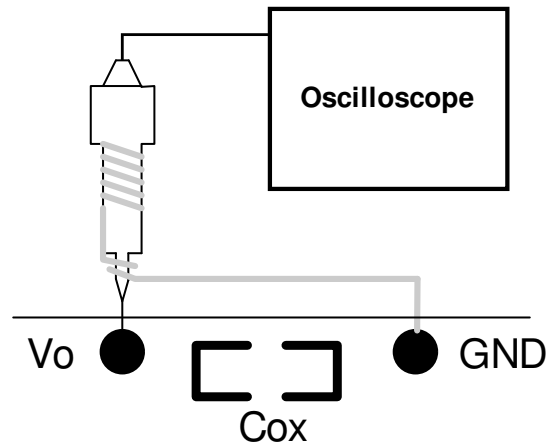

Figure 11-2. Output Voltage Ripple Measurement Setup

12 Typical Performance Waveforms

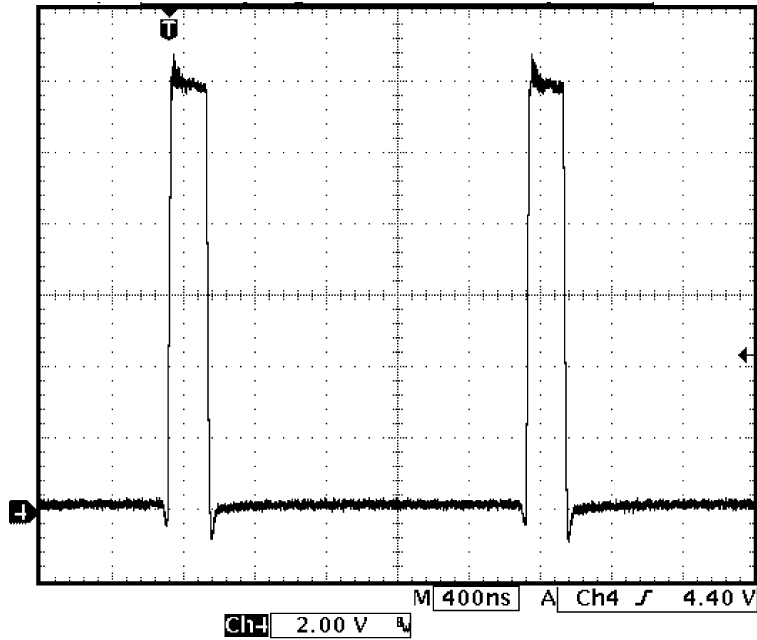

Figure 12-1. Switch Node Voltage ($V_{IN} = 12\text{ V}$, $V_O = 1.2\text{ V}$, $I_O = 5\text{ A}$)

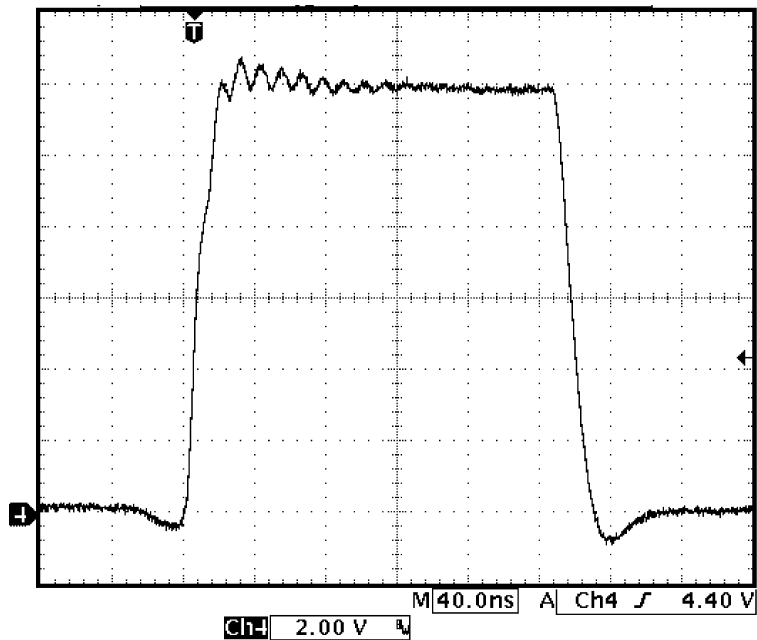

Figure 12-2. Switch Node Voltage ($V_{IN} = 12\text{ V}$, $V_O = 1.2\text{ V}$, $I_O = 5\text{ A}$)

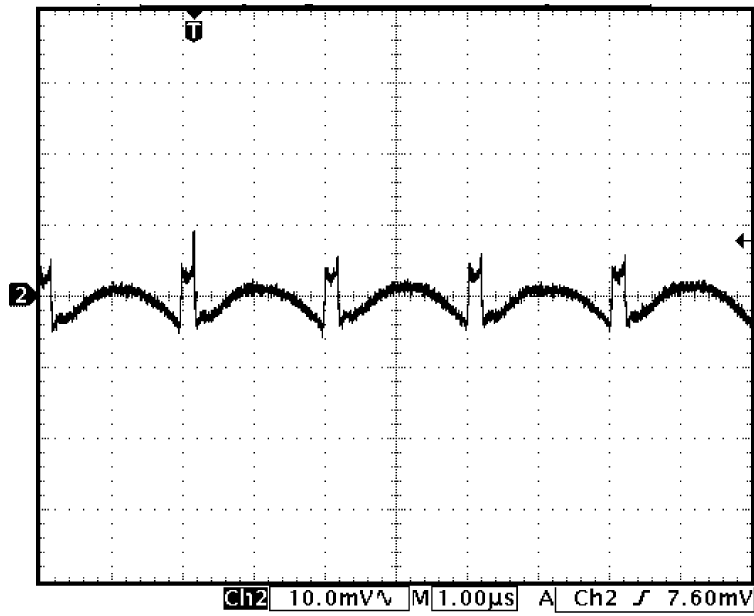

Figure 12-3. Output Voltage Ripple, AC Coupled ($V_{IN} = 12\text{ V}$, $V_O = 1.2\text{ V}$, $I_O = 5\text{ A}$)

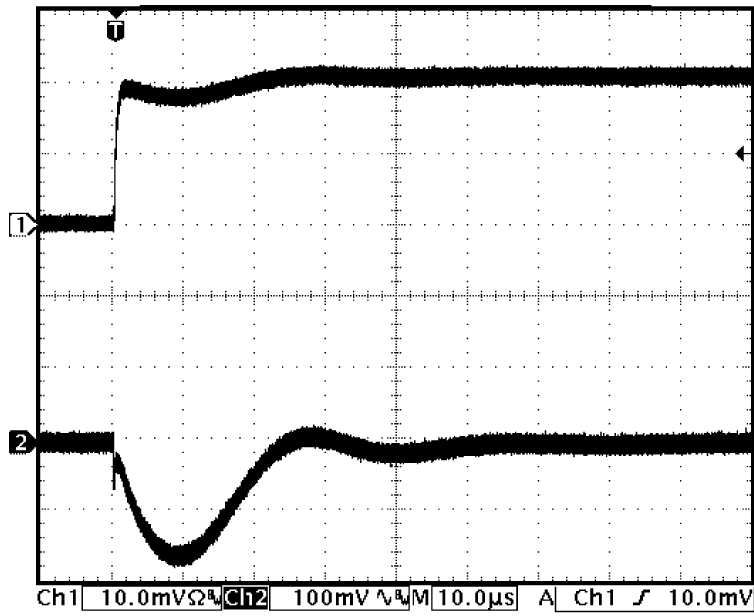

Figure 12-4. Load Transient Response ($V_{IN} = 12\text{ V}$, $V_O = 1.2\text{ V}$, $I_O = 0\text{ A}$ to 4 A)

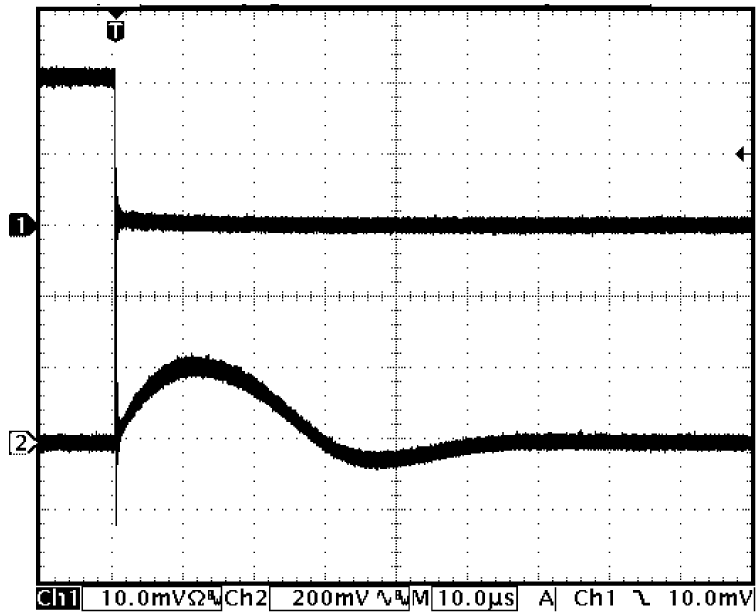

Figure 12-5. Load Transient Response ($V_{IN} = 12\text{ V}$, $V_O = 1.2\text{ V}$, $I_O = 4\text{ A}$ to 0 A)

13 Bill of Materials (BOM)

Table 13-1. Bill of Materials (BOM)

Qty	ID	Part Number	Type	Size	Parameters	Vendor
1	U1	LM3495	Synchronous Controller	TSSOP-16		TI
1	Q1	HAT2198R	N-MOSFET	SO-8	30 V, 9.6 mΩ 11 nC	Renesas
1	Q2	HAT2165H	N-MOSFET	LFAK	30 V 3.4 mΩ, 33 nC	Renesas
1	D1	MBR0530	Schottky Diode	SMA	30 V, 0.5 A	Vishay
1	L1	RLF12560T-1R0N140	Inductor	12.5x12.8 x6.0mm	1 μH, 14 A, 3 mΩ	TDK
1	Cin	C3225X5R1E226M	Capacitor	1210	22 μF, 25 V	TDK
2	Co1, Co2	C3225X5R0J107M	Capacitor	1210	100 μF, 6.3 V, 1 mΩ	TDK
1	Cf	C3216X7R1E105M	Capacitor	1206	1 μF, 25 V	TDK
1	Cdd	C3216X7R1E225M	Capacitor	1206	2.2 μF, 25 V	TDK
2	Cb, Cinx	VJ1206Y104KXXAT	Capacitor	1206	100 nF, 10%	Vishay
1	Cc1	VJ1206Y103KXXAT	Capacitor	1206	10 nF, 10%	Vishay
3	Cc2, Csync, Dsync	VJ1206A101KXXAT	Capacitor	1206	100 pF, 10%	Vishay
1	Cox	VJ0805Y104KXXAT	Capacitor	805	100 nF, 10%	Vishay
3	Rbst, J1, J3	CRCW08050R00F	Resistor	805	0 Ω	Vishay
1	Lin	CRCW25120R00F	Resistor	2512	0 Ω	Vishay
1	Rc1	CRCW12061501F	Resistor	1206	1.5 kΩ, 1%	Vishay
2	Rfb1, Rfb2	CRCW12061002F	Resistor	1206	10 kΩ, 1%	Vishay
1	Rfrq	CRCW12065492F	Resistor	1206	54.9 kΩ, 1%	Vishay
1	Rlg	CRCW12061R00F	Resistor	1206	1 Ω, 1%	Vishay
1	Rlim	CRCW12063321F	Resistor	1206	3.32 kΩ, 1%	Vishay
2	SKIP/FPWM ON/OFF	NKK A12AB	SPST			NKK
5	Vo, GND1 GND2, GND3 Vin	Newark 40F6004	Terminal Silver	0.094"		Cambion
4	SYNC IN GND4, GND5 TRACK IN	Newark 94F1478	Terminal Silver	0.062"		Keystone

14 PCB Layout

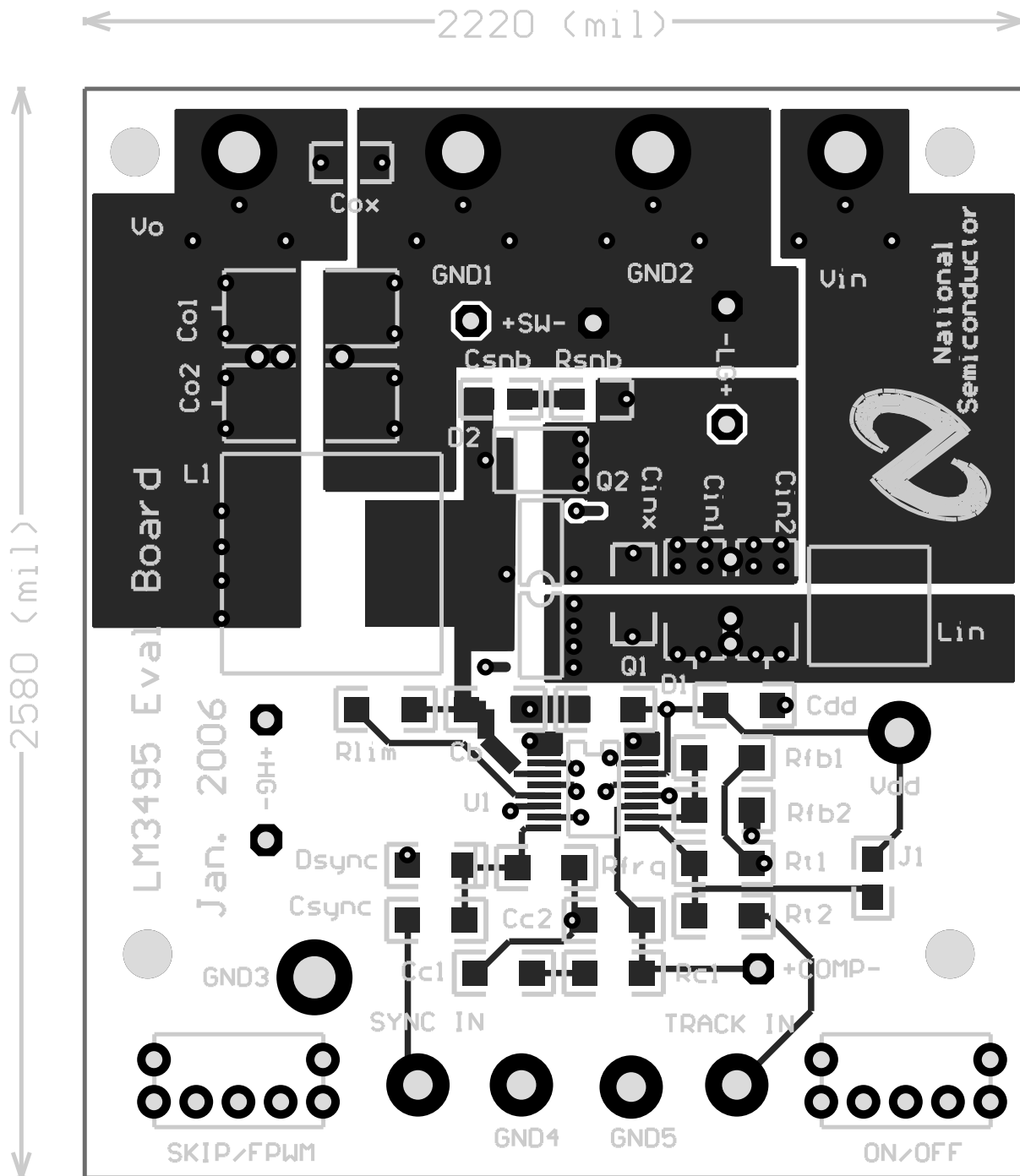

Figure 14-1. Top Layer and Top Overlay

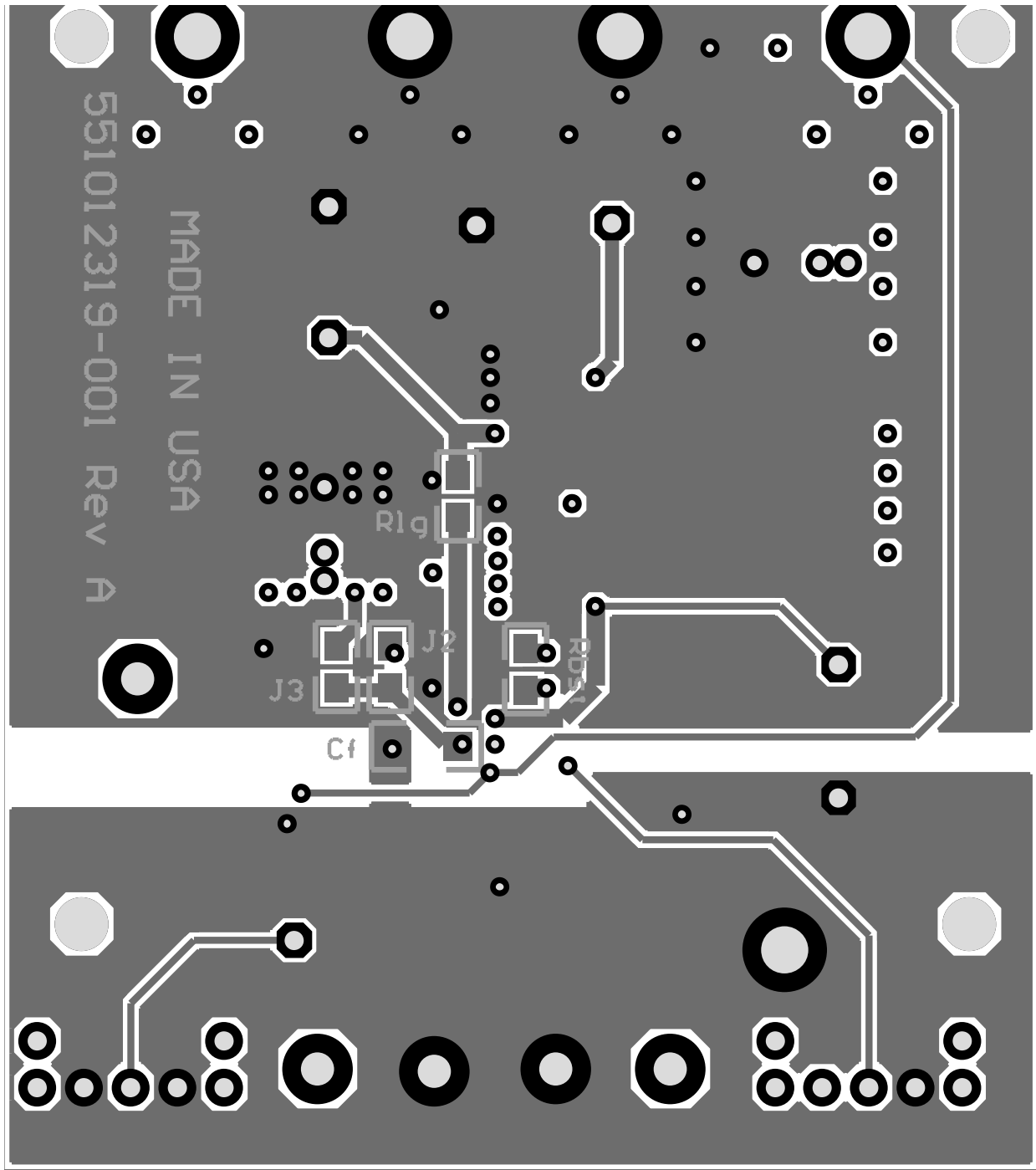

Figure 14-2. Bottom Layer

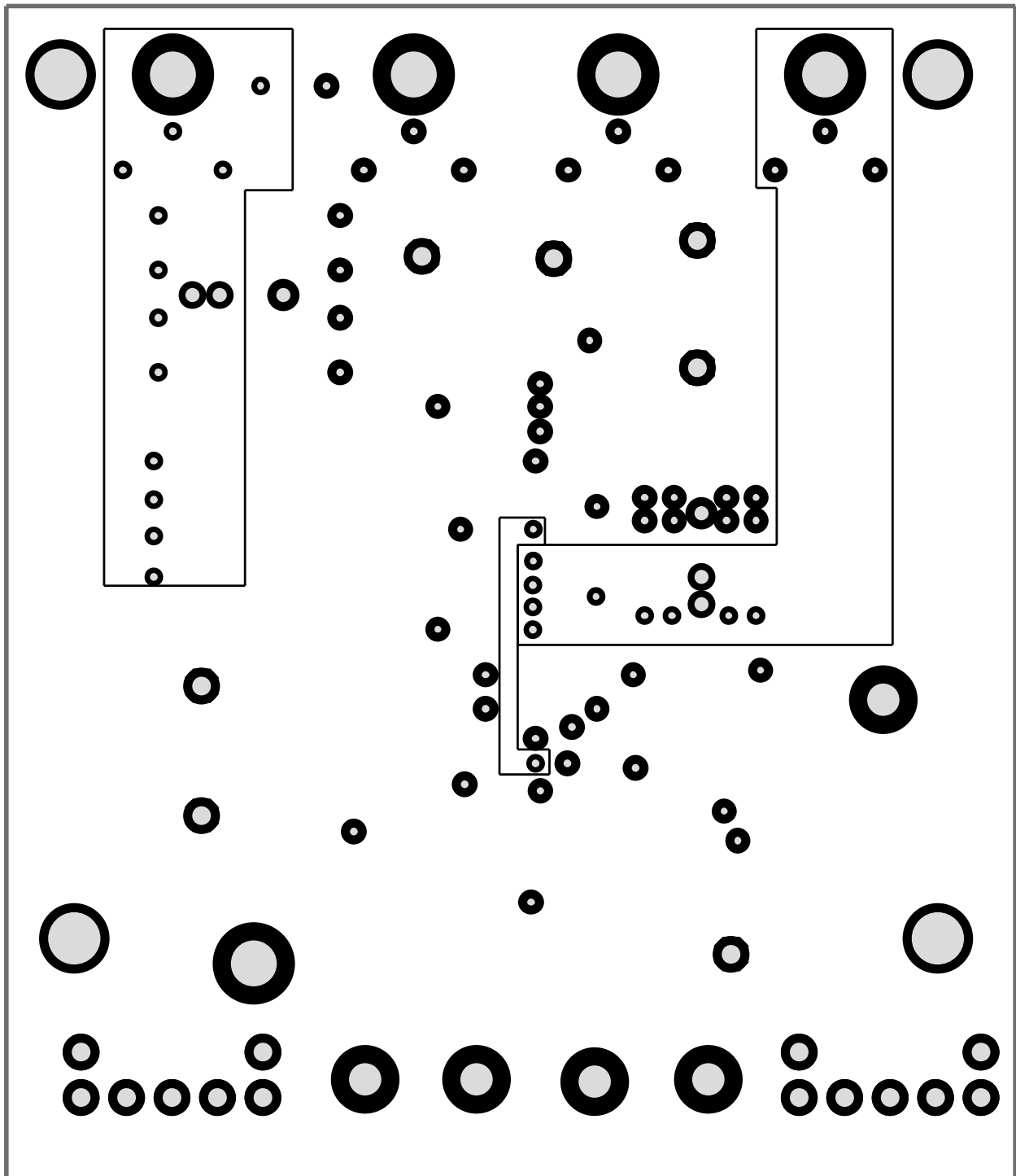

Figure 14-3. Internal Layer 1

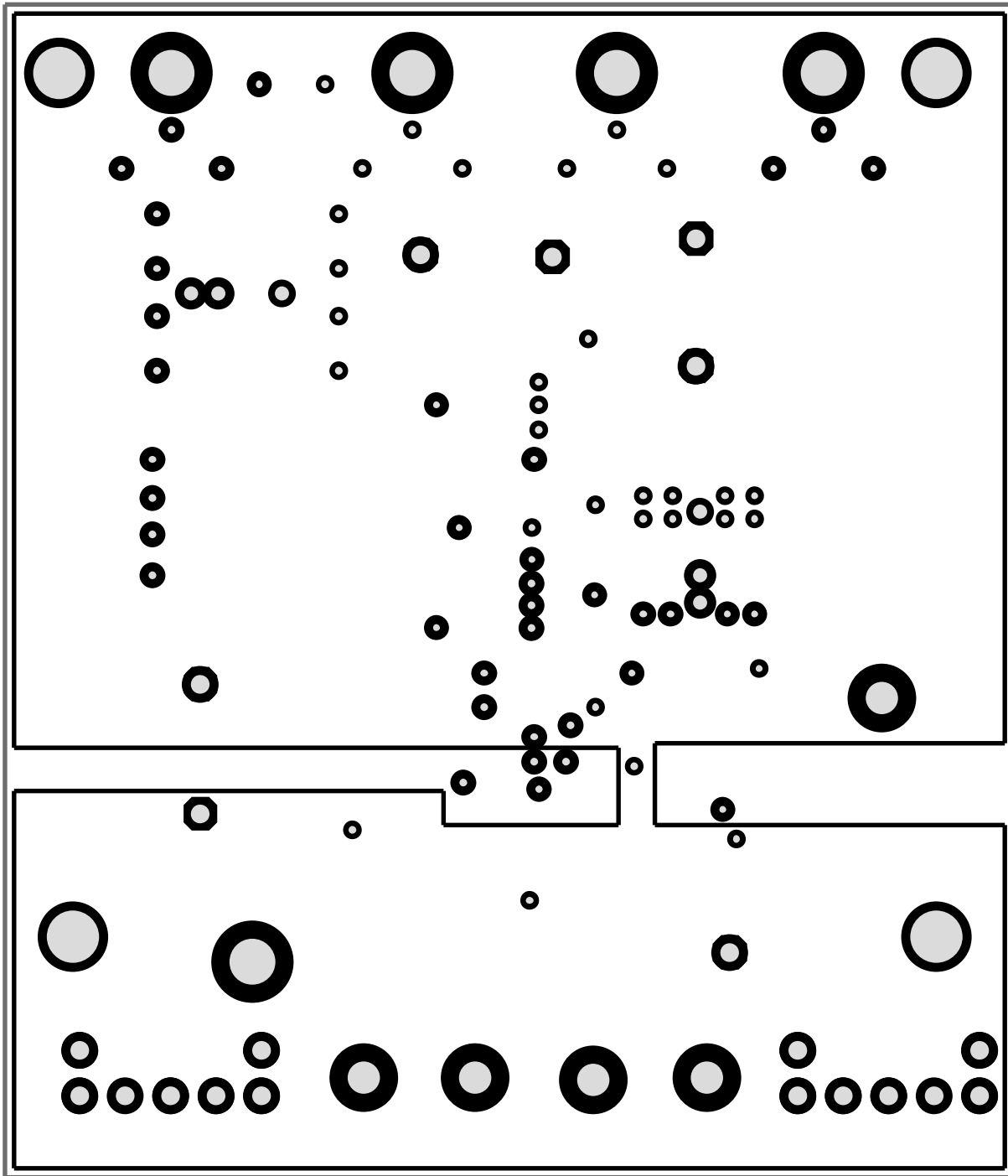

Figure 14-4. Internal Layer 2

15 Revision History

NOTE: Page numbers for previous revisions may differ from page numbers in the current version.

Changes from Revision B (April 2013) to Revision C (February 2022)

Page

- Updated the numbering format for tables, figures, and cross-references throughout the document.2
- Updated the user's guide title..... 2

IMPORTANT NOTICE AND DISCLAIMER

TI PROVIDES TECHNICAL AND RELIABILITY DATA (INCLUDING DATA SHEETS), DESIGN RESOURCES (INCLUDING REFERENCE DESIGNS), APPLICATION OR OTHER DESIGN ADVICE, WEB TOOLS, SAFETY INFORMATION, AND OTHER RESOURCES "AS IS" AND WITH ALL FAULTS, AND DISCLAIMS ALL WARRANTIES, EXPRESS AND IMPLIED, INCLUDING WITHOUT LIMITATION ANY IMPLIED WARRANTIES OF MERCHANTABILITY, FITNESS FOR A PARTICULAR PURPOSE OR NON-INFRINGEMENT OF THIRD PARTY INTELLECTUAL PROPERTY RIGHTS.

These resources are intended for skilled developers designing with TI products. You are solely responsible for (1) selecting the appropriate TI products for your application, (2) designing, validating and testing your application, and (3) ensuring your application meets applicable standards, and any other safety, security, regulatory or other requirements.

These resources are subject to change without notice. TI grants you permission to use these resources only for development of an application that uses the TI products described in the resource. Other reproduction and display of these resources is prohibited. No license is granted to any other TI intellectual property right or to any third party intellectual property right. TI disclaims responsibility for, and you will fully indemnify TI and its representatives against, any claims, damages, costs, losses, and liabilities arising out of your use of these resources.

TI's products are provided subject to [TI's Terms of Sale](#) or other applicable terms available either on ti.com or provided in conjunction with such TI products. TI's provision of these resources does not expand or otherwise alter TI's applicable warranties or warranty disclaimers for TI products.

TI objects to and rejects any additional or different terms you may have proposed.

Mailing Address: Texas Instruments, Post Office Box 655303, Dallas, Texas 75265
Copyright © 2022, Texas Instruments Incorporated