

## AN-1640 LM2743-19A Demo Board

### 1 Introduction

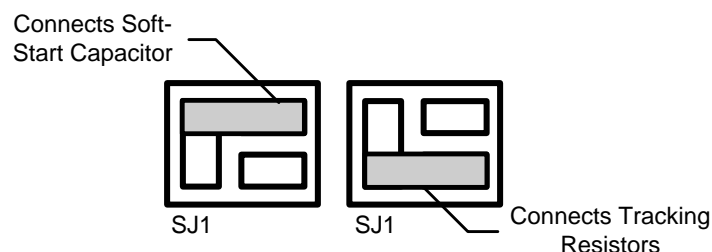
This user's guide describes the LM2743 printed circuit board (PCB) design and provides an example typical application circuit. The LM2743 is a voltage mode PWM buck controller which implements synchronous rectification. It provides a low cost, high power density, and efficient point of load solution. In steady state operation the LM2743 is always synchronous, even at no load, thus simplifying the compensation design. The current limit protection does not require a current limit resistor in the power path, but is achieved by sensing the voltage  $V_{DS}$  across the low side MOSFET. Though the control sections of the IC are rated for 3 to 6V ( $V_{CC}$ ), the driver sections are designed to accept input supply rails ( $V_{IN}$ ) as high as 16V.

### 2 Specifics of the Board

This demo board targets the fixed and mobile telecommunications, industrial electronics, and distributed power markets. The demo board has a  $V_{IN}$  range of 8V to 14V and a LDO regulator, the LP2937, powers  $V_{CC}$  by regulating a 5V output voltage. The LM2743 regulates to an output range of 1.2V to 3.3V at 19A with a switching frequency of 300 kHz. Note, the demo board is optimized for the above parameters, thus for additional design modifications refer to the Design Consideration section of the LM2743 data sheet. The PCB is designed on four layers, the top and bottom layers are 2oz. copper and the two inner layers are 1oz. copper. The board measures 2.19 in. x 1.03 in. x 0.41 in. (56 mm x 26.2 mm x 10.3 mm) (l, w, h) on a FR4 laminate.

### 3 Feature Options

When the tracking feature of the LM2743 is required for use, remove the jumper that connects the soft-start capacitor C10 and connect the resistor divider, on designators R13 and R14, see [Figure 1](#). The Track terminal has been provided for your connecting convenience. The demo board switching frequency is user adjustable; note increasing the switching frequency results in a lower inductor current ripple and input and output voltage ripple (if the component values are the same). Monitor the MOSFET junction temperature since switching losses will increase, and do not exceed the maximum junction temperature of the MOSFET. Refer to the MOSFET manufacturer datasheet for maximum junction temperature specification and heat sinking guidelines.

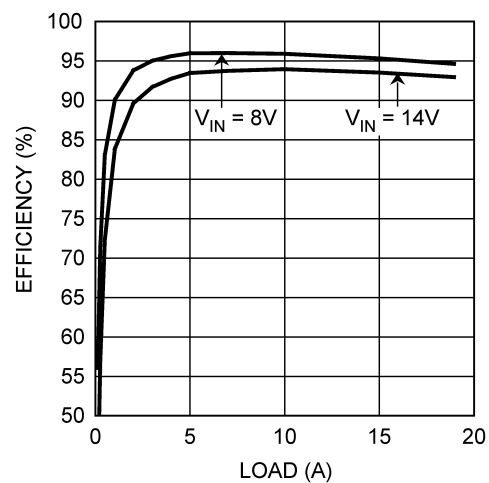


**Figure 1. Soft-Start and Tracking Jumper**

#### 4 Specification Summary

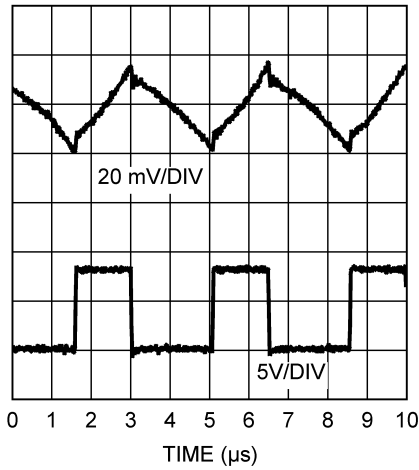
- Space saving footprint
- Wide ambient temperature range: -40 °C to 65 °C
- Input voltage range: 8V to 14V
- Adjustable output voltage: 1.2V to 3.3V
- No minimum load requirement
- Remote ON/OFF
- Power good signal
- Fixed switching frequency: 300 kHz
- Current Limit Protection
- Master power supply start-up tracking function
- Adjustable soft-start
- Small size 2.19 in. x 1.03 in. x 0.41 in. (56 mm x 26.2 mm x 10.3 mm)

#### 5 Performance Characteristics Efficiency

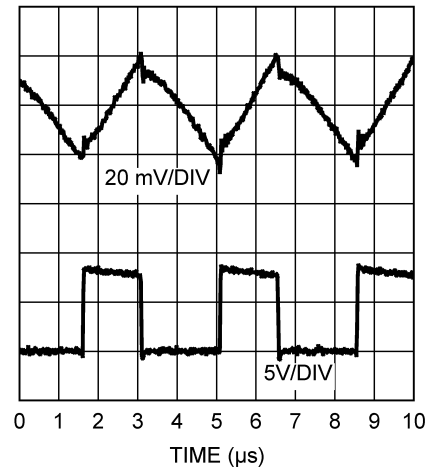


**Figure 2. Efficiency vs. Load Current**  
 $V_{OUT} = 3.3V$ ,  $f_{sw} = 300\text{ kHz}$

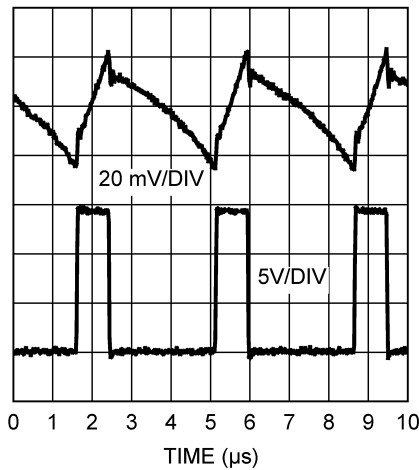
## 6 Switch Node Voltage and Output Voltage Ripple



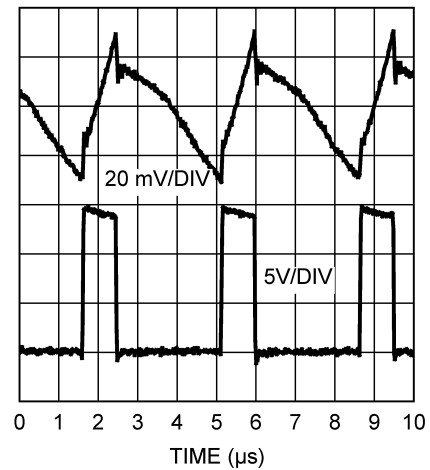
**Figure 3.**  $V_{IN} = 8V$ ,  $V_{OUT} = 3.3V$ ,  
 $I_{LOAD} = 100\text{ mA}$ ,  $f_{SW} = 300\text{ kHz}$   
20 MHz Bandwidth Limit



**Figure 4.**  $V_{IN} = 8V$ ,  $V_{OUT} = 3.3V$ ,  
 $I_{LOAD} = 19A$ ,  $f_{SW} = 300\text{ kHz}$   
20 MHz Bandwidth Limit



**Figure 5.**  $V_{IN} = 14V$ ,  $V_{OUT} = 3.3V$ ,  
 $I_{LOAD} = 100\text{ mA}$ ,  $f_{SW} = 300\text{ kHz}$   
20 MHz Bandwidth Limit



**Figure 6.**  $V_{IN} = 14V$ ,  $V_{OUT} = 3.3V$ ,  
 $I_{LOAD} = 19A$ ,  $f_{SW} = 300\text{ kHz}$   
20 MHz Bandwidth Limit

## 7 Load Transient Response

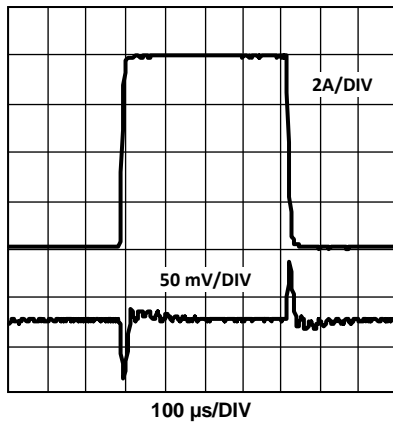


Figure 7.  $V_{IN} = 14V$ ,  $V_{OUT} = 3.3V$   
 $I_{LOAD} = 2A$  to  $10A$   
 CH1:  $V_{OUT}$ , CH2:  $I_{LOAD}$

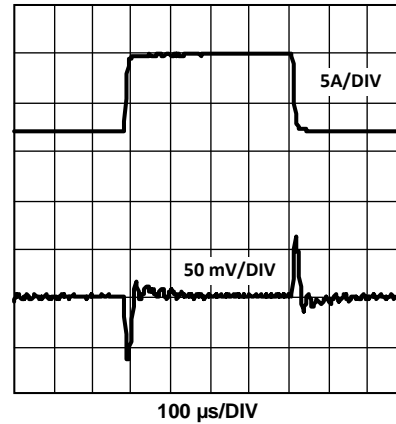


Figure 8.  $V_{IN} = 14V$ ,  $V_{OUT} = 3.3V$   
 $I_{LOAD} = 11A$  to  $19A$   
 CH1:  $V_{OUT}$ , CH2:  $I_{LOAD}$

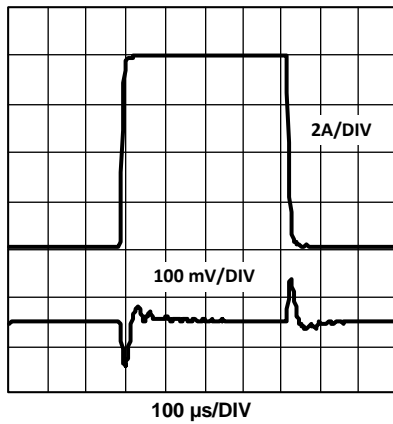


Figure 9.  $V_{IN} = 8V$ ,  $V_{OUT} = 3.3V$   
 $I_{LOAD} = 2A$  to  $10A$   
 CH1:  $V_{OUT}$ , CH2:  $I_{LOAD}$

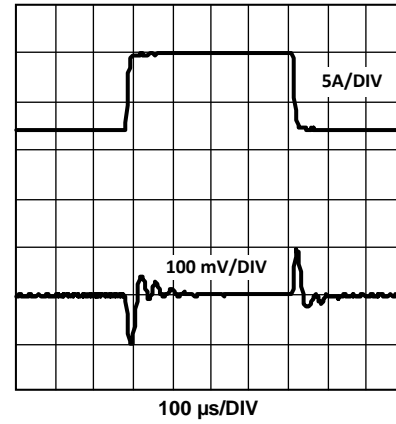


Figure 10.  $V_{IN} = 8V$ ,  $V_{OUT} = 3.3V$   
 $I_{LOAD} = 11A$  to  $19A$   
 CH1:  $V_{OUT}$ , CH2:  $I_{LOAD}$

## 8 Bill of Materials

**Table 1. Bill of Materials for LM2743 POL EVB (Vin: 8V to 14V, Vout: 3.3V, 19A)**

Location	Part Number	Type	Size	Parameters	Qty	Vendor
U1	LM2743	Syn. Buck Controller	TSSOP-14	Vin: 4.5V - 5.5V	1	Texas Instruments
U2	LM27937IMP-5.0	Linear Regulator 5V, 500mA	SOT-223	5V, 500mA	1	Texas Instruments
L1	SER2010-202ML	Inductor		2uH, 27A, 0.852mohm	1	Coilcraft
Q1-2	IRF6633	N-MOSFET	DirectFET-MP	20V, 16A, 4.1mohm, 11nC	2	Vishay
Q3	IRF6609	N-MOSFET	DirectFET-MT	20V, 150A, 2mohm, 46nC	1	Vishay
D1	SL22-E3/2C	Schottky Diode	SMB	20V, 2A	1	Vishay
D2	MBRS0520	Schottky Diode	SOD123	20V, 0.5A	1	Vishay
C1, 2	GRM32ER61C226KE20L	Ceramic Capacitor	1210	22µF, 25V, X7R, 5%	2	Murata
C3, 11	GRM319R71H104KA01B	Ceramic Capacitor	1206	100nF, 25V, X7R, 10%	2	Murata
C14	GRM319R71H474KA01B	Ceramic Capacitor	1206	470nF, 25V, X7R, 10%	1	Murata
C9	GRM1885C1H1210JA01	Ceramic Capacitor	0603	120pF, 50V, C0G, 5%	1	Murata
C6	GRM188R71H222KA01	Ceramic Capacitor	0603	2.2nF, 50V, X7R, 10%	1	Murata
C8	GRM188R71H332KA01	Ceramic Capacitor	0603	3.3nF, 50V, X7R, 10%	1	Murata
C10	GRM188R71H153KA01	Ceramic Capacitor	0603	15nF, 50V, X7R, 10%	1	Murata
C12	GRM40X7R472K25	Ceramic Capacitor	0805	470nF, 25V, X7R, 10%	1	Murata
C13	12066D226MAT	Ceramic Capacitor	1206	22µF, 6.3V, X5R, 20%	1	AVX
C4, 5	6SVPC220M	OS-CON	C6	220µF, 6.3V, 20%	2	Sanyo
R1,18	CRCW06030R00F	Chip Resistor	0603	0ohm	2	Vishay
R2	CRCW06032151F	Chip Resistor	0603	2.15k, 1%	1	Vishay
R3, R17	CRCW06031002F	Chip Resistor	0603	10k, 1%	2	Vishay
R4	CRCW06032211F	Chip Resistor	0603	2.21k, 1%	1	Vishay
R10, 11	CRCW06031003F	Chip Resistor	0603	100k, 1%	2	Vishay
R5, 6, 8	CRCW06032R21F	Chip Resistor	0603	2.21ohm, 1%	3	Vishay
R7, 9	CRCW06034702F	Chip Resistor	0603	47k, 1%	2	Vishay
R12	CRCW06038451F	Chip Resistor	0603	8.45k, 1%	1	Vishay
R15	CRCW06031821F	Chip Resistor	0603	1.82k, 1%	1	Vishay
R16	CRCW060310R0F	Chip Resistor	0603	10ohm, 1%	1	Vishay
-	-	F-Pin			8	
-	-	Pin 90 deg., SIP, 6 way	Pitch: 2.54mm		1	

9 Demo Board Schematic

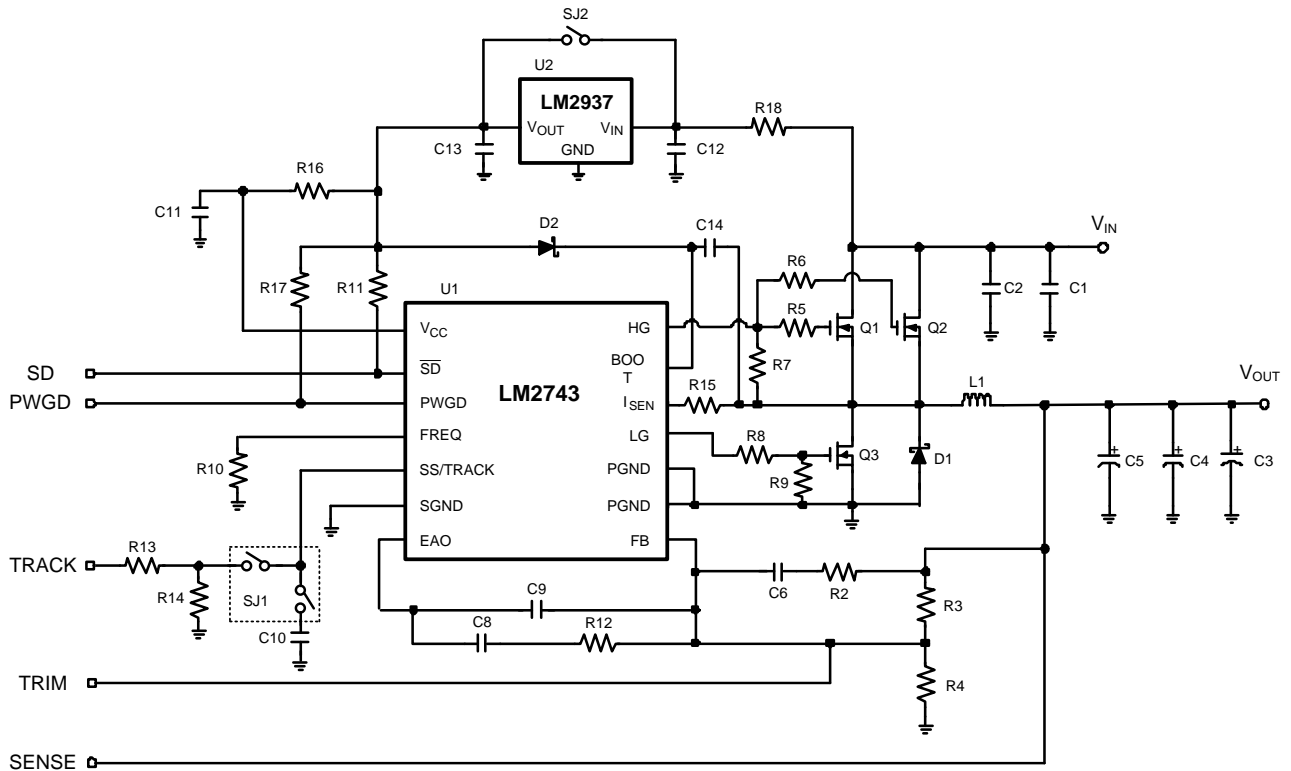


Figure 11. 300 kHz Demo Board Schematic

10 PCB Layout

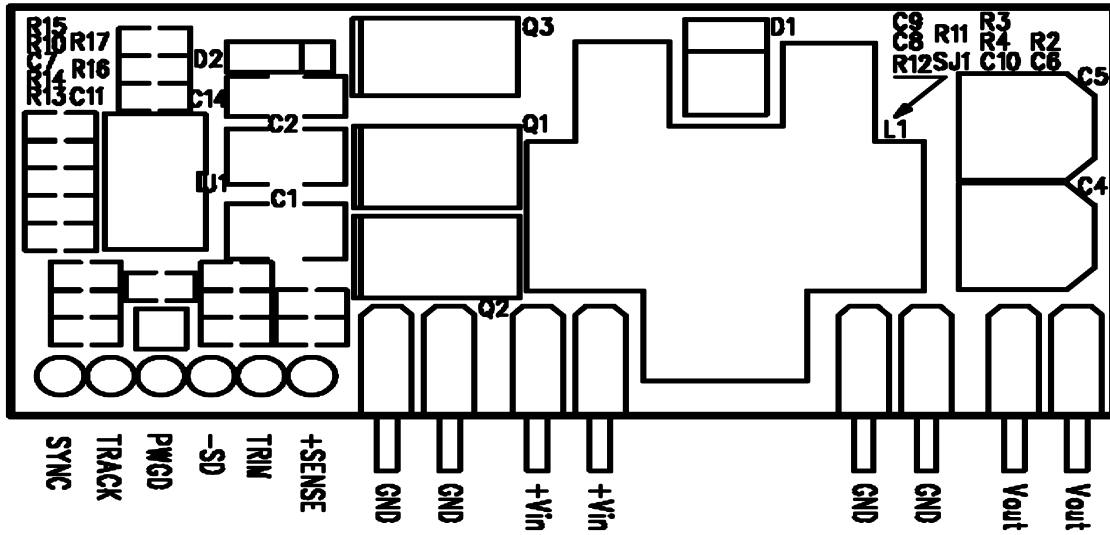


Figure 12. Top Silkscreen

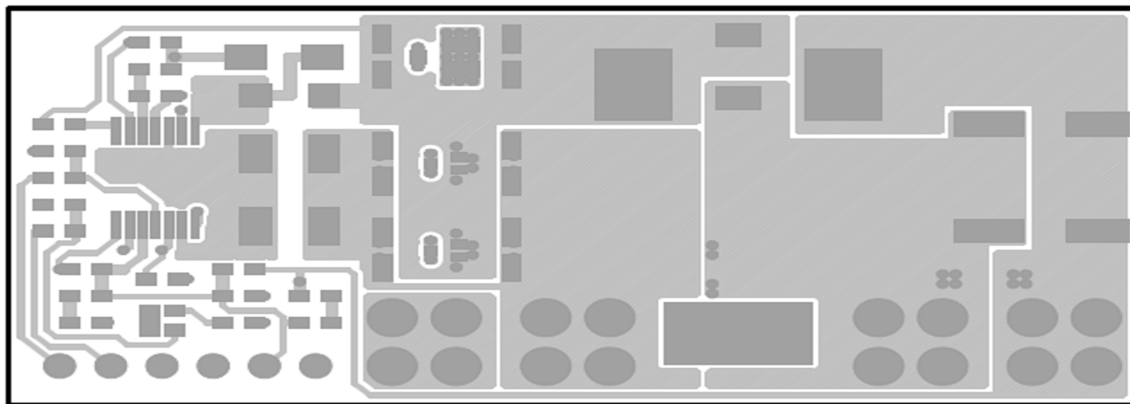


Figure 13. Top Copper Layer

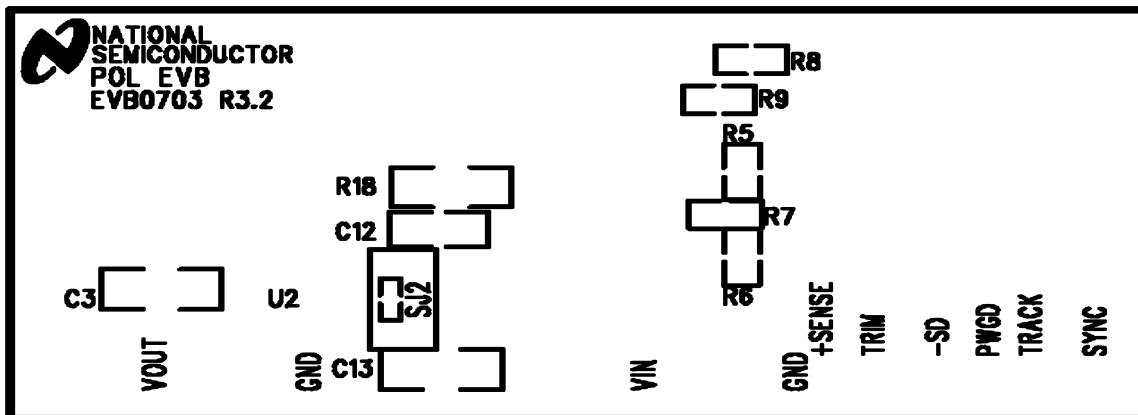


Figure 14. Bottom Silkscreen

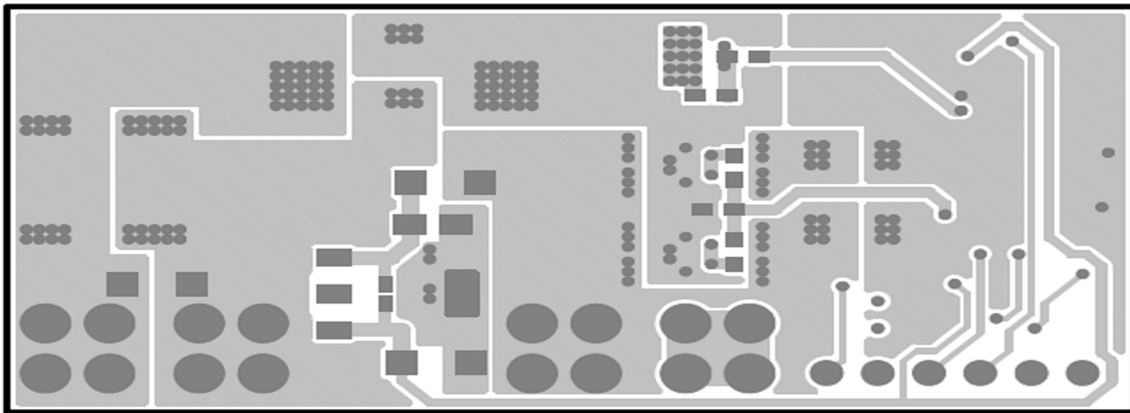


Figure 15. Bottom Copper Layer

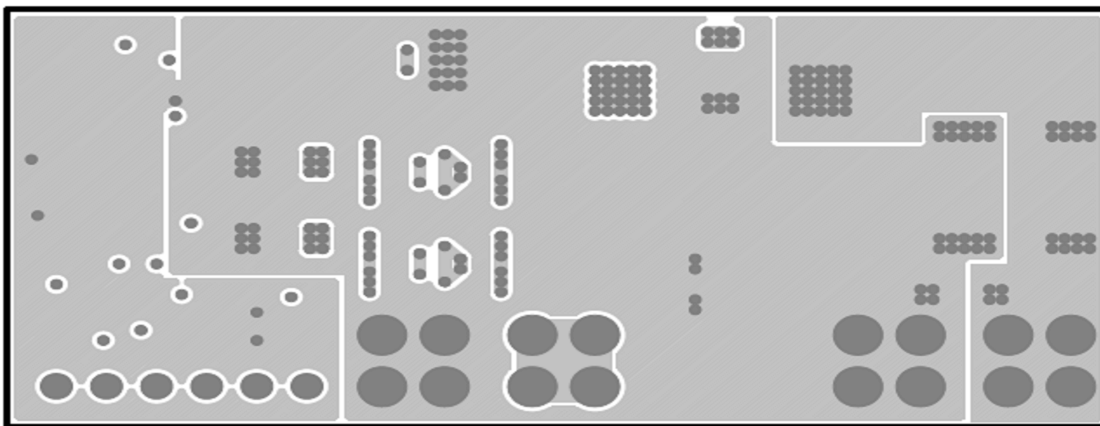


Figure 16. Internal Layer-1 (GND Copper)

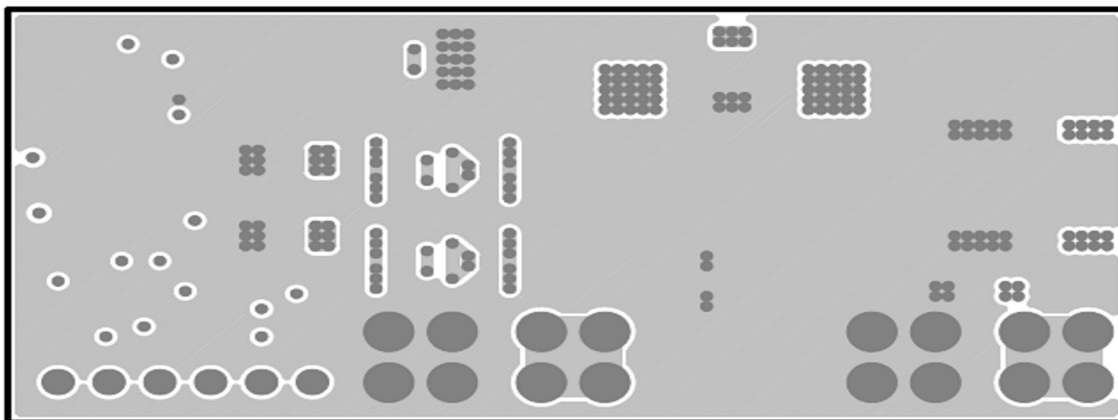


Figure 17. Internal Layer-2 (GND Copper)



## IMPORTANT NOTICE

Texas Instruments Incorporated and its subsidiaries (TI) reserve the right to make corrections, enhancements, improvements and other changes to its semiconductor products and services per JESD46, latest issue, and to discontinue any product or service per JESD48, latest issue. Buyers should obtain the latest relevant information before placing orders and should verify that such information is current and complete. All semiconductor products (also referred to herein as "components") are sold subject to TI's terms and conditions of sale supplied at the time of order acknowledgment.

TI warrants performance of its components to the specifications applicable at the time of sale, in accordance with the warranty in TI's terms and conditions of sale of semiconductor products. Testing and other quality control techniques are used to the extent TI deems necessary to support this warranty. Except where mandated by applicable law, testing of all parameters of each component is not necessarily performed.

TI assumes no liability for applications assistance or the design of Buyers' products. Buyers are responsible for their products and applications using TI components. To minimize the risks associated with Buyers' products and applications, Buyers should provide adequate design and operating safeguards.

TI does not warrant or represent that any license, either express or implied, is granted under any patent right, copyright, mask work right, or other intellectual property right relating to any combination, machine, or process in which TI components or services are used. Information published by TI regarding third-party products or services does not constitute a license to use such products or services or a warranty or endorsement thereof. Use of such information may require a license from a third party under the patents or other intellectual property of the third party, or a license from TI under the patents or other intellectual property of TI.

Reproduction of significant portions of TI information in TI data books or data sheets is permissible only if reproduction is without alteration and is accompanied by all associated warranties, conditions, limitations, and notices. TI is not responsible or liable for such altered documentation. Information of third parties may be subject to additional restrictions.

Resale of TI components or services with statements different from or beyond the parameters stated by TI for that component or service voids all express and any implied warranties for the associated TI component or service and is an unfair and deceptive business practice. TI is not responsible or liable for any such statements.

Buyer acknowledges and agrees that it is solely responsible for compliance with all legal, regulatory and safety-related requirements concerning its products, and any use of TI components in its applications, notwithstanding any applications-related information or support that may be provided by TI. Buyer represents and agrees that it has all the necessary expertise to create and implement safeguards which anticipate dangerous consequences of failures, monitor failures and their consequences, lessen the likelihood of failures that might cause harm and take appropriate remedial actions. Buyer will fully indemnify TI and its representatives against any damages arising out of the use of any TI components in safety-critical applications.

In some cases, TI components may be promoted specifically to facilitate safety-related applications. With such components, TI's goal is to help enable customers to design and create their own end-product solutions that meet applicable functional safety standards and requirements. Nonetheless, such components are subject to these terms.

No TI components are authorized for use in FDA Class III (or similar life-critical medical equipment) unless authorized officers of the parties have executed a special agreement specifically governing such use.

Only those TI components which TI has specifically designated as military grade or "enhanced plastic" are designed and intended for use in military/aerospace applications or environments. Buyer acknowledges and agrees that any military or aerospace use of TI components which have **not** been so designated is solely at the Buyer's risk, and that Buyer is solely responsible for compliance with all legal and regulatory requirements in connection with such use.

TI has specifically designated certain components as meeting ISO/TS16949 requirements, mainly for automotive use. In any case of use of non-designated products, TI will not be responsible for any failure to meet ISO/TS16949.

### Products

Audio	<a href="http://www.ti.com/audio">www.ti.com/audio</a>
Amplifiers	<a href="http://amplifier.ti.com">amplifier.ti.com</a>
Data Converters	<a href="http://dataconverter.ti.com">dataconverter.ti.com</a>
DLP® Products	<a href="http://www.dlp.com">www.dlp.com</a>
DSP	<a href="http://dsp.ti.com">dsp.ti.com</a>
Clocks and Timers	<a href="http://www.ti.com/clocks">www.ti.com/clocks</a>
Interface	<a href="http://interface.ti.com">interface.ti.com</a>
Logic	<a href="http://logic.ti.com">logic.ti.com</a>
Power Mgmt	<a href="http://power.ti.com">power.ti.com</a>
Microcontrollers	<a href="http://microcontroller.ti.com">microcontroller.ti.com</a>
RFID	<a href="http://www.ti-rfid.com">www.ti-rfid.com</a>
OMAP Applications Processors	<a href="http://www.ti.com/omap">www.ti.com/omap</a>
Wireless Connectivity	<a href="http://www.ti.com/wirelessconnectivity">www.ti.com/wirelessconnectivity</a>

### Applications

Automotive and Transportation	<a href="http://www.ti.com/automotive">www.ti.com/automotive</a>
Communications and Telecom	<a href="http://www.ti.com/communications">www.ti.com/communications</a>
Computers and Peripherals	<a href="http://www.ti.com/computers">www.ti.com/computers</a>
Consumer Electronics	<a href="http://www.ti.com/consumer-apps">www.ti.com/consumer-apps</a>
Energy and Lighting	<a href="http://www.ti.com/energy">www.ti.com/energy</a>
Industrial	<a href="http://www.ti.com/industrial">www.ti.com/industrial</a>
Medical	<a href="http://www.ti.com/medical">www.ti.com/medical</a>
Security	<a href="http://www.ti.com/security">www.ti.com/security</a>
Space, Avionics and Defense	<a href="http://www.ti.com/space-avionics-defense">www.ti.com/space-avionics-defense</a>
Video and Imaging	<a href="http://www.ti.com/video">www.ti.com/video</a>

### TI E2E Community

[e2e.ti.com](http://e2e.ti.com)