

# NCP2823AGEVB, NCP2823BGEVB



ON Semiconductor®

<http://onsemi.com>

## NCP2823 Series Evaluation Board User's Manual

### EVAL BOARD USER'S MANUAL

#### Overview

The NCP2823A/B are cost effective mono audio power amplifiers designed for portable electronic devices. NCP2823A is optimized for 8  $\Omega$  operation and NCP2823B can operate with speaker impedance down to 4.0  $\Omega$ . For Instance, NCP2823B is capable of delivering 3 W of continuous average power to a 4.0  $\Omega$  from a 5.0 V supply in a Bridge Tied Load (BTL) configuration. Under the same conditions, NCP2823A can provide 1.5 W to an 8.0  $\Omega$  BTL load with less than 1% THD+N. For cellular handsets or

PDA's it offers space and cost savings because no output filter is required when using inductive transducers. With more than 95% efficiency and very low shutdown current, it increases the lifetime of your battery and drastically lowers the junction temperature.

The intent of the evaluation boards is to illustrate typical operation of the NCP2823 device for laboratory characterization. The NCP2823 Series Evaluation Board schematic is depicted in Figure 3.

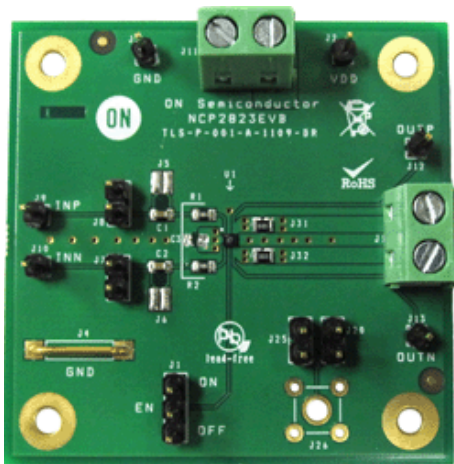

Figure 1. NCP2823AGEVB Board Picture

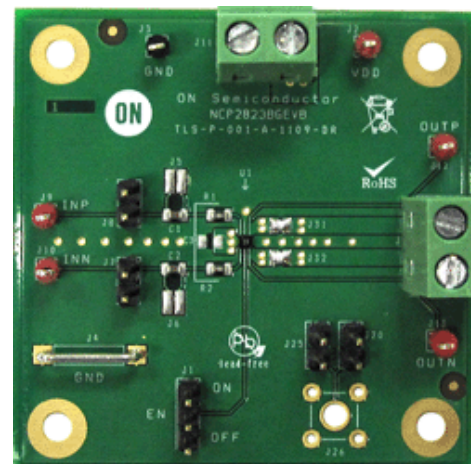

Figure 2. NCP2823BGEVB Board Picture

# NCP2823AGEVB, NCP2823BGEVB

## BOARD SCHEMATIC

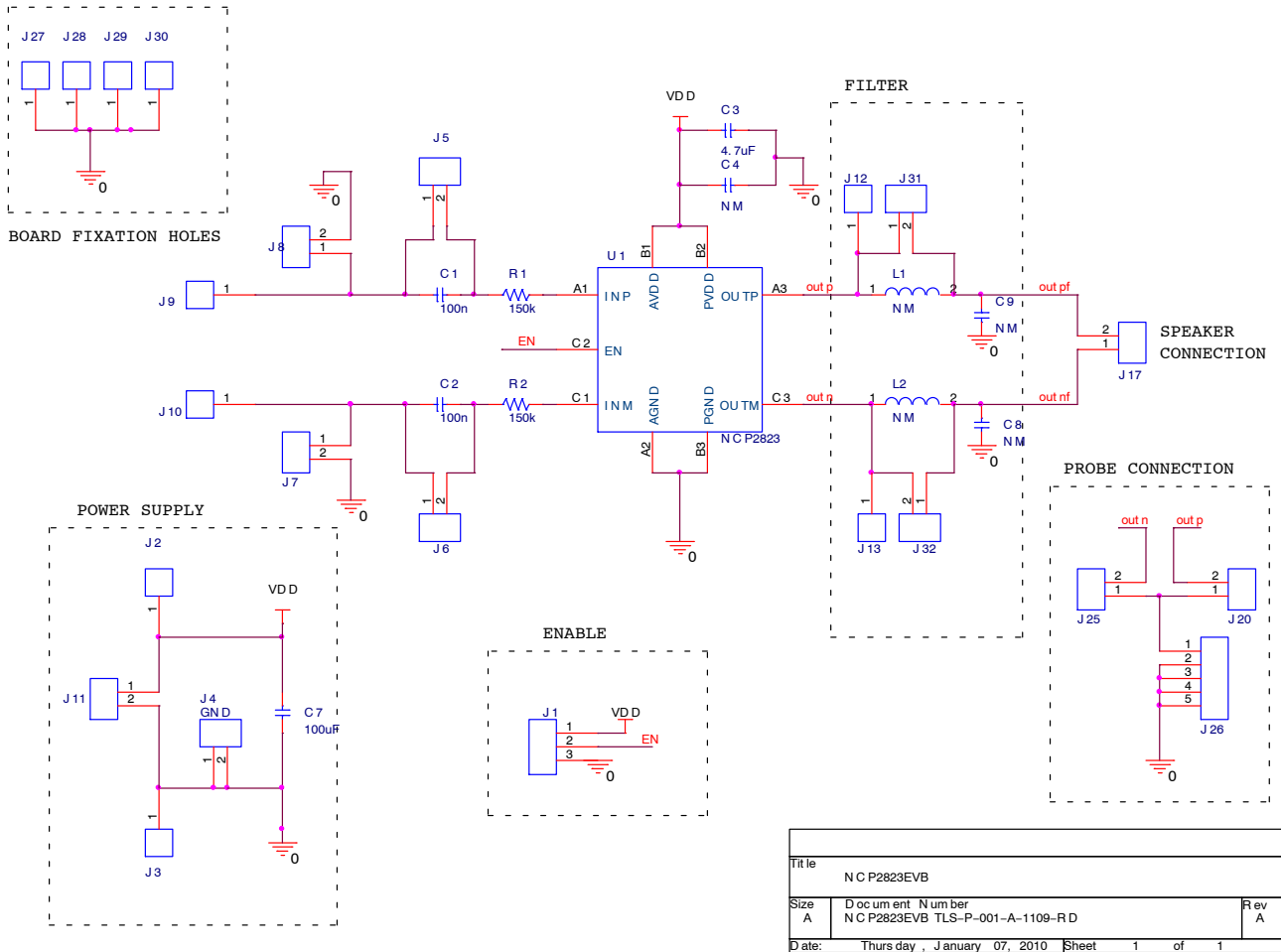

Figure 3. NCP2823 Series Evaluation Board Schematic

## OPERATION

The operating power supply of the NCP2823 is from 2.5 to 5.5 V. The absolute maximum input voltage is 7.0 V. A power supply set to 3.6 V and current limit set to at least 1.5 A must be connected to J11 connector to power the NCP2823 Series Evaluation Board. Also to compensate for parasitic inductance of wires between the power supply and the evaluation board it is highly recommended to connect a 470  $\mu$ F electrolytic capacitor to bypass J11 terminal. Like this the device can be evaluate under powering condition very similar that battery power supplies.

## Performances of EVB Solution

To be as close as possible with final handset application, the design of this power conversion solution used small size footprints where possible. Changing components may positively or negatively impact the evaluation board performance, illustrated in Figure 4 to 9. For more information please refer to the NCP2823 datasheet.

# NCP2823AGEVB, NCP2823BGEVB

**Table 1. BOARD CONNECTIONS**

## INPUT POWER

Symbol	Descriptions
J11-1	This is the positive connection for power supply. The leads (positive + ground) to the input supply should be twisted and kept as short as possible.
J11-2	This is the return connection for the power supply (Ground signal)
J4	Ground clip

## AUDIO

Symbol	Descriptions
J9	Positive Audio input
J10	Negative Audio input
J17-2	Positive Audio output
J17-1	Negative Audio output

## SWITCHES SETUP

Symbol	Switch Descriptions
J1	Enable
J5	Short input capacitor on positive input
J6	Short input capacitor on negative input
J7	Connect the positive audio input to Gnd
J8	Connect the negative audio input to Gnd
J31	Short filter on positive output
J32	Short filter on negative output
J25	Connect negative output to Probe connection (J26)
J20	Connect Positive output to Probe connection (J26)

## TEST POINT

Symbol	Switch Descriptions
J3	This test point is directly connected to the GND
J2	This test point is directly connected to the Vdd pin
J9	This test point is connected to the positive audio input
J10	This test point is connected to the negative audio input
J12	This test point is connected to the positive audio output
J13	This test point is connected to the negative audio output
J26	Probe connection

# NCP2823AGEVB, NCP2823BGEVB

## TYPICAL OPERATING CHARACTERISTICS

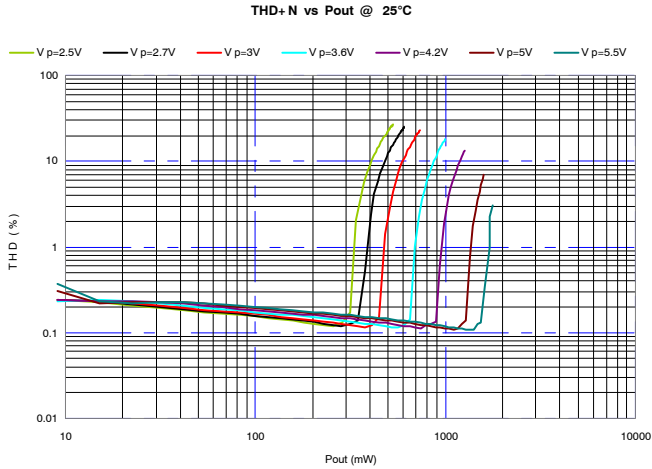

Figure 4. THD vs.  $P_{OUT}$ ,  $R_I = 8 \Omega$ ,  $f = 1 \text{ kHz}$

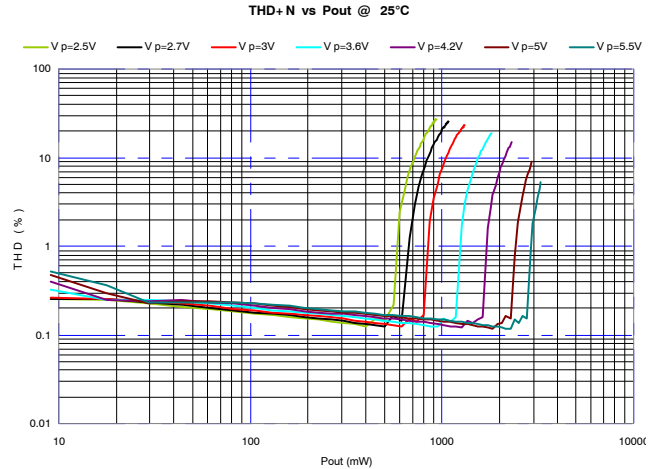

Figure 5. THD vs.  $P_{OUT}$ ,  $R_I = 4 \Omega$ ,  $f = 1 \text{ kHz}$

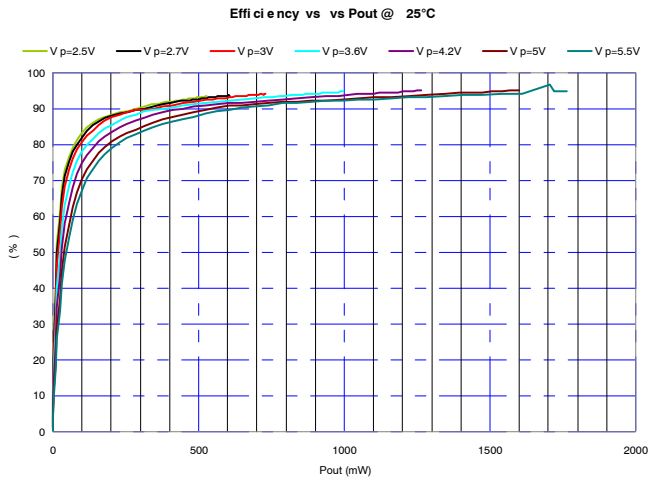

Figure 6. Efficiency vs.  $P_{OUT}$ ,  $R_I = 8 \Omega$ ,  $f = 1 \text{ kHz}$

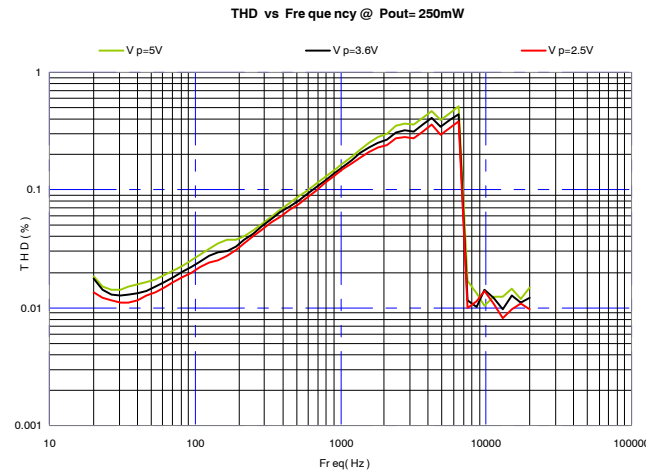

Figure 7. THD vs. Frequency,  $R_I = 8 \Omega$ ,  $P_{OUT} = 250 \text{ mW}$

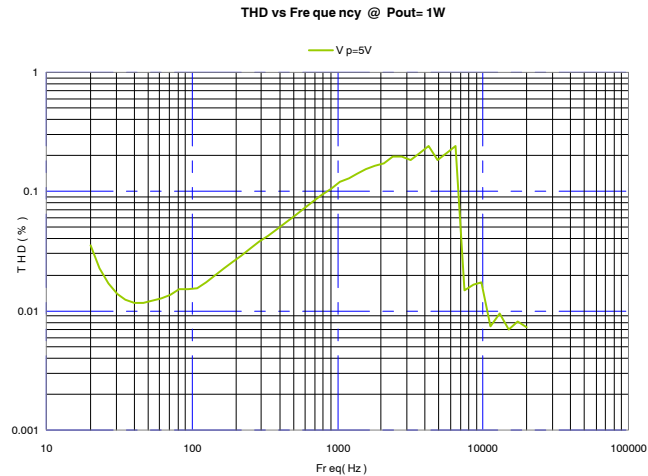

Figure 8. THD vs. Frequency,  $R_I = 8 \Omega$ ,  $P_{OUT} = 1 \text{ W}$

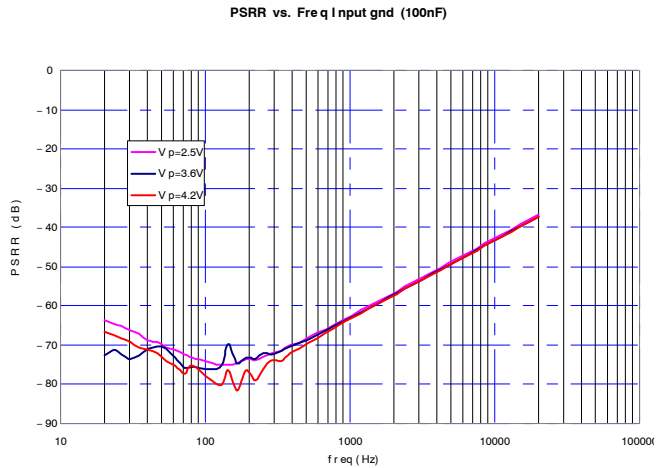

Figure 9. PSRR vs. Frequency

# NCP2823AGEVB, NCP2823BGEVB

## PCB LAYOUT

As with all Class D amplifier, care must have been observed to place the components on the PCB and layout the critical nodes. The evaluation board is made of 4 PCB layers where first internal layer is a GND. Figure 10, Figure 12 and

Figure 13 show the layout of the NCP2823 Series evaluation board. For more specific layout guidelines please refer to the NCP2823 datasheet.

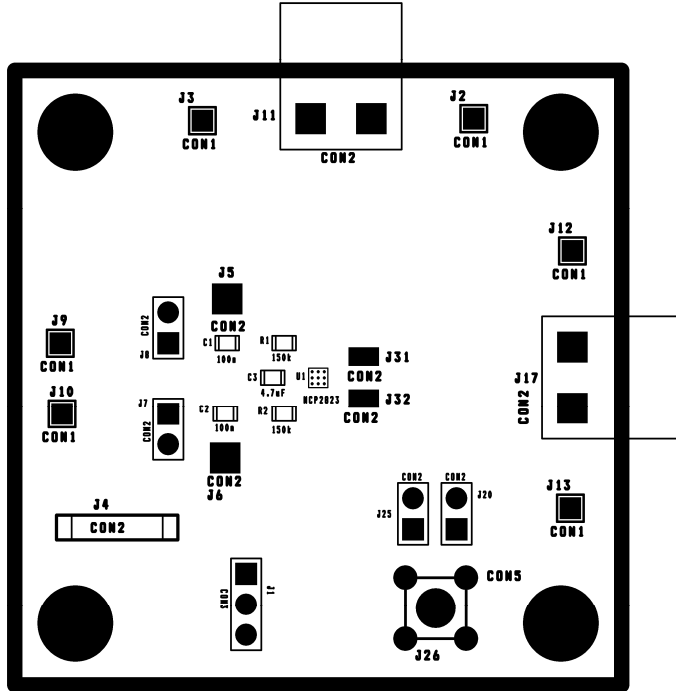

Figure 10. Assembly Layer TOP

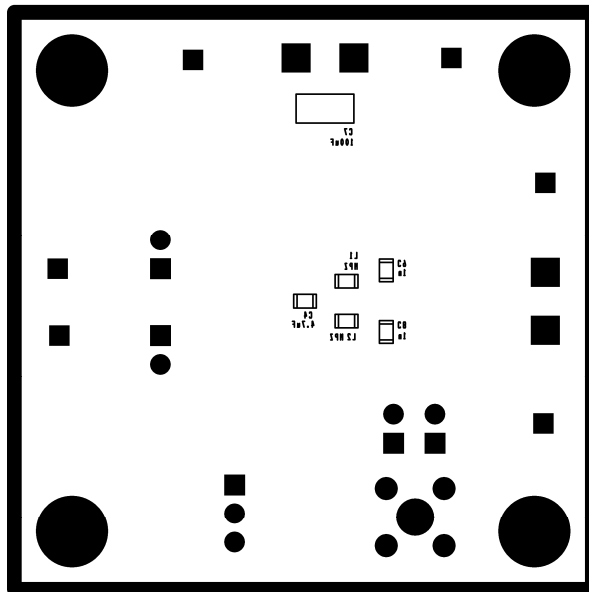

Figure 11. Assembly Layer BOTTOM

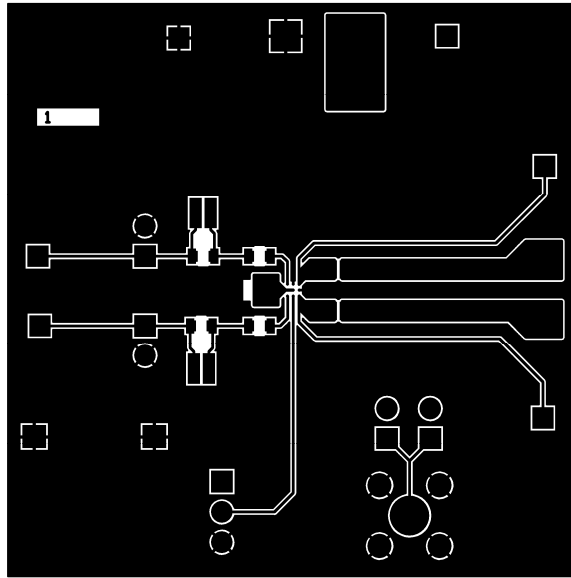

Figure 12. Top Layer Routing

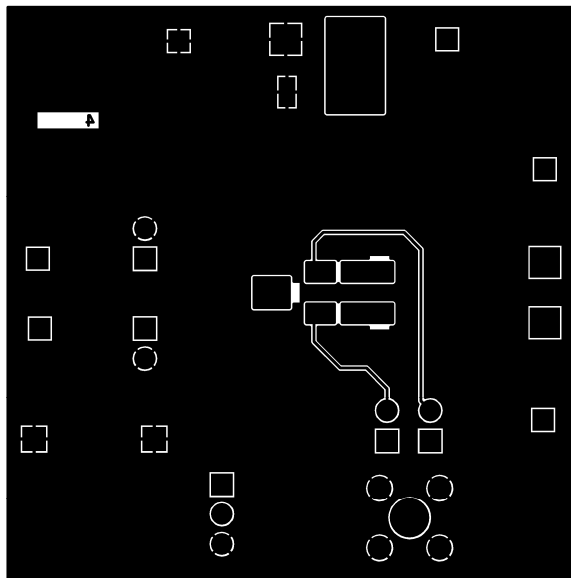

Figure 13. Bottom Layer Routing

# NCP2823AGEVB, NCP2823BGEVB

**Table 2. BILL OF MATERIALS**

Qty	Ref Des.	Description	Size	Manufacturer	Part Number
1	U1	NCP2823	CSP-9 1.45 x 1.45 mm	ON Semiconductor	NCP2823
2	C1, C2	Capacitor, Ceramic 100 nF	0603	KEMET	C0603C104K5RAC
2	C4	Capacitor, Ceramic 4.7 $\mu$ F 6.3 V	0603	KEMET	C0603C475K9PAC
2	R1, R2	Resistor 150k 1%	0603	Std	Any supplier possible
2	J11, J17	Mal. SL5.08/2/90B plus Fem. BLZ 5.08/2		Weidmuller	SL5.08/2/90 + BLZ 5.08/2
3	J1	Header 3 pin, 100 mil spacing	0.100 x 2	Std	Std
2	J7, J8	Header 2 pin, 100 mil spacing	0.100 x 2	Std	Std
1	J7	GND Connection		Std	Std
9	J2, J3, J9, J10, J12, J13	Test Point		Std	Std
2	J31, J32	Soldering point must be connected			
1	PCB	PCB 2.0 in x 2.0 in x 1.0 mm, 4 Layers		Any	TLS-P-001-A-1109-RD

NOTE: Component J20, J25, J26, L1, L2, C8 and C9 are not mounted on this demokit.

## ASSEMBLY TEST PROCEDURE

A power supply set to 3.6 V and current limit set to at least 1.5 A must be connected to J15 connector to powering the NCP2823 Series evaluation board. Also to compensate for parasitic inductance of wires between the power supply and the evaluation board it is highly recommended to connect a 470  $\mu$ F electrolytic capacitor to bypass J11 terminal. Like this the device can be evaluate under powering condition very similar that battery power supplies.

These tests are provided in order to guarantee a good assembly of the NCP2823 on its dedicated board, it do not consist in parametric test which is already done at chip level.

### SHUTDOWN TEST

Switches setup for shutdown test:

Symbol	Switch Description
J1	Must be connected to ground (low side)

\*All other switches must be kept floating

Tests:

1. Set the switches in the configuration
2. Power the board with a 3.6 V power supply limited at 1.5A and bypassed by a 470  $\mu$ F electrolytic capacitor.
3. Measure the current on the power supply (must be inferior to 1  $\mu$ A)

### Wake up test

Switches setup for wire mode test:

Symbol	Switch Description
J1	Must be connected to VDD (high side)

\*All other switches must be kept floating

Tests:

4. Set the switches in the configuration
5. Power the board with a 3.6 V power supply limited at 1.5 A and bypassed by a 470  $\mu$ F electrolytic capacitor.
6. Measure DC Output voltage on J12 on J13 and GND. DC Voltage must be equal to 1.8 V
7. Measure DC input voltage on J5-2 on J6-2 and GND. DC Voltage must be equal to 1.26 V

### SUMMARY

Test	Measurement	Switch Description
Shutdown test	I Supply	I < 1 $\mu$ A
Wake up test	VOUTP, VOUTN VJ9, VJ10	VDC = 1.8 V VDC = 1.26 V

NOTE: For each board a Test Result Table must be fully completed (see the next page)

# NCP2823AGEVB, NCP2823BGEVB

## TEST RESULT TABLE

NCP2823 Assembly Test				
Date		Operator Name		
Board Serial Number				
Test No.	Test Name	Results	Value	
1	Shutdown mode test	I Supply		
2	Wake up test	VoutP, VoutN	1.8	
		VJ9, VJ10	1.26	



**onsemi**, **Onsemi**, and other names, marks, and brands are registered and/or common law trademarks of Semiconductor Components Industries, LLC dba "**onsemi**" or its affiliates and/or subsidiaries in the United States and/or other countries. **onsemi** owns the rights to a number of patents, trademarks, copyrights, trade secrets, and other intellectual property. A listing of **onsemi**'s product/patent coverage may be accessed at [www.onsemi.com/site/pdf/Patent-Marking.pdf](http://www.onsemi.com/site/pdf/Patent-Marking.pdf). **onsemi** is an Equal Opportunity/Affirmative Action Employer. This literature is subject to all applicable copyright laws and is not for resale in any manner.

The evaluation board/kit (research and development board/kit) (hereinafter the "board") is not a finished product and is not available for sale to consumers. The board is only intended for research, development, demonstration and evaluation purposes and will only be used in laboratory/development areas by persons with an engineering/technical training and familiar with the risks associated with handling electrical/mechanical components, systems and subsystems. This person assumes full responsibility/liability for proper and safe handling. Any other use, resale or redistribution for any other purpose is strictly prohibited.

**THE BOARD IS PROVIDED BY ONSEMI TO YOU "AS IS" AND WITHOUT ANY REPRESENTATIONS OR WARRANTIES WHATSOEVER. WITHOUT LIMITING THE FOREGOING, ONSEMI (AND ITS LICENSORS/SUPPLIERS) HEREBY DISCLAIMS ANY AND ALL REPRESENTATIONS AND WARRANTIES IN RELATION TO THE BOARD, ANY MODIFICATIONS, OR THIS AGREEMENT, WHETHER EXPRESS, IMPLIED, STATUTORY OR OTHERWISE, INCLUDING WITHOUT LIMITATION ANY AND ALL REPRESENTATIONS AND WARRANTIES OF MERCHANTABILITY, FITNESS FOR A PARTICULAR PURPOSE, TITLE, NON-INFRINGEMENT, AND THOSE ARISING FROM A COURSE OF DEALING, TRADE USAGE, TRADE CUSTOM OR TRADE PRACTICE.**

**onsemi** reserves the right to make changes without further notice to any board.

You are responsible for determining whether the board will be suitable for your intended use or application or will achieve your intended results. Prior to using or distributing any systems that have been evaluated, designed or tested using the board, you agree to test and validate your design to confirm the functionality for your application. Any technical, applications or design information or advice, quality characterization, reliability data or other services provided by **onsemi** shall not constitute any representation or warranty by **onsemi**, and no additional obligations or liabilities shall arise from **onsemi** having provided such information or services.

**onsemi** products including the boards are not designed, intended, or authorized for use in life support systems, or any FDA Class 3 medical devices or medical devices with a similar or equivalent classification in a foreign jurisdiction, or any devices intended for implantation in the human body. You agree to indemnify, defend and hold harmless **onsemi**, its directors, officers, employees, representatives, agents, subsidiaries, affiliates, distributors, and assigns, against any and all liabilities, losses, costs, damages, judgments, and expenses, arising out of any claim, demand, investigation, lawsuit, regulatory action or cause of action arising out of or associated with any unauthorized use, even if such claim alleges that **onsemi** was negligent regarding the design or manufacture of any products and/or the board.

This evaluation board/kit does not fall within the scope of the European Union directives regarding electromagnetic compatibility, restricted substances (RoHS), recycling (WEEE), FCC, CE or UL, and may not meet the technical requirements of these or other related directives.

FCC WARNING – This evaluation board/kit is intended for use for engineering development, demonstration, or evaluation purposes only and is not considered by **onsemi** to be a finished end product fit for general consumer use. It may generate, use, or radiate radio frequency energy and has not been tested for compliance with the limits of computing devices pursuant to part 15 of FCC rules, which are designed to provide reasonable protection against radio frequency interference. Operation of this equipment may cause interference with radio communications, in which case the user shall be responsible, at its expense, to take whatever measures may be required to correct this interference.

**onsemi** does not convey any license under its patent rights nor the rights of others.

LIMITATIONS OF LIABILITY: **onsemi** shall not be liable for any special, consequential, incidental, indirect or punitive damages, including, but not limited to the costs of requalification, delay, loss of profits or goodwill, arising out of or in connection with the board, even if **onsemi** is advised of the possibility of such damages. In no event shall **onsemi**'s aggregate liability from any obligation arising out of or in connection with the board, under any theory of liability, exceed the purchase price paid for the board, if any.

The board is provided to you subject to the license and other terms per **onsemi**'s standard terms and conditions of sale. For more information and documentation, please visit [www.onsemi.com](http://www.onsemi.com).

## ADDITIONAL INFORMATION

### TECHNICAL PUBLICATIONS:

Technical Library: [www.onsemi.com/design/resources/technical-documentation](http://www.onsemi.com/design/resources/technical-documentation)  
onsemi Website: [www.onsemi.com](http://www.onsemi.com)

ONLINE SUPPORT: [www.onsemi.com/support](http://www.onsemi.com/support)

For additional information, please contact your local Sales Representative at [www.onsemi.com/support/sales](http://www.onsemi.com/support/sales)