

FEATURES

**Full-featured evaluation board for the AD7764/AD7765
EVAL-CED1Z compatible
On-board 4.096 V reference
PC software for control and data analysis for
use with EVAL-CED1Z**

EVALUATION BOARD DESCRIPTION

This data sheet describes the evaluation board for the AD7764/AD7765 Σ - Δ ADCs. The AD7764/5 is a 24-bit ADC, serial data output with multiple decimation rate options incorporating a full band digital FIR filter. It combines wide input bandwidth with the benefits of Σ - Δ conversion with a performance of 102/104 dB SNR at 312ksps/156ksps respectively. The AD7764/AD7765 devices are ideal for applications like vibration monitoring, sonar, and general data acquisition where anti-alias protection is of importance.

Complete specifications for the AD7764/AD7765 devices are available in the AD7764/AD7765 data sheets available from Analog Devices, Inc., and should be consulted in conjunction with this data sheet when using the evaluation board.

The EVAL-AD7764/AD7765EDZ is controlled using the EVAL-CED1Z Converter Evaluation and development board. The CED

board outputs the MCLK signal which the AD7764/5 use to sample the analog inputs.

The AD7764/AD7765 evaluation board interfaces directly with the FPGA located on the CED board via the SPORT header. The combination of the EVAL-CED1Z board allied with the EVAL-AD7764/AD7765/EDZ software allows the user to upload samples taken by the AD7764/AD7765 device onto a PC showing the waveform being sampled, as well as allowing the data to be shown in histogram or FFT format. The EVAL-AD7764/AD7765/4EDZ can also be used on a standalone basis (without EVAL-CED1Z); however, in this case the user must provide the required interface signals.

CONTENTS OF EVALUATION KIT

- AD7764/AD7765 evaluation board (EVAL-AD7764/AD7765EDZ)
- EVAL-AD776xEDZ evaluation software CD—Software executable
 - Software executable
 - Labview Source Code
 - FPGA source code

EVALUATION BOARD BLOCK DIAGRAM

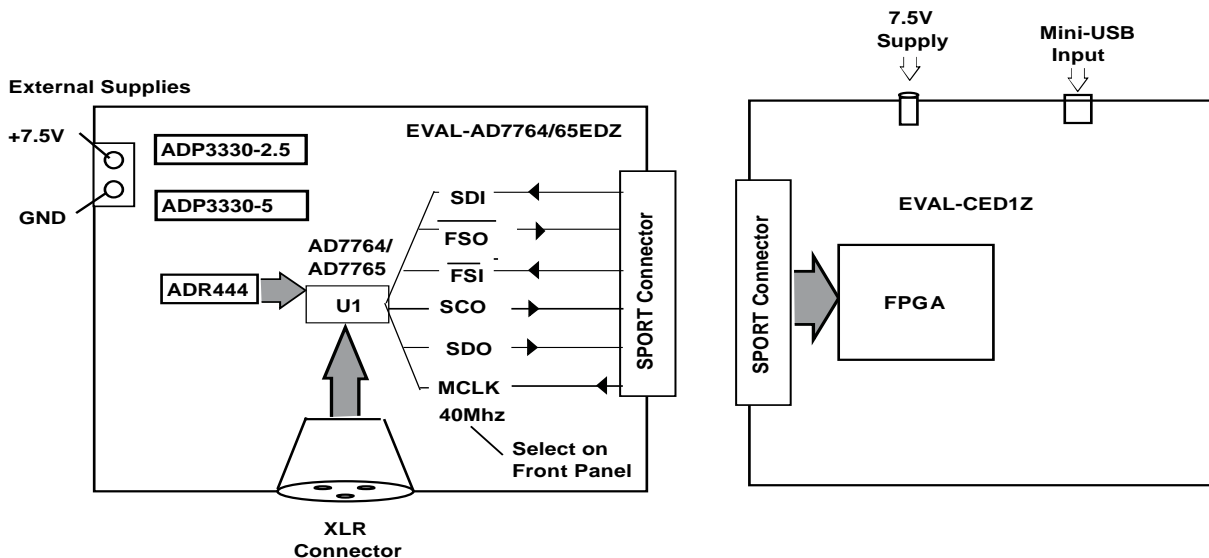

Figure 1. Evaluation set-up Block Diagram

Rev. PrC

Information furnished by Analog Devices is believed to be accurate and reliable. However, no responsibility is assumed by Analog Devices for its use, nor for any infringements of patents or other rights of third parties that may result from its use. Specifications subject to change without notice. No license is granted by implication or otherwise under any patent or patent rights of Analog Devices. Trademarks and registered trademarks are the property of their respective owners.

TABLE OF CONTENTS

Features	1	Software Instructions for First-Time Use.....	5
Evaluation Board Description.....	1	Installing the Software	5
Contents of Evaluation Kit	1	Using the evaluation System	7
Evaluation Board Block Diagram.....	1	Hardware connections.....	7
Hardware Description.....	3	Software Instructions for Normal Use.....	9
Power Supplies	3	Source FPGA and Labview Code.....	10
Differential Input.....	3	Evaluation Board Schematic and Artwork.....	11
Reference circuit	3	Ordering Information.....	20
Standalone Operation	3	Bill of Materials.....	20
Decoupling and Layout Recommendations.....	3	Ordering Guide	22
Link Options	4	ESD Caution.....	22

HARDWARE DESCRIPTION

POWER SUPPLIES

The EVAL-AD7764/5EDZ must be powered using a power supply that applies a 7.5 V between the V+ and GND terminals of Connector J2.

This 7.5 V supply is then regulated on board using ADP3330-2.5 ADP3330-5 devices (U5 and U3) to provide the 2.5 V and 5 V signals required by the AD7764/AD7765 device.

A filter path of the 2.5 V supply is used to power other digital functionality on the EVAL-AD7764/AD7765EDZ excluding the AD7764/AD7765 device. A separately filtered 5 V supply also supplies the crystal oscillator on the EVAL-AD7764/AD7765EDZ. The crystal oscillator is provided for customers that wish to use the device in a stand-alone manner where they wish to provide and acquire the digital signals going to and from the AD7764/5 device. For this case, the user may apply the MCLK sourced from the crystal oscillator. Note that in the default mode the AD7764/5 evaluation board is set up so that the EVAL-CED1Z board provides the MCLK signal to the ADC as well as providing and acquiring all other digital signals for the evaluation system.

DIFFERENTIAL INPUT

The differential input to the AD7764/AD7765 device is applied through the connector marked J1. This is an XLR audio standard connector. The differential inputs are routed through the AD7764/AD7765 on-board differential amplifier using the external circuit components as detailed in the schematic as shown in this technical note and the AD7764/AD7765 data sheets.

REFERENCE CIRCUIT

The AD7764/5 evaluation board uses the low noise ADR444 (4.096V) reference to supply the ADC. See Gerber files on

AD7764/5 product pages on www.analog.com for details on the layout and configuration for this reference supply.

STANDALONE OPERATION

The EVAL-AD7764/AD7765EDZ can be used in a standalone manner (that is, without using the EVAL-CED1Z). In this case, however, the user must provide all the required interface communications and be able to provide a means to acquire the output. SMB footprints, allow for external MCLK, SYNC, RESET and Decimation rate signals to be applied to the AD7764/65 device. All other digital signals are accessible either from the 34-pin header (J4) or from the marked test points on the evaluation board.

DECOUPLING AND LAYOUT RECOMMENDATIONS

The data sheets of the AD7764/AD7765 devices contain specific information about the decoupling and layout recommendations required to achieve the optimum specifications.

The EVAL-AD7764/AD7765EDZ adheres to these recommendations and is designed as the blueprint for users of the AD7764/Ad7765 devices.

The EVAL-AD7764/AD7765EDZ are 4-layer boards. One layer is a dedicated ground plane. All supplies to devices on the EVAL-AD7764/AD7765EDZ are decoupled to this ground plane. In addition to the PCB's top and bottom layers, there is also a layer for routing power signals. All layers of the board are detailed in the Evaluation Board Schematic and Artwork section.

LINK OPTIONS

The link options on the evaluation board should be set for the required operating setup before using the board. The functions of these links are described in Table 1.

Table 1. Link Options

Link No.	Function	Position Descriptions	Default
R8, R29, R11	A 0 Ω link must be placed in either pair of resistors, R11, R29, or R8 to select the MCLK source for the AD7764/AD7765 device.	R11 routes the MCLK frequency from the EVAL-CED1Z board to the MCLK pin of the AD7764/AD7765 device. This is the default R29 or R8 allows the user to input an external MCLK signal through the MCLK SMB connector (J17) or connect to the 40MHz Crystal oscillator for use in stand-alone mode.	R11
R15, R16, R17, R33, R34, R35, R36, R37	A 0 Ω link must be placed in all of these resistors placeholders to link the digital outputs of the AD7764/5 to the EVAL-CED1Z board.	Place a 0 Ω link in all of these positions.	All shorted with 0 Ω links.

SOFTWARE INSTRUCTIONS FOR FIRST-TIME USE

INSTALLING THE SOFTWARE

The EVAL-AD7764/AD7765 evaluation board includes self-installing software on CD ROM, for controlling and evaluating the performance of the AD7764/AD7765 when it is operated with the EVAL-CED1Z board. The software is compatible with Windows® 2000/XP®. If the setup file does not run automatically, setup.exe can be run from the CD-ROM.

When the CD is inserted into the PC, an installation program automatically begins. This program installs the evaluation software. The user interface on the PC is a dedicated program written especially for the AD7764/AD7765 when operating with the EVAL-CEDZ board.

The software should be installed before the USB cable is connected between the EVAL-CEDZ and the PC. This ensures that the appropriate USB driver files have been properly installed before the EVAL-CEDZ is connected to the PC.

When the software is run for the first time with the EVAL-CEDZ board connected to the PC, the PC will automatically find the new device and will identify it. Follow the onscreen instructions that appear automatically. This installs the drivers for the CED on the PC. If an error appears on screen when the software is first opened, then the PC is not recognizing the USB device. This error is corrected by

1. Opening the PC's Device Manager. The Device Manager is accessed by right clicking on the My Computer Icon, and selecting Properties. When the System Properties Window opens, select the Hardware tab.
2. Click on Device Manager in the Hardware Tab of the System Properties window.
3. Examine the devices listed under the Universal Serial Bus Controller heading.
4. If an unknown device is listed, right click on this option and select, Update Driver.
5. The New Hardware Wizard will run twice, and under the ADI Development Tools the following hardware is listed:

ADI Converter Evaluation and Development Board (WF)

6. Reboot the PC.

This section describes how the evaluation board, the EVAL-CEDZ and the software should be set up to begin using the complete system.

1. Insert the CD into the appropriate computer drive.
2. The dialog box shown in Figure 2 appears.

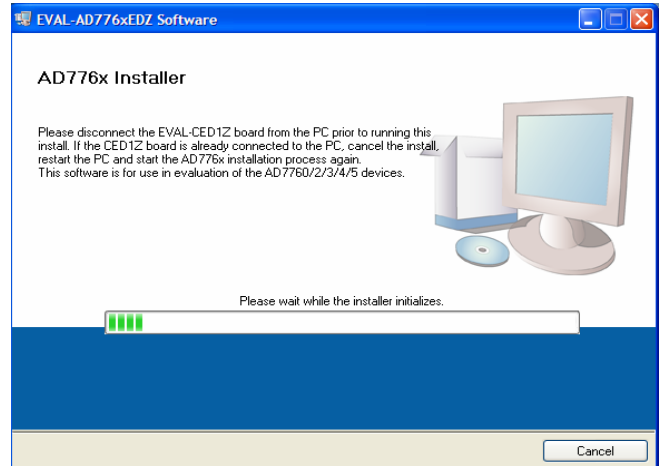

Figure 2. EVAL- AD7764/AD7765EDZ Setup Dialog Box, Initial Software Install Screen

3. The destination directory can be chosen using the default clicking “Next” as shown in Figure 3). If a different location than the default is preferred, click **Browse** and select the desired location. When ready, click **Next**.



Figure 3. Choose the Destination of the AD7764/AD7765 Software

4. Accept the license agreement by selecting the correct option and clicking “Next” as shown in Figure 4.

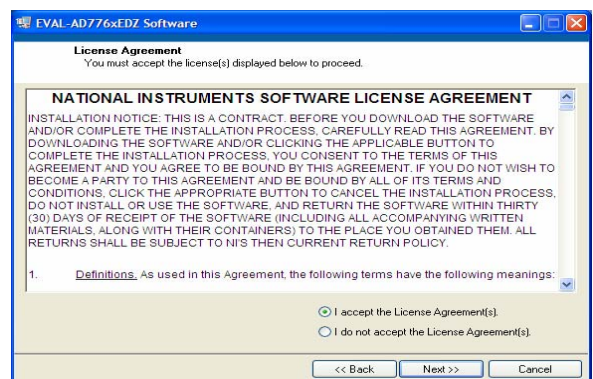

Figure 4. Accept license agreement

- 5. To start the installation, click the “Next” button as shown in Figure 5, this window details the actions of the installation.

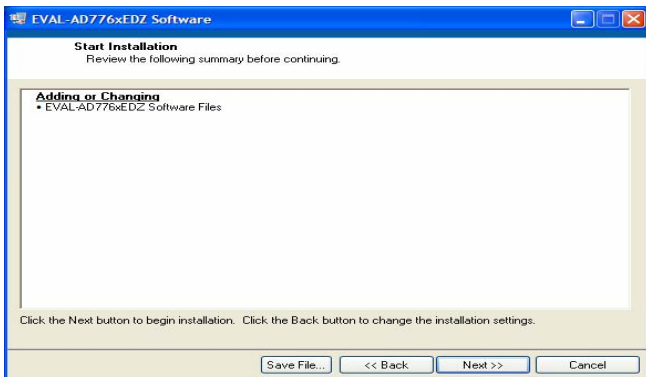

Figure 5. EVAL-AD776xEDZ Install actions

- 6.
- 7. The software can now be located by following the path that was chosen during installation. If the default location was chosen, the location of the software is **Start > All Programs > Analog Devices > AD7764_5**

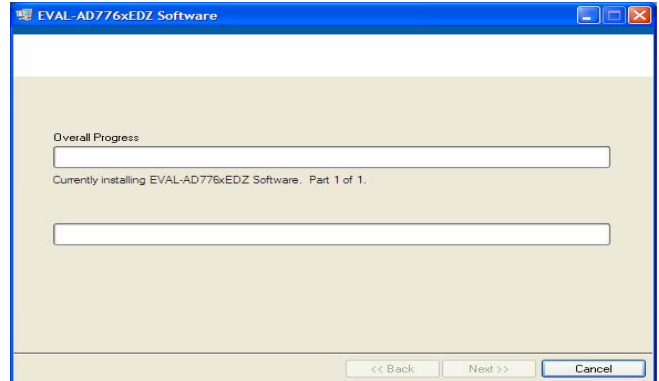

Figure 6. Default Location of AD7764/AD7765 Software

- 8. On completion of the installation, the window as shown in Figure 7 is displayed.

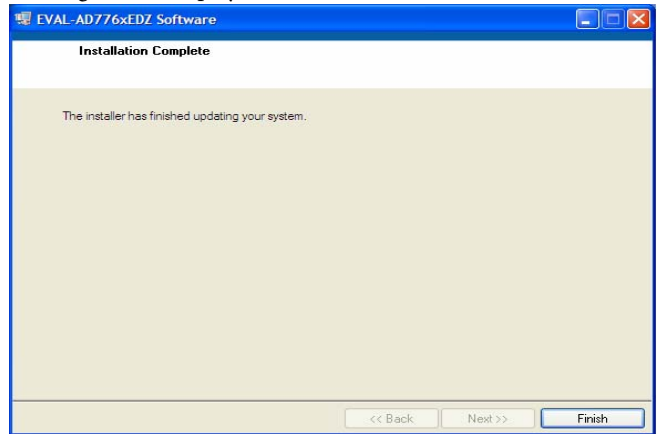

Figure 7. Install Completed

- 9. On completion of the installation it is advised that the user re-starts the PC in order for the software to take full effect.

USING THE EVALUATION SYSTEM

HARDWARE CONNECTIONS

1. Apply power to the EVAL-CED1Z via +7V, 15W power supply provided with the EVAL-CED1Z board. At this stage, the green LED labeled 'Power' on the EVAL-CED1Z should be lighting. This indicates that the EVAL-CED1Z is receiving power. The USB cable can then be connected between the PC and the EVAL-CED1Z.
2. Connect the USB cable between the PC and the EVAL-CED1Z. A green LED positioned beside the USB connector on the EVAL-CED1Z board will light indicating that the USB connection has been established.
3. Power up the EVAL-AD7764/AD7765EDZ evaluation board through Connector J2. Connect a wire from the V+ labeled connector to 7.5 V of an external power supply. Also ensure that there is a GND connection between the GND of J2 and the power supply GND connection.

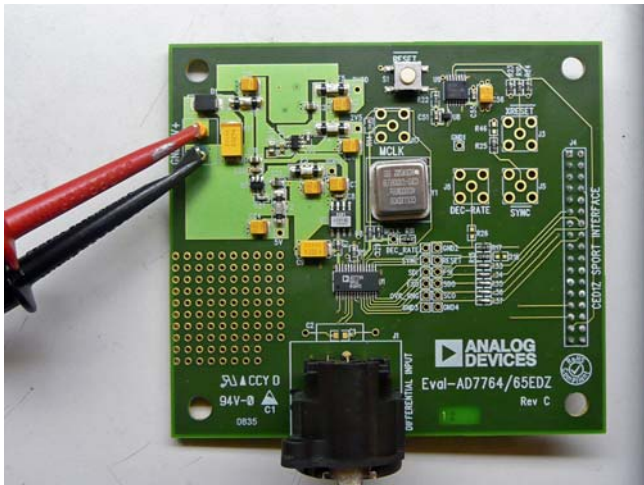

Figure 8. AD7764/65EDZ Evaluation board- Power applied to connector J2.

4. Connect the female connector (J4, marked "CED1Z SPORT Interface"), which is on the under side of the EVAL-AD7764/AD7765EB evaluation board to the SPORT header of the EVAL-CED1Z board. The SPORT header is located on the left hand side of the EVAL-CED1Z board and is marked in the silkscreen.

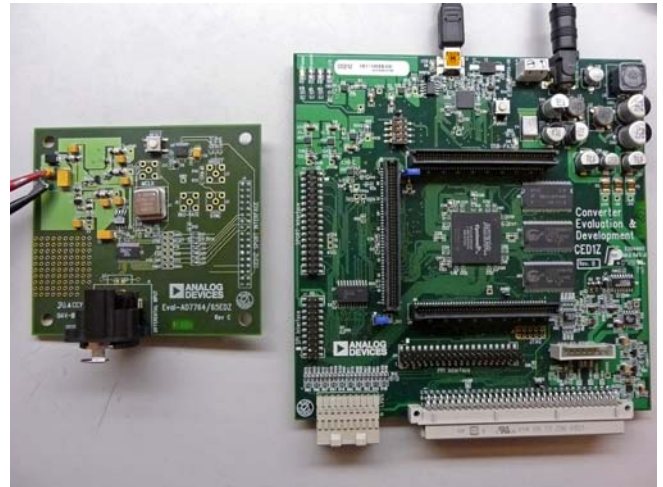

Figure 9. Lining up EVAL-AD7764/65EDZ with the EVAL-CED1Z SPORT connector. Both boards are powered up.

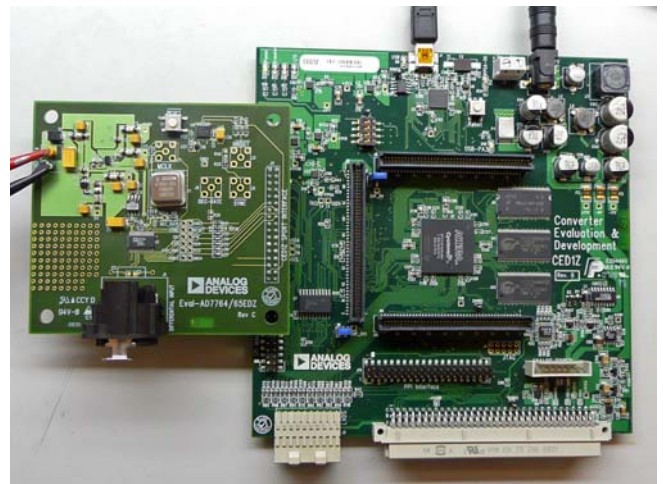

Figure 10. Connecting the EVAL-AD7764/AD7765 board to EVAL-CED1Z.

5. Start the EVAL-AD7764/AD7765EDZ software.

The differential input to the AD7764/AD7765 device can be connected to the black connector XLR connector (J1) marked "Differential Input." This differential input is routed to the inputs of the AD7764/AD7765/ on-board differential amplifier. As the software will power up the AD7764/5 device it is advisable that users do not apply an analog input until the device is fully powered up.

With the hardware set up, you can now use the software to control the EVAL-CED1Z and the AD7764/AD7765 evaluation board. To launch the software, from the **Analog Devices** menu click on the **AD7764_5** submenu, then click on the **AD7764_5 icon**.

Note: In the case where an Error message appears, click OK and restart the application after checking the connection between the adapter board and the USB port on the PC. Also, check that the USB device is identified by the Device Manager as detailed

in the first time use of EVAL-CED1Z paragraph of Installing the Software section.

SOFTWARE INSTRUCTIONS FOR NORMAL USE

Once the initial software installation has been completed, follow these instructions for the general setup of the evaluation software each subsequent time the system is used.

Note that the hardware must be powered up as per the Hardware connections section before attempting the following steps.

1. The download default location for the EVAL-AD7760/AD7762/AD7763EDZ evaluation software can be found by clicking **Start > All Programs > Analog Devices > AD7764_5 > AD7764_5**. If a location other than the default was used, follow the path that was entered during setup.
2. The evaluation software GUI appears.
3. Select the correct AD776x device from the drop down menu in the top left hand corner of the GUI. i.e. AD7764 for AD7764 evaluation, click AD7765 for AD7765 evaluation.
4. The AD7764/5device under evaluation should power up automatically when the software is run. Click the Power

Mode drop down menu, and select either ‘Low Power’ or ‘Normal Power’. This will automatically prompt the EVAL-CED1Z to write to the AD7764/AD7765 registers and set the power as per your preference for the AD7764/5 device.

5. Note that the external voltage supply connected to the EVAL-AD7764/AD7765EDZ board will show the current dropping when you switch between ‘Normal Power’ mode, ‘Low Power mode and “Power Down” mode. Seeing these current draw levels change, when switching between the power modes also verifies that the communication between the EVAL-AD7764/5EDZ and EVAL-CED1Z boards.
6. The user can specify the power mode, decimation rate, and number of samples to be acquired (typically 65536 samples) by using the drop-down menus on the software front panel circled in red in Figure 11. The software allows the number of samples specified by the user samples to be viewed as a waveform, histogram, or FFT. The Front panel is shown in Figure 11.

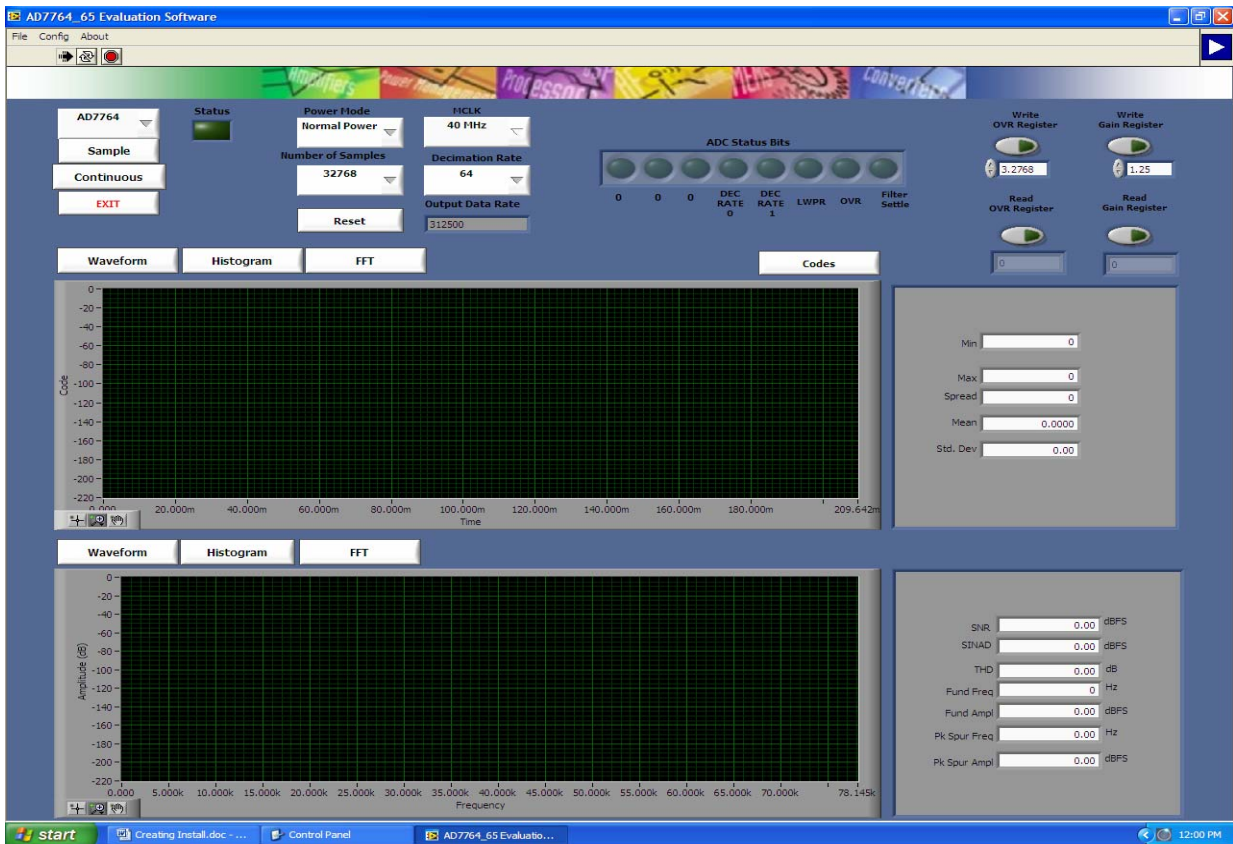

Figure 11. EVAL-AD7764/AD7765EDZ Evaluation Software Front Panel Features

7. For the initial operation of the AD7764 and AD7765 versions of the evaluation board, set the **Decimation Rate** to 64 or 128 respectively in the front panel of the **AD7764_5 Evaluation Software** dialog box. These are the default decimation rate of the AD7764/AD7765 parts on reset and power-up of the evaluation board.
8. As well as offering the user different decimation rates the front panel software also allows the user to select the MCLK frequency being applied to the AD7764/5 device. Options include 40MHz, 30MHz, 25MHz, and 20MHz. After selecting any of these MCLK frequencies, please monitor the MCLK test point on the evaluation board to ensure the MCLK has changed in accordance with what you have selected on the front panel GUI before pressing the **Sample** or **Continuous** buttons to acquire samples.
9. To show samples output by the EVAL-AD7764/5/EDZ evaluation board Click **Sample** or **Continuous**. Clicking **Sample** gives one set of samples, the length of which is determined by the **Number of Samples** selection on the software front panel. Clicking **Continuous** shows continuously updated samples of the analog input to the device.

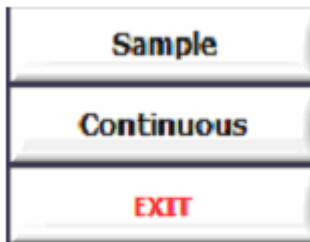

Figure 12. **Sample** and **Continuous** Front Panel Buttons

10. It is important to ensure that the frequency of the $\overline{\text{FSO}}$ pulse on an oscilloscope (at the test-point marked $\overline{\text{FSO}}$) is checked so that it matches the frequency shown in the **Frequency** text box on the software front panel.
11. If at any stage these do not match, reset the AD7764/AD7765/ evaluation board by pressing the **RESET** push button on the

evaluation board or using the **RESET** button on the software front panel. Then set the decimation rate on the software front panel to the correct default value.

12. The AD7764/5 software front panel also shows the status bits corresponding to the final sample in the batch of samples shown on the screen. The status indicator- marked “**ADC Status Bits**” correspond to the final 8 bits output in each conversion result, and indicate the power mode, over voltage inputs and Filter Settle information.
13. The AD7764/5 software also allows the user to program the Overrange and Gain correction registers. The write functions for these registers are located in the top right hand corner of the GUI. The default Gain of the AD7764/5 is set to 1.25. Changing this value allows the user to digitally alter the gain of the conversion result, as it is output from the AD7764/5 device.
14. Programming the Overrange register allow the user to set a threshold whereby any signal sampled which passes this threshold will set off a flag on the overrange bit and overrange register bit as detailed in the AD7764/5 datasheets.
15. Both of these registers can be read to verify the value written to the ADC. The Read function and indicator for each register are located directly below the write functions.

SOURCE FPGA AND LABVIEW CODE

The FPGA source code for the EVAL-AD7764/5EDZ system is available from the AD7764 and AD7765 product pages by clicking on the Evaluation tools link. This FPGA code can be used as example code for users wishing to build their own interface to the AD7764/5 devices. The source Labview code for the evaluation software is also available to users wishing to incorporate the AD7764/5 conversion outputs as acquired by the CED board into their own Labview analysis routines. Again, see the AD7764/5 product pages at www.analog.com for download.

EVALUATION BOARD SCHEMATIC AND ARTWORK

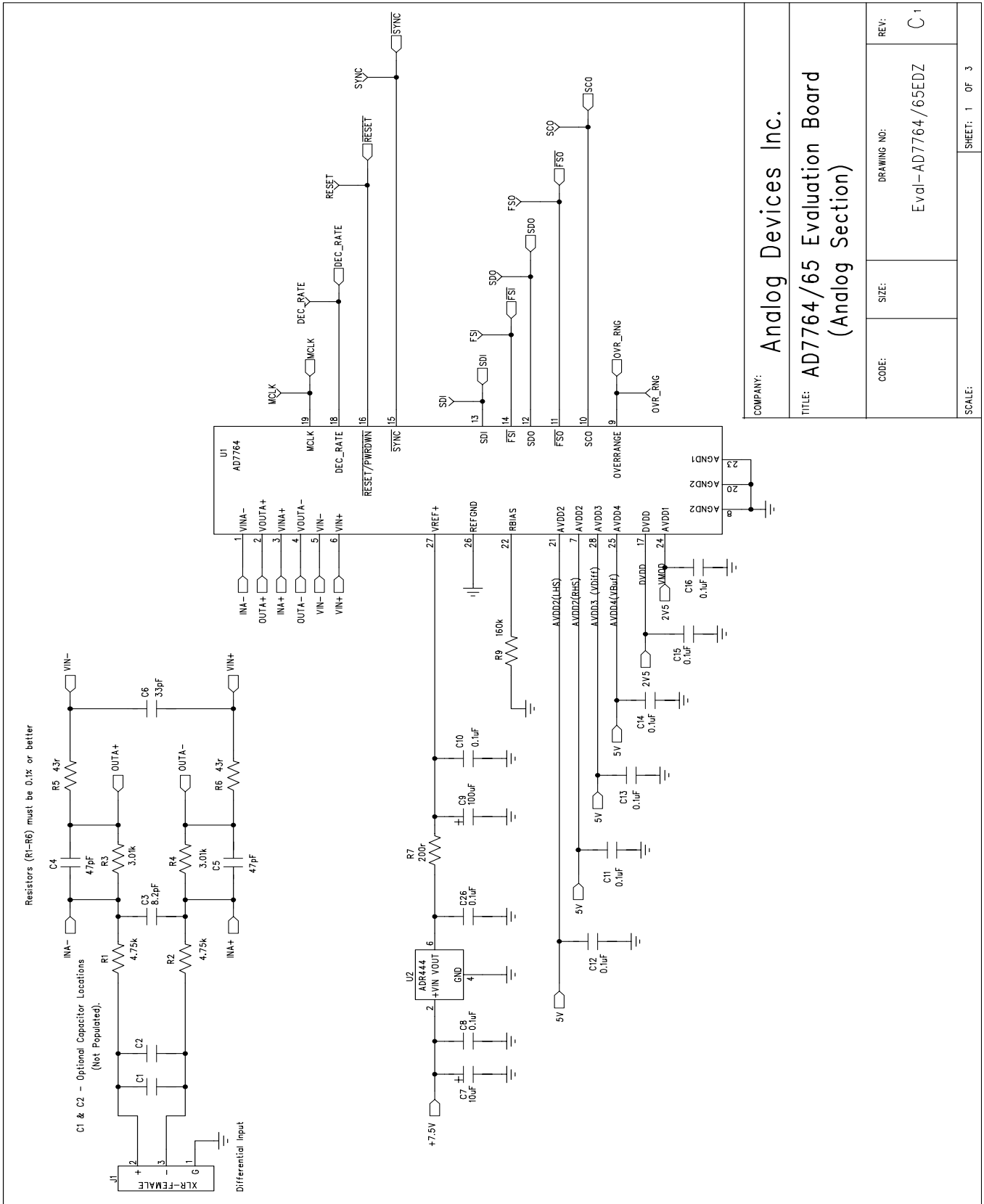

Figure 13. EVAL-AD7764/AD7765EDZ Schematic (Analog Section Rev.C1) Page 1 of 4

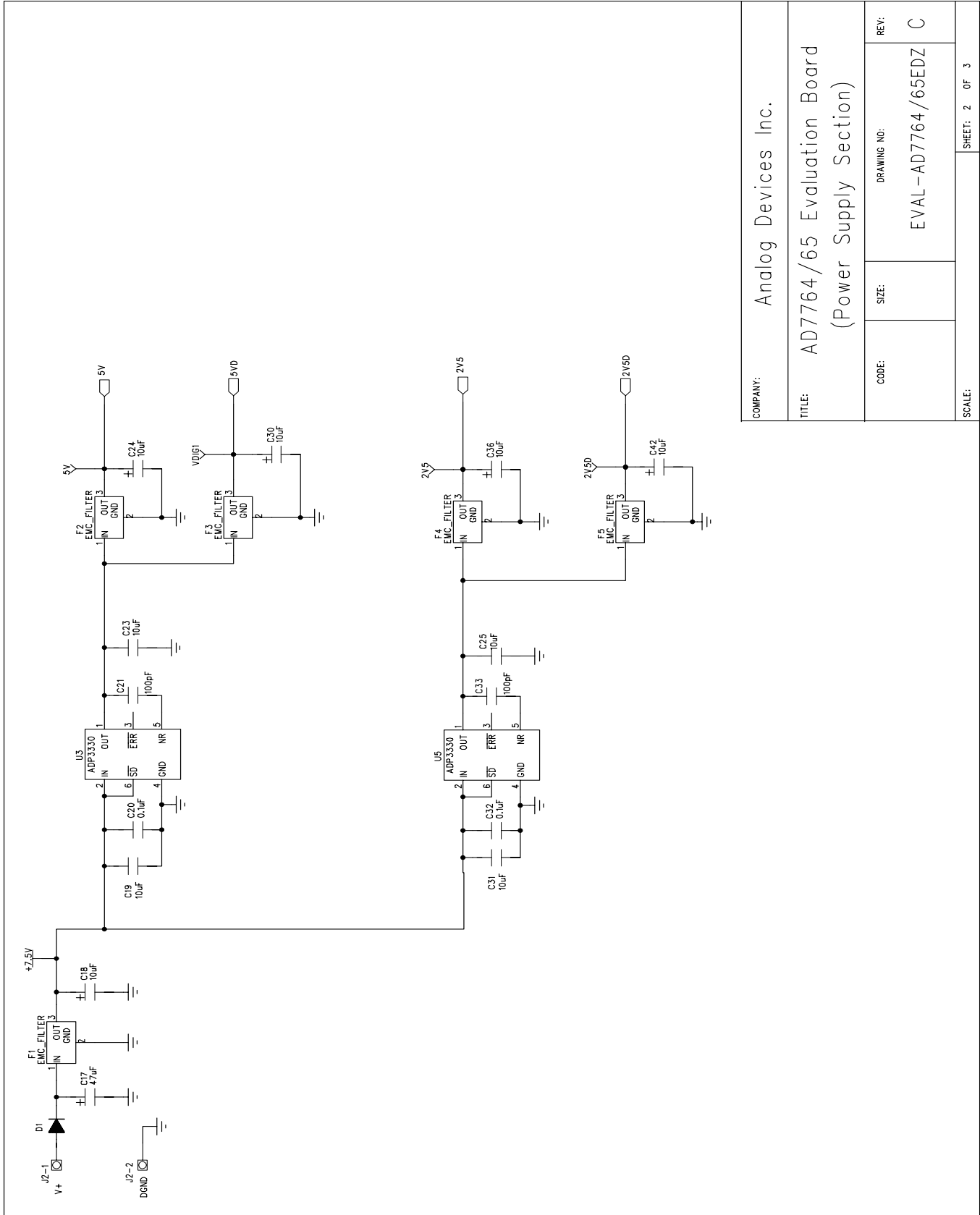

Figure 14. EVAL-AD7764/AD7765EDZ Schematic (Power Supply Section Rev C1) Page 2 of 3

COMPANY: Analog Devices Inc.		
TITLE: AD7764/65 Evaluation Board (Power Supply Section)		
CODE:	SIZE:	REV: C
DRAWING NO: EVAL-AD7764/65EDZ		SHEET: 2 OF 3
SCALE:		

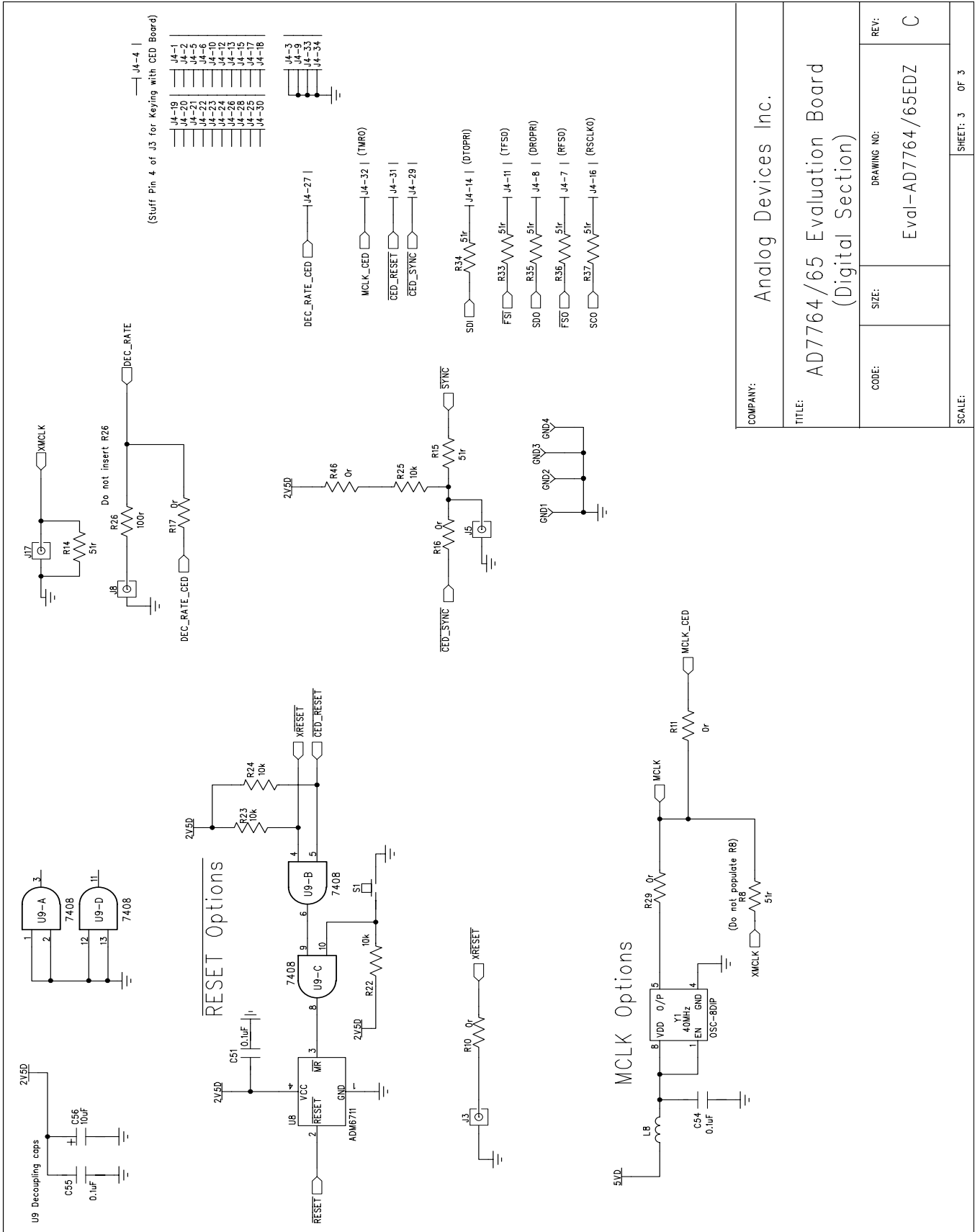
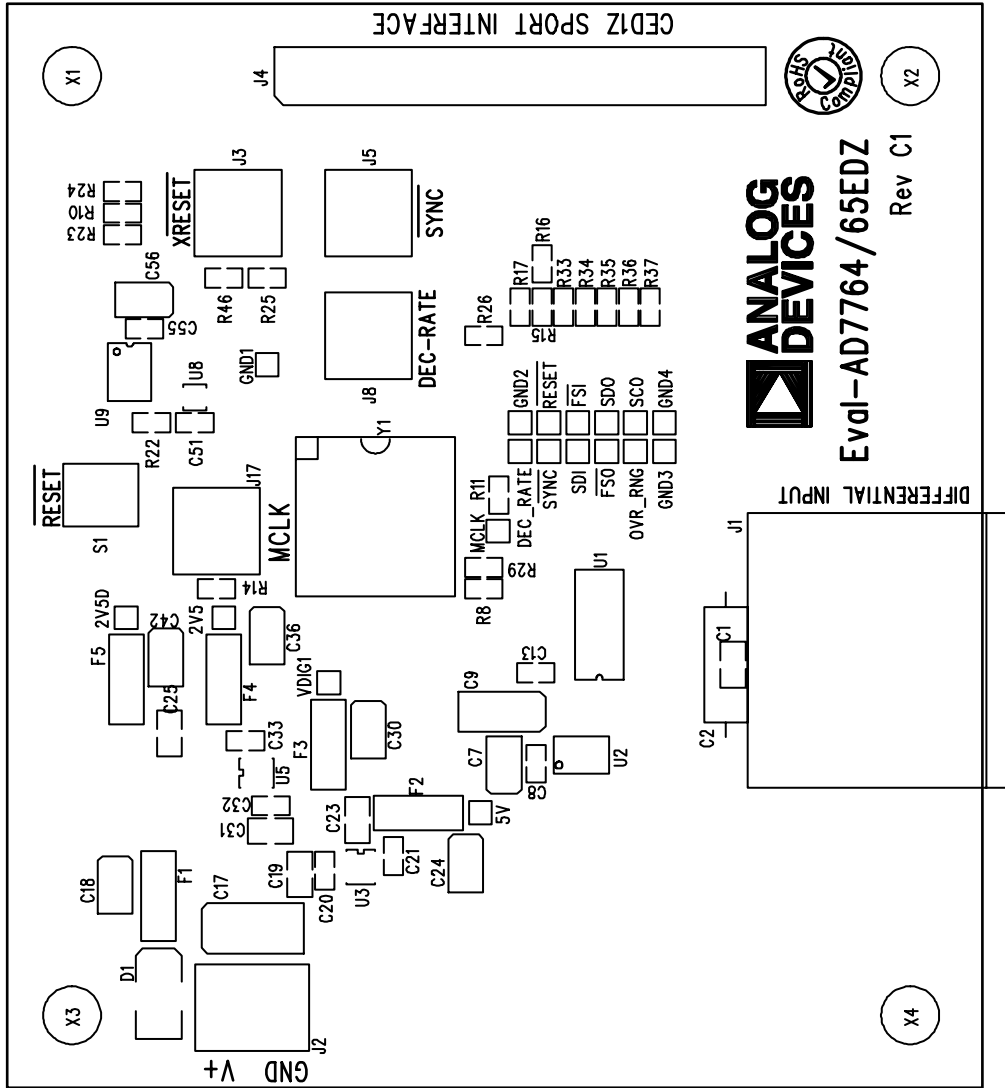

Figure 15. EVAL-AD7764/AD7765EDZ Schematic (Digital Section RevC1) Page 3 of 3

COMPANY:		Analog Devices Inc.	
TITLE:		AD7764/65 Evaluation Board (Digital Section)	
CODE:	SIZE:	DRAWING NO:	REV:
		Eval-AD7764/65EDZ	C
SCALE:		SHEET: 3 OF 3	



Eval-AD7764/65EDZ (Rev. C1) – Component Side View.
Silkscreen Top

Figure 16. EVAL-AD7764/AD7765EDZ Component Side Top Silkscreen Artwork

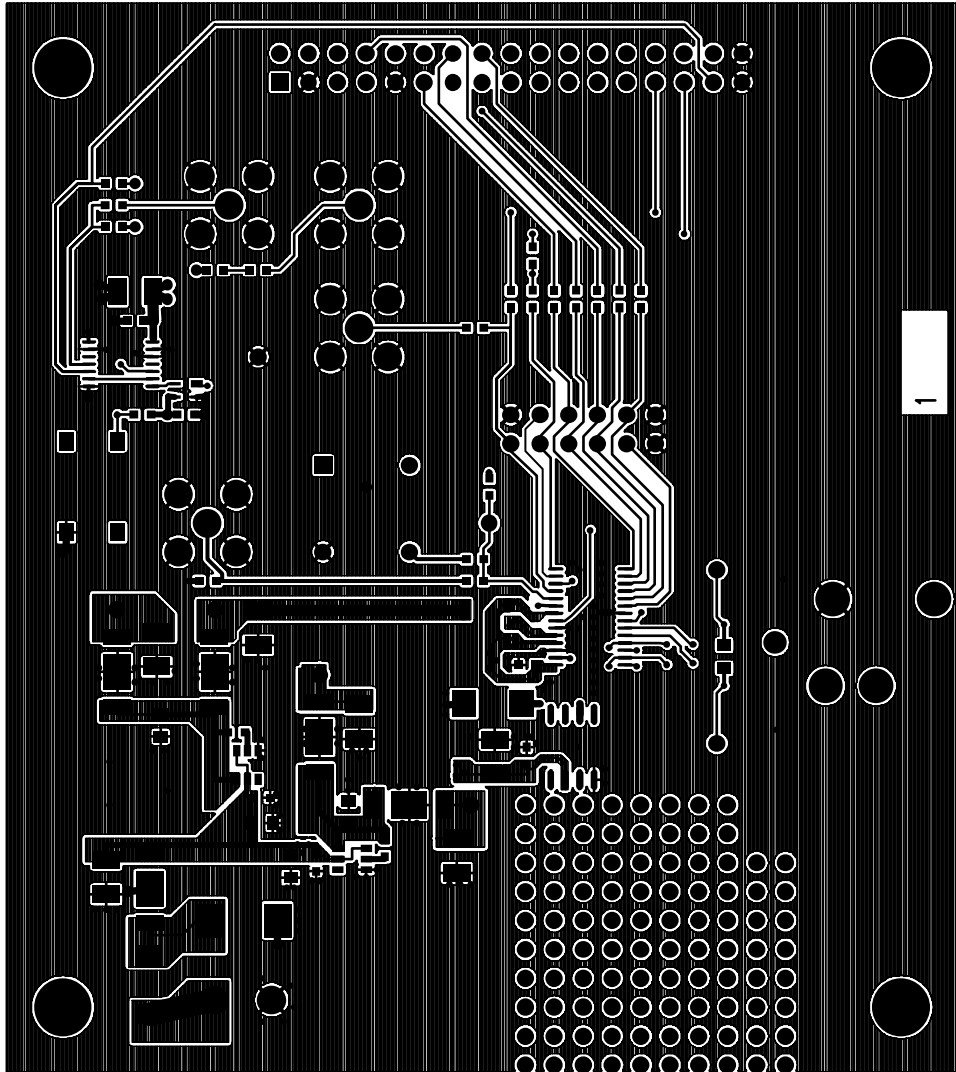

Eval-AD7764/65EDZ (Rev. C1) – Component Side View.
Component Side – Layer 1

Figure 17. EVAL-AD7764/AD7765EDZ Component Side Layer 1 Artwork

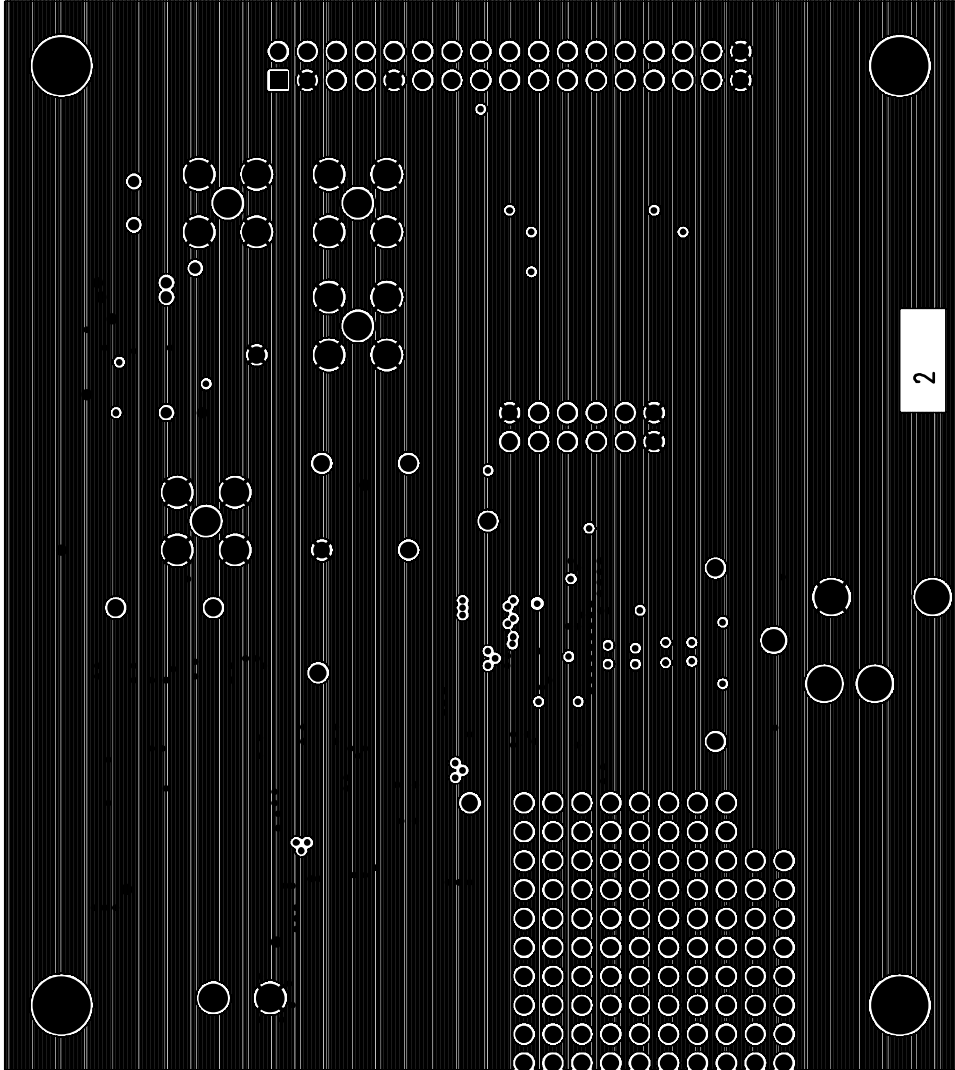

Eval-AD7764/65EDZ (Rev. C1) – Component Side View.

Ground Plane – Layer 2

Figure 18. EVAL-AD7764/AD7765EDZ Ground Plane Layer 2 Artwork

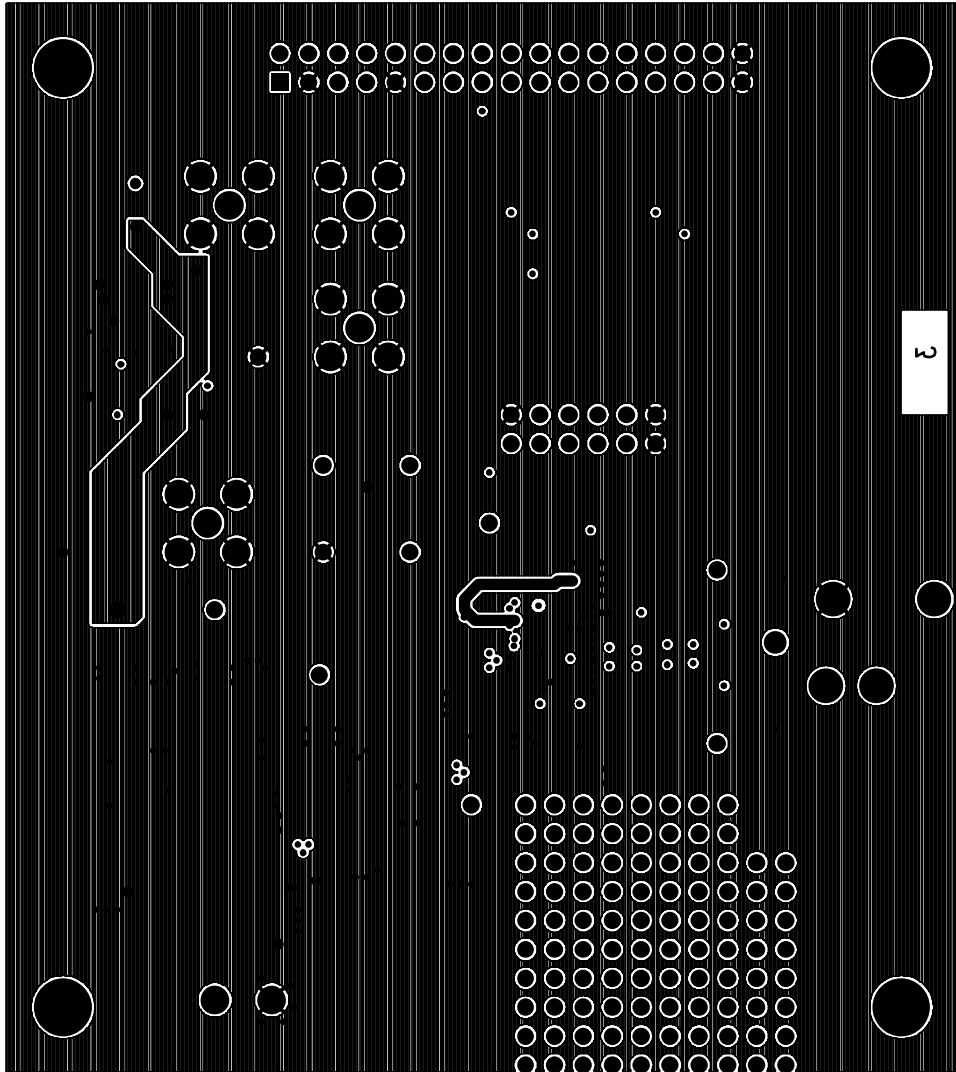

Eval-AD7764/65EDZ (Rev. C1) – Component Side View.

Power – Layer 3

Figure 19. EVAL-AD7764/AD7765EDZ Power Plane Layer 2 Artwork

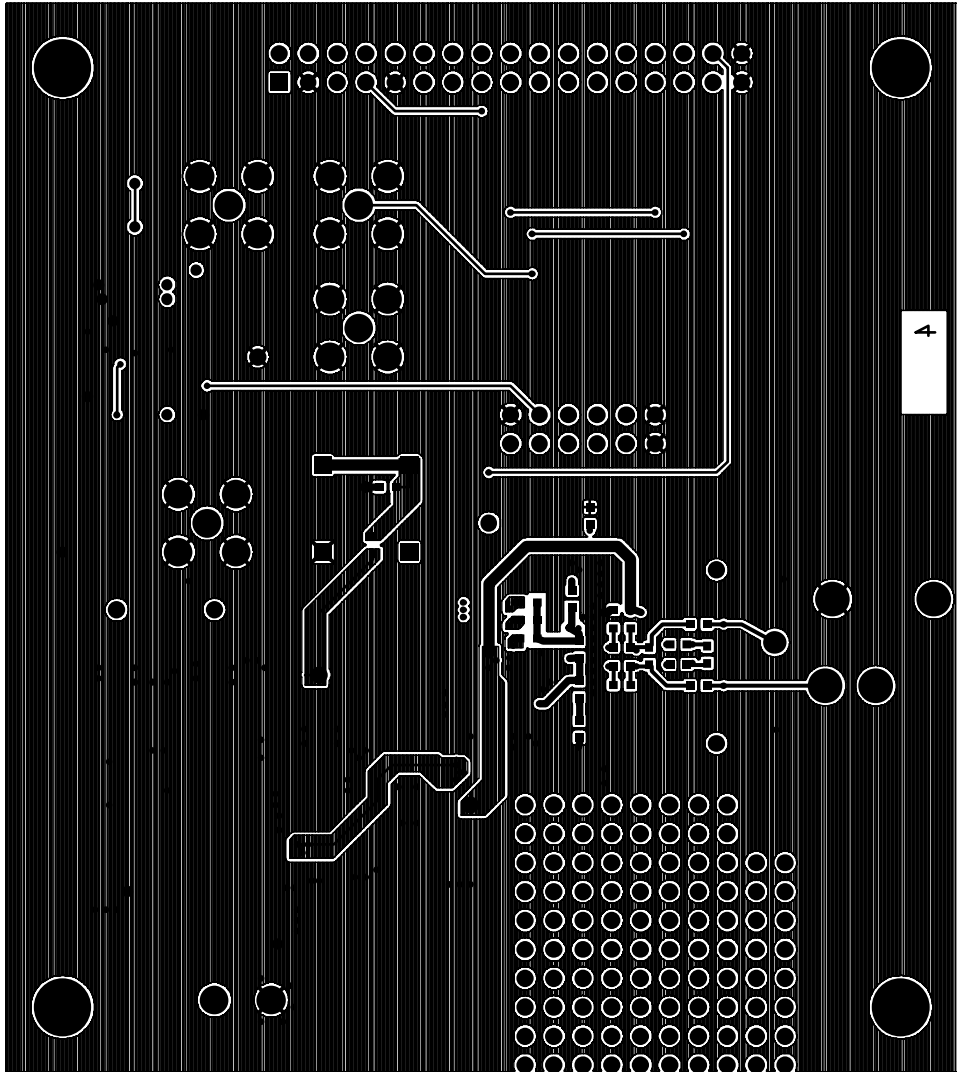

Eval-AD7764/65EDZ (Rev. C1) – Component Side View.

Solder Side – Layer 4

Figure 20. EVAL-AD7764/AD7765EDZ Solder Side Layer 4 Artwork

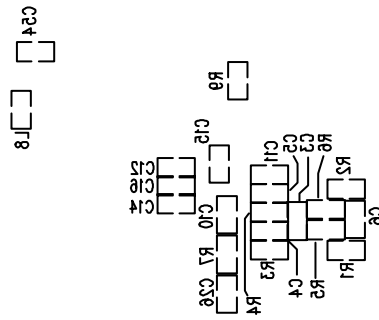

Eval-AD7764/65EDZ (Rev. C1) – Component Side View.

silkscreen Bottom

Figure 21. EVAL-AD7764/AD7765EDZ Component Side Bottom Silkscreen Artwork

ORDERING INFORMATION

BILL OF MATERIALS

Table 2. ¹

Ref	Part Type		Component Details	Supplier	Part Number	Order Code
C1	CAP	n/a	Optional Capacitor Footprint	Do not insert		
C2	CAP	n/a	Optional Capacitor Footprint	Do not insert		
C3	CAP 5%	8.2pF	50V NPO Multilayer Ceramic Capacitor	PHYCOMP	2238 867 15828	FEC 721-955
C4	CAP 5%	47pF	50V NPO Multilayer Ceramic Capacitor	AVX	06035A470JAT2A	FEC 498-567
C5	CAP 5%	47pF	50V NPO Multilayer Ceramic Capacitor	AVX	06035A470JAT2A	FEC 498-567
C6	CAP 5%	33pF	50V NPO Multilayer Ceramic Capacitor	AVX	06035A330JAT2A	FEC 498-555
C7	CAP+	10uF	20V Tantalum Capacitor	AVX	TAJB106K020R	FEC 197427
C8	CAP 5%	0.1uF	16V X7R Multilayer Ceramic Capacitor	Multicomp	B0603R104KCT	FEC 940-6140
C9	CAP+	100uF	10v Tantalum Capacitor	AVX	TAJC107K010R	FEC 197180
C10	CAP 10%	0.1uF	16V X7R Multilayer Ceramic Capacitor	Multicomp	B0603R104KCT	FEC 940-6140
C11	CAP 10%	0.1uF	16V X7R Multilayer Ceramic Capacitor	Multicomp	B0603R104KCT	FEC 940-6140
C12	CAP 10%	0.1uF	16V X7R Multilayer Ceramic Capacitor	Multicomp	B0603R104KCT	FEC 940-6140
C13	CAP 10%	0.1uF	16V X7R Multilayer Ceramic Capacitor	Multicomp	B0603R104KCT	FEC 940-6140
C14	CAP 10%	0.1uF	16V X7R Multilayer Ceramic Capacitor	Multicomp	B0603R104KCT	FEC 940-6140
C15	CAP 10%	0.1uF	16V X7R Multilayer Ceramic Capacitor	Multicomp	B0603R104KCT	FEC 940-6140
C16	CAP 10%	0.1uF	16V X7R Multilayer Ceramic Capacitor	Multicomp	B0603R104KCT	FEC 940-6140
C17	CAP 10%	47uF	20V Tantalum Capacitor	AVX	TAJD476K020R	FEC 197464
C18	CAP 10%	10uF	20V Tantalum Capacitor	AVX	TAJB106K020R	FEC 197427
C19		10uF	10V X5R 10% Ceramic Multi-Layer Capacitor	Phycomp	2222 2401 3676	FEC 9402136
C20	CAP 10%	0.1uF	16V X7R Multilayer Ceramic Capacitor	Multicomp	B0603R104KCT	FEC 940-6140
C21	CAP 5%	100pF	50V NPO Multilayer Ceramic Capacitor	Multicomp	U0603C101JCT	FEC 9406115
C23	CAP 10%	10uF	10V X5R 10% Ceramic Multi-Layer Capacitor	Phycomp	2222 2401 3676	FEC 9402136
C24	CAP+ 10%	10uF	20V Tantalum Capacitor	AVX	TAJB106K020R	FEC 197427
C25	CAP 10%	10uF	10V X5R 10% Ceramic Multi-Layer Capacitor	Phycomp	2222 2401 3676	FEC 9402136
C26	CAP 10%	0.1uF	16V X7R Multilayer Ceramic Capacitor	Multicomp	B0603R104KCT	FEC 940-6140
C30	CAP+ 10%	10uF	20V Tantalum Capacitor	AVX	TAJB106K020R	FEC 197427
C31	CAP 10%	10uF	10V X5R 10% Ceramic Multi-Layer Capacitor	Phycomp	2222 2401 3676	FEC 9402136
C32	CAP 10%	0.1uF	16V X7R Multilayer Ceramic Capacitor	Multicomp	B0603R104KCT	FEC 940-6140
C33	CAP 5%	100pF	50V NPO Multilayer Ceramic Capacitor	Multicomp	U0603C101JCT	FEC 9406115
C36	CAP+ 10%	10uF	20V Tantalum Capacitor	AVX	TAJB106K020R	FEC 197427
C42	CAP+ 10%	10uF	20V Tantalum Capacitor	AVX	TAJB106K020R	FEC 197427
C51	CAP 10%	0.1uF	16V X7R Multilayer Ceramic Capacitor	Multicomp	B0603R104KCT	FEC 940-6140
C54	CAP 10%	0.1uF	16V X7R Multilayer Ceramic Capacitor	Multicomp	B0603R104KCT	FEC 940-6140
C55	CAP 10%	0.1uF	16V X7R Multilayer Ceramic Capacitor	Multicomp	B0603R104KCT	FEC 940-6140
C56	CAP+ 10%	10uF	20V Tantalum Capacitor	AVX	TAJB106K020R	FEC 197427
D1	DIODE-S2M		2A Rectifier Diode	General Semicoductor	S2M	FEC 9843876
F1	EMC_FILTER	1nF	1nF 3-Terminal Capacitor	Murata	NFE61PT102E1H9L	FEC 9528202
F2	EMCFILTER	1nF	1nF 3-Terminal Capacitor	Murata	NFE61PT102E1H9L	FEC 9528202
F3	EMCFILTER	1nF	1nF 3-Terminal Capacitor	Murata	NFE61PT102E1H9L	FEC 9528202
F4	EMCFILTER	1nF	1nF 3-Terminal Capacitor	Murata	NFE61PT102E1H9L	FEC 9528202
F5	EMCFILTER	1nF	1nF 3-Terminal Capacitor	Murata	NFE61PT102E1H9L	FEC 9528202
J1	XLR-FEMALE		XLR Female Audio Connector	Neutrik AG	NC3FAH1-1	FEC 724518

Preliminary Technical Data

EVAL-AD7764/AD7765EDZ

Ref	Part Type		Component Details	Supplier	Part Number	Order Code
J2	CON/POW ER		2 Pin Terminal Block (5mm Pitch)	Camden	CTB5000/2	FEC 151789
J3	SMB		50 Ohm SMB Jack	Do not insert		FEC 4194512
J4	HEADER34		34-Pin 0.1" Pitch DIL Vertical Tail Socket Assembly, tin, 17+17-way	Harwin	M20-7831746	Mouser 855- M20-7831746
J5	SMB		50 Ohm SMB Jack	Do not insert		FEC 4194512
J8	SMB		50 Ohm SMB Jack	Do not insert		FEC 4194512
J17	SMB		50 Ohm SMB Jack	Do not insert		FEC 4194512
L8	IND	200uH	Inductor	Würth Elektronik	74279266LF	tba Digikey RR08P4.75KBCT- ND
R1	RES 0.10%	4.75k	Precision SMD Resistor	Susumu Co Ltd	RR0816P-4751-B-T5-66H	Digikey RR08P4.75KBCT- ND
R2	RES 0.10%	4.75k	Precision SMD Resistor	Susumu Co Ltd	RR0816P-4751-B-T5-66H	ND
R3	RES 0.10%	3.01k	Precision SMD Resistor	Welwyn	PCF0603R 3K01BLT1	FEC 1160337
R4	RES 0.10%	3.01k	Precision SMD Resistor	Welwyn	PCF0603R 3K01BLT1	FEC 1160337
R5	RES 0.10%	43r	Precision SMD Resistor	Holsworthy (Tyco)	RN73C1J43R2BTG	FEC 1140687
R6	RES 0.10%	43r	Precision SMD Resistor	Holsworthy (Tyco)	RN73C1J43R2BTG	FEC 1140687
R7	RES 1%	200r	SMD Resistor	Multicomp	MC 0.063W 0603 1% 200R	FEC 9330755
R8	RES 1%	51r	SMD Resistor	Multicomp	MC 0.063W 0603 51R	FEC 9331336
R9	RES 1%	160k	SMD Resistor	Multicomp	MC 0.063W 0603 1% 160K	FEC 9330682
R10	RES 1%	0r	SMD Resistor	Multicomp	MC 0.063W 0603 0R	FEC 9331662
R11	RES 1%	0r	SMD Resistor	Multicomp	MC 0.063W 0603 0R	FEC 9331662
R14	RES 1%	51r	SMD Resistor	Multicomp	MC 0.063W 0603 51R	FEC 9331336
R15	RES 1%	51r	SMD Resistor	Multicomp	MC 0.063W 0603 51R	FEC 9331336
R16	RES 1%	0r	SMD Resistor	Do not insert	n/a	n/a
R17	RES 1%	0r	SMD Resistor	Multicomp	MC 0.063W 0603 0R	FEC 9331662
R22	RES 1%	10k	SMD Resistor	Multicomp	MC 0.063W 0603 10K	FEC 933-0399
R23	RES 1%	10k	SMD Resistor	Multicomp	MC 0.063W 0603 10K	FEC 933-0399
R24	RES 1%	10k	SMD Resistor	Multicomp	MC 0.063W 0603 10K	FEC 933-0399
R25	RES 1%	10k	SMD Resistor	Multicomp	MC 0.063W 0603 10K	FEC 933-0399
R26	RES 1%	100r	SMD Resistor	Do not insert	n/a	n/a
R29	RES 1%	0r	SMD Resistor	Multicomp	MC 0.063W 0603 0R	FEC 9331662
R33	RES 1%	0r	SMD Resistor	Multicomp	MC 0.063W 0603 0R	FEC 9331662
R34	RES 1%	0r	SMD Resistor	Multicomp	MC 0.063W 0603 0R	FEC 9331662
R35	RES 1%	0r	SMD Resistor	Multicomp	MC 0.063W 0603 0R	FEC 9331662
R36	RES 1%	0r	SMD Resistor	Multicomp	MC 0.063W 0603 0R	FEC 9331662
R37	RES 1%	0r	SMD Resistor	Multicomp	MC 0.063W 0603 0R	FEC 9331662
R46	RES 1%	0r	SMD Resistor	Multicomp	MC 0.063W 0603 0R	FEC 9331662
S1	SW-PUSH- SMD		SMD Push Button Switch (sealed 6mm x 6mm)	Omron	B3S-1000	FEC 177-807
U1	AD7764		24-bit Serial ADC	Analog Devices	AD7764/65BRUZ	AD7764/65BRUZ
U2	ADR444		Voltage Reference	Analog Devices	ADR444ARZ	ADR444ARZ
U3	ADP3330		Low Dropout Regulator	Analog Devices	Code on device to read L8B	ADP3330ARTZ-5
U5	ADP3330		Low Dropout Regulator	Analog Devices	Code on device to read L1B	ADP3330ARTZ- 2.5
U8	ADM6711		Reset Generator	Analog Devices	ADM6711ZAKSZ	ADM6711ZAKSZ
U9	7408		Quad 2-Input AND Gate		SN74LVC08APWR	FEC 1102978
Y1	OSC-8DIP	40MHz	Osc Clock 40MHZ CMOS/TTL 1/2Size	CTS Corp	MX045HS40M0000	Digikey CTX175- ND

¹FEC as listed in Table 2 corresponds to the order code for the component on Farnell.

ORDERING GUIDE

Model	Description
EVAL-AD7764EDZ	AD7764 Evaluation Kit
EVAL-AD7765EDZ	AD7765 Evaluation Kit
EVAL-CED1Z	Converter Evaluation and Development (CED) Board

ESD CAUTION

ESD (electrostatic discharge) sensitive device. Charged devices and circuit boards can discharge without detection. Although this product features patented or proprietary protection circuitry, damage may occur on devices subjected to high energy ESD. Therefore, proper ESD precautions should be taken to avoid performance degradation or loss of functionality.

NOTES