

# NCP1602GEVB

## 160-W, Wide Mains, PFC Stage Driven by the NCP1602 Evaluation Board User's Manual



ON Semiconductor®

[www.onsemi.com](http://www.onsemi.com)

### EVAL BOARD USER'S MANUAL

#### Introduction

Housed in a TSOP6 package, the NCP1602 is designed to drive PFC boost stages in so-called Valley Synchronized Frequency Fold-back (VSFF). In this mode, the circuit classically operates in Critical conduction Mode (CrM) when VCTRL pin voltage exceeds a product version programmable voltage level. When VCTRL pin voltage is below this programmable level, the NCP1602 linearly decays the frequency down to about 20 kHz, when the load current is nearly zero. VSFF maximizes the efficiency throughout the load range. Incorporating protection features for rugged operation, it is furthermore ideal in systems where cost-effectiveness, reliability, low stand-by power

and high-efficiency are the key requirements. Extremely slim, the NCP1602 evaluation board is designed to be less than 13 mm high. This low-profile PFC Stage is intended to deliver 160 W under a 390-V output voltage from a wide mains input. This is a PFC boost converter as used in flat TVs, high power LED street light power supplies, and all-in-one computer supplies. The evaluation board embeds the NCP1602 AEA-version which is powered by an external V<sub>CC</sub>. With the help of an external dc source, apply a V<sub>CC</sub> voltage that exceeds the NCP1602-AEA start-up level (18.2 V max) to ensure the circuit starts operating. The V<sub>CC</sub> operating range is from 9.5 V up to 30 V.

**Table 1. ELECTRICAL SPECIFICATIONS**

Description	Value	Units
Input Voltage Range	90–265	V rms
Line Frequency Range	45 to 66	Hz
Maximum Output Power	160	W
Minimum Output Load Current(s)	0	A
Number of Outputs	1	
Nominal Output Voltage	390	V
Maximum Start-Up Time	< 3	s
No-Load Power (115 V rms)	< 250	mW
Target Efficiency at Full Load (115 V rms)	95	%
Load Conditions for Efficiency Measurements (10%, 20%, ...)	10–100	%
Minimum Efficiency at 20% Load, 115 V rms	93	%
Minimum PF over the Line Range at Full Load	95	%
Hold-Up Time (the Output Voltage Remaining above 300 V)	> 10	ms
Peak to Peak Low Frequency Output Ripple	< 8	%

Product parametric performance is indicated in the Electrical Characteristics for the listed test conditions, unless otherwise noted. Product performance may not be indicated by the Electrical Characteristics if operated under different conditions.

# NCP1602GEVB

## THE BOARD

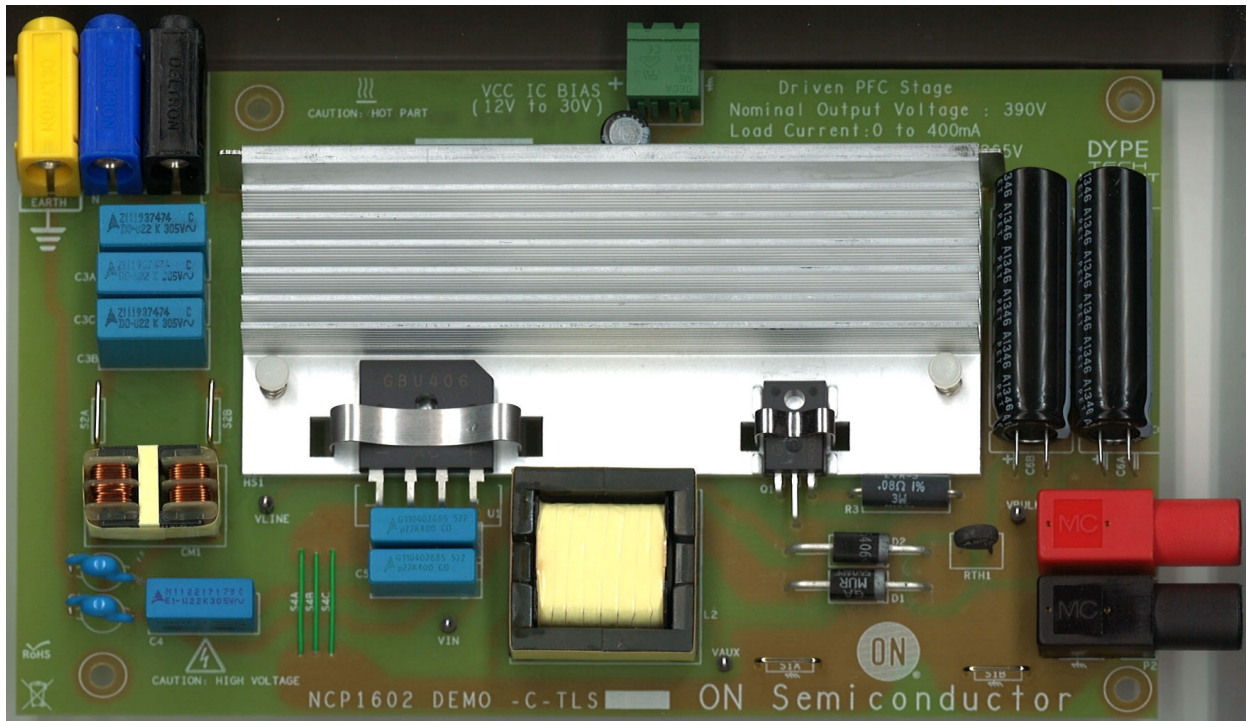

Figure 1. A Slim Board (Height < 13 mm)

# NCP1602GEVB

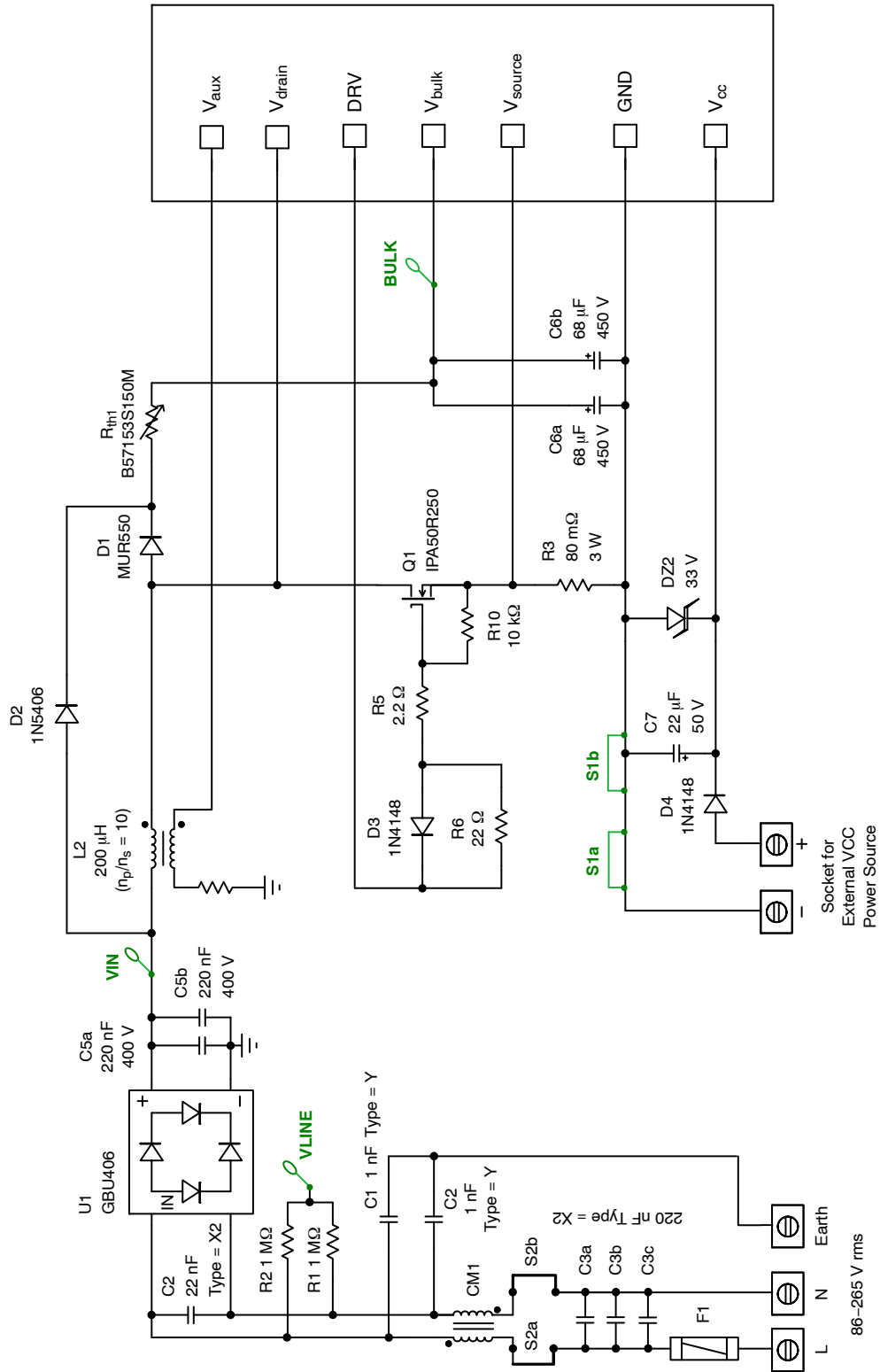

Figure 2. Application Schematic – Power Section

# NCP1602GEVB

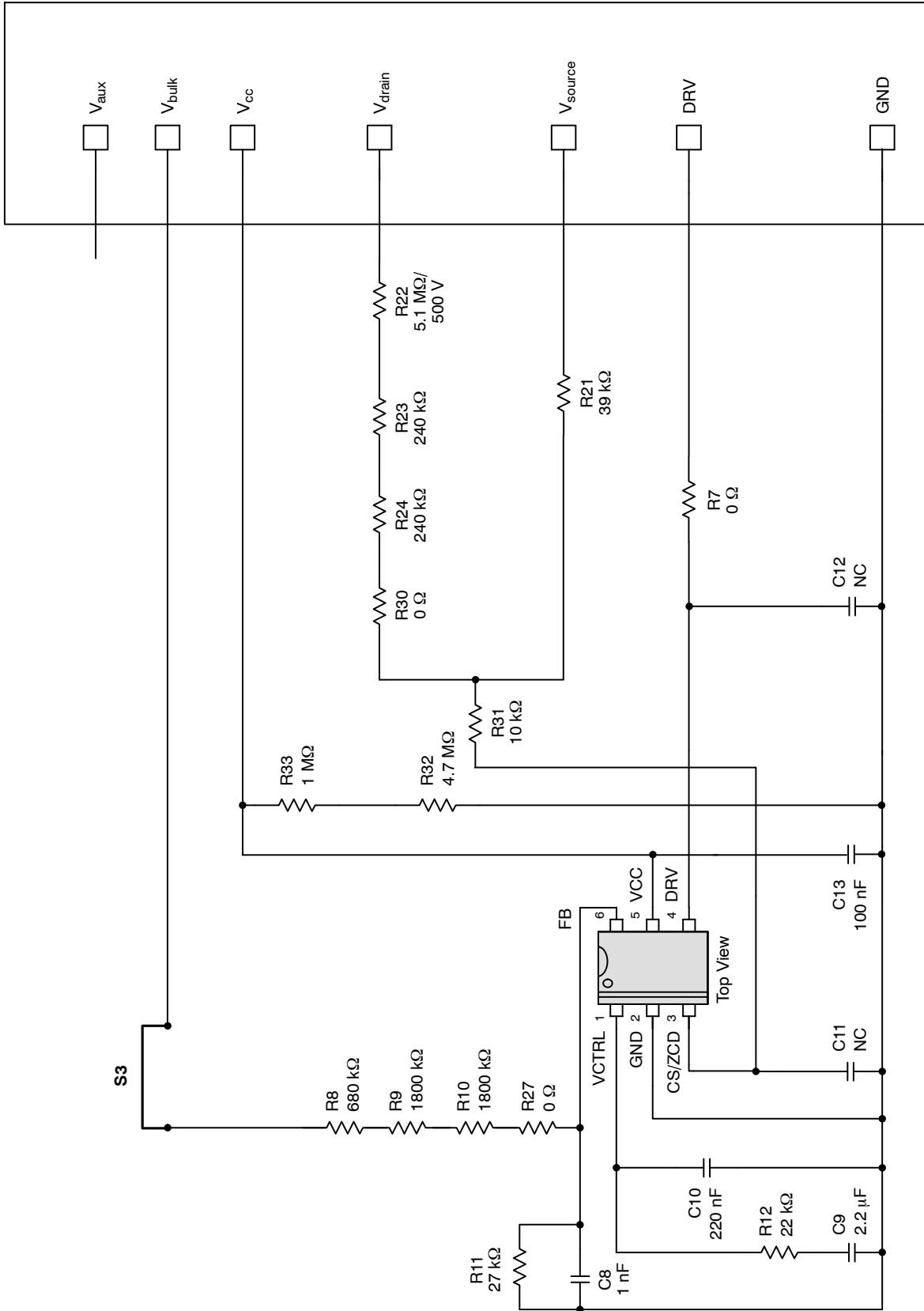

Figure 3. Application Schematic – Control Section

VSFF OPERATION

The NCP1602 operates in so called Valley Synchronized Frequency Fold-back (VSFF) where the circuit works in Critical conduction Mode (CrM) when the load current is medium to high ( $V_{CTRL}$  pin voltage medium or high). The load current is correlated with the  $V_{CTRL}$  pin voltage (see Table 2).  $V_{CTRL} = 4.5\text{ V}$  corresponds to the maximum current capability which in our case is not reached because we limit the application to 160 W and 0.5 V corresponds to zero load current. When  $V_{CTRL}$  pin voltage is lower than a preset level, the switching frequency linearly decays to about 20 kHz. VSFF maximizes the efficiency at both nominal and light loads. In particular, stand-by losses are minimized. When  $V_{CTRL}$  pin voltage ( $V_{CTRL}$ ) exceeds  $V_{CTRL,DT}$  voltage ( $V_{CTRL,DT} = 1.553\text{ V}$  for the AEA option), the circuit operates in CrM (typical CrM waveforms are depicted in Figure 4). If  $V_{CTRL}$  is below  $V_{CTRL,DT}$ , the circuit forces a delay (or dead-time) before re-starting a DRV cycle which is proportional to the difference between  $V_{CTRL,DT}$  reference and  $V_{CTRL}$  voltage. This mode is called discontinuous conduction mode (DCM) or Frequency Foldback and the main waveforms are depicted in Figure 5. This delay is maximum when  $V_{CTRL}$  reached is 0.5-V minimum value. When the 0.5-V  $V_{CTRL}$  minimum value is

reached, the circuit works in a so-called Static OVP mode (for no SKIP mode options like AEA option used on this board), by skipping cycles based on the difference voltage between  $V_{CTRL}$  and 0.5-V. This static OVP mode offers a very low output ripple voltage, unlike the classical SKIP mode of other options. The added dead time starts at the end of the boost inductor demagnetization cycle and ends at the on-time start which is synchronized with the boost inductor zero crossing (valley turn on) event.

In all cases, the circuit turns on in a drain-source voltage valley:

- Classical Valley Turn On in CrM Operation
- At the First Valley Following the Completion of the Dead-Time Generated by the VSFF Function to Reduce the Frequency

One can also note that the switching frequency being less when the load current is low, the frequency is particularly low at light load, high line. On the other hand, CrM operation being more likely to occur at heavy load, low line.

Refer to the data sheet for a detailed explanation of the VSFF operation and of its implementation in the NCP1602 [2].

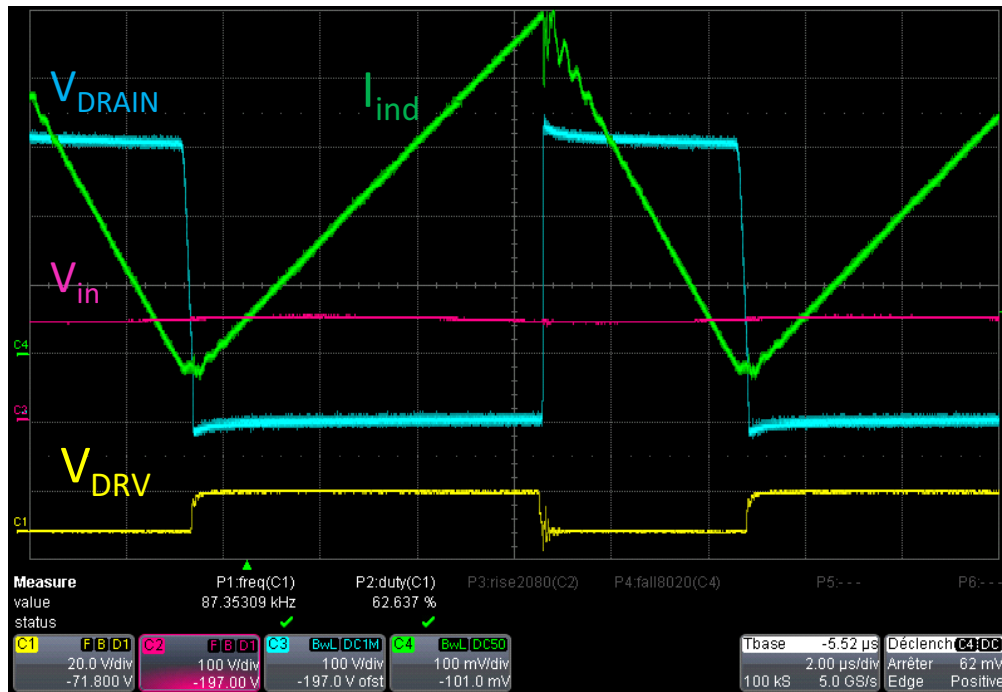

Figure 4. Typical Waveform in CrM @  $V_{MAINS} = 110\text{ V rms}$ ,  $F_{MAINS} = 60\text{ Hz}$ ,  $I_{LOAD} = 400\text{ mA}$

# NCP1602GEVB

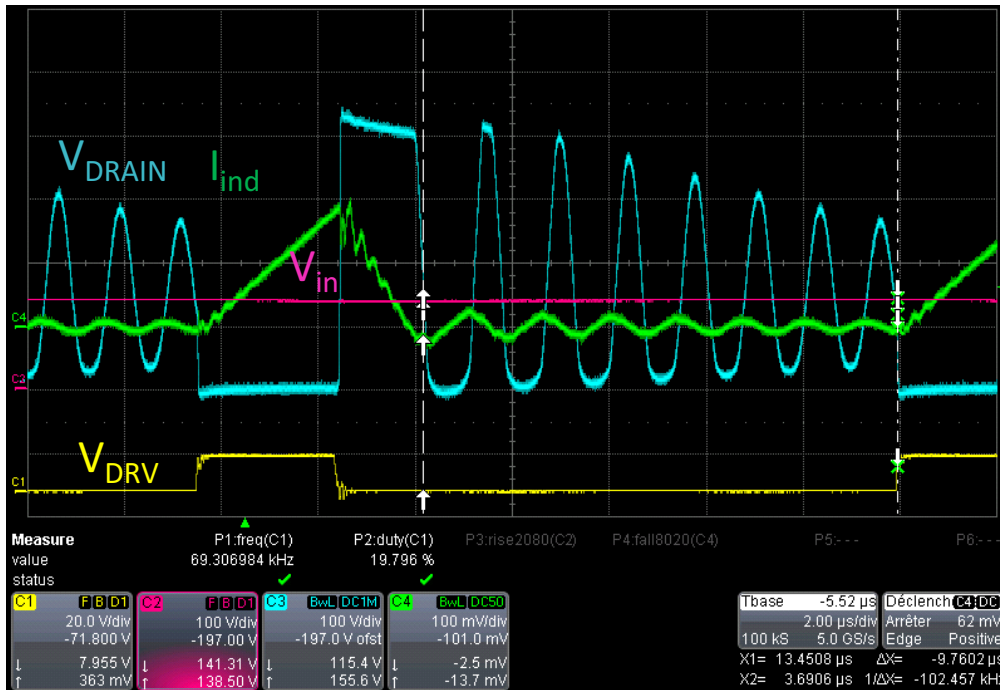

Figure 5. Typical Waveform in DCM @  $V_{MAINS} = 110$  V rms,  $F_{MAINS} = 60$  Hz,  $I_{LOAD} = 50$  mA

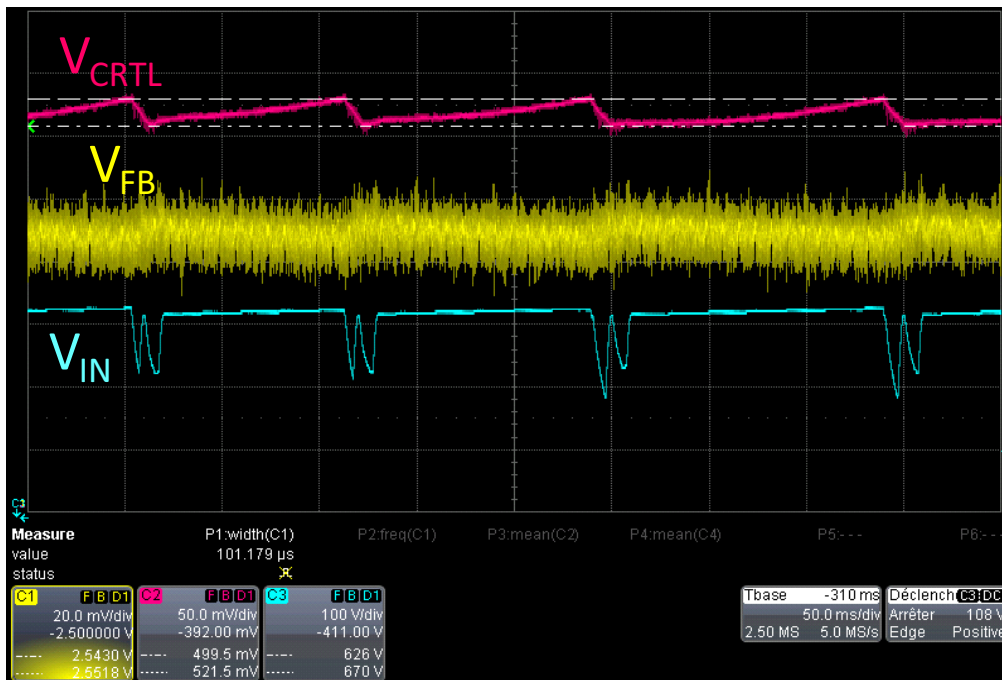

Figure 6. No-Load Waveforms for Option AEA (Skip Mode Disabled) Featuring Static OVP @  $V_{MAINS} = 230$  V rms

# NCP1602GEVB

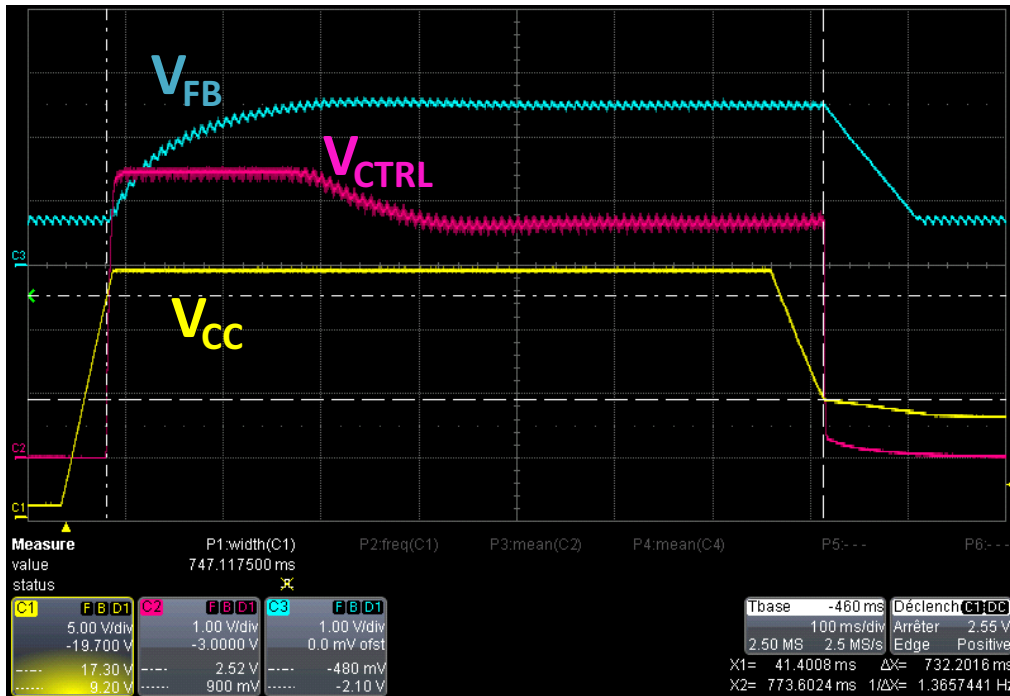

Figure 7. Start-Up and Stop Sequence @  $V_{MAINS} = 90\text{ V rms}$ ,  $I_{LOAD} = 400\text{ mA}$ ,  $V_{CC}$  OFF  $\Rightarrow$  ON  $\Rightarrow$  OFF

Table 2.  $V_{CTRL}$  VOLTAGE VS.  $I_{LOAD}$  &  $V_{MAINS}$

$V_{MAINS}$ (V rms)	@ $I_{LOAD} = 400\text{ mA}$	@ $I_{LOAD} = 300\text{ mA}$	@ $I_{LOAD} = 100\text{ mA}$	@ $I_{LOAD} = 50\text{ mA}$	@ $I_{LOAD} = 0\text{ mA}$
90	3.77	3.01	1.38	0.96	0.490
110	2.55	2.13	1.02	0.75	0.490
230	1.77	1.42	0.79	0.63	0.490
265	1.35	1.10	0.67	0.57	0.490

# NCP1602GEVB

## POWER FACTOR AND EFFICIENCY

The NCP1602 evaluation board embeds a NTC to limit the in-rush current that takes place when the PFC stage is plugged in. The NTC is placed in series with the boost diode. This location is rather optimum in term of efficiency since it is in the in-rush current path at a place where the rms

current is less compared to the input side. However, this component still consumes some power. That is why the efficiency is given with a shorted NTC to approximately improve the power efficiency value by 1 percent.

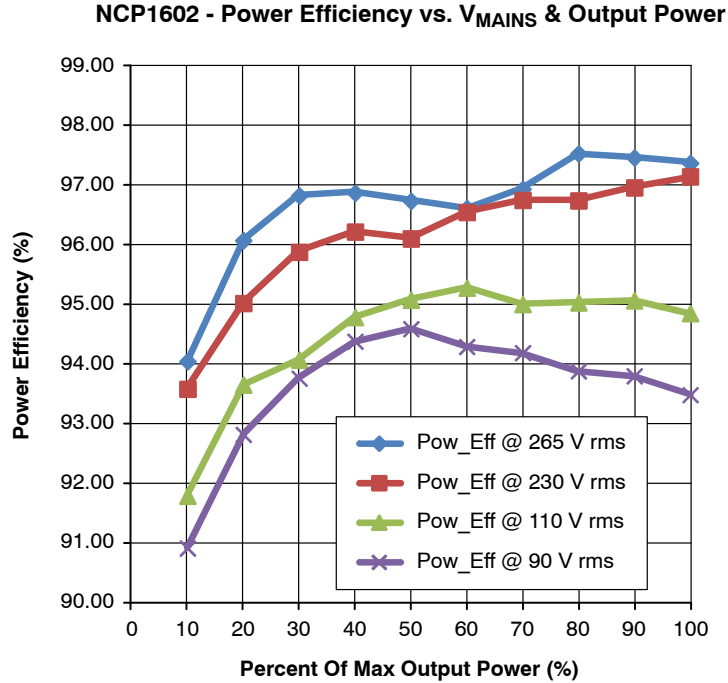

**Figure 8. Evaluation Board Power Efficiency vs. Output Power (NTC is Shorted)  
(100% Output Power Corresponds to 160 W)**

Figure 8 displays the efficiency versus load at different line levels. When considering efficiency versus load, we generally think of the traditional bell-shaped curves:

- At low line, the efficiency peaks somewhere at a medium load and declines at full load as a result of the conduction losses and at light load due to the switching losses
- At high line, the conduction losses being less critical, efficiency is maximal at or near the maximum load point and decays when the power demand diminishes because the increasing impact of the switching losses

Curves of Figure 8 meet this behavior in the right-hand side where our demo-board resembles a traditional CrM PFC stage. In the left-hand side, the efficiency normally drops because of the switching losses until an inflection point where it rises up again as a result of the VSFF

operation. As previously stated, VSFF makes the switching frequency decay linearly as a function of  $V_{CTRL}$  voltage (load current) when it goes below a preset level.

### PF and THD Performance Were Measured by Means of a CHROMA 66202 Digital Power Meter

Figure 9 and Figure 10 show that VSFF exhibits very similar PF ratios compared to those obtained with CrM traditional operation. VSFF improves the THD performance at light load. We can see on Figure 10 a 5% decrease of THD value when switching from CrM mode to DCM mode. This behavior is due to the fact that in CrM, close to mains voltage zero crossing, there is a zone of zero mains current which leads to a slight mains current distortion (higher THD). When entering DCM, as a dead time is added, the inductor peak current gets higher and the zero mains current region becomes narrower, leading to a 5% decrease of the THD value.



# NCP1602GEVB

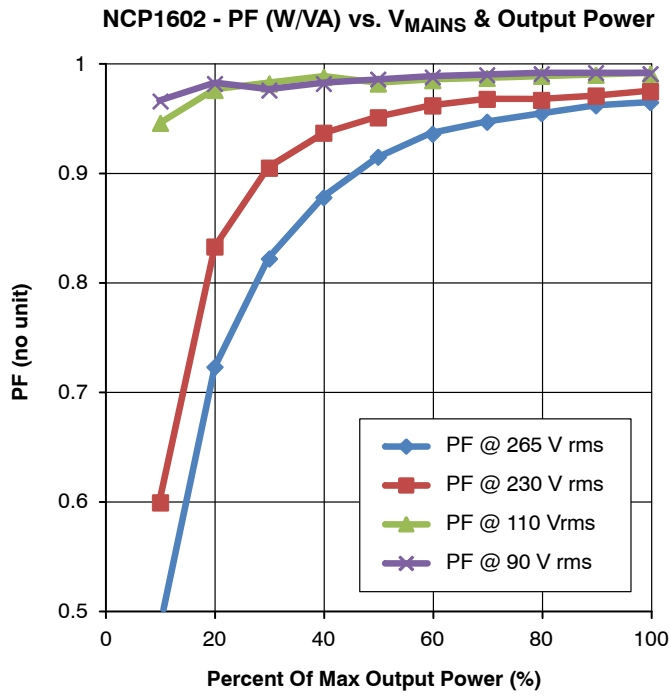

**Figure 9. Evaluation Board PF vs. Output Power (100% Output Power Corresponds to 160 W)**

**NCP1602 - Total Harmonic Distortion vs.  $V_{MAINS}$  & Output Power**

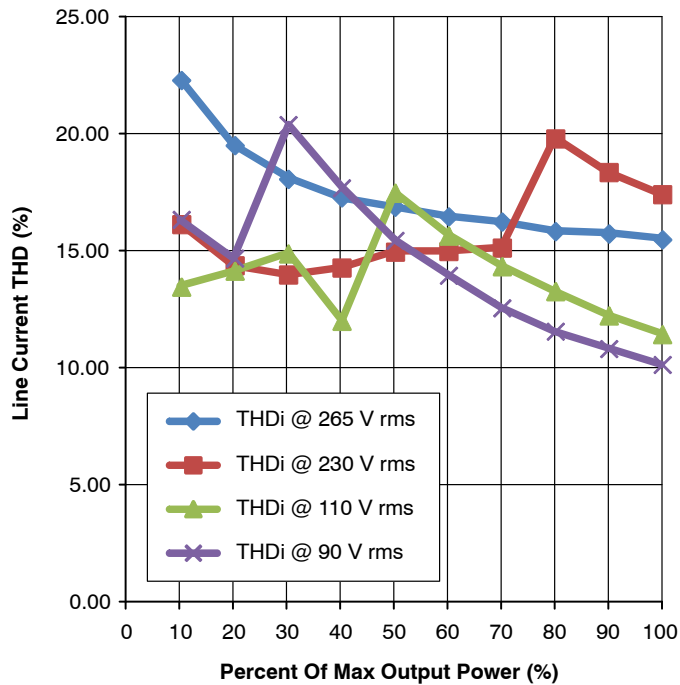

**Figure 10. Evaluation Board THD vs. Output Power (100% Output Power Corresponds to 160 W)**

## PROTECTION OF THE STAGES

The NCP1602 protection features allow for the design of very rugged PFC stages

### Brown-Out

Brown out detection is disabled in product option AEA which is used in this Evaluation Board. If brown-is needed, check which option is needed using the product data sheet [2] and use the application note [1] for operating details.

### Over-Current Protection (OCP)

The NCP1602 is designed to monitor the current flowing through the power switch. A current sense resistor (R3 of Figure 2) is inserted between the MOSFET source and ground to generate a positive voltage proportional to the

MOSFET current ( $V_{CSZCD}$ ). When  $V_{CSZCD}$  exceeds a 500-mV internal reference, the circuit forces the driver low. A 400-ns blanking time prevents the OCP comparator from tripping because of the switching spikes that occur when the MOSFET turns on. In our application, the theoretical maximal inductor current is:

$$I_{ind,max} = \left( \frac{500 \text{ mV}}{80 \text{ m}\Omega} \right) \approx 6.25 \text{ A} \quad (\text{eq. 1})$$

Figure 11 shows the inductor current when clamped. The over-current situation was obtained @  $V_{MAINS} = 90 \text{ V rms}$  with a 427-mA load. A 20-V  $V_{CC}$  power source was applied to the board.

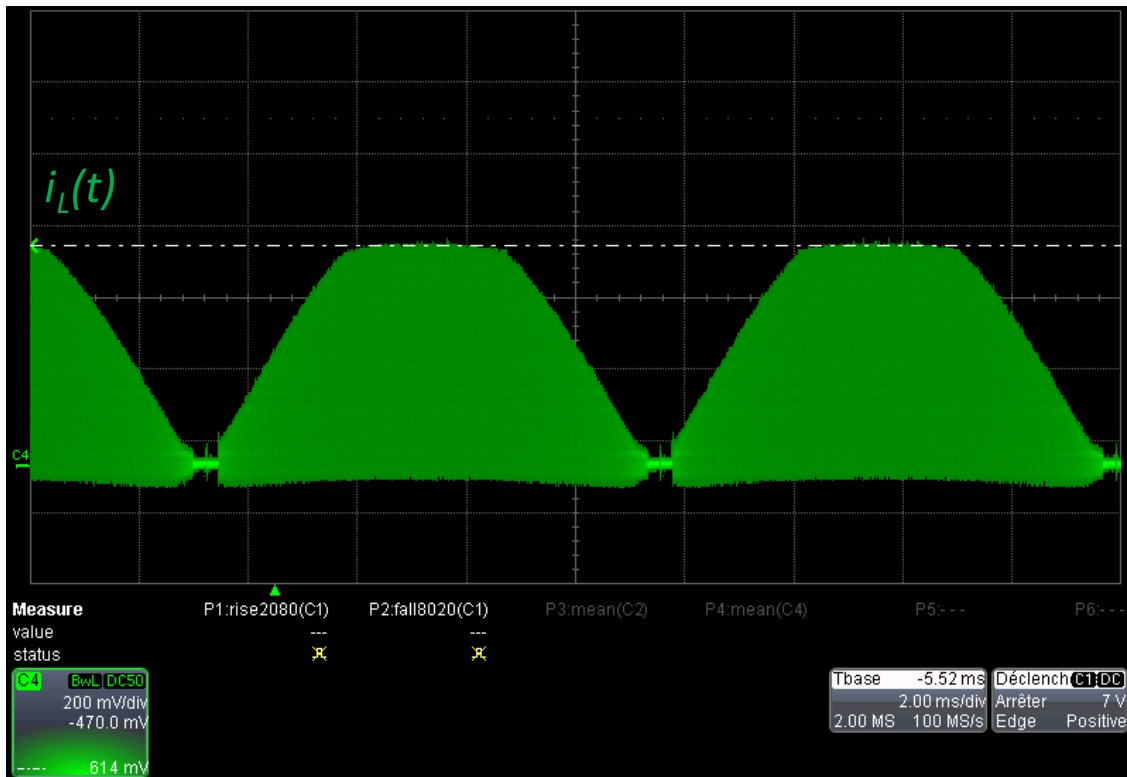

Figure 11. Inductor Current Showing OCP Limitation @  $V_{MAINS} = 90 \text{ V rms}$ ,  $F_{MAINS} = 60 \text{ Hz}$ ,  $I_{LOAD} = 427 \text{ mA}$

# NCP1602GEVB

## DYNAMIC PERFORMANCE

The NCP1602 features the **dynamic response enhancer (DRE)** that increases the loop gain by an order of magnitude when the output voltage goes below 95.5% of its nominal level. This function dramatically reduces undershoots in case of an abrupt increase of the load demand. As an example, Figure 12 illustrates a load step from 400 mA to

0 mA and 0 mA to 400 mA (2-A/ms slope) @ 110 V rms input voltage. One can note that as a result of the DRE function, the control signal ( $V_{CTRL}$ ) steeply rises multiple times when the FB voltage goes below  $0.955 \cdot 2.5 \text{ V} = 2.487 \text{ V}$ .

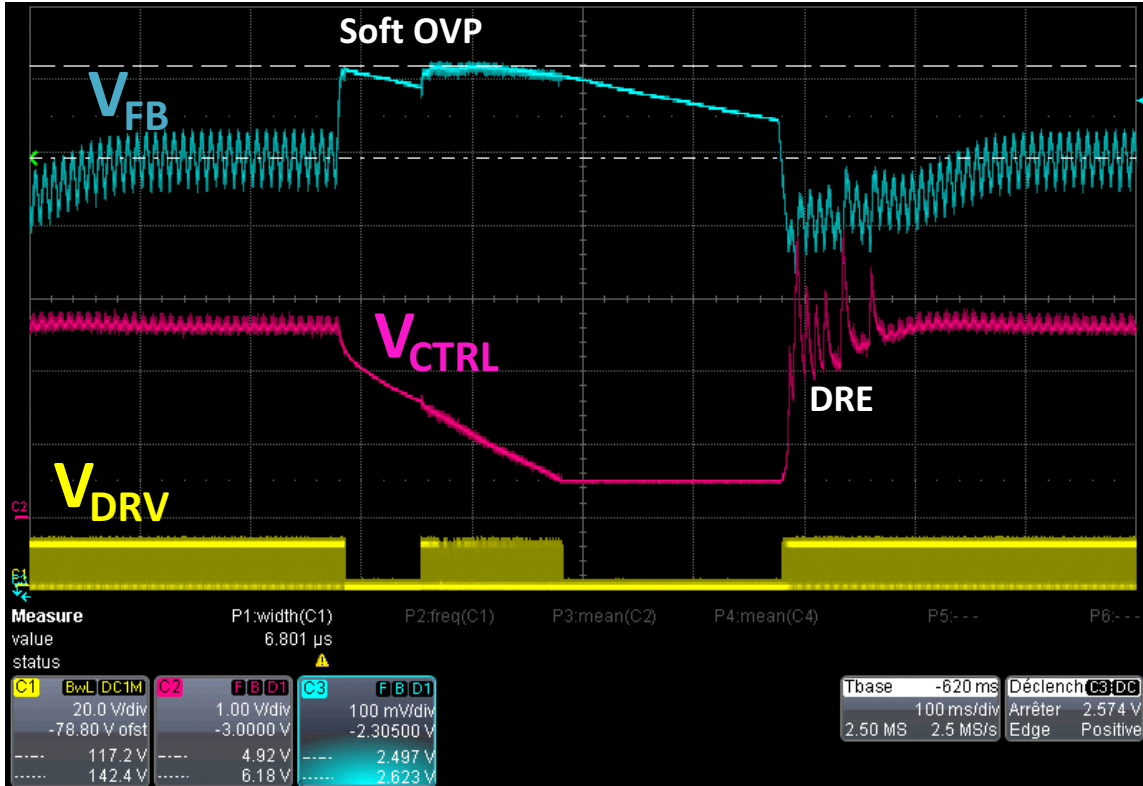

Figure 12. Load Current Transient Featuring Soft OVP and DRE  
@  $I_{LOAD} = 400 \text{ mA}/0 \text{ mA}$ ,  $V_{MAINS} = 110 \text{ V rms}$ ,  $V_{CC} = 20 \text{ V}$

BEHAVIOR UNDER FAILURE SITUATIONS

Elements of the PFC stage can be accidentally shorted, badly soldered or damaged as a result of manufacturing incidents, of an excessive operating stress or of other troubles. In particular, adjacent pins of controllers can be shorted, a pin, grounded or badly connected. It is often required that such open/short situations do not cause fire, smoke nor loud noise. The NCP1602 integrates functions that help meet this requirement, for instance, in case of an improper pin connection (including GND) or of a short of the boost or bypass diode.

As an example, we will illustrate here the circuit operation when the PFC bypass diode is shorted. When the PFC stage is plugged in, a large in-rush current takes place that charges the bulk capacitor to the line peak voltage. Traditionally, a bypass diode (D<sub>2</sub> in the application schematic of Figure 2) is placed between the input and output high-voltage rails to divert this inrush current from the inductor and boost diode. When it is shorted, the bulk voltage being equal to the input voltage, the inductor slightly demagnetizes owing to the boost diode voltage drop. As this voltage is small, the demagnetization can be extremely long. This is generally far insufficient to prevent a cycle-by-cycle cumulative rise of the inductor current and an unsafe heating of the inductor, the MOSFET and the boost diode. As the internal 1602 watchdog may kick in during this long demagnetization

period, continuous conduction mode (CCM) can occur for a few cycles. The NCP1602 incorporates a second over-current comparator that trips whenever the MOSFET current happens to exceed 150% of its maximum level. Such an event can happen when a) the watchdog restarts a cycle as explained before b) if the current slope is so sharp that the main over-current comparator cannot prevent the current from exceeding this second level as the result of the inductor saturation for instance. In this case, the circuit detects an “overstress” situation and disables the driver for an 800-μs delay. This long delay leads to a very low duty-ratio operation to dramatically limit the risk of overheating. Figure 13 illustrates the operation while the bypass diode and the NTC are both shorted @ V<sub>MAINS</sub> = 110 V with a 400-mA load current, the NCP1602 being supplied by a 20-V external power source. When the bypass diode is shorted, the demagnetization of the inductor takes too much time and the 200-μs Watchdog timer helps to start a new on-time, during which the OCP limit is reached. Because the previous demag was not reached and OCP is triggered, a 800-μs timer is used before allowing to start a new on-time. This helps limit the current resulting from the shorting of the bypass diode and the very low duty-ratio prevents the application from heating up.

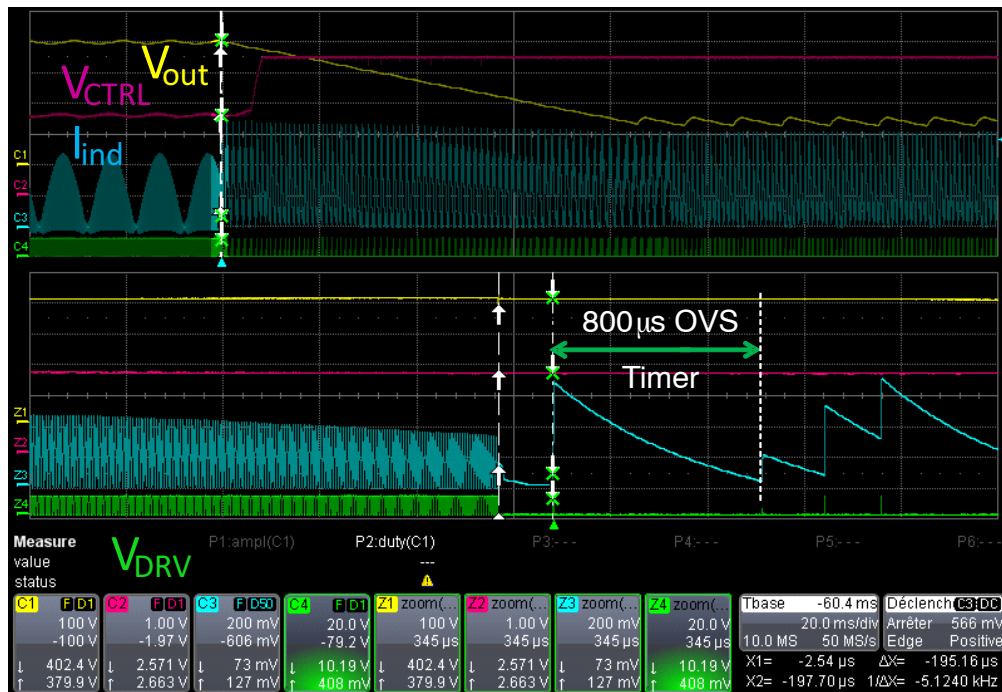

Figure 13. From Steady Stage the Bypass Diode is Shorted  
 @ V<sub>MAINS</sub> = 110 V rms, F<sub>MAINS</sub> = 60 Hz, I<sub>LOAD</sub> = 400 mA, NTC Shorted

**CAUTION:** Please note that we do not guarantee that the a NCP1602-driven PFC stage necessarily passes all the safety tests and in particular the boost diode short one since the performance can vary with respect to the application or conditions. The reported tests are intended to illustrate the typical behavior of the part in one particular application, highlighting the protections helping pass the safety tests. The reported tests were made at 25°C ambient temperature.

# NCP1602GEVB

## BILL OF MATERIALS

**Table 3. NCP1602GEVB BILL OF MATERIALS**

Reference	Qty.	Description	Value	Tolerance/ Constraints	Footprint	Manufacturer	Part Number
C1, C2	2	Y Capacitors	1 nF	400 V	Through-Hole	TDK	CD70ZU2GA102MYNKA
C4, C3A, C3B, C3C	4	X2 Capacitors	220 nF	305 V ac	Through-Hole	EPCOS	B32922C3224K
C5	1	Filtering Capacitors	470 nF	400 V	Through-Hole	EPCOS	B32592N6474K
C5A, C5B	2	Filtering Capacitors	220 nF	400 V	Through-Hole	EPCOS	B32522-E6224-K000
C7	1	Electrolytic Capacitor	22 $\mu$ F	50 V	Through-Hole	Various	Various
C6A, C6B	2	Bulk Capacitor	68 $\mu$ F	450 V	Through-Hole	RuBYCON	450QXW68M12.5X40
C13	1	Capacitor	100 nF	50 V	SMD, 1206	Various	Various
C10	1	Capacitor	220 nF	50 V	SMD, 1206	Various	Various
C9	1	Capacitor	2.2 $\mu$ F	50 V	SMD, 1206	Various	Various
C11, C12	2	Capacitor	NC	50 V	SMD, 1206	Various	Various
CM1	1	Common Mode Filter	2 $\times$ 3.3 mH	5 A	Through-Hole	Würth Elektronik	750341632
L2	1	Boost Inductor	200 $\mu$ H	6 A pk	Through-Hole	Würth Elektronik	750370081 (EFD30)
D1	1	Boost Diode	MUR550	5 A, 520 V	Through-Hole	ON Semiconductor	MUR550APFG
D2	1	Bypass Diode	1N5406	3 A, 600 V	Through-Hole	ON Semiconductor	1N5406G
D3, D4	2	Switching Diode	1N4148	100 V	SOD123	ON Semiconductor	MMSD4148T1G
DZ2	1	33-V Zener Diode	MMSZ33T1	33 V, 0.5 W	SOD123	ON Semiconductor	MMSZ33T1G
U1	1	Diodes Bridge	GBU406	4 A, 600 V	Through-Hole	LITE-ON	GBU406
Q1	1	Power MOSFET	IPA50R250CP	550 V	TO220_C	Infineon	IPA50R250CP
R8	1	Resistor	680 k $\Omega$	1%, 1/4 W	SMD, 1206	Various	Various
R9, R10	2	Resistor	1800 k $\Omega$	1%, 1/4 W	SMD, 1206	Various	Various
R27	1	Resistor	0 $\Omega$	1%, 1/4 W	SMD, 1206	Various	Various
R11	1	Resistor	27 k $\Omega$	1%, 1/4 W	SMD, 1206	Various	Various
C8	1	Capacitor	1 nF	10%, 25 V	SMD, 1206	Various	Various
R22	1	Resistor	5.1 M $\Omega$	1%, 1/4 W	SMD, 1206	Various	Various
R23	1	Resistor	240 k $\Omega$	1%, 1/4 W	SMD, 1206	Various	Various
R24	1	Resistor	240 k $\Omega$	1%, 1/4 W	SMD, 1206	Various	Various
Q2	1	Switch MOSFET	NC	NA	NA	NA	NA
R30	1	Resistor	0 $\Omega$	NA	NA	NA	NA
R21	1	Resistor	39 k $\Omega$	1%, 1/4 W	SMD, 1206	Various	Various
R31	1	Resistor	10 k $\Omega$	1%, 1/4 W	SMD, 1206	Various	Various
R32	1	Resistor	NC	NA	NA	NA	NA
R33	1	Resistor	NC	NA	NA	NA	NA
R42	1	Resistor	NC	NA	NA	NA	NA
R41	1	Resistor	NC	NA	NA	NA	NA
R40	1	Resistor	NC	NA	NA	NA	NA
C30	1	Capacitor	NC	NA	NA	NA	NA
D6	1	Diode	NC	NA	NA	NA	NA
D5	1	Diode	NC	NA	NA	NA	NA
R39	1	Resistor	NC	NA	NA	NA	NA
R37	1	Resistor	NC	NA	NA	NA	NA
R36	1	Resistor	NC	NA	NA	NA	NA
R38	1	Resistor	NC	NA	NA	NA	NA
R34	1	Resistor	NC	NA	NA	NA	NA
R3	1	Resistor	80 m $\Omega$	1%, 3 W	Through-Hole	Vishay	LVR03R0800FE12
R1, R2	2	X2 Capacitor Discharge Resistors	1000 k $\Omega$	1%, 500 V	SMD, 1206	Various	Various

# NCP1602GEVB

**Table 3. NCP1602GEVB BILL OF MATERIALS** (continued)

Reference	Qty.	Description	Value	Tolerance/ Constraints	Footprint	Manufacturer	Part Number
R12	1	Resistor	22 k $\Omega$	1%, 1/4 W	SMD, 1206	Various	Various
R4	1	Resistor	10 k $\Omega$	10%, 1/4 W	SMD, 1206	Various	Various
R5	1	Resistor	2.2 $\Omega$	10%, 1/4 W	SMD, 1206	Various	Various
R6	1	Resistor	22 $\Omega$	10%, 1/4 W	SMD, 1206	Various	Various
R7, RZ	2	Resistors	0 $\Omega$	1%, 1/4 W	SMD, 1206	Various	Various
U2	1	PFC Controller	NCP1602-AEA	NA	TSOP6	ON Semiconductor	NCP1602-AEA
RTH1	1	Inrush Current Limiter	B57153S150M	1.8 A max	Through-Hole	EPCOS	B57153S0150M000
F1	1	4-A Fuse	4A-250V	250 V	Through-Hole	Multicomp	MCPEP 4 A 250 V
HS1	1	Heatsink_KL_195	-	-	-	COLUMBIA-STAVER	TP207ST, 120, 12.5, NA, SP, 03

## REFERENCES

- [1] “5 Key Steps to Designing a Compact, High-Efficiency PFC Stage Using The NCP1602”, Application note AND9218/D, [http://www.onsemi.com/pub\\_link/Collateral/AND9218-D.PDF](http://www.onsemi.com/pub_link/Collateral/AND9218-D.PDF)
- [2] Data Sheet NCP1602/D, [http://www.onsemi.com/pub\\_link/Collateral/NCP1602-D.PDF](http://www.onsemi.com/pub_link/Collateral/NCP1602-D.PDF)
- [3] NCP1602 Evaluation Board User’s Manual [https://cma.onsemi.com/pub\\_link/Collateral/EVBU M2302-D.PDF](https://cma.onsemi.com/pub_link/Collateral/EVBU M2302-D.PDF)

# NCP1602GEVB

## ANNEX

(Schematic & BOM for modifying the evaluation board in order to use the auxiliary winding voltage instead of the power MOSFET drain voltage for CS/ZCD pin)

While this evaluation board uses the power MOSFET drain voltage for ZCD detection using the CS/ZCD pin, it is possible to configure this same evaluation board for using the auxiliary winding voltage to feed the CS/ZCD pin for ZCD detection. The power section of the schematic does not change, it is only the control schematic which changes. The components on the path between the power MOSFET drain and CS/ZCD pin must be removed and new components placed between the auxiliary winding voltage ( $V_{AUX}$ ) and CS/ZCD pin must be added. The details of this modification are entirely described by the schematic of Figure 14 and, the bill of materials of Table 4. Application note AND9218/D [1] gives the design procedure and equations.

Using the schematic using Aux Winding Voltage has pros and cons.

Pros:

- $R_{38}$  and  $R_{39}$  Value can be Small and Sensitivity to Noise and Parasitic Capacitance is Reduced
- Consumes No Power during Standby even if  $R_{38}$  and  $R_{39}$  Value are Small

Cons:

- Brown-Out Detection is Not Possible when Using Brown-Out Activated Product Option
- The Simple Inductor Becomes a Transformer to which an Auxiliary Winding is Added

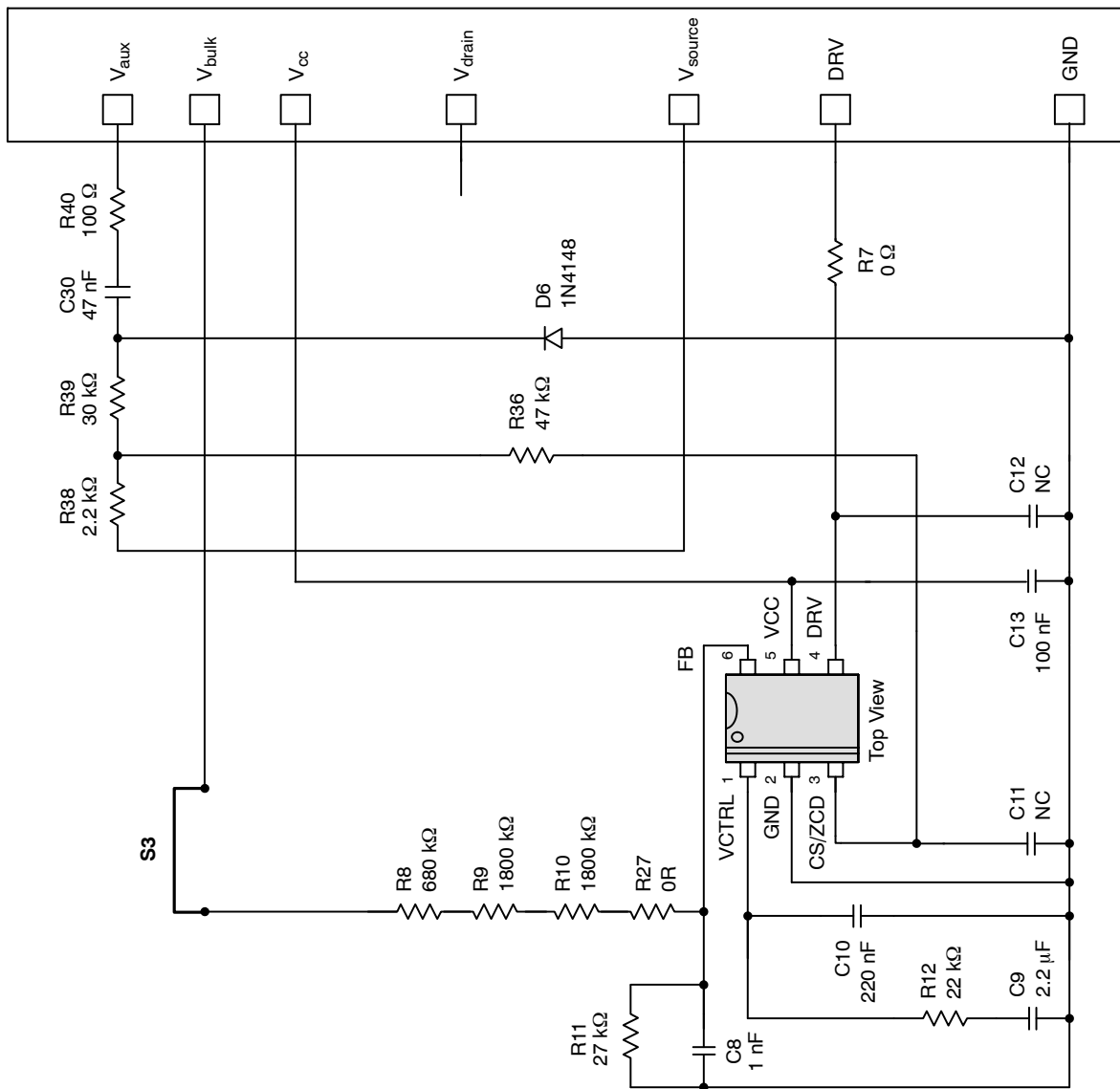

Figure 14. Application Schematic – Control Section for ZCD Detection using Auxiliary Winding ( $V_{AUX}$ )

# NCP1602GEVB

**Table 4. NCP1602GEVB BILL OF MATERIALS FOR ZCD DETECTION USING AUXILIARY WINDING (V<sub>AUX</sub>)**

Reference	Qty.	Description	Value	Tolerance/ Constraints	Footprint	Manufacturer	Part Number
C1, C2	2	Y Capacitors	1 nF	400 V	Through-Hole	TDK	CD70ZU2GA102MYNKA
C4, C3A, C3B, C3C	4	X2 Capacitors	220 nF	305 V ac	Through-Hole	EPCOS	B32922C3224K
C5	1	Filtering Capacitors	470 nF	400 V	Through-Hole	EPCOS	B32592N6474K
C5A, C5B	2	Filtering Capacitors	220 nF	400 V	Through-Hole	EPCOS	B32522-E6224-K000
C7	1	Electrolytic Capacitor	22 $\mu$ F	50 V	Through-Hole	Various	Various
C6A, C6B	2	Bulk Capacitor	68 $\mu$ F	450 V	Through-Hole	RuBYCON	450QXW68M12.5X40
C13	1	Capacitor	100 nF	50 V	SMD, 1206	Various	Various
C10	1	Capacitor	220 nF	50 V	SMD, 1206	Various	Various
C9	1	Capacitor	2.2 $\mu$ F	50 V	SMD, 1206	Various	Various
C11, C12	2	Capacitor	NC	50 V	SMD, 1206	Various	Various
CM1	1	Common Mode Filter	2 $\times$ 3.3 mH	5 A	Through-Hole	Würth Elektronik	750341632
L2	1	Boost Inductor	200 $\mu$ H	6 A pk	Through-Hole	Würth Elektronik	750370081 (EFD30)
D1	1	Boost Diode	MUR550	5 A, 520 V	Through-Hole	ON Semiconductor	MUR550APFG
D2	1	Bypass Diode	1N5406	3 A, 600 V	Through-Hole	ON Semiconductor	1N5406G
D3, D4	2	Switching Diode	1N4148	100 V	SOD123	ON Semiconductor	MMSD4148T1G
DZ2	1	33-V Zener Diode	MMSZ33T1	33 V, 0.5 W	SOD123	ON Semiconductor	MMSZ33T1G
U1	1	Diodes Bridge	GBU406	4 A, 600 V	Through-Hole	LITE-ON	GBU406
Q1	1	Power MOSFET	IPA50R250CP	550 V	TO220_C	Infineon	IPA50R250CP
R8	1	Resistor	680 k $\Omega$	1%, 1/4 W	SMD, 1206	Various	Various
R9, R10	2	Resistor	1800 k $\Omega$	1%, 1/4 W	SMD, 1206	Various	Various
R27	1	Resistor	0 $\Omega$	1%, 1/4 W	SMD, 1206	Various	Various
R11	1	Resistor	27 k $\Omega$	1%, 1/4 W	SMD, 1206	Various	Various
C8	1	Capacitor	1 nF	10%, 25 V	SMD, 1206	Various	Various
R22	1	Resistor	NC	NA	NA	NA	NA
R23	1	Resistor	NC	NA	NA	NA	NA
R24	1	Resistor	NC	NA	NA	NA	NA
Q2	1	Switch MOSFET	NC	NA	NA	NA	NA
R30	1	Resistor	NC	NA	NA	NA	NA
R21	1	Resistor	0 $\Omega$	1%, 1/4 W	SMD, 1206	Various	Various
R31	1	Resistor	NC	NA	NA	NA	NA
R32	1	Resistor	NC	NA	NA	NA	NA
R33	1	Resistor	NC	NA	NA	NA	NA
R42	1	Resistor	NC	NA	NA	NA	NA
R41	1	Resistor	0 $\Omega$	1%, 1/4 W	SMD, 1206	Various	Various
R40	1	Resistor	100 $\Omega$	10%, 1/4 W	SMD, 1206	Various	Various
C30	1	Capacitor	47 nF	1%, 25 V	SMD, 1206	Various	Various
D6	1	Diode	1N4148	100 V	SOD123	ON Semiconductor	MMSD4148T1G
D5	1	Diode	0 $\Omega$	1%, 1/4 W	SMD, 1206	Various	Various
R39	1	Resistor	30 k $\Omega$	1%, 1/4 W	SMD, 1206	Various	Various
R37	1	Resistor	0 $\Omega$	1%, 1/4 W	SMD, 1206	Various	Various
R36	1	Resistor	47 k $\Omega$	1%, 1/4 W	SMD, 1206	Various	Various
R38	1	Resistor	2.2 k $\Omega$	1%, 1/4 W	SMD, 1206	Various	Various
R34	1	Resistor	0 $\Omega$	1%, 1/4 W	SMD, 1206	Various	Various
R3	1	Resistor	80 m $\Omega$	1%, 3 W	Through-Hole	Vishay	LVR03R0800FE12
R1, R2	2	X2 Capacitor Discharge Resistors	1000 k $\Omega$	1%, 500 V	SMD, 1206	Various	Various
R12	1	Resistor	22 k $\Omega$	1%, 1/4 W	SMD, 1206	Various	Various
R4	1	Resistor	10 k $\Omega$	10%, 1/4 W	SMD, 1206	Various	Various



# NCP1602GEVB

**Table 4. NCP1602GEVB BILL OF MATERIALS FOR ZCD DETECTION USING AUXILIARY WINDING ( $V_{AUX}$ ) (continued)**

Reference	Qty.	Description	Value	Tolerance/ Constraints	Footprint	Manufacturer	Part Number
R5	1	Resistor	2.2 $\Omega$	10%, 1/4 W	SMD, 1206	Various	Various
R6	1	Resistor	22 $\Omega$	10%, 1/4 W	SMD, 1206	Various	Various
R7, RZ	2	Resistors	0 $\Omega$	1%, 1/4 W	SMD, 1206	Various	Various
U2	1	PFC Controller	NCP1602-AEA	NA	TSOP6	ON Semiconductor	NCP1602-AEA
RTH1	1	Inrush Current Limiter	B57153S150M	1.8 A max	Through-Hole	EPCOS	B57153S0150M000
F1	1	4-A Fuse	4A-250V	250 V	Through-Hole	Multicomp	MCPEP 4 A 250 V
HS1	1	Heatsink_KL_195	-	-	-	COLUMBIA-STAVER	TP207ST, 120, 12.5, NA, SP, 03

**onsemi**, **Onsemi**, and other names, marks, and brands are registered and/or common law trademarks of Semiconductor Components Industries, LLC dba "**onsemi**" or its affiliates and/or subsidiaries in the United States and/or other countries. **onsemi** owns the rights to a number of patents, trademarks, copyrights, trade secrets, and other intellectual property. A listing of **onsemi**'s product/patent coverage may be accessed at [www.onsemi.com/site/pdf/Patent-Marking.pdf](http://www.onsemi.com/site/pdf/Patent-Marking.pdf). **onsemi** is an Equal Opportunity/Affirmative Action Employer. This literature is subject to all applicable copyright laws and is not for resale in any manner.

The evaluation board/kit (research and development board/kit) (hereinafter the "board") is not a finished product and is not available for sale to consumers. The board is only intended for research, development, demonstration and evaluation purposes and will only be used in laboratory/development areas by persons with an engineering/technical training and familiar with the risks associated with handling electrical/mechanical components, systems and subsystems. This person assumes full responsibility/liability for proper and safe handling. Any other use, resale or redistribution for any other purpose is strictly prohibited.

**THE BOARD IS PROVIDED BY ONSEMI TO YOU "AS IS" AND WITHOUT ANY REPRESENTATIONS OR WARRANTIES WHATSOEVER. WITHOUT LIMITING THE FOREGOING, ONSEMI (AND ITS LICENSORS/SUPPLIERS) HEREBY DISCLAIMS ANY AND ALL REPRESENTATIONS AND WARRANTIES IN RELATION TO THE BOARD, ANY MODIFICATIONS, OR THIS AGREEMENT, WHETHER EXPRESS, IMPLIED, STATUTORY OR OTHERWISE, INCLUDING WITHOUT LIMITATION ANY AND ALL REPRESENTATIONS AND WARRANTIES OF MERCHANTABILITY, FITNESS FOR A PARTICULAR PURPOSE, TITLE, NON-INFRINGEMENT, AND THOSE ARISING FROM A COURSE OF DEALING, TRADE USAGE, TRADE CUSTOM OR TRADE PRACTICE.**

**onsemi** reserves the right to make changes without further notice to any board.

You are responsible for determining whether the board will be suitable for your intended use or application or will achieve your intended results. Prior to using or distributing any systems that have been evaluated, designed or tested using the board, you agree to test and validate your design to confirm the functionality for your application. Any technical, applications or design information or advice, quality characterization, reliability data or other services provided by **onsemi** shall not constitute any representation or warranty by **onsemi**, and no additional obligations or liabilities shall arise from **onsemi** having provided such information or services.

**onsemi** products including the boards are not designed, intended, or authorized for use in life support systems, or any FDA Class 3 medical devices or medical devices with a similar or equivalent classification in a foreign jurisdiction, or any devices intended for implantation in the human body. You agree to indemnify, defend and hold harmless **onsemi**, its directors, officers, employees, representatives, agents, subsidiaries, affiliates, distributors, and assigns, against any and all liabilities, losses, costs, damages, judgments, and expenses, arising out of any claim, demand, investigation, lawsuit, regulatory action or cause of action arising out of or associated with any unauthorized use, even if such claim alleges that **onsemi** was negligent regarding the design or manufacture of any products and/or the board.

This evaluation board/kit does not fall within the scope of the European Union directives regarding electromagnetic compatibility, restricted substances (RoHS), recycling (WEEE), FCC, CE or UL, and may not meet the technical requirements of these or other related directives.

FCC WARNING – This evaluation board/kit is intended for use for engineering development, demonstration, or evaluation purposes only and is not considered by **onsemi** to be a finished end product fit for general consumer use. It may generate, use, or radiate radio frequency energy and has not been tested for compliance with the limits of computing devices pursuant to part 15 of FCC rules, which are designed to provide reasonable protection against radio frequency interference. Operation of this equipment may cause interference with radio communications, in which case the user shall be responsible, at its expense, to take whatever measures may be required to correct this interference.

**onsemi** does not convey any license under its patent rights nor the rights of others.

LIMITATIONS OF LIABILITY: **onsemi** shall not be liable for any special, consequential, incidental, indirect or punitive damages, including, but not limited to the costs of requalification, delay, loss of profits or goodwill, arising out of or in connection with the board, even if **onsemi** is advised of the possibility of such damages. In no event shall **onsemi**'s aggregate liability from any obligation arising out of or in connection with the board, under any theory of liability, exceed the purchase price paid for the board, if any.

The board is provided to you subject to the license and other terms per **onsemi**'s standard terms and conditions of sale. For more information and documentation, please visit [www.onsemi.com](http://www.onsemi.com).

## ADDITIONAL INFORMATION

### TECHNICAL PUBLICATIONS:

Technical Library: [www.onsemi.com/design/resources/technical-documentation](http://www.onsemi.com/design/resources/technical-documentation)  
onsemi Website: [www.onsemi.com](http://www.onsemi.com)

ONLINE SUPPORT: [www.onsemi.com/support](http://www.onsemi.com/support)

For additional information, please contact your local Sales Representative at [www.onsemi.com/support/sales](http://www.onsemi.com/support/sales)