

Thank you for your interest in **onsemi** products.  
Your technical document begins on the following pages.



## Your Feedback is Important to Us!

Please take a moment to participate in our short survey.  
At **onsemi**, we are dedicated to delivering technical content that best meets your needs.

### [Help Us Improve – Take the Survey](#)

This survey is intended to collect your feedback, capture any issues you may encounter, and to provide improvements you would like to suggest.

**We look forward to your feedback.**

To learn more about **onsemi**, please visit our website at  
[www.onsemi.com](http://www.onsemi.com)

**onsemi** and **onsemi** and other names, marks, and brands are registered and/or common law trademarks of Semiconductor Components Industries, LLC dba "**onsemi**" or its affiliates and/or subsidiaries in the United States and/or other countries. **onsemi** owns the rights to a number of patents, trademarks, copyrights, trade secrets, and other intellectual property. A listing of **onsemi** product/patent coverage may be accessed at [www.onsemi.com/site/pdf/Patent-Marking.pdf](http://www.onsemi.com/site/pdf/Patent-Marking.pdf). **onsemi** reserves the right to make changes at any time to any products or information herein, without notice. The information herein is provided "as-is" and **onsemi** makes no warranty, representation or guarantee regarding the accuracy of the information, product features, availability, functionality, or suitability of its products for any particular purpose, nor does **onsemi** assume any liability arising out of the application or use of any product or circuit, and specifically disclaims any and all liability, including without limitation special, consequential or incidental damages. Buyer is responsible for its products and applications using **onsemi** products, including compliance with all laws, regulations and safety requirements or standards, regardless of any support or applications information provided by **onsemi**. "Typical" parameters which may be provided in **onsemi** data sheets and/or specifications can and do vary in different applications and actual performance may vary over time. All operating parameters, including "Typicals" must be validated for each customer application by customer's technical experts. **onsemi** does not convey any license under any of its intellectual property rights nor the rights of others. **onsemi** products are not designed, intended, or authorized for use as a critical component in life support systems or any FDA Class 3 medical devices or medical devices with a same or similar classification in a foreign jurisdiction or any devices intended for implantation in the human body. Should Buyer purchase or use **onsemi** products for any such unintended or unauthorized application, Buyer shall indemnify and hold **onsemi** and its officers, employees, subsidiaries, affiliates, and distributors harmless against all claims, costs, damages, and expenses, and reasonable attorney fees arising out of, directly or indirectly, any claim of personal injury or death associated with such unintended or unauthorized use, even if such claim alleges that **onsemi** was negligent regarding the design or manufacture of the part. **onsemi** is an Equal Opportunity/Affirmative Action Employer. This literature is subject to all applicable copyright laws and is not for resale in any manner. Other names and brands may be claimed as the property of others.

# Fixed/Adjustable Current-Limiting Power-Distribution Switches

## NCP380, NCV380

The NCP380 is a high side power-distribution switch designed for applications where heavy capacitive loads and short-circuits are likely to be encountered. The device includes an integrated 55 mΩ (DFN package), P-channel MOSFET. The device limits the output current to a desired level by switching into a constant-current regulation mode when the output load exceeds the current-limit threshold or a short is present. The current-limit threshold is either user adjustable between 500 mA and 2.1 A via an external resistor or internally fixed. The power-switch rise and fall times are controlled to minimize current ringing during switching.

An internal reverse-voltage detection comparator disables the power-switch if the output voltage is higher than the input voltage to protect devices on the input side of the switch.

The  $\overline{\text{FLAG}}$  logic output asserts low during over current, reverse-voltage or over temperature conditions. The switch is controlled by a logic enable input active high or low.

### Features

- 2.5 V – 5.5 V Operating Range
- 70 mΩ High-side MOSFET
- Current Limit:
  - ◆ User adjustable from 500 mA to 2.1 A
  - ◆ Fixed 500 mA, 1 A, 1.5 A, 2 A and 2.1 A
- Under Voltage Lock-out (UVLO)
- Built-in Soft-start
- Thermal Protection
- Soft Turn-off
- Reverse Voltage Protection
- Junction Temperature Range: -40°C to 125°C
- Enable Active High or Low (EN or  $\overline{\text{EN}}$ )
- Compliance to IEC61000-4-2 (Level 4)
  - ◆ 8.0 kV (Contact)
  - ◆ 15 kV (Air)
- UL Listed – File No. E343275 (NCP Versions Only)
- NCV Prefix for Automotive and Other Applications Requiring Unique Site and Control Change Requirements; AEC-Q100 Qualified and PPAP Capable
- These are Pb-Free Devices

### Typical Applications

- Laptops
- USB Ports/Hubs
- TVs



UDFN6  
CASE 517AB



TSOP-5  
CASE 483



TSOP-6  
CASE 318G

### MARKING DIAGRAMS

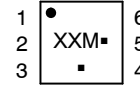

UDFN6

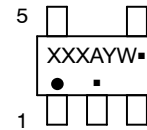

TSOP-5

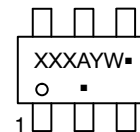

TSOP-6

XXX = Specific Device Code  
A = Assembly Location  
M = Date Code  
Y = Year  
W = Work Week  
▪ = Pb-Free Package

(Note: Microdot may be in either location)

### ORDERING INFORMATION

See detailed ordering and shipping information in the package dimensions section on page 20 of this data sheet.

# NCP380, NCV380

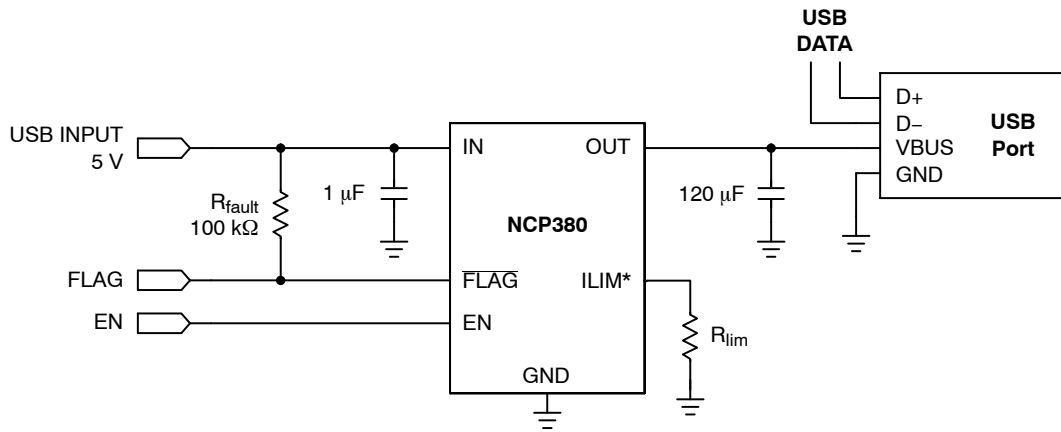

\*For Adjustable Version Only.

**Figure 1. Typical Application Circuit**

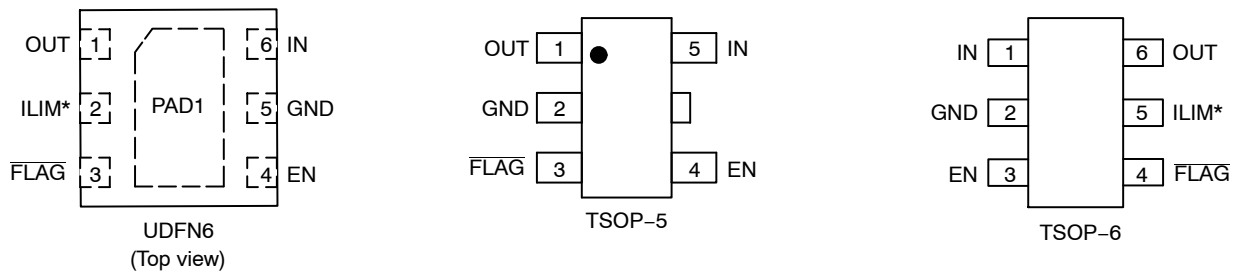

\*For adjustable version only, otherwise not connected.

**Figure 2. Pin Connections**

**Table 1. PIN FUNCTION DESCRIPTION**

Pin Name	Type	Description
EN	INPUT	Enable input, logic low/high (i.e. $\overline{EN}$ or EN) turns on power switch
GND	POWER	Ground connection;
IN	POWER	Power-switch input voltage; connect a 1 $\mu$ F or greater ceramic capacitor from IN to GND as close as possible to the IC.
FLAG	OUTPUT	Active-low open-drain output, asserted during overcurrent, overtemperature or reverse-voltage conditions. Connect a 10 k $\Omega$ or greater resistor pull-up, otherwise leave unconnected.
OUT	OUTPUT	Power-switch output; connect a 1 $\mu$ F ceramic capacitor from OUT to GND as close as possible to the IC is recommended. A 1 $\mu$ F or greater ceramic capacitor from OUT to GND must be connected if the USB requirement (i.e. 120 $\mu$ F capacitor minimum) is not met.
ILIM*	INPUT	External resistor used to set current-limit threshold; recommended $5 \text{ k}\Omega < R_{ILIM} < 250 \text{ k}\Omega$ .
PAD1**	THERMAL	Exposed Thermal Pad: Must be soldered to PCB Ground plane

\*(For adjustable version only, otherwise not connected.

\*\*For DFN version only.

# NCP380, NCV380

**Table 2. MAXIMUM RATINGS**

Rating	Symbol	Value	Unit
From IN to OUT Pins: Input/Output (Note 1)	$V_{IN}, V_{OUT}$	-7.0 to +7.0	V
IN, OUT, EN, ILIM, FLAG, Pins: Input/Output (Note 1)	$V_{EN}, V_{ILIM}, V_{FLAG}, V_{IN}, V_{OUT}$	-0.3 to +7.0	V
FLAG Sink Current	$I_{SINK}$	1	mA
$I_{LIM}$ Source Current	$I_{LIM}$	1	mA
ESD Withstand Voltage (IEC 61000-4-2) (Output Only, when Bypassed with 1.0 $\mu$ F Capacitor Minimum)	ESD IEC	15 Air, 8 Contact	kV
Human Body Model (HBM) ESD Rating (Note 2)	ESD HBM	2,000	V
Machine Model (MM) ESD Rating (Notes 2 and 3)	ESD MM	200	V
Latch-up Protection (Note 4) Pins IN, OUT, EN, ILIM, FLAG	LU	100	mA
Maximum Junction Temperature Range (Note 6)	$T_J$	-40 to +TSD	$^{\circ}$ C
Storage Temperature Range	$T_{STG}$	-40 to +150	$^{\circ}$ C
Moisture Sensitivity (Note 5)	MSL	Level 1	

Stresses exceeding those listed in the Maximum Ratings table may damage the device. If any of these limits are exceeded, device functionality should not be assumed, damage may occur and reliability may be affected.

1. According to JEDEC standard JESD22-A108.
2. This device series contains ESD protection and passes the following tests:  
Human Body Model (HBM)  $\pm 2.0$  kV per JEDEC standard: JESD22-A114 for all pins.  
Machine Model (MM)  $\pm 200$  V per JEDEC standard: JESD22-A115 for all pins.
3. Except EN pin, 150 V.
4. Latch up Current Maximum Rating:  $\pm 100$  mA per JEDEC standard: JESD78 class II.
5. Moisture Sensitivity Level (MSL): 1 per IPC/JEDEC standard: J-STD-020.
6. A thermal shutdown protection avoids irreversible damage on the device due to power dissipation.

**Table 3. OPERATING CONDITIONS**

Symbol	Parameter	Conditions	Min	Typ	Max	Unit	
$V_{IN}$	Operational Power Supply		2.5	-	5.5	V	
$V_{EN}$	Enable Voltage		0	-	5.5		
$T_A$	Ambient Temperature Range		-40	25	+85	$^{\circ}$ C	
$T_J$	Junction Temperature Range		-40	25	+125	$^{\circ}$ C	
$R_{ILIM}$	Resistor from ILIM to GND Pin		5.0	-	250	k $\Omega$	
$I_{SINK}$	FLAG Sink Current		-	-	1.0	mA	
$C_{IN}$	Decoupling Input Capacitor		1.0	-	-	$\mu$ F	
$C_{OUT}$	Decoupling Output Capacitor	USB Port per Hub	120	-	-	$\mu$ F	
$R_{\theta JA}$	Thermal Resistance Junction-to-Air	UDFN-6 Package (Notes 7 and 8)	-	120	-	$^{\circ}$ C/W	
		TSOP-5 Package (Notes 7 and 8)	-	305	-	$^{\circ}$ C/W	
		TSOP-6 Package (Notes 7 and 8)	-	280	-	$^{\circ}$ C/W	
$I_{OUT}$	Maximum DC Current	UDFN-6 Package	-	-	2.1	A	
		TSOP-5, TSOP-6 Package	-	-	1.0	A	
$P_D$	Power Dissipation Rating (Note 9)	$T_A \leq 25^{\circ}$ C	UDFN-6 Package	-	830	-	mW
			TSOP-5 Package	-	325	-	mW
			TSOP-6 Package	-	350	-	mW
		$T_A = 85^{\circ}$ C	UDFN-6 Package	-	325	-	mW
			TSOP-5 Package	-	130	-	mW
		TSOP-6 Package	-	145	-	mW	

7. A thermal shutdown protection avoids irreversible damage on the device due to power dissipation.
8. The  $R_{\theta JA}$  is dependent of the PCB heat dissipation. Board used to drive this data was a 2" x 2" NCP380EVB board. It is a 2 layers board with 2-ounce copper traces on top and bottom of the board. Exposed pad is connected to ground plane for UDFN-6 version only.
9. The maximum power dissipation ( $P_D$ ) is given by the following formula:

$$P_D = \frac{T_{JMAX} - T_A}{R_{\theta JA}}$$

# NCP380, NCV380

**Table 4. ELECTRICAL CHARACTERISTICS**

(Min & Max Limits apply for  $T_A$  between  $-40^\circ\text{C}$  to  $+85^\circ\text{C}$  and  $T_J$  up to  $+125^\circ\text{C}$  for  $V_{IN}$  between 2.5 V to 5.5 V (Unless otherwise noted). Typical values are referenced to  $T_A = +25^\circ\text{C}$  and  $V_{IN} = 5\text{ V}$ .)

Symbol	Parameter	Conditions	Min	Typ	Max	Unit		
<b>POWER SWITCH</b>								
$R_{DS(on)}$	Static Drain-source On-state Resistance	DFN Package	$V_{IN} = 5\text{ V}$	$-40^\circ\text{C} < T_J < 125^\circ\text{C}$	–	55	75	$\text{m}\Omega$
			$2.5\text{ V} < V_{IN} < 5.5\text{ V}$	$-40^\circ\text{C} < T_J < 125^\circ\text{C}$	–	–	110	
	TSOP Package		$V_{IN} = 5\text{ V}$	$-40^\circ\text{C} < T_J < 125^\circ\text{C}$	–	70	95	$\text{m}\Omega$
			$2.5\text{ V} < V_{IN} < 5.5\text{ V}$	$-40^\circ\text{C} < T_J < 125^\circ\text{C}$	–	–	135	
$T_R$	Output Rise Time	$C_{LOAD} = 1\ \mu\text{F}$ , $R_{LOAD} = 100\ \Omega$ (Note 10)	$V_{IN} = 5\text{ V}$	0.3	1.0	1.5	ms	
			$V_{IN} = 2.5\text{ V}$	0.2	0.65	1.0		
$T_F$	Output Fall Time		$V_{IN} = 5\text{ V}$	0.1	–	0.5		
			$V_{IN} = 2.5\text{ V}$	0.1	–	0.5		
<b>ENABLE INPUT EN OR <math>\overline{\text{EN}}</math></b>								
$V_{IH}$	High-level Input Voltage		1.2	–	–	V		
$V_{IL}$	Low-level Input Voltage		–	–	0.4	V		
$I_{EN}$	Input Current	$V_{EN} = 0\text{ V}$ , $\overline{V_{EN}} = 5\text{ V}$	–0.5	–	0.5	$\mu\text{A}$		
$T_{ON}$	Turn On Time	$C_{LOAD} = 1\ \mu\text{F}$ , $R_{LOAD} = 100\ \Omega$ (Note 11)	2.0	3.0	4.0	ms		
$T_{OFF}$	Turn Off Time		1.0	–	3.0	ms		
<b>CURRENT LIMIT</b>								
$I_{OCP}$	Current-limit Threshold (Maximum DC Output Current $I_{OUT}$ Delivered to Load)	$V_{IN} = 5\text{ V}$	$R_{ILIM} = 20\ \text{k}\Omega$ (Note 11)	1.02	1.20	1.38	A	
			$R_{ILIM} = 40\ \text{k}\Omega$ (Notes 11 and 13)	0.595	0.700	0.805		
			Fixed 0.5 A (Note 12)	0.5	0.58	0.65	A	
			Fixed 1.0 A (Note 12)	1.0	1.15	1.3		
			Fixed 1.5 A (Note 12)	1.5	1.75	1.9		
			Fixed 2.0 A (Note 12)	2.0	2.25	2.5		
	Fixed 2.1 A (Note 12)	2.1	2.25	2.5				
$T_{DET}$	Response Time to Short Circuit	$V_{IN} = 5\text{ V}$	–	2.0	–	$\mu\text{s}$		
$T_{REG}$	Regulation Time		1.8	3.0	4.0	ms		
$T_{OCP}$	Overcurrent Protection Time		14	20	26	ms		
<b>REVERSE-VOLTAGE PROTECTION</b>								
$V_{REV}$	Reverse-voltage Comparator Trip Point ( $V_{OUT} - V_{IN}$ )		–	100	–	mV		
$T_{REV}$	Time from Reverse-voltage Condition to MOSFET Switch Off & FLAG Low	$V_{IN} = 5\text{ V}$	4.0	6.0	9.0	ms		
$T_{RREV}$	Re-arming Time		7.0	10	15	ms		
<b>UNDERVOLTAGE LOCKOUT</b>								
$V_{UVLO}$	IN Pin Low-level Input Voltage	$V_{IN}$ Rising	2.0	2.3	2.4	V		
$V_{HYST}$	IN Pin Hysteresis	$T_J = 25^\circ\text{C}$	25	–	60	mV		
$T_{RUVLO}$	Re-arming Time		7.0	10	15	ms		
<b>SUPPLY CURRENT</b>								
$I_{INOFF}$	Low-level Output Supply Current	$V_{IN} = 5\text{ V}$ , No Load on $O_{UT}$ , Device OFF $V_{EN} = 0\text{ V}$ or $\overline{V_{EN}} = 5\text{ V}$	–	1.0	2.1	$\mu\text{A}$		
$I_{INON}$	High-level Output Supply Current	$V_{IN} = 5\text{ V}$ , Device Enable	–	–	90	$\mu\text{A}$		
		2 A and 2.1 A Versions	–	–	80			
		1 A and 1.5 A Current Versions 0.5 A Current Version	–	–	70			
$I_{REV}$	Reverse Leakage Current	$V_{OUT} = 5\text{ V}$ , $V_{IN} = 0\text{ V}$	$T_J = 25^\circ\text{C}$	–	–	1.0	$\mu\text{A}$	

# NCP380, NCV380

**Table 4. ELECTRICAL CHARACTERISTICS** (continued)

(Min & Max Limits apply for  $T_A$  between  $-40^{\circ}\text{C}$  to  $+85^{\circ}\text{C}$  and  $T_J$  up to  $+125^{\circ}\text{C}$  for  $V_{IN}$  between 2.5 V to 5.5 V (Unless otherwise noted). Typical values are referenced to  $T_A = +25^{\circ}\text{C}$  and  $V_{IN} = 5\text{ V}$ .)

Symbol	Parameter	Conditions	Min	Typ	Max	Unit
<b>FLAG PIN</b>						
$V_{OL}$	FLAG Output Low Voltage	$I_{FLAG} = 1\text{ mA}$			400	mV
$I_{LEAK}$	Off-state Leakage	$V_{FLAG} = 5\text{ V}$			1.0	$\mu\text{A}$
$T_{FLG}$	FLAG Deglitch	FLAG De-assertion Time due to Overcurrent or Reverse Voltage Condition	4.0	6.0	9.0	ms
$T_{FOCP}$	FLAG Deglitch	FLAG Assertion due to Overcurrent	6.0	8.0	12	ms

## THERMAL SHUTDOWN

$T_{SD}$	Thermal Shutdown Threshold			140		$^{\circ}\text{C}$
$T_{SDOCP}$	Thermal Regulation Threshold			125		$^{\circ}\text{C}$
$T_{RSD}$	Thermal Shutdown Rearming Threshold			115		$^{\circ}\text{C}$

Product parametric performance is indicated in the Electrical Characteristics for the listed test conditions, unless otherwise noted. Product performance may not be indicated by the Electrical Characteristics if operated under different conditions.

10. Parameters are guaranteed for  $C_{LOAD}$  and  $R_{LOAD}$  connected to the OUT pin with respect to the ground, See Figure 3.

11. Adjustable current version,  $R_{LIM}$  tolerance  $\pm 1\%$ .

12. Fixed current version.

13. Not production test, guaranteed by characterization.

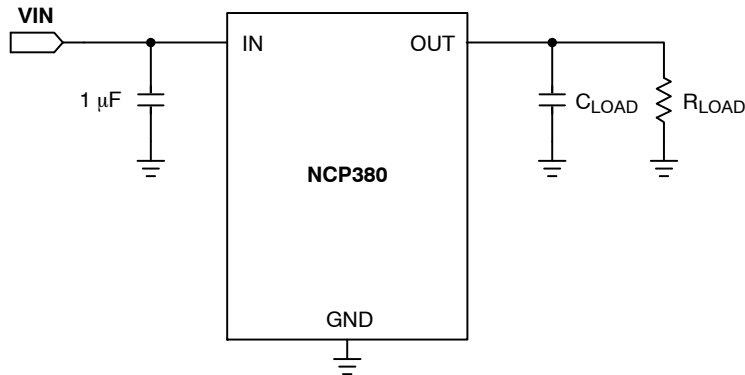

**Figure 3. Test Configuration**

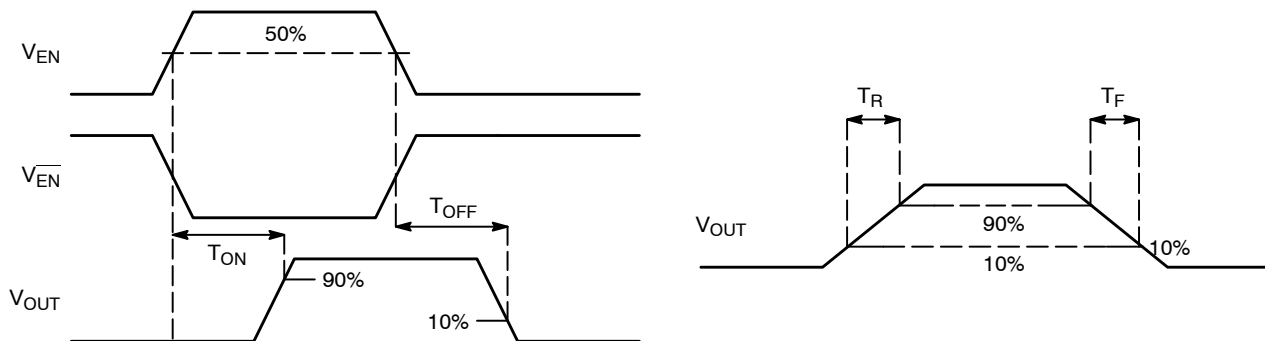

**Figure 4. Voltage Waveform**

# NCP380, NCV380

## BLOCK DIAGRAM

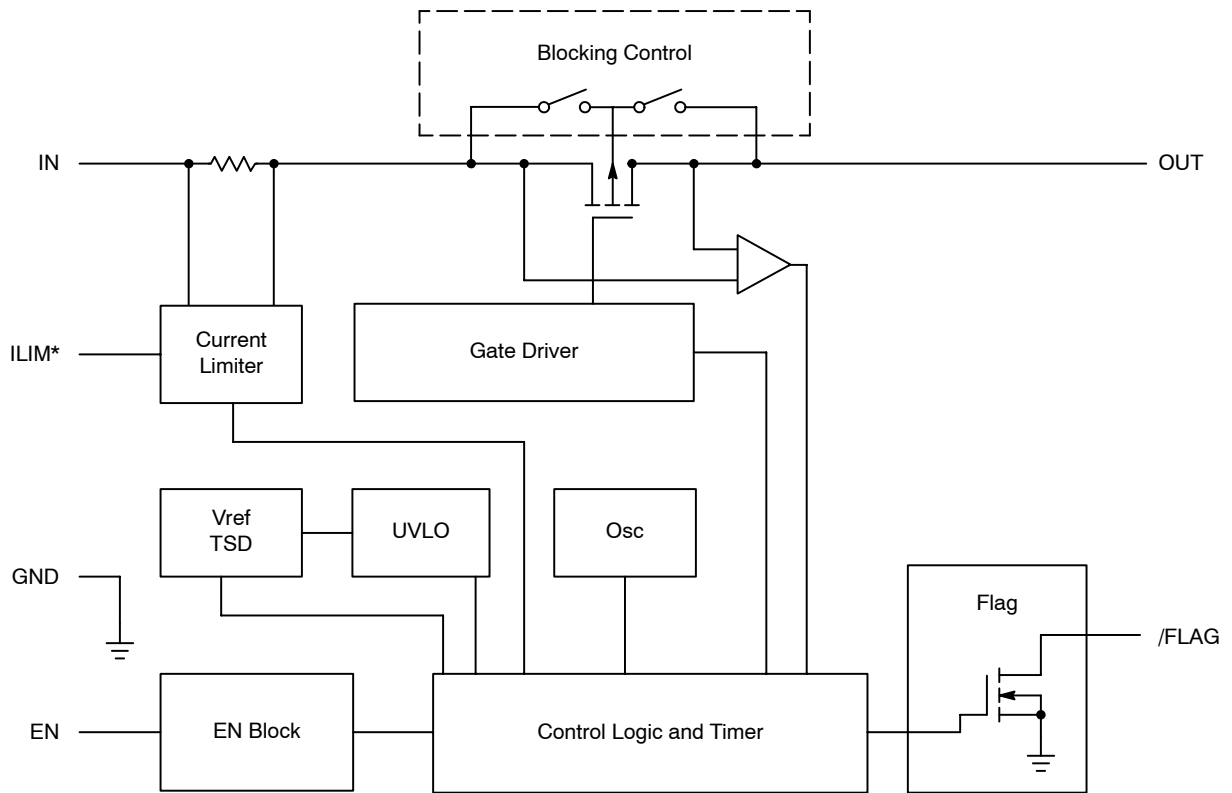

\*For adjustable version only, otherwise not connected.

**Figure 5. Block Diagram**

# NCP380, NCV380

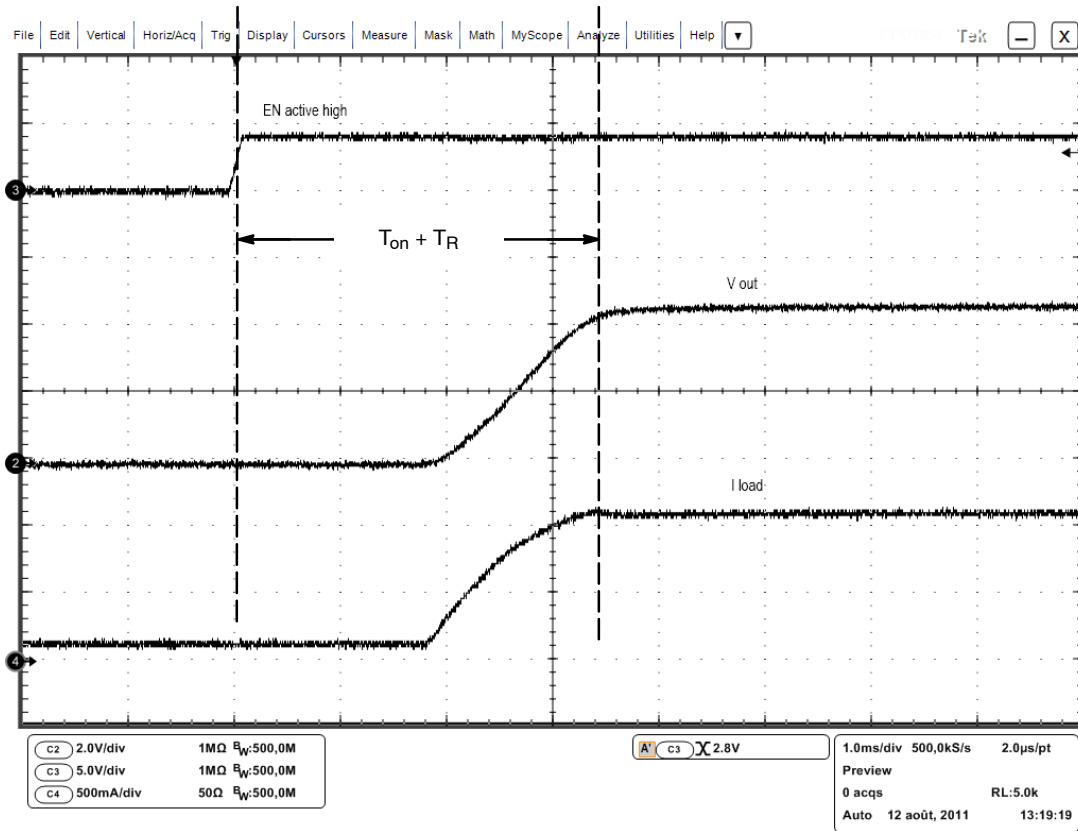

Figure 6.  $T_{on}$  Delay and  $T_{rise}$  Time

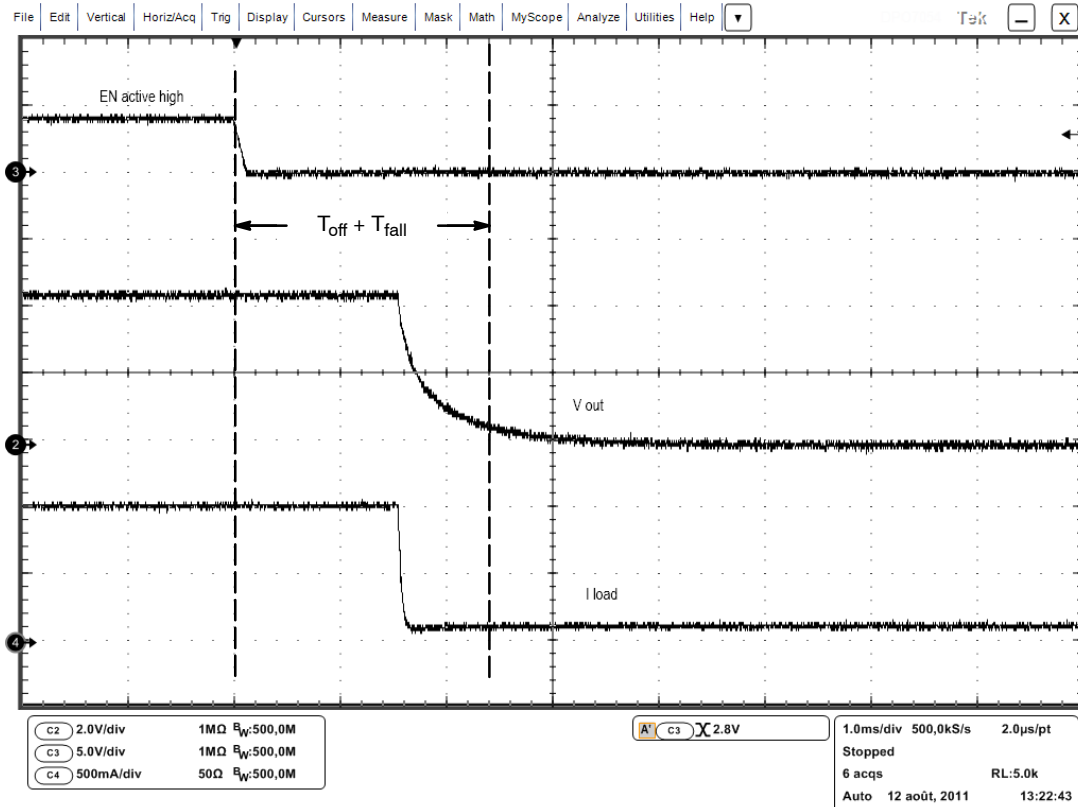

Figure 7.  $T_{off}$  Delay and  $T_{fall}$



# NCP380, NCV380

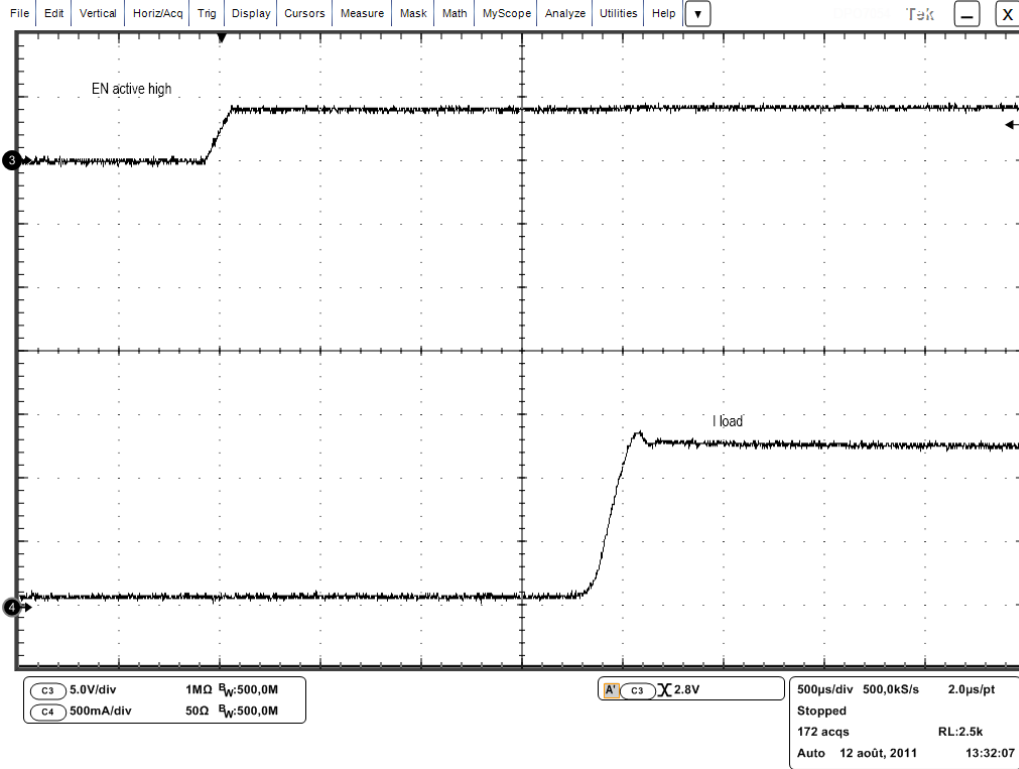

Figure 8. Turn On a Short

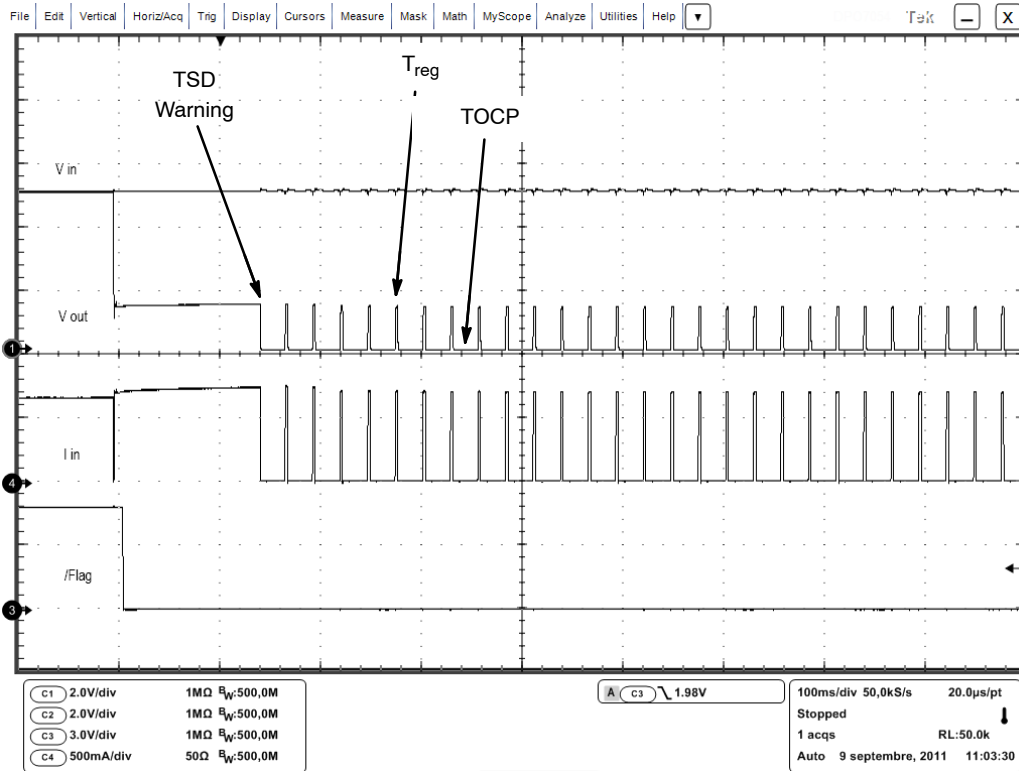
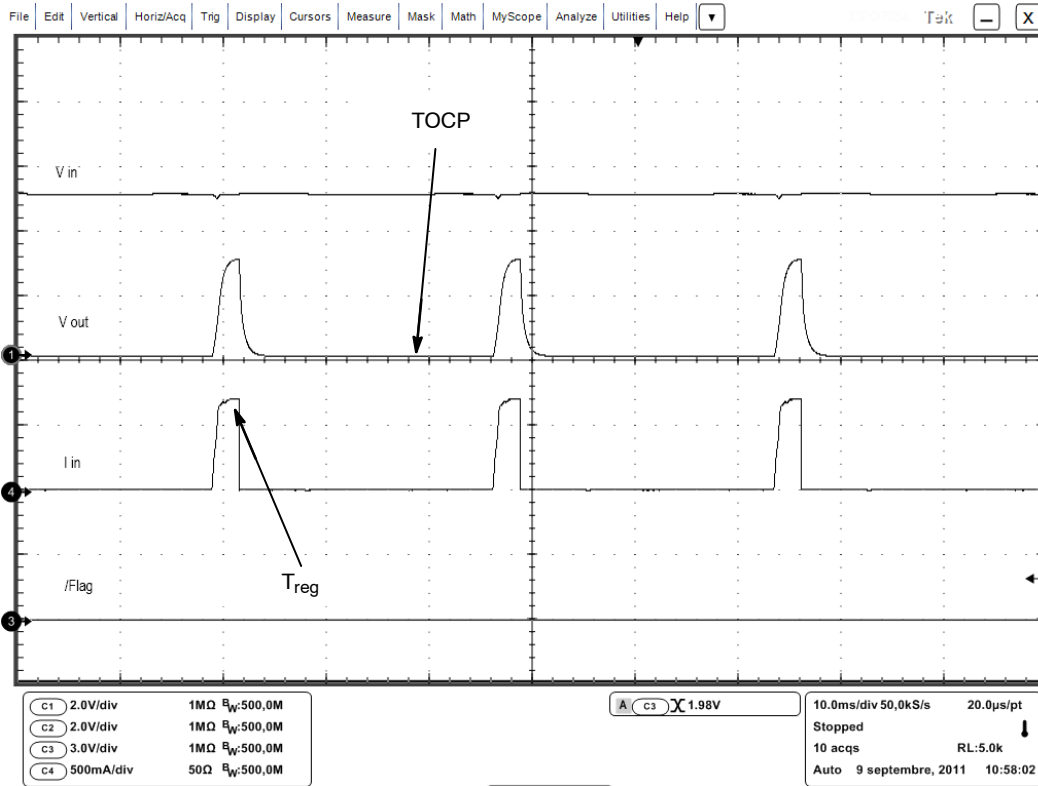
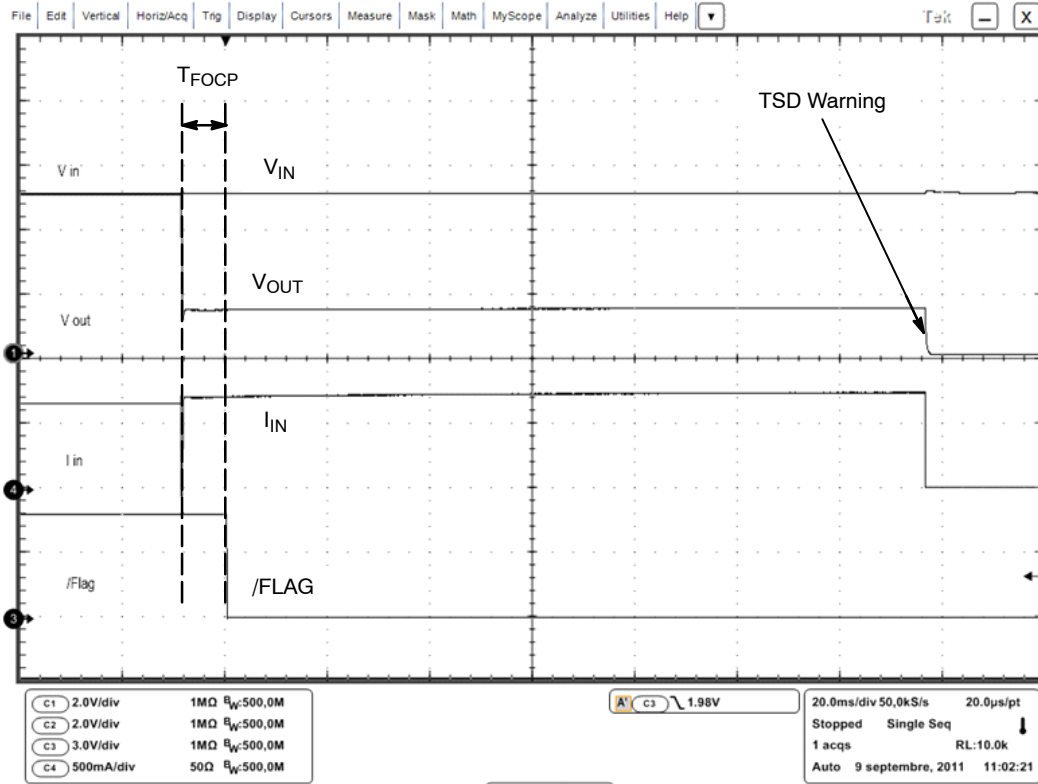

Figure 9. 2 Ω Short on Output. Complete Regulation Sequence

# NCP380, NCV380



# NCP380, NCV380

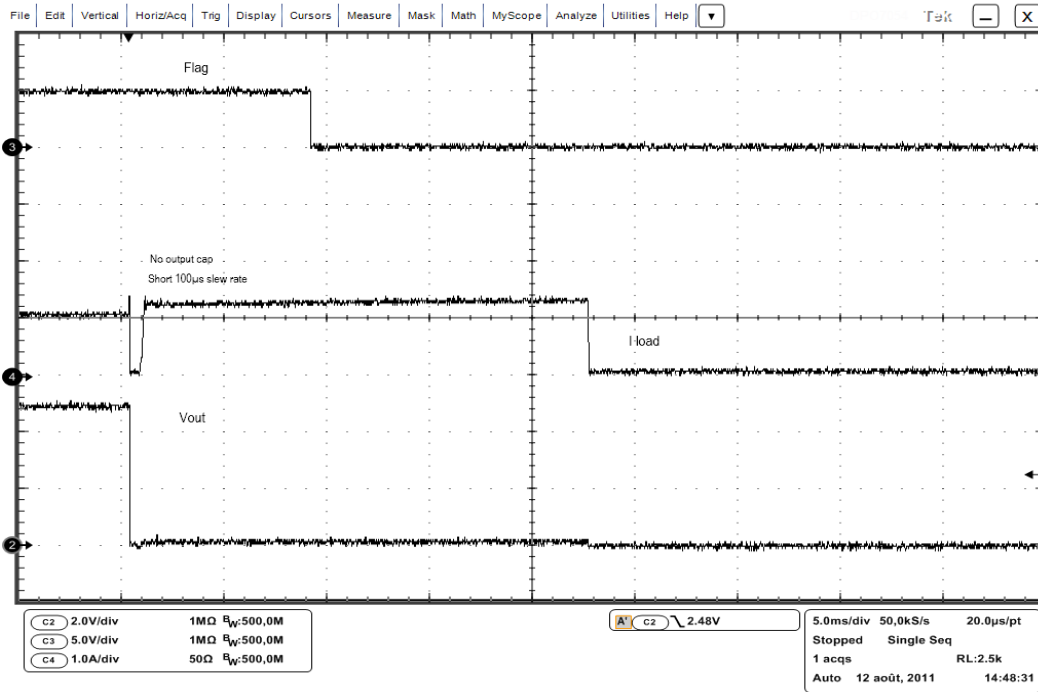

Figure 12. Direct Short on OUT Pin

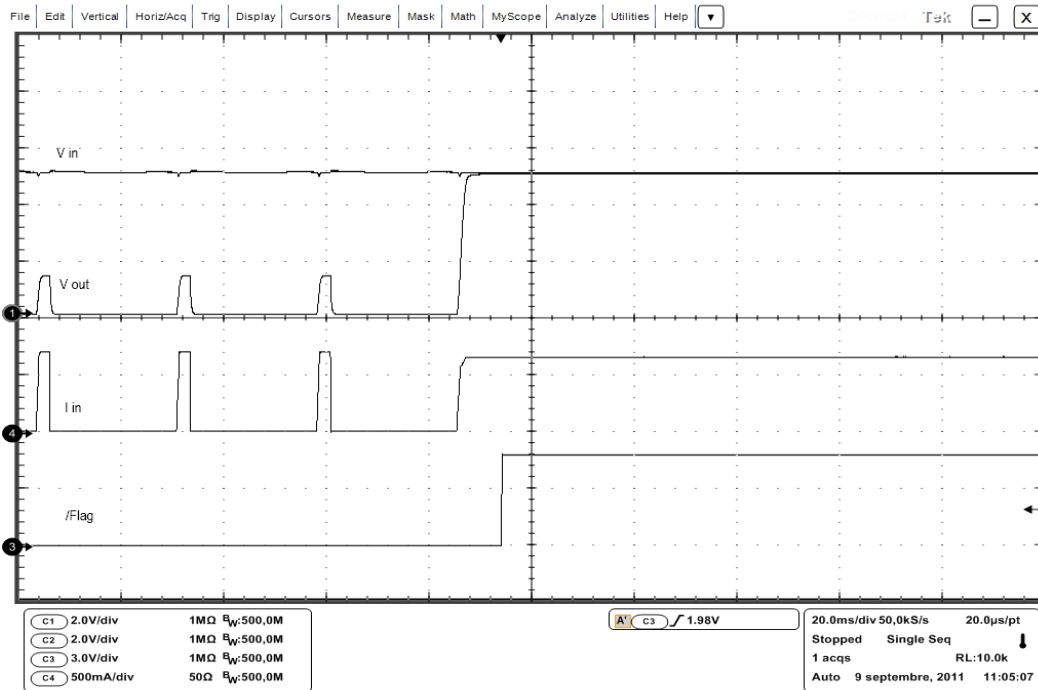

Figure 13. From Timer Regulation to Load Removal Sequence

# NCP380, NCV380

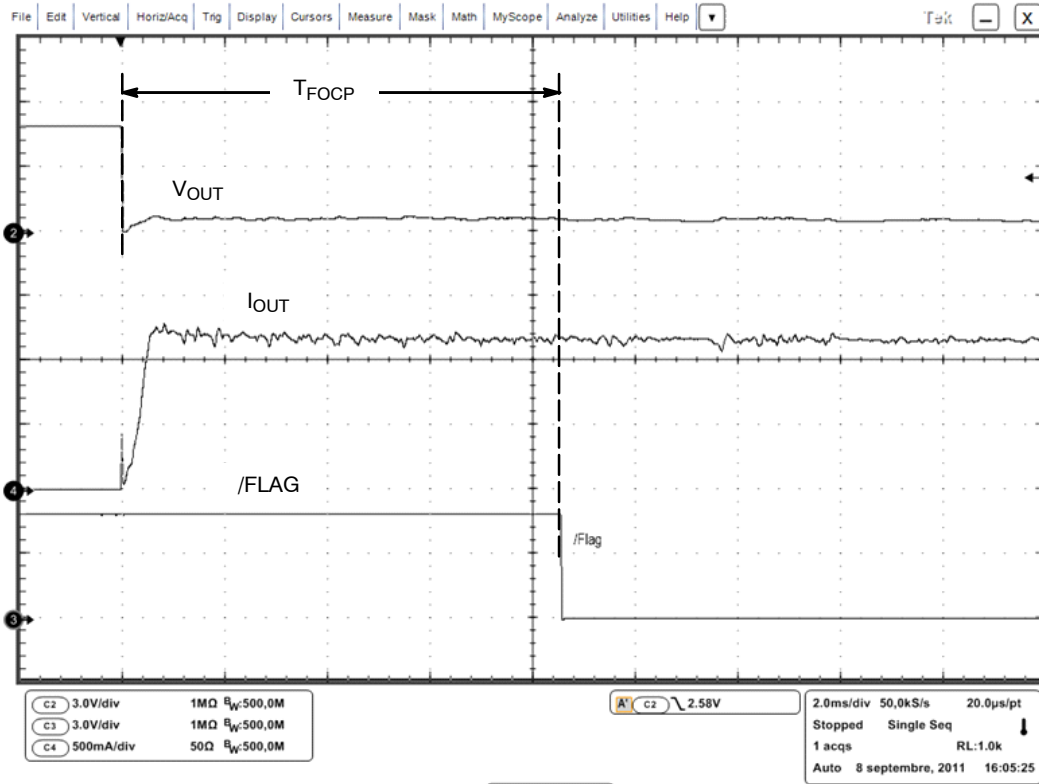

Figure 14. From No Load to Direct Short Circuit

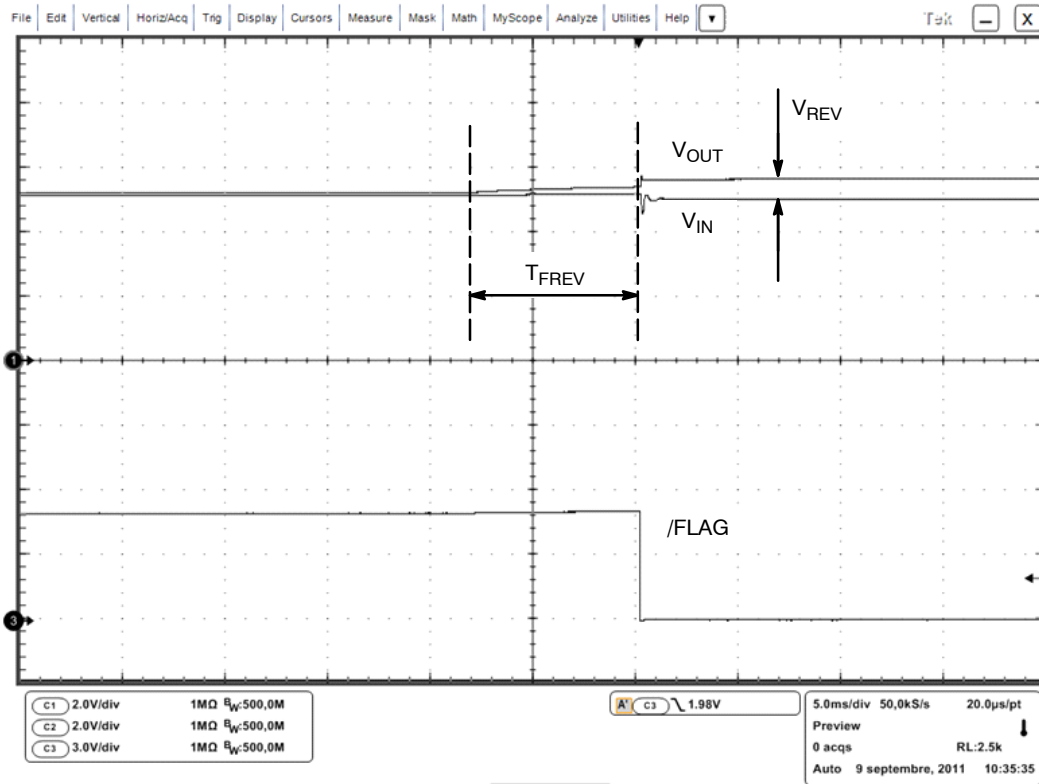

Figure 15. Reverse Voltage Detection

# NCP380, NCV380

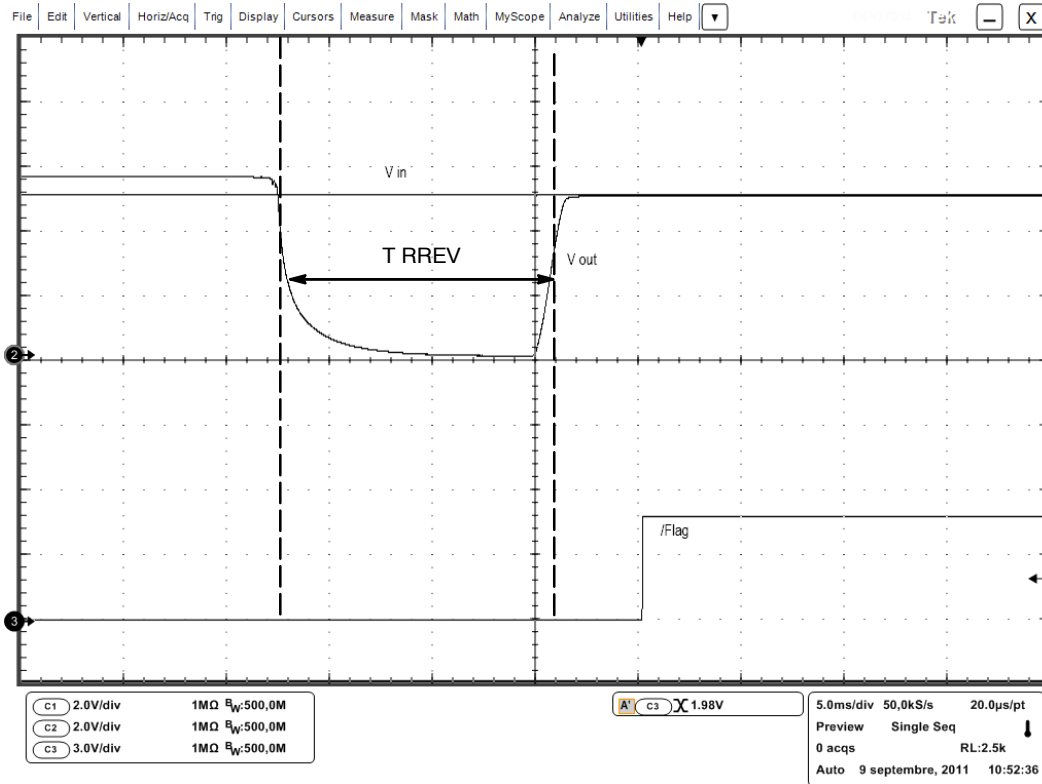

Figure 16. Reverse Voltage Removal

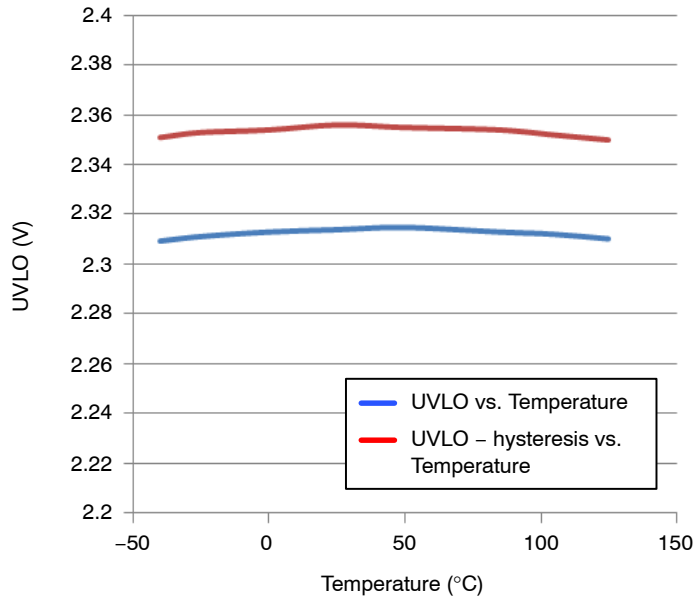

Figure 17. Undervoltage Threshold (Falling) and Hysteresis

# NCP380, NCV380

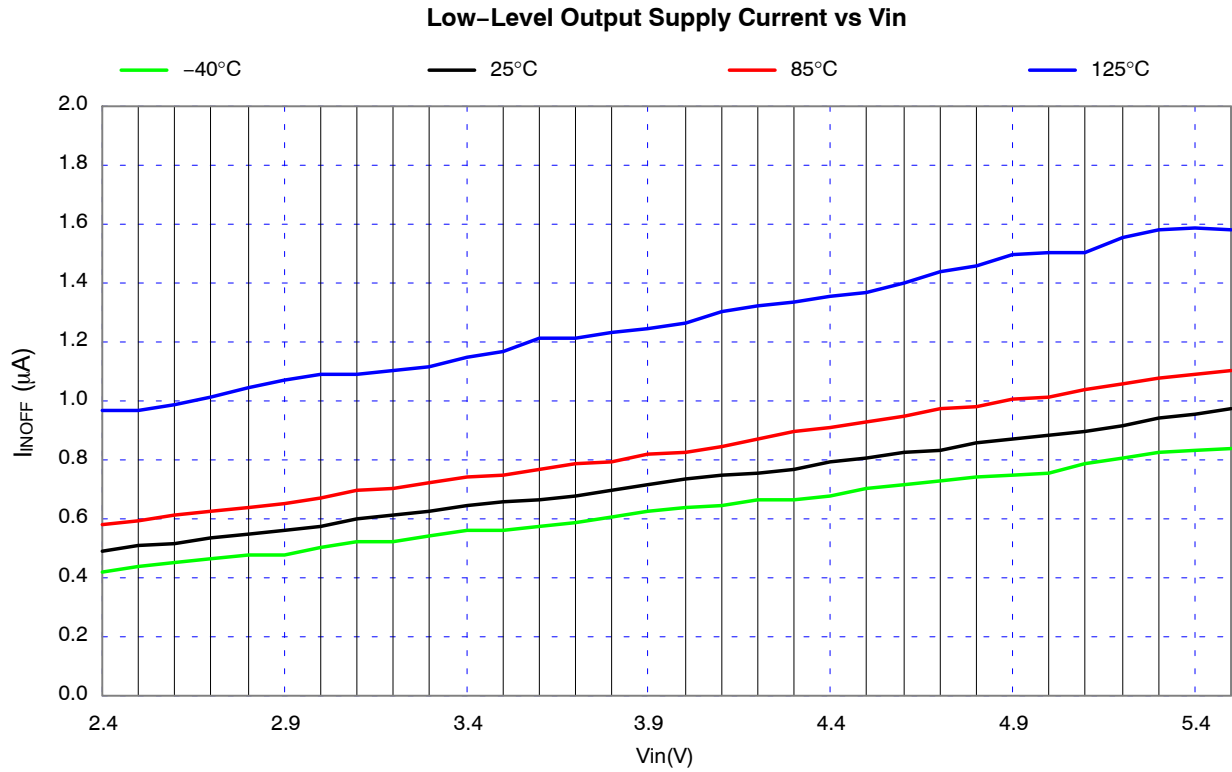

Figure 18. Standby Current vs Vin

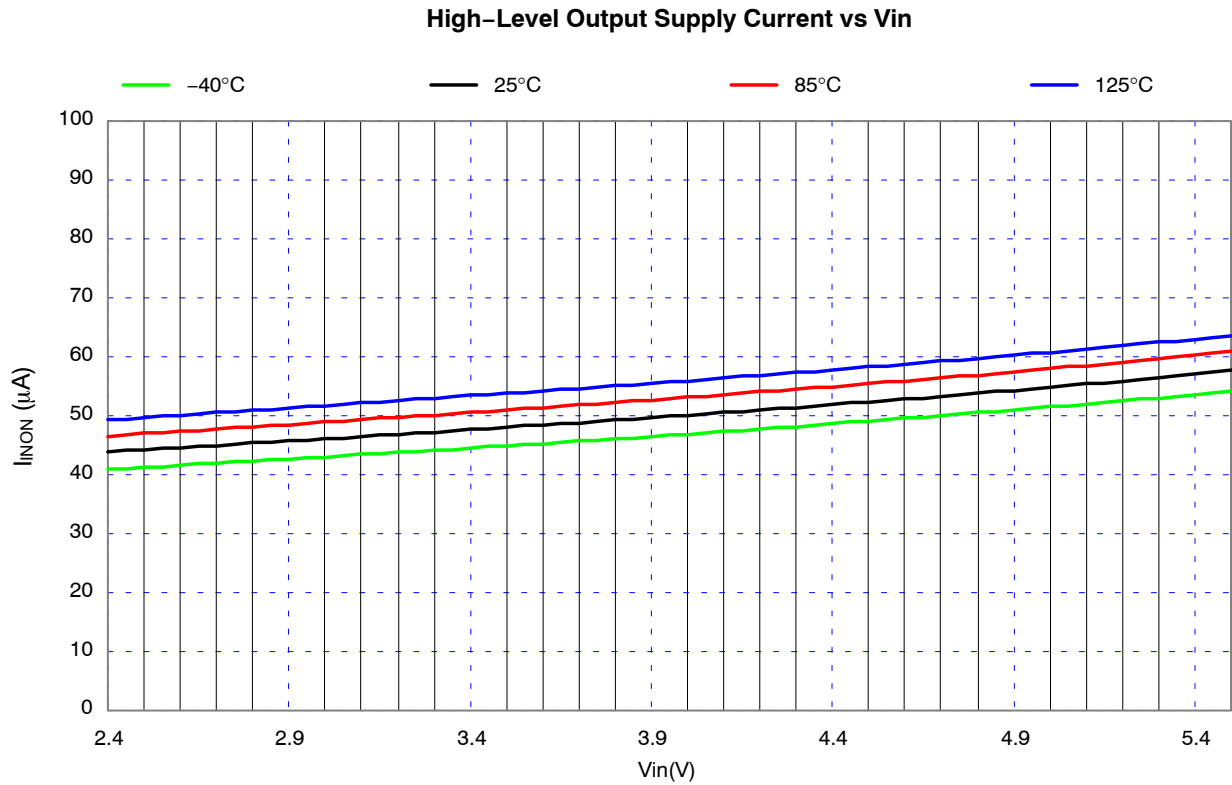

Figure 19. Quiescent Current vs Vin

# NCP380, NCV380

## TSOP Package

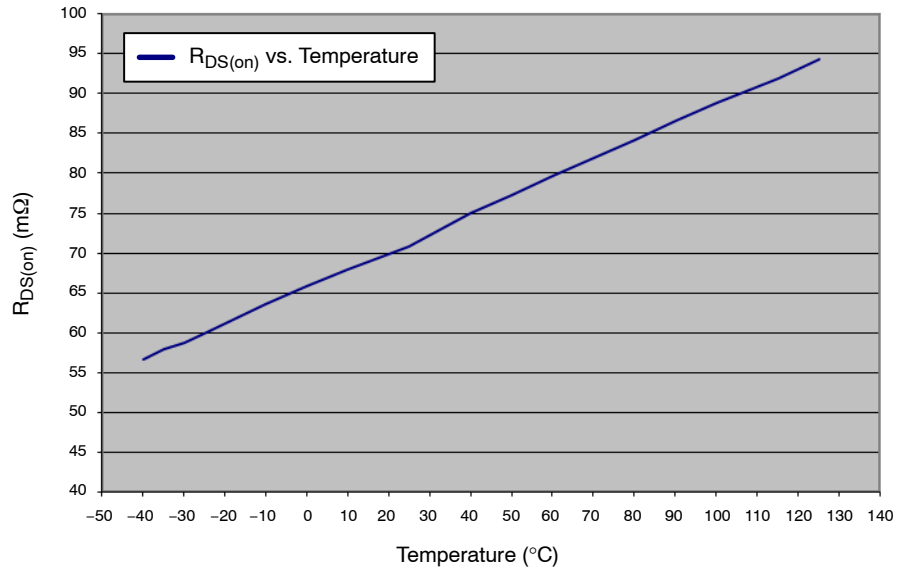

Figure 20. R<sub>DS(on)</sub> vs Temperature, TSOP Package

## μDFN Package

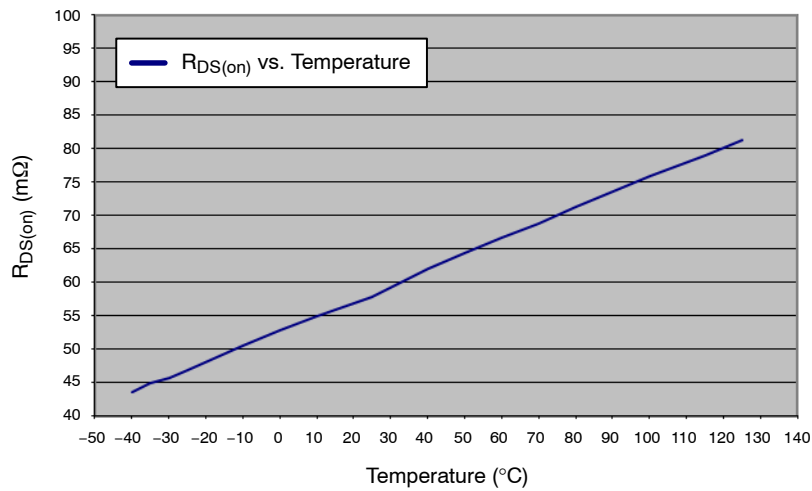

Figure 21. R<sub>DS(on)</sub> vs Temperature, μDFN Package

FUNCTIONAL DESCRIPTION

Overview

The NCP380 is a high side P channel MOSFET power distribution switch designed to protect the input supply voltage in case of heavy capacitive loads, short circuit or over current. In addition, the high side MOSFET is turned off during under voltage, thermal shutdown or reverse voltage condition. Adjustable version allows the user to program the current limit threshold using an external resistor. Thanks to the soft start circuitry, NCP380 is able to limit large current and voltage surges.

Overcurrent Protection

NCP380 switches into a constant current regulation mode when the output current is above the  $I_{OCP}$  threshold. Depending on the load, the output voltage is decreased accordingly.

- In case of hot plug with heavy capacitive load, the output voltage is brought down to the capacitor voltage. The NCP380 will limit the current to the  $I_{OCP}$  threshold value until the charge of the capacitor is completed.

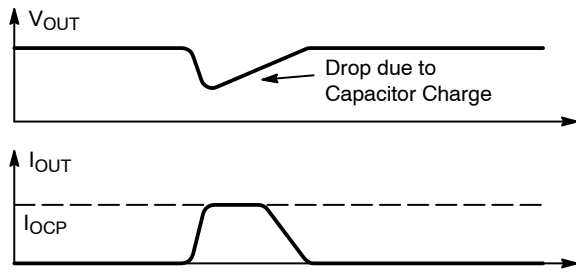

Figure 22. Heavy capacitive load

- In case of overload, the current is limited to the  $I_{OCP}$  value and the voltage value is reduced according to the load by the following relation:

$$V_{OUT} = R_{LOAD} \times I_{OCP} \quad (\text{eq. 1})$$

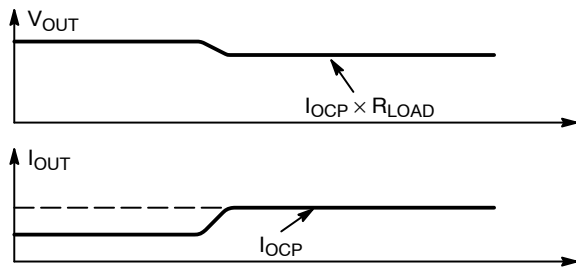

Figure 23. Overload

- In case of short circuit or huge load, the current is limited to the  $I_{OCP}$  value within  $T_{DET}$  time until the short condition is removed. If the output remains shorted or tied to a very low voltage, the junction temperature of the chip exceeds  $T_{SDOCP}$  value and the

device enters in thermal shutdown (MOSFET is turned-off).

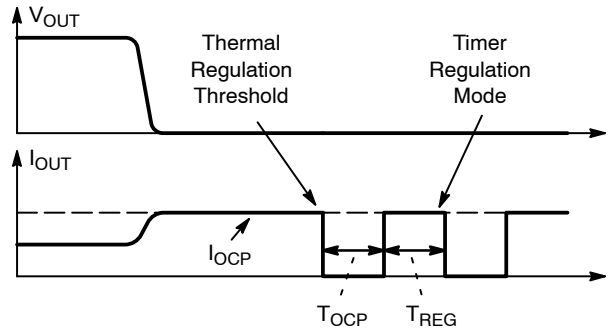

Figure 24. Short circuit

Then, the device enters in timer regulation mode, described in 2 phases:

- Off-phase: Power MOSFET is off during  $T_{OCP}$  to allow the die temperature to drop.
- On-phase: regulation current mode during  $T_{REG}$ . The current is regulated to the  $I_{OCP}$  level.

The timer regulation mode allows the device to handle high thermal dissipation (in case of short circuit for example) within temperature operating condition.

NCP380 stays in on-phase/off-phase loop until the over current condition is removed or enable pin is toggled.

**Remark:** Other regulation modes can be available for different applications. Please contact our **onsemi** representative for availability.

FLAG Indicator

The  $\overline{FLAG}$  pin is an open-drain MOSFET asserted low during over current, reverse-voltage or over temperature conditions. When an over current or a reverse voltage fault is detected on the power path,  $\overline{FLAG}$  pin is asserted low at the end of the associate deglitch time (see electrical characteristics). Thanks to this feature, the  $\overline{FLAG}$  pin is not tied low during the charge of a heavy capacitive load or a voltage transient on output. Deglitch time is  $T_{FOCP}$  for over current fault and  $T_{REV}$  for reverse voltage. The  $\overline{FLAG}$  pin remains low until the fault is removed. Then, the  $\overline{FLAG}$  pin goes high at the end of  $T_{FGL}$ .

Undervoltage Lock-out

Thanks to a built-in under voltage lockout (UVLO) circuitry, the output remains disconnected from input until  $V_{IN}$  voltage is below  $V_{UVLO}$ . When  $V_{IN}$  voltage is above  $V_{UVLO}$ , the system try to reconnect the output after a rearming time.  $T_{RUVLO}$ . This circuit has a  $V_{HYST}$  hysteresis witch provides noise immunity to transient.



# NCP380, NCV380

## Thermal Sense

Thermal shutdown turns off the power MOSFET if the die temperature exceeds  $T_{SD}$ . A Hysteresis prevents the part from turning on until the die temperature cools at  $T_{RSD}$ .

## Reverse Voltage Protection

When the output voltage exceeds the input voltage by  $V_{REV}$  voltage during  $T_{REV}$ , the reverse voltage circuitry disconnects the output in order to protect the power supply. The same time  $T_{REV}$  is needed to turn on again the power MOS plus a rearming time  $T_{RREV}$ .

## Enable Input

Enable pin must be driven by a logic signal (CMOS or TTL compatible) or connected to the GND.  $V_{IN}$  and EN should not be connected together directly.  $V_{IN}$  should be

well established and stabilized prior to enabling the IC. If no separate EN signal is available, a 10 k $\Omega$ /100 nF RC network can be added between  $V_{IN}$  and EN to delay the EN signal. A logic low on  $\overline{EN}$  or high on EN turns-on the device. A logic high on  $\overline{EN}$  or low on EN turns off device and reduces the current consumption down to  $I_{INOFF}$ .

## Blocking Control

The blocking control circuitry switches the bulk of the power MOS. When the part is off, the body diode limits the leakage current  $I_{REV}$  from OUT to IN. In this mode, anode of the body diode is connected to IN pin and cathode is connected to OUT pin. In operating condition, anode of the body diode is connected to OUT pin and cathode is connected to IN pin preventing the discharge of the power supply.

## APPLICATION INFORMATION

### Power Dissipation

The junction temperature of the device depends on different contributing factors such as board layout, ambient temperature, device environment, etc... Yet, the main contributor in terms of junction temperature is the power dissipation of the power MOSFET. Assuming this, the power dissipation and the junction temperature in normal mode can be calculated with the following equations:

$$P_D = R_{DS(on)} \times (I_{OUT})^2 \quad (\text{eq. 2})$$

Where:

$P_D$	= Power dissipation (W)
$R_{DS(on)}$	= Power MOSFET on resistance ( $\Omega$ )
$I_{OUT}$	= Output current (A)
$T_J = P_D \times R_{\theta JA} + T_A$	(eq. 3)

Where:

$T_J$	= Junction temperature ( $^{\circ}\text{C}$ )
$R_{\theta JA}$	= Package thermal resistance ( $^{\circ}\text{C}/\text{W}$ )
$T_A$	= Ambient temperature ( $^{\circ}\text{C}$ )

Power dissipation in regulation mode can be calculated by taking into account the drop  $V_{IN}-V_{OUT}$  link to the load by the following relation:

$$P_D = (V_{IN} - R_{LOAD} \times I_{OCP}) \times I_{OCP} \quad (\text{eq. 4})$$

Where:

$P_D$	= Power dissipation (W)
$V_{IN}$	= Input Voltage (V)
$R_{LOAD}$	= Load Resistance ( $\Omega$ )
$I_{OCP}$	= Output regulated current (A)

### Adjustable Current-Limit Programming (for adjustable version only)

The NCP380xMUAJAA and NCP380xSNAJAA, respectively  $\mu\text{DFN}$  and TSOP6 packages, are proposed to have current limit flexibility for end Customer. Indeed, Ilim pin is available to connect pull down resistor to ground, which participate to the current threshold adjustment. It's strongly recommended to use 0.1 or 1% resistor tolerance to keep the over current accuracy.

For this resistance selection, Customer should define first of all, the USB current to sustain, without the device enters in the protection sequence. Main rule is to select this pull down resistor in order to make sure min current limit is above the USB current to provide continuously to the upstream accessory.

Following, the main table selection contains the USB current port for the accessory, the standard resistor selection and typical/max over current threshold.

# NCP380, NCV380

**Table 5. RESISTOR SELECTION FOR ADJUSTABLE CURRENT LIMIT VERSION**

Min Current Limit Value (A)	Theoric Resistor Value (kΩ)	Selected Resistor Value (kΩ) 1% or 0.1%	Typical OCP Target Value (A)	Maximum Current Value (A)
0.5	44.2	44.2	0.59	0.67
0.6	37.5	37.4	0.71	0.81
0.7	32.2	31.6	0.825	0.95
0.8	27.7	27.4	0.94	1.08
0.9	24.0	23.7	1.06	1.22
1.0	21.0	21	1.18	1.35
1.1	18.5	18.2	1.3	1.49
1.2	16.6	16.5	1.41	1.62
1.3	14.6	14.3	1.53	1.76
1.4	13.0	13	1.65	1.9
1.5	11.4	11.3	1.78	2.05
1.6	10.4	10.2	1.88	2.17
1.7	9.2	9.09	2.01	2.31
1.8	8.3	8.25	2.12	2.438
1.9	7.4	7.32	2.23	2.56
2.0	6.5	6.49	2.36	2.7
2.1	5.6	5.49	2.48	2.85

The “Min current limit Value” column, represents the DC current to provide to the accessory without over current activation.

Second column is the theoretical resistor value obtained with following formula to achieve typical current target:

$$R_{lim} = -5.2959 \times ILIM^5 + 45.256 \times ILIM^4 - 155.25 \times ILIM^3 + 274.39 \times ILIM^2 - 267.6 \times ILIM + 134.21 \quad (\text{eq. 5})$$

**R<sub>LIM</sub> Versus OCP Average**

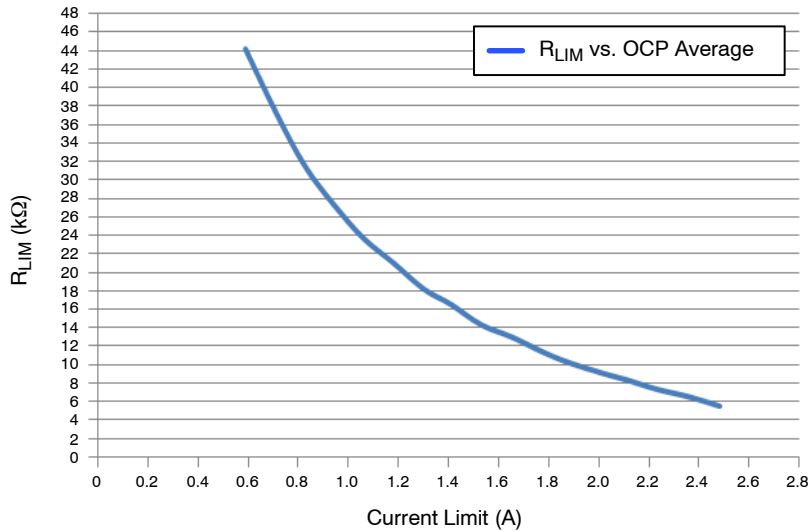

**Figure 25. R<sub>LIM</sub> Curve vs. Current Limit**

## NCP380, NCV380

When the resistor is choosing to fit with the Customer application, the limits of the over current threshold can be calculated with the following formula:

$$IOCP_{min} = 1.6915129 - 0.0330328 \times R_{lim} + 0.0011207(R_{lim} - 22.375)^2 - 0.0000451 \times (R_{lim} - 22.375)^3 + 0.0000009 \times (R_{lim} - 22.375)^4 \quad (\text{eq. 6})$$

$$IOCP_{max} = 2.2885175 - 0.0446914 \times R_{lim} + 0.0015163(R_{lim} - 22.375)^2 - 0.000061 \times (R_{lim} - 22.375)^3 + 0.0000012 \times (R_{lim} - 22.375)^4 \quad (\text{eq. 7})$$

$$IOCP_{typ} = 1.9900152 - 0.0388621 \times R_{lim} + 0.0013185(R_{lim} - 22.375)^2 - 0.0000531 \times (R_{lim} - 22.375)^3 + 0.0000011 \times (R_{lim} - 22.375)^4 \quad (\text{eq. 8})$$

The minimum, typical and maximum current curves are described in the following graph:

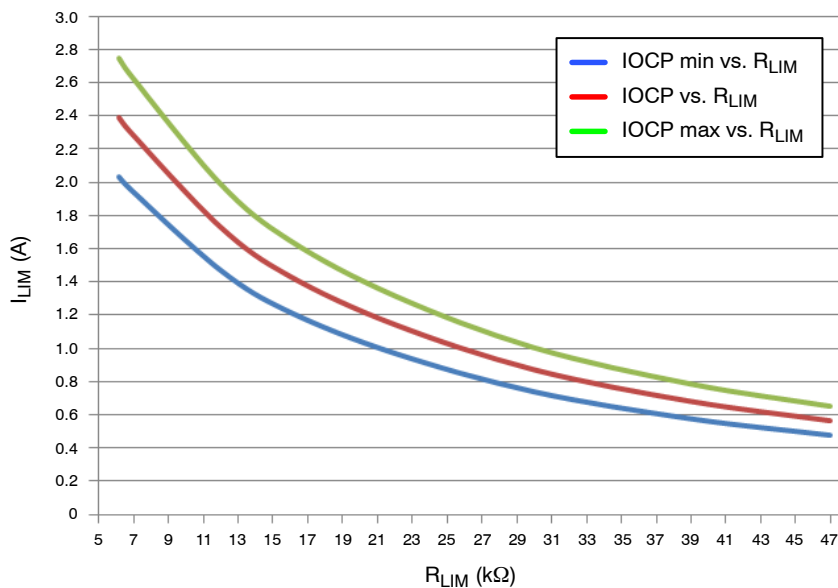

Figure 26. Current Threshold vs. Rlim Resistor

That is recommended to respect 6 kΩ–47 kΩ resistor range for two reasons.

For the low resistor values, the current limit is pushed up to high current level. Due to internal power dissipation capability, a maximum of 2.4 A typical can be set for the μDFN package if thermal consideration are respected. For the TSOP6 version 1.2 A is the maximum recommended value because the part could enter in thermal shutdown mode before constant current regulation mode.

In the other side, if we want to keep 15% of accuracy, high resistor values can be used up to 50 kΩ. With higher value, the current threshold is lower than 500 mA, so in this case degraded accuracy can be observed.

### PCB Recommendations

The NCP380 integrates a PMOS FET rated up to 2 A, and the PCB design rules must be respected to properly evacuate the heat out of the silicon. The UDFN6 PAD1 must be connected to ground plane to increase the heat transfer if necessary. This pad must be connected to ground plane. By increasing PCB area, the R<sub>θJA</sub> of the package can be decreased, allowing higher power dissipation.

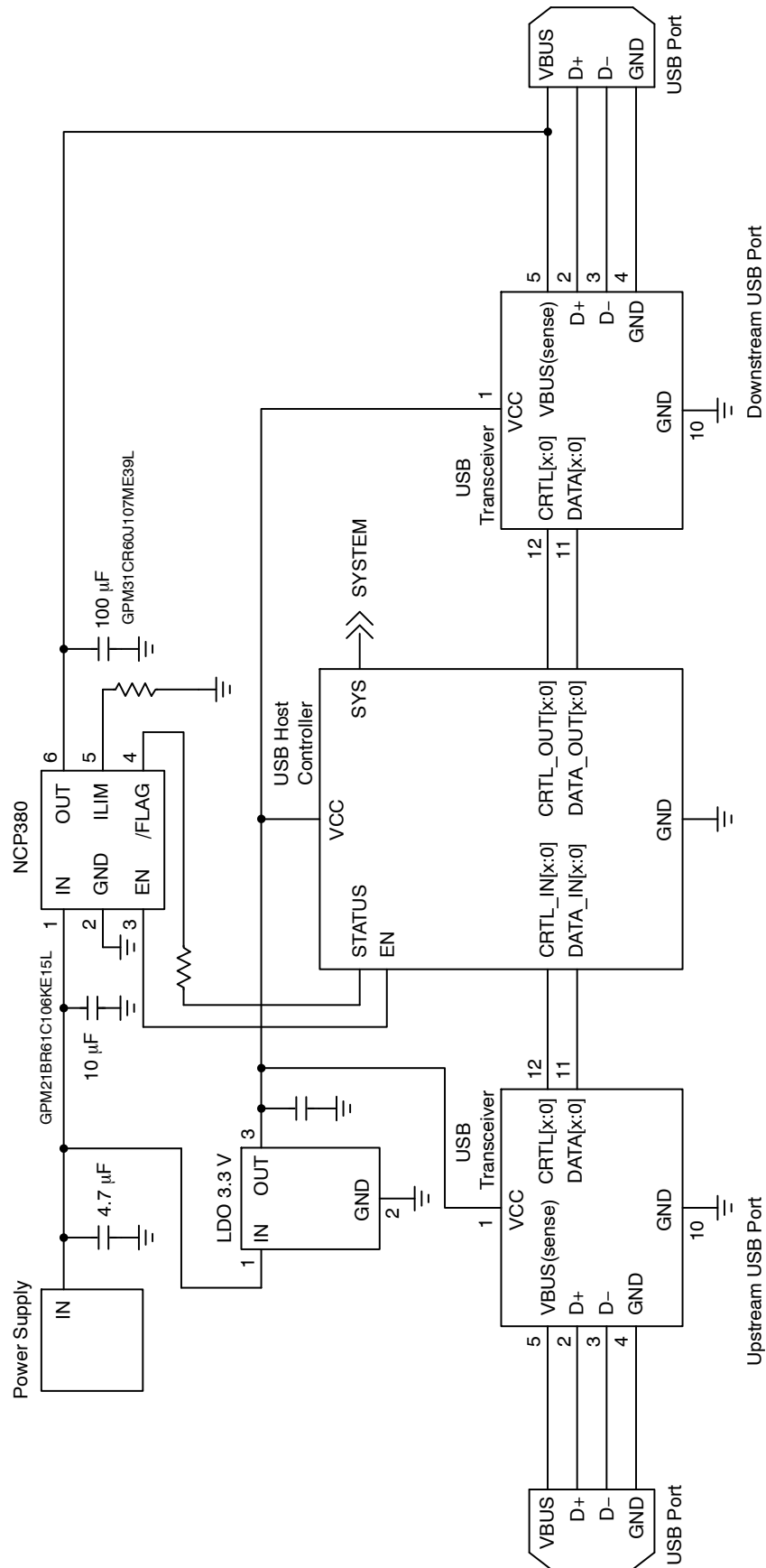

Figure 27. USB Host Typical Application

## NCP380, NCV380

**Table 6. ORDERING INFORMATION**

Device	Marking	Active Enable Level	Over Current Limit	Evaluation Board	UL Listed	CB Scheme	Package	Shipping <sup>†</sup>
NCP380LSNAJAAT1G	AAC	Low	Adj.	NCP380LSNAJAGEVB	Y	Y	TSOP-6 (Pb-Free)	3,000 Tape / Reel
NCP380LSN05AAT1G	AC5		0.5 A	NCP380LSN05AGEVB	Y	Y	TSOP-5 (Pb-Free)	
NCP380LSN10AAT1G	AC6		1.0 A	NCP380LSN10AGEVB	Y	Y	UDFN6 (Pb-Free)	
NCP380LMUJAATBG	AA		Adj.	NCP380LMUJAGEVB	Y	Y		
NCV380LMUJAATBG*	AN		Adj.	NCP380LMUJAGEVB	N	N		
NCP380LMU05AATBG	AE		0.5 A	NCP380LMU05AGEVB	Y	Y		
NCP380HSNAJAAT1G	AAD	High	Adj.	NCP380HSNAJAGEVB	Y	Y	TSOP-6 (Pb-Free)	
NCP380HSN05AAT1G	AC7		0.5 A	NCP380HSN05AGEVB	Y	Y	TSOP-5 (Pb-Free)	
NCP380HSN10AAT1G	ADA		1.0 A	NCP380HSN10AGEVB	Y	Y	UDFN6 (Pb-Free)	
NCP380HMUAJAATBG	AC		Adj.	NCP380HMUAJAGEVB	Y	Y		
NCV380HMUAJAATBG*	AP		Adj.	NCP380HMUAJAGEVB	N	N		
NCP380HMU05AATBG	AH		0.5 A	NCP380HMU05AGEVB	Y	Y		
NCP380HMU10AATBG	AJ		1.0 A	NCP380HMU10AGEVB	Y	Y		
NCP380HMU15AATBG	AK		1.5 A	NCP380HMU15AGEVB	Y	Y		
NCP380HMU20AATBG	AM		2.0 A	NCP380HMU20AGEVB	Y	Y		
NCP380HMU21AATBG	AU		2.1 A	NCP380HMU21AGEVB	Y	Y		

<sup>†</sup>For information on tape and reel specifications, including part orientation and tape sizes, please refer to our Tape and Reel Packaging Specifications Brochure, BRD8011/D.

\*NCV Prefix for Automotive and Other Applications Requiring Unique Site and Control Change Requirements; AEC-Q100 Qualified and PPAP Capable

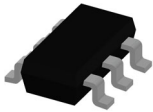

**TSOP-6 3.00x1.50x0.90, 0.95P**  
**CASE 318G**  
**ISSUE W**

DATE 26 FEB 2024

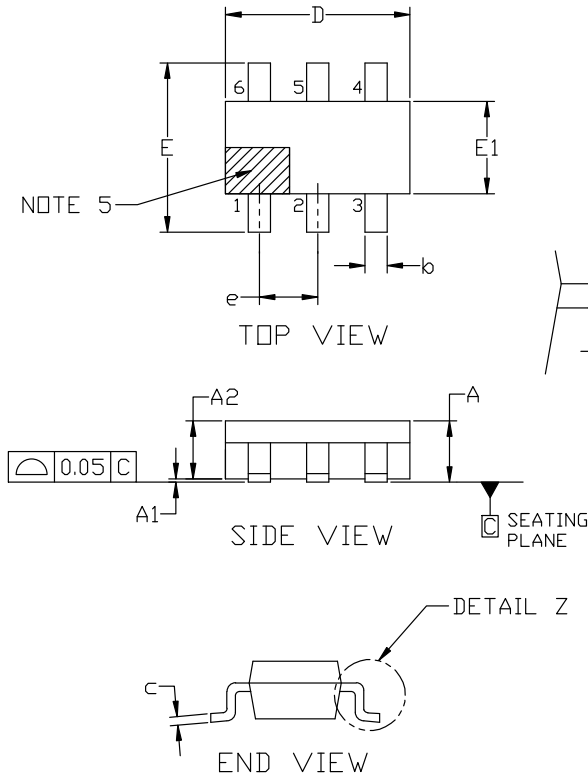

NOTES:

1. DIMENSIONING AND TOLERANCING PER ASME Y14.5M, 2018.
2. CONTROLLING DIMENSION: MILLIMETERS.
3. MAXIMUM LEAD THICKNESS INCLUDES LEAD FINISH. MINIMUM LEAD THICKNESS IS THE MINIMUM THICKNESS OF BASE MATERIAL.
4. DIMENSIONS D AND E1 DO NOT INCLUDE MOLD FLASH, PROTRUSIONS, OR GATE BURRS. MOLD FLASH, PROTRUSIONS, OR GATE BURRS SHALL NOT EXCEED 0.15 PER SIDE. DIMENSIONS D AND E1 ARE DETERMINED AT DATUM H.
5. PIN 1 INDICATOR MUST BE LOCATED IN THE INDICATED ZONE

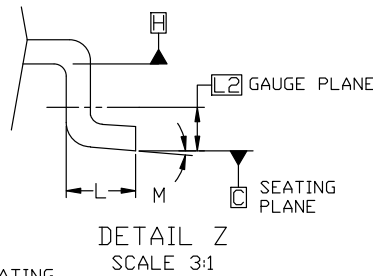

MILLIMETERS			
DIM	MIN	NOM	MAX
A	0.90	1.00	1.10
A1	0.01	0.06	0.10
A2	0.80	0.90	1.00
b	0.25	0.38	0.50
c	0.10	0.18	0.26
D	2.90	3.00	3.10
E	2.50	2.75	3.00
E1	1.30	1.50	1.70
e	0.85	0.95	1.05
L	0.20	0.40	0.60
L2	0.25 BSC		
M	0°	---	10°

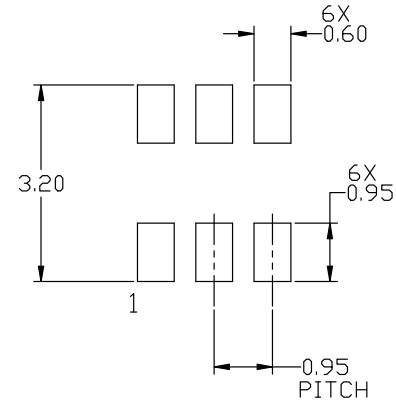

RECOMMENDED MOUNTING FOOTPRINT

\*For additional information on our Pb-Free strategy and soldering details, please download the ON Semiconductor Soldering and Mounting Techniques Reference manual, SOLDERRM/D.

<b>DOCUMENT NUMBER:</b>	<b>98ASB14888C</b>	Electronic versions are uncontrolled except when accessed directly from the Document Repository. Printed versions are uncontrolled except when stamped "CONTROLLED COPY" in red.
<b>DESCRIPTION:</b>	<b>TSOP-6 3.00x1.50x0.90, 0.95P</b>	<b>PAGE 1 OF 2</b>

onsemi and ONSEMI are trademarks of Semiconductor Components Industries, LLC dba onsemi or its subsidiaries in the United States and/or other countries. onsemi reserves the right to make changes without further notice to any products herein. onsemi makes no warranty, representation or guarantee regarding the suitability of its products for any particular purpose, nor does onsemi assume any liability arising out of the application or use of any product or circuit, and specifically disclaims any and all liability, including without limitation special, consequential or incidental damages. onsemi does not convey any license under its patent rights nor the rights of others.

**TSOP-6 3.00x1.50x0.90, 0.95P**  
**CASE 318G**  
**ISSUE W**

DATE 26 FEB 2024

**GENERIC  
MARKING DIAGRAM\***

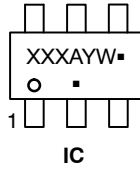

**IC**

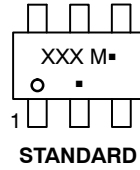

**STANDARD**

XXX = Specific Device Code    XXX = Specific Device Code  
A = Assembly Location        M = Date Code  
Y = Year                        ■ = Pb-Free Package  
W = Work Week  
■ = Pb-Free Package

\*This information is generic. Please refer to device data sheet for actual part marking. Pb-Free indicator, "G" or microdot "■", may or may not be present. Some products may not follow the Generic Marking.

- |   |   |  |  |  |   |
|---|---|--|--|--|---|
| <p><b>STYLE 1:</b><br/> PIN 1. DRAIN<br/> 2. DRAIN<br/> 3. GATE<br/> 4. SOURCE<br/> 5. DRAIN<br/> 6. DRAIN</p>              | <p><b>STYLE 2:</b><br/> PIN 1. EMITTER 2<br/> 2. BASE 1<br/> 3. COLLECTOR 1<br/> 4. EMITTER 1<br/> 5. BASE 2<br/> 6. COLLECTOR 2</p>    | <p><b>STYLE 3:</b><br/> PIN 1. ENABLE<br/> 2. N/C<br/> 3. R BOOST<br/> 4. Vz<br/> 5. V in<br/> 6. V out</p>                            | <p><b>STYLE 4:</b><br/> PIN 1. N/C<br/> 2. V in<br/> 3. NOT USED<br/> 4. GROUND<br/> 5. ENABLE<br/> 6. LOAD</p>                | <p><b>STYLE 5:</b><br/> PIN 1. EMITTER 2<br/> 2. BASE 2<br/> 3. COLLECTOR 1<br/> 4. EMITTER 1<br/> 5. BASE 1<br/> 6. COLLECTOR 2</p> | <p><b>STYLE 6:</b><br/> PIN 1. COLLECTOR<br/> 2. COLLECTOR<br/> 3. BASE<br/> 4. EMITTER<br/> 5. COLLECTOR<br/> 6. COLLECTOR</p> |
| <p><b>STYLE 7:</b><br/> PIN 1. COLLECTOR<br/> 2. COLLECTOR<br/> 3. BASE<br/> 4. N/C<br/> 5. COLLECTOR<br/> 6. EMITTER</p>   | <p><b>STYLE 8:</b><br/> PIN 1. Vbus<br/> 2. D(in)<br/> 3. D(in)+<br/> 4. D(out)+<br/> 5. D(out)<br/> 6. GND</p>                         | <p><b>STYLE 9:</b><br/> PIN 1. LOW VOLTAGE GATE<br/> 2. DRAIN<br/> 3. SOURCE<br/> 4. DRAIN<br/> 5. DRAIN<br/> 6. HIGH VOLTAGE GATE</p> | <p><b>STYLE 10:</b><br/> PIN 1. D(OUT)+<br/> 2. GND<br/> 3. D(OUT)-<br/> 4. D(IN)-<br/> 5. VBUS<br/> 6. D(IN)+</p>             | <p><b>STYLE 11:</b><br/> PIN 1. SOURCE 1<br/> 2. DRAIN 2<br/> 3. DRAIN 2<br/> 4. SOURCE 2<br/> 5. GATE 1<br/> 6. DRAIN 1/GATE 2</p>  | <p><b>STYLE 12:</b><br/> PIN 1. I/O<br/> 2. GROUND<br/> 3. I/O<br/> 4. I/O<br/> 5. VCC<br/> 6. I/O</p>                          |
| <p><b>STYLE 13:</b><br/> PIN 1. GATE 1<br/> 2. SOURCE 2<br/> 3. GATE 2<br/> 4. DRAIN 2<br/> 5. SOURCE 1<br/> 6. DRAIN 1</p> | <p><b>STYLE 14:</b><br/> PIN 1. ANODE<br/> 2. SOURCE<br/> 3. GATE<br/> 4. CATHODE/DRAIN<br/> 5. CATHODE/DRAIN<br/> 6. CATHODE/DRAIN</p> | <p><b>STYLE 15:</b><br/> PIN 1. ANODE<br/> 2. SOURCE<br/> 3. GATE<br/> 4. DRAIN<br/> 5. N/C<br/> 6. CATHODE</p>                        | <p><b>STYLE 16:</b><br/> PIN 1. ANODE/CATHODE<br/> 2. BASE<br/> 3. EMITTER<br/> 4. COLLECTOR<br/> 5. ANODE<br/> 6. CATHODE</p> | <p><b>STYLE 17:</b><br/> PIN 1. EMITTER<br/> 2. BASE<br/> 3. ANODE/CATHODE<br/> 4. ANODE<br/> 5. CATHODE<br/> 6. COLLECTOR</p>       |   |

<b>DOCUMENT NUMBER:</b>	<b>98ASB14888C</b>	Electronic versions are uncontrolled except when accessed directly from the Document Repository. Printed versions are uncontrolled except when stamped "CONTROLLED COPY" in red.
<b>DESCRIPTION:</b>	<b>TSOP-6 3.00x1.50x0.90, 0.95P</b>	<b>PAGE 2 OF 2</b>

**onsemi** and **ONSEMI** are trademarks of Semiconductor Components Industries, LLC dba **onsemi** or its subsidiaries in the United States and/or other countries. **onsemi** reserves the right to make changes without further notice to any products herein. **onsemi** makes no warranty, representation or guarantee regarding the suitability of its products for any particular purpose, nor does **onsemi** assume any liability arising out of the application or use of any product or circuit, and specifically disclaims any and all liability, including without limitation special, consequential or incidental damages. **onsemi** does not convey any license under its patent rights nor the rights of others.

# MECHANICAL CASE OUTLINE PACKAGE DIMENSIONS

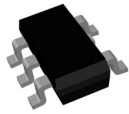

## TSOP-5 3.00x1.50x0.95, 0.95P CASE 483 ISSUE P

DATE 01 APR 2024

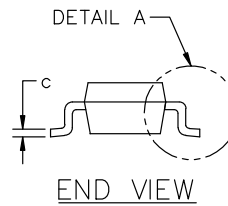
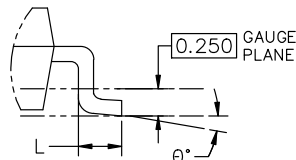

NOTES:

1. DIMENSIONING AND TOLERANCING CONFORM TO ASME Y14.5-2018.
2. ALL DIMENSION ARE IN MILLIMETERS (ANGLES IN DEGREES).
3. MAXIMUM LEAD THICKNESS INCLUDES LEAD FINISH THICKNESS. MINIMUM LEAD THICKNESS IS THE MINIMUM THICKNESS OF BASE MATERIAL.
4. DIMENSIONS D AND E1 DO NOT INCLUDE MOLD FLASH, PROTRUSIONS OF GATE BURRS. MOLD FLASH, PROTRUSIONS, OR GATE BURRS SHALL NOT EXCEED 0.15 PER SIDE. DIMENSION D.
5. OPTIONAL CONSTRUCTION: AN ADDITIONAL TRIMMED LEAD IS ALLOWED IN THIS LOCATION. TRIMMED LEAD NOT TO EXTEND MORE THAN 0.2 FROM BODY.

DIM	MILLIMETERS		
	MIN.	NOM.	MAX.
A	0.900	1.000	1.100
A1	0.010	0.055	0.100
A2	0.950 REF.		
b	0.250	0.375	0.500
c	0.100	0.180	0.260
D	2.850	3.000	3.150
E	2.500	2.750	3.000
E1	1.350	1.500	1.650
e	0.950 BSC		
L	0.200	0.400	0.600
$\theta$	0°	5°	10°

### GENERIC MARKING DIAGRAM\*

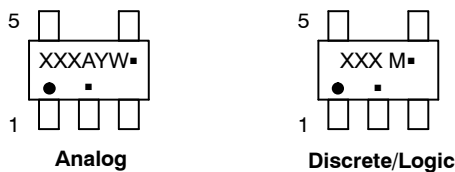

- XXX = Specific Device Code    XXX = Specific Device Code  
 A = Assembly Location        M = Date Code  
 Y = Year                        ■ = Pb-Free Package  
 W = Work Week

■ = Pb-Free Package  
(Note: Microdot may be in either location)

\*This information is generic. Please refer to device data sheet for actual part marking. Pb-Free indicator, "G" or microdot "■", may or may not be present. Some products may not follow the Generic Marking.

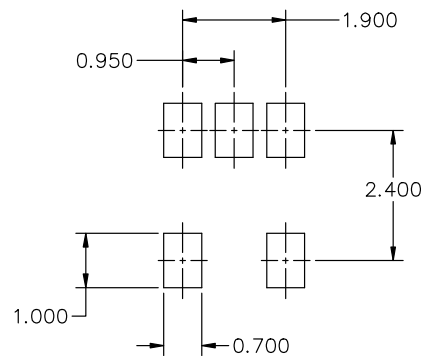

\* FOR ADDITIONAL INFORMATION ON OUR Pb-FREE STRATEGY AND SOLDERING DETAILS, PLEASE DOWNLOAD THE ON SEMICONDUCTOR SOLDERING AND MOUNTING TECHNIQUES REFERENCE MANUAL, SOLDERM/D.

DOCUMENT NUMBER:	98ARB18753C	Electronic versions are uncontrolled except when accessed directly from the Document Repository. Printed versions are uncontrolled except when stamped "CONTROLLED COPY" in red.
DESCRIPTION:	TSOP-5 3.00x1.50x0.95, 0.95P	PAGE 1 OF 1

onsemi and ONSEMI are trademarks of Semiconductor Components Industries, LLC dba onsemi or its subsidiaries in the United States and/or other countries. onsemi reserves the right to make changes without further notice to any products herein. onsemi makes no warranty, representation or guarantee regarding the suitability of its products for any particular purpose, nor does onsemi assume any liability arising out of the application or use of any product or circuit, and specifically disclaims any and all liability, including without limitation special, consequential or incidental damages. onsemi does not convey any license under its patent rights nor the rights of others.



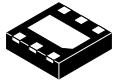

SCALE 4:1

UDFN6 2x2, 0.65P  
CASE 517AB  
ISSUE C

DATE 10 APR 2013

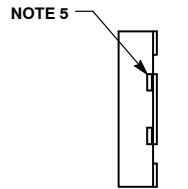
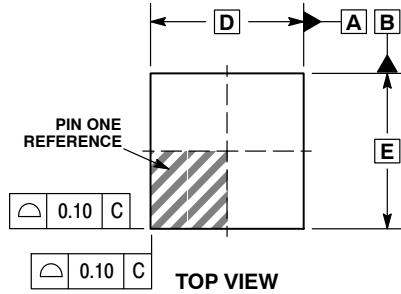

NOTES:

1. DIMENSIONING AND TOLERANCING PER ASME Y14.5M, 1994.
2. CONTROLLING DIMENSION: MILLIMETERS.
3. DIMENSION b APPLIES TO PLATED TERMINAL AND IS MEASURED BETWEEN 0.15 AND 0.25MM FROM THE TERMINAL TIP.
4. COPLANARITY APPLIES TO THE EXPOSED PAD AS WELL AS THE TERMINALS.
5. TIE BARS MAY BE VISIBLE IN THIS VIEW AND ARE CONNECTED TO THE THERMAL PAD.

DIM	MILLIMETERS	
	MIN	MAX
A	0.45	0.55
A1	0.00	0.05
A3	0.127 REF	
b	0.25	0.35
D	2.00 BSC	
D2	1.50	1.70
E	2.00 BSC	
E2	0.80	1.00
e	0.65 BSC	
L	0.25	0.35
L1	---	0.15

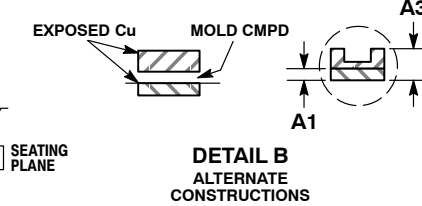
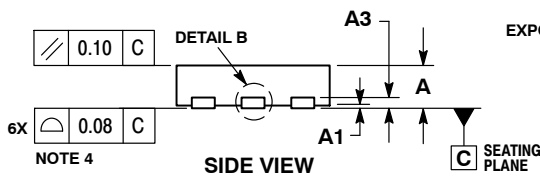

**GENERIC  
MARKING DIAGRAM\***



- XX = Specific Device Code
- M = Date Code
- = Pb-Free Package

(Note: Microdot may be in either location)

\*This information is generic. Please refer to device data sheet for actual part marking. Pb-Free indicator, "G" or microdot "▪", may or may not be present.

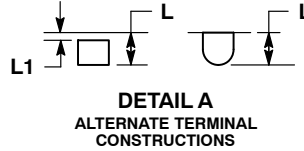
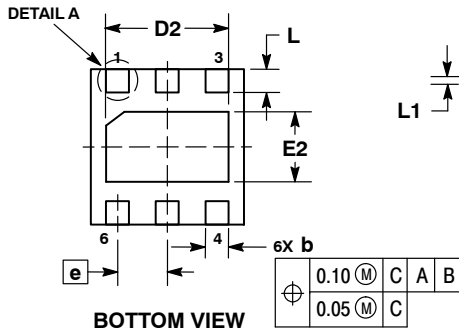

**RECOMMENDED  
SOLDERING FOOTPRINT\***

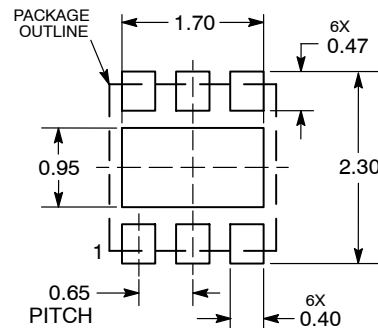

DIMENSIONS: MILLIMETERS

\*For additional information on our Pb-Free strategy and soldering details, please download the onsemi Soldering and Mounting Techniques Reference Manual, SOLDERRM/D.

<b>DOCUMENT NUMBER:</b>	<b>98AON22162D</b>	Electronic versions are uncontrolled except when accessed directly from the Document Repository. Printed versions are uncontrolled except when stamped "CONTROLLED COPY" in red.
<b>DESCRIPTION:</b>	<b>UDFN6 2X2, 0.65P</b>	<b>PAGE 1 OF 1</b>

onsemi and ONSEMI are trademarks of Semiconductor Components Industries, LLC dba onsemi or its subsidiaries in the United States and/or other countries. onsemi reserves the right to make changes without further notice to any products herein. onsemi makes no warranty, representation or guarantee regarding the suitability of its products for any particular purpose, nor does onsemi assume any liability arising out of the application or use of any product or circuit, and specifically disclaims any and all liability, including without limitation special, consequential or incidental damages. onsemi does not convey any license under its patent rights nor the rights of others.

**onsemi**, **Onsemi**, and other names, marks, and brands are registered and/or common law trademarks of Semiconductor Components Industries, LLC dba "**onsemi**" or its affiliates and/or subsidiaries in the United States and/or other countries. **onsemi** owns the rights to a number of patents, trademarks, copyrights, trade secrets, and other intellectual property. A listing of **onsemi**'s product/patent coverage may be accessed at [www.onsemi.com/site/pdf/Patent-Marking.pdf](http://www.onsemi.com/site/pdf/Patent-Marking.pdf). **onsemi** reserves the right to make changes at any time to any products or information herein, without notice. The information herein is provided "as-is" and **onsemi** makes no warranty, representation or guarantee regarding the accuracy of the information, product features, availability, functionality, or suitability of its products for any particular purpose, nor does **onsemi** assume any liability arising out of the application or use of any product or circuit, and specifically disclaims any and all liability, including without limitation special, consequential or incidental damages. Buyer is responsible for its products and applications using **onsemi** products, including compliance with all laws, regulations and safety requirements or standards, regardless of any support or applications information provided by **onsemi**. "Typical" parameters which may be provided in **onsemi** data sheets and/or specifications can and do vary in different applications and actual performance may vary over time. All operating parameters, including "Typicals" must be validated for each customer application by customer's technical experts. **onsemi** does not convey any license under any of its intellectual property rights nor the rights of others. **onsemi** products are not designed, intended, or authorized for use as a critical component in life support systems or any FDA Class 3 medical devices or medical devices with a same or similar classification in a foreign jurisdiction or any devices intended for implantation in the human body. Should Buyer purchase or use **onsemi** products for any such unintended or unauthorized application, Buyer shall indemnify and hold **onsemi** and its officers, employees, subsidiaries, affiliates, and distributors harmless against all claims, costs, damages, and expenses, and reasonable attorney fees arising out of, directly or indirectly, any claim of personal injury or death associated with such unintended or unauthorized use, even if such claim alleges that **onsemi** was negligent regarding the design or manufacture of the part. **onsemi** is an Equal Opportunity/Affirmative Action Employer. This literature is subject to all applicable copyright laws and is not for resale in any manner.

## ADDITIONAL INFORMATION

### TECHNICAL PUBLICATIONS:

Technical Library: [www.onsemi.com/design/resources/technical-documentation](http://www.onsemi.com/design/resources/technical-documentation)  
onsemi Website: [www.onsemi.com](http://www.onsemi.com)

### ONLINE SUPPORT: [www.onsemi.com/support](http://www.onsemi.com/support)

For additional information, please contact your local Sales Representative at [www.onsemi.com/support/sales](http://www.onsemi.com/support/sales)