

WCSP-Packaged bq24160/161/163/168 Evaluation Modules

The bq24160/161/163/168 evaluation module is a complete charger module for evaluating compact, flexible, high-efficiency, USB-friendly, switch-mode charge management solution for single-cell, Li-ion and Li-polymer batteries used in a wide range of portable applications.

Contents

1	Introduction	2
	1.1 bq2416x IC Features	2
	1.2 bq24160/161/163/168 EVM Features	2
	1.3 Schematic	3
	1.4 I/O Description	4
	1.5 Test Points	4
	1.6 Control and Key Parameters Setting	4
	1.7 Recommended Operating Conditions	5
2	Test Summary	5
	2.1 Definitions	5
	2.2 Recommended Test Equipment	6
	2.3 Recommended Test Equipment Setup	7
	2.4 Recommended Test Procedure	9
3	Printed-Circuit Board Layout Guideline	11
4	Bill of Materials and Board Layout	12
	4.1 Bill of Materials	12
	4.2 Board Layout	14

List of Figures

1	bq24160/161/163/168EVM (HPA721) Schematic	3
2	BAT_Load (PR1010) Schematic	6
3	Connections of HPA172 Kit.....	8
4	Original Test Setup for bq24160/161/163/168EVM (HPA721).....	8
5	Main Window of bq2416xSW Evaluation Software.....	9
6	Top Assembly Layer	14
7	Top Layer	14
8	First Internal Layer	15
9	Second Internal Layer	15
10	Bottom Layer.....	16

List of Tables

1	Bill of Materials - HPA721	12
---	----------------------------------	----

1 Introduction

1.1 bq2416x IC Features

The bq24160/161/163/168 integrates a synchronous PWM controller, power MOSFETs, input-current sensing, high-accuracy current and voltage regulation, charge termination and power path management into a small WCSP package. The charge parameters can be programmed through an I²C interface. Key IC features include:

- High-efficiency, fully integrated, NMOS-NMOS, synchronous buck charger with 1.5-MHz frequency
- Integrated power FETs for up to 2.5-A charge rate
- Power path management between battery and system voltages

For details, see the bq24160/161/163/168 data sheet ([SLUSA00](#)).

1.2 bq24160/161/163/168 EVM Features

The bq24160/161/163/168 evaluation module (EVM) is a complete charger module for evaluating compact, flexible, high-efficiency, USB-friendly, switch-mode battery charge and power path management solution for single-cell, Li-ion and Li-polymer battery-powered systems used in a wide range of portable applications. Key EVM features include:

- 153-mm × 153-mm × 1.2-mm footprint for entire solution
- Input power connectors for both USB input and ac adapter
- Programmable battery voltage, charge current, input current, and status via I²C™ interface
- IN operating range of 4.2 V – 10 V (bq24160/161/163) or 4.2 V – 6 V (bq24168)
- USB operating range of 4.2 V – 6 V
- LED indication for status signals
- Test points for key signals available for testing purposes. Easy probe hook-up

1.4 I/O Description

Header/Terminal Block	Description
J1-TS	External thermistor positive terminal
J1-GND	Ground terminal for external thermistor
J2-BAT	Battery positive header
J3-BAT	Battery positive terminal
J3-GND	Battery negative terminal
J4-IN	Adapter positive header
J5-IN	Adapter positive terminal
J5-GND	Adapter negative terminal
J6-GND	Battery negative terminal
J7-GND	Adapter negative terminal
J8-USB	USB positive header
J9-USB	USB positive terminal
J9-GND	USB negative terminal
J10-SYS	System output positive header
J11-GND	USB negative header
J12	USB Miniconnector
J13-SYS	System output positive terminal
J13-GND	System output negative terminal
J14-GND	System output negative header
J15-DRV	DRV reference voltage positive header
J16-DRV	DRV reference voltage positive terminal
J16-GND	DRV reference voltage negative terminal
J17	USB-TO-GPIO box connector

1.5 Test Points

Test Point	Description
TP1	Kelvin to VIN
TP2	STAT
TP3	Kelvin to BAT
TP4	Kelvin to USB
TP5	DRV
TP6	INT
TP7	Kelvin to SYS
TP8	GND
TP9	GND
TP10	SW
TP11	SCL
TP12	SDA
TP13	TS

1.6 Control and Key Parameters Setting

Jumper	Description	Default Factory Setting
JP1	1-2 (TS = INT): Connects a potentiometer to the TS so that the potentiometer can emulate a thermistor. The potentiometer has been preset to approximately 3.4 k Ω so that the TS voltage is 0.5 x V (DRV). 2-3 (TS = EXT): Connects the TS pin to an external thermistor. The resistor divider formed by R1 and R3 has been sized to accommodate a 10-k Ω thermistor. If a different thermistor is used, R1 and R3 must be resized.	1-2 (TS = INT)
JP2	1-2 (FET GATE = SYS): External PFET's gate tied to SYS and therefore disabled. 2-3 (FET GATE = BGATE): External PFET's gate tied to BGATE pin and therefore controlled by IC.	2-3 (FET GATE = BGATE)
JP3	Shorting jumper for USB data lines DM (D-) and DP (D+). When shorted, USB input current limit defaults to 1.5 A. Otherwise, USB100 mode is selected.	SHORTED
JP4	bq24161 and bq24168 only 1-2 (PSEL = LO): Indicates that an ac adapter is connected to the USB input and sets the USB input current limit to 1.5 A. 2-3 (PSEL = HI): Indicates that a USB source is connected to the USB input and sets the input current limit to 500 mA.	2-3 (PSEL = HI)
JP5	1-2 (CD = LO): Charge disable low for normal operation 2-3 (CD = HI): Charge disable high to disable charge and enter Hi-Z mode	1-2 (CD = LO)

1.7 Recommended Operating Conditions

		Min	Typ	Max	Unit
Supply voltage, V_{IN}	Input voltage from ac adapter (bq24160/161/163)	4.2		10	V
Supply voltage, V_{IN}	Input voltage from ac adapter (bq24168)	4.2		6	V
USB voltage, V_{USB}	Input voltage from USB or equivalent supply	4.2		6	V
System voltage, V_{SYS}	Voltage output at SYS terminal (bq24160/161/168; depends on VBAT voltage and status of V_{INDPM})	3.3		VBATR EG+4.17 %	V
System voltage, V_{SYS}	Voltage output at SYS terminal (bq24163; depends on VBAT voltage and status of V_{INDPM})	3.1		VBATR EG+4.17 %	V
Battery voltage, V_{BAT}	Voltage output at VBAT terminal (registers set via I2C communication)	3	4.2	4.44	V
Supply current, $I_{IN(MAX)}$	Maximum input current from ac adapter input (registers set via I2C communication)	1.5		2.5	A
Supply current, $I_{USB(MAX)}$	Maximum input current from USB input (registers set via I2C communication)	0.1	0.5	1.5	A
Fast charge current, $I_{CHRG(MAX)}$	Battery charge current (registers set via I2C communication)	0.550		2.5	A
Operating junction temperature range, T_J		-40		125	$^{\circ}$ C

2 Test Summary

This procedure describes one test configuration of the HPA721 evaluation board for bench evaluation.

2.1 Definitions

The following naming conventions are followed.

VXXX :	External voltage supply name (VADP, VBT, VSBT)
LOADW:	External load name (LOADR, LOADI)
V(TPyyy):	Voltage at internal test point TPyyy. For example, V(TP12) means the voltage at TP12.
V(Jxx):	Voltage at header Jxx
V(TP(XXX)):	Voltage at test point XXX. For example, V(ACDET) means the voltage at the test point which is marked as ACDET.

V(XXX, YYY):	Voltage across point XXX and YYY.
I(JXX(YYY)):	Current going out from the YYY terminal of header XX.
Jxx(BBB):	Terminal or pin BBB of header xx.
JPx ON :	Internal jumper Jxx terminals are shorted.
JPx OFF:	Internal jumper Jxx terminals are open.
JPx (-YY-)	ON: Internal jumper Jxx adjacent terminals marked as YY are shorted.
Measure: → A,B	Check specified parameters A, B. If measured values are not within specified limits, the unit under test has failed.
Observe → A,B	Observe if A, B occur. If they do not occur, the unit under test has failed.

Assembly drawings have location for jumpers, test points, and individual components.

2.2 Recommended Test Equipment

2.2.1 Power Supplies

1. Power Supply #1 (PS #1) capable of supplying 6 V at 3 A is required.
2. If not using a battery as the load, then power supply #2 (PS #2) capable of supplying up to 5 V at 5 A is required to power the circuit shown in [Figure 2](#).

2.2.2 Load #1 Between BAT and GND

Testing with an actual battery is the best way to verify operation in the system. If a battery is not available, then a battery or circuit similar to the one shown in [Figure 2](#) can simulate a battery when connected to a power supply.

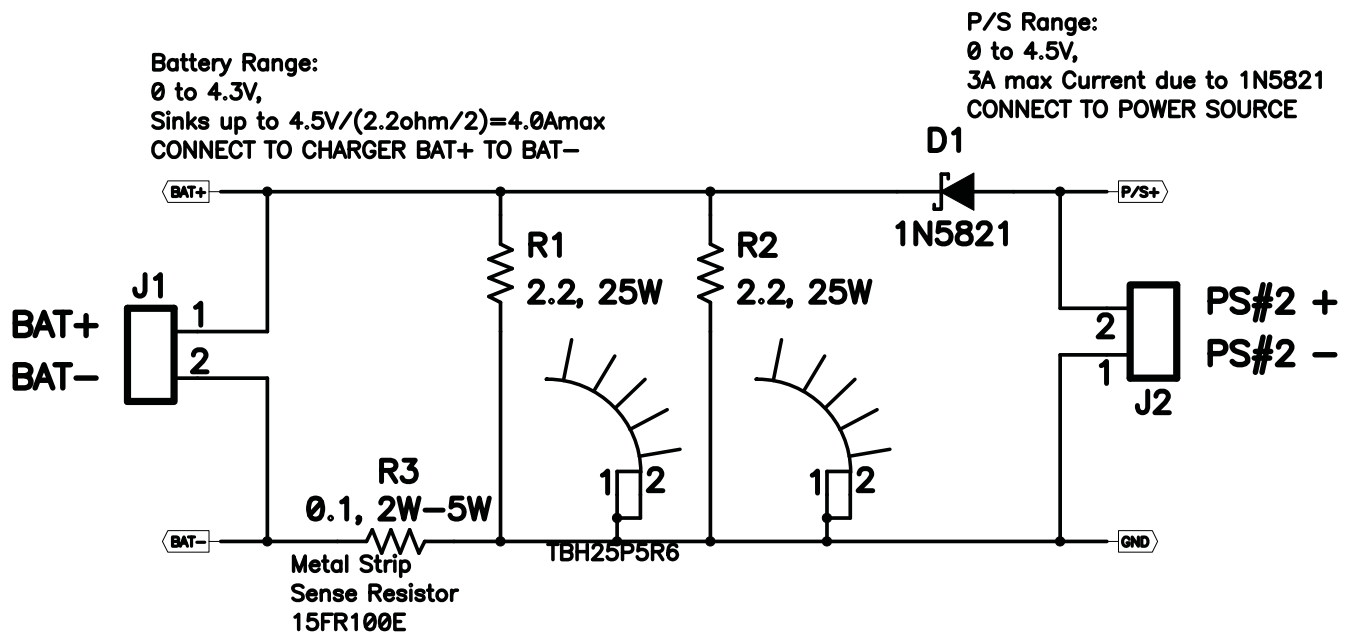

Figure 2. BAT_Load (PR1010) Schematic

2.2.3 Load #2 Between SYS and GND

Although not required, a resistive load capable of sinking up to 3 A can be used.

2.2.4 Meters

Four equivalent voltage meters (VM #) and two equivalent current meters (CM #) are required. The current meters must be able to measure 3-A current.

2.2.5 Computer

A computer with at least one USB port and a USB cable is required. The bq2416x evaluation software must be properly installed.

2.2.6 HPA172 Communication Kit (USB TO GPIO)

A HPA172 USB-to-I²C communication kit is required.

2.2.7 Software

Download BQ2416xSW.zip from the charger's product folder, unzip the file, and double-click on the SETUP.EXE file. Follow the installation steps.

Because the bq24160, bq24161, and bq24163 have the watchdog timers enabled, it is recommended that you set the software's **Reset Watchdog Timer** to reset every 5 seconds. Otherwise, after 30 seconds of operation, the IC enters Default mode. Note that the 27-minute safety timer is not reset by this function and eventually times out if charging does not complete, unless the **Safety Timer Time Limit** is expanded or disabled via the GUI. One way to reset the safety timer is to allow the 30-second watchdog timer to expire. See Figure 3 in the data sheet for more information about the timers.

Also, it is generally helpful to activate the **Write On Change** functions, in the upper left of the GUI window, to ON. The Write On Change function writes any changes to the GUI's check boxes, drop-down boxes, and registers to the IC. Otherwise, the user must click the **WRITE** button to write changes to the software. It is recommended that the user periodically click the **READ** button to find the IC's instantaneous status. Alternatively, the **AutoRead** function can be activated to periodically update the GUI with the IC's status.

2.3 Recommended Test Equipment Setup

1. For all power connections, use short, twisted-pair wires of appropriate gauge wire for the amount of the current.
2. Set Power Supply #1 (PS #1) for 6-V, 3-A current limit and then turn off supply.
3. If BAT_Load as shown in [Figure 1](#) is used, connect Power Supply #2 (PS #2) set to approximately 3.6 V to the input side (PS #2+/-) of BAT_Load, then turn off PS #2.
4. Connect the output side of the battery or BAT_Load in series with current meter (multimeter) #2 (CM #2) to J2 and J6 or J3 (BAT, GND). Ensure that a voltage meter is connected across J2 or TP3 and J6 or TP9 (BAT, GND).
5. Connect VM #3 across J10 or TP7 and J14 or TP9 (SYS, GND).
6. Connect VM #4 across J15 or TP5 and J14 or TP9 (DRV, GND).
7. Connect J17 to HPA172 kit by the 10-pin ribbon cable. Connect the USB port of the HPA172 kit to the USB port of the computer. The connections are shown in [Figure 3](#).

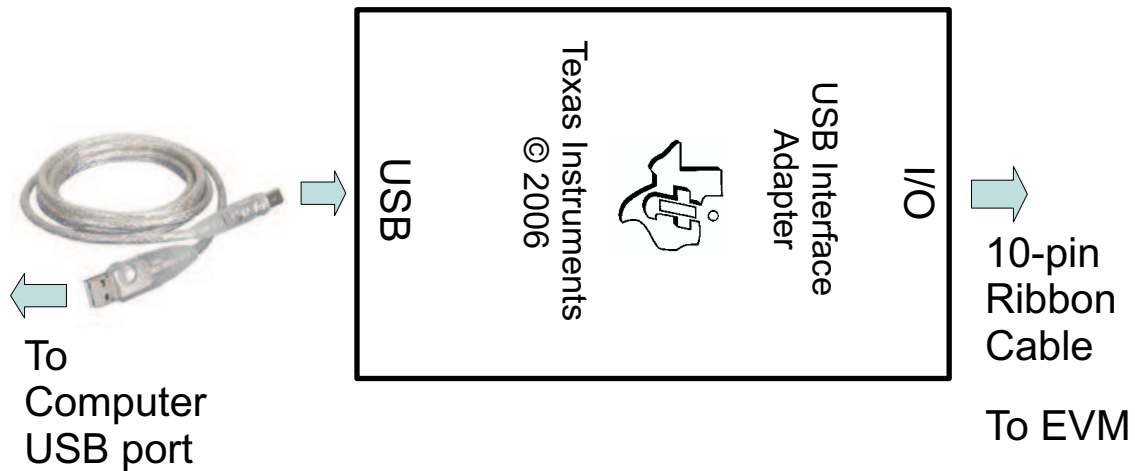

Figure 3. Connections of HPA172 Kit

8. Ensure jumpers are at the default factory settings per [Section 1.6](#)
9. After the preceding steps have been performed, the test setup for HPA721 is configured as is shown in [Figure 4](#)

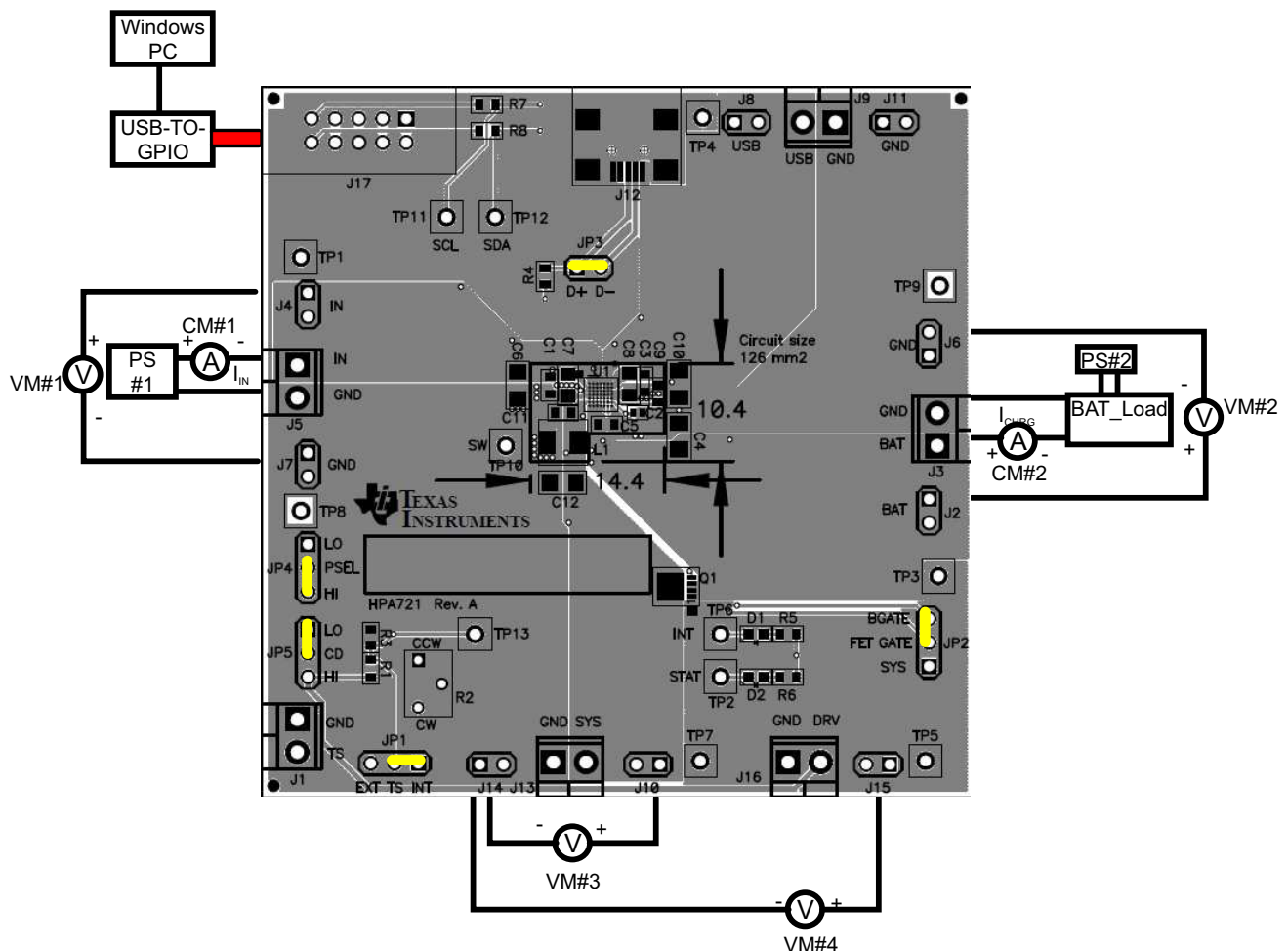

Figure 4. Original Test Setup for bq24160/161/163/168EVM (HPA721)

- Turn on the computer. Open the bq2416x evaluation software. The main window of the software is shown in [Figure 5](#)

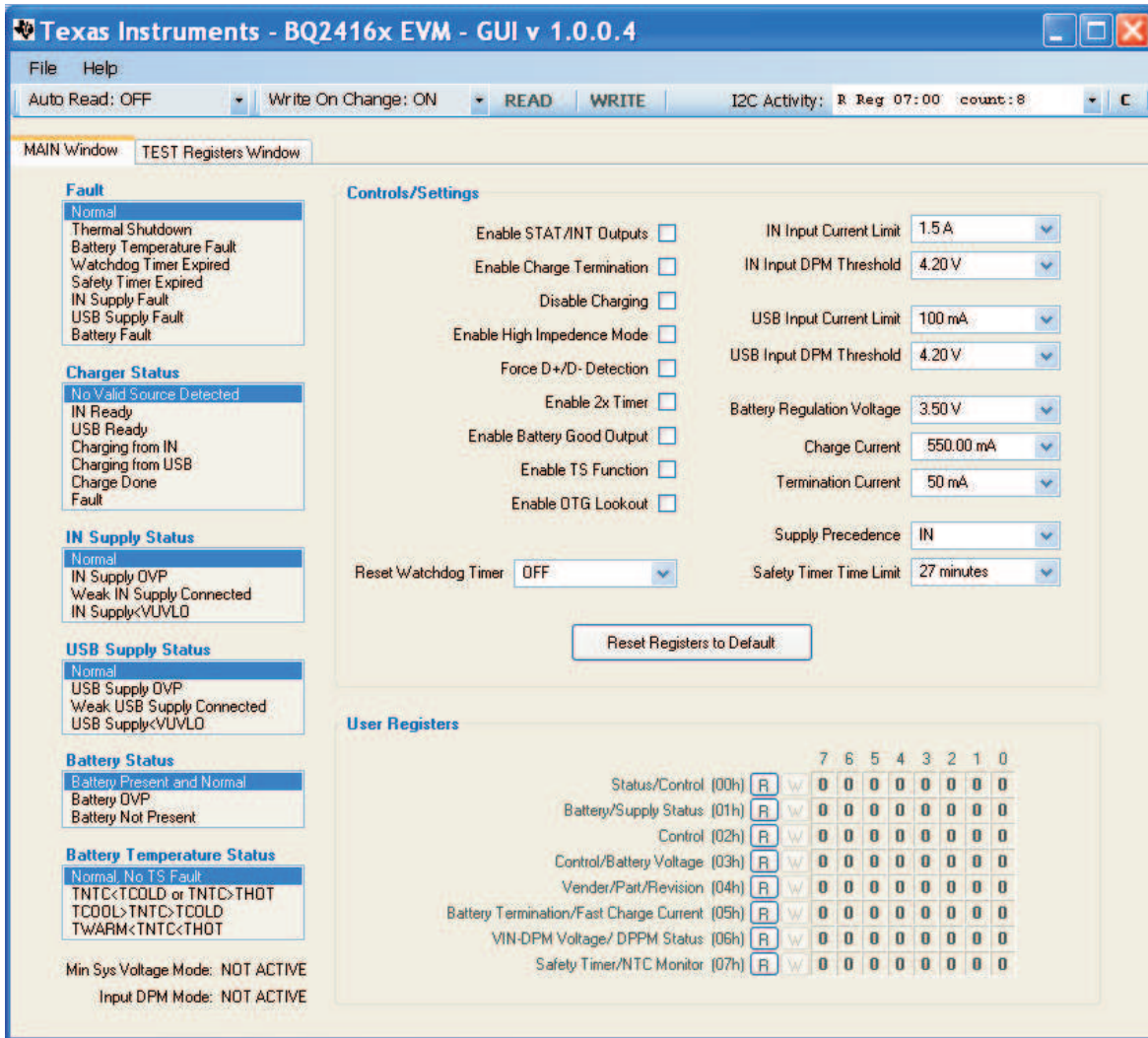

Figure 5. Main Window of bq2416xSW Evaluation Software

2.4 Recommended Test Procedure

The following test procedure may be useful for evaluating the charger IC outside of a real system, if no battery is available to connect to the output and a simulated battery if needed.

2.4.1 Charge Voltage and Current Regulation of IN

- Ensure that the [Section 2.3](#) steps are followed.
- Connect the output of Power Supply #1 (PS #1) in series with current meter (multimeter) #1 (CM #1) to J4 and J7 or J5 (IN, GND).
- Connect voltage meter 1 (VM #1) across J4 or TP1 and J7 or TP8 (IN, GND).
- Move JP5 to HI.
- Turn on PS #1 and PS #2 if used.
- Return JP5 to LO.
- Software setup:
 - Press the **READ** button to obtain the current settings.

- Set **Write On Change** to ON if not already set.
 - Set **Reset Watchdog Timer** to update every 5 seconds.
 - Set **Supply Precedence** to IN if not already set.
 - Uncheck **Disable Charging** if checked.
 - Check **Enable STAT/INT Outputs**.
 - Set **Battery Regulation Voltage** to 4.20 V.
 - Set **IN Input Current Limit** to 2.5 A.
 - Set **Charge Current** to 1000 mA.
 - Click the **READ** button at the top of the window and confirm that the previous settings remain.
8. For the bq24160 EVM, enable PS #2 and adjust PS #2 so that the voltage measured by VM #2, across BAT and GND, measures $3.2\text{ V} \pm 50\text{ mV}$. For the bq24161/163/168 EVMs, enable PS #2 and adjust PS #2 so that the voltage measured by VM #2, across BAT and GND, measures $2.5\text{ V} \pm 50\text{ mV}$.
 9. Adjust the power supply so that VM #1 still reads $6\text{ V} \pm 100\text{ mV}$, if necessary, then
 - Measure on CM#2* $\rightarrow I_{\text{CHRG}} = 1000\text{ mA} \pm 100\text{ mA}$
 - Measure on CM#1* $\rightarrow I_{\text{IN}} = 700\text{ mA} \pm 70\text{ mA}$
 10. Turn off PS #1 and PS #2.

2.4.2 Charge Voltage and Current Regulation of USB

1. Ensure that the [Section 2.3](#) steps are followed.
2. Connect the output of Power Supply #1 (PS #1) in series with current meter (multimeter) #1 (CM #1) to J8 and J11 or J9 (USB, GND).
3. Connect a voltage meter 1 (VM #1) across J8 or TP4 and J11 or TP8 (USB, GND).
4. Move JP5 to HI.
5. Turn on PS #1 and PS #2 if used.
6. Return JP5 to LO.
7. Software setup:
 - Press the **READ** button to obtain the current settings.
 - Set **Write On Change** to ON if not already set.
 - Set **Reset Watchdog Timer** to update every 5 seconds.
 - Set **Supply Precedence** to USB if not already set.
 - Uncheck **Disable Charging** if checked.
 - Check **Enable STAT/INT Outputs**.
 - Set **Battery Regulation Voltage** to 4.20 V.
 - Set **USB Input Current Limit** to 1500 mA.
 - Set **Charge Current** to 1000 mA.
 - Click the **READ** button at the top of the window, and confirm that the previous settings remain.
8. For the bq24160 EVM, enable PS #2 and adjust PS #2 so that the voltage measured by VM #2, across BAT and GND, measures $3.2\text{ V} \pm 50\text{ mV}$. For the bq24161/163/168 EVMs, enable PS #2 and adjust PS #2 so that the voltage measured by VM #2, across BAT and GND, measures $2.5\text{ V} \pm 50\text{ mV}$.
9. Adjust the power supply so that VM #1 still reads $6\text{ V} \pm 100\text{ mV}$ if necessary then
 - Measure on CM#2* $\rightarrow I_{\text{CHRG}} = 1000\text{ mA} \pm 100\text{ mA}$
 - Measure on CM#1* $\rightarrow I_{\text{IN}} = 700\text{ mA} \pm 70\text{ mA}$
10. Turn off PS #1 and PS #2.

2.4.3 Helpful hints

1. To observe the taper current as the battery voltage approaches the set regulation voltage, allow the battery to charge or, if using BAT_Load (PR1010), slowly increase the PS #2 voltage powering BAT_Load (PR1010). Use VM #2 across BAT and GND to measure the battery voltage seen by the IC.

2. To observe the V_{INDPM} function, lower the current limit on PS #1.
3. To observe battery supplement mode, apply a resistive load across SYS and GND that is higher than the maximum charge current.

3 Printed-Circuit Board Layout Guideline

1. To obtain optimal performance, the power input capacitors, connected from the PMID input to PGND, must be placed as close as possible to the bq2416x
2. Place 4.7- μF input capacitor as close to PMID pin and PGND pin as possible to make the high-frequency current loop area as small as possible. Place 1- μF input capacitor GNDs as close to the respective PMID capacitor GND and PGND pins as possible to minimize the ground difference between the input and PMID_.
3. The local bypass capacitor from SYS to GND must be connected between the SYS pin and PGND of the IC. The intent is to minimize the current path loop area from the SW pin through the LC filter and back to the PGND pin.
4. Place all decoupling capacitors close to their respective IC pins and as close as to PGND (do not place components such that routing interrupts power stage currents). All small control signals must be routed away from the high-current paths.
5. The PCB must have a ground plane (return) connected directly to the return of all components through vias (two vias per capacitor for power-stage capacitors, one via per capacitor for small-signal components). It is also recommended to put vias inside the PGND pads for the IC, if possible. A star ground design approach is typically used to keep circuit block currents isolated (high-power/low-power small-signal) which reduces noise-coupling and ground-bounce issues. A single ground plane for this design gives good results. With this small layout and a single ground plane, no ground-bounce issue exists, and having the components segregated minimizes coupling between signals.
6. The high-current charge paths into IN, USB, BAT, SYS, and from the SW pins must be sized appropriately for the maximum charge current in order to avoid voltage drops in these traces. The PGND pins must be connected to the ground plane to return current through the internal low-side FET.
7. For high-current applications, the balls for the power paths must be connected to as much copper in the board as possible. This allows better thermal performance because the board conducts heat away from the IC.

4 Bill of Materials and Board Layout

4.1 Bill of Materials

Table 1. Bill of Materials - HPA721

Count				RefDes	Value	Description	Size	Part Number	MFR
-001	-002	-003	-004						
2	2	2	2	C1, C3	1 μ F	Capacitor, Ceramic, 25V, X5R, 10%	603	Std	Std
2	2	2	2	C2, C5	1 μ F	Capacitor, Ceramic, 6.3V, X5R, 10%	402	Std	Std
1	1	1	1	C4, C12	47 μ F	Capacitor, Ceramic, 6.3V, X5R, 10%	1206	Std	Std
0	0	0	0	C6, C10	Open	Capacitor, Ceramic	1206	Std	Std
2	2	2	2	C7, C8	4.7 μ F	Capacitor, Ceramic, 25V, X5R, 10%	805	Std	Std
1	1	1	1	C9	0.01 μ F	Capacitor, Ceramic, 16V, X7R, 10%	603	Std	Std
1	1	1	1	C11	10 μ F	Capacitor, Ceramic, 10V, X5R, 10%	603	Std	Std
2	2	2	2	D1, D2	Green	Diode, LED, Green, 2.1-V, 20-mA, 6-mcd	603	LTST-C190GKT	Liteon
6	6	6	6	J1, J3, J5, J9, J13, J16	ED555/2DS	Terminal Block, 2-pin, 6-A, 3.5mm	0.27 x 0.25	ED555/2DS	OST
1	1	1	1	J12	UX60-MB-5ST	Connector, Recpt, USB-B, Mini, 5-pins, SMT	0.354 X 0.303 Inches	UX60-MB-5ST	Hiroise Electrical Co
1	1	1	1	J17	N2510-6002-RB	Connector, Male Straight 2x5 pin, 100mil spacing, 4 Wall	0.338 x 0.788 inch	N2510-6002-RB	3M
9	9	9	9	J2, J4, J6, J7, J8, J10, J11, J14, J15	PEC02SAAN	Header, Male 2-pin, 100mil spacing	0.100 inch x 2	PEC02SAAN	Sullins
3	3	3	3	JP1, JP2, JP5	PEC03SAAN	Header, Male 3-pin, 100mil spacing,	0.100 inch x 3	PEC03SAAN	Sullins
1	1	1	1	JP3	PEC02SAAN	Header, Male 2-pin, 100mil spacing,	0.100 inch x 2	PEC02SAAN	Sullins
0	1	1	0	JP4	PEC03SAAN	Header, Male 3-pin, 100mil spacing,	0.100 inch x 3	PEC03SAAN	Sullins
1	1	1	1	L1	1.5 μ H	Inductor, SMT, 3.5A, 70 mW	4.1x4.4 mm	SPM4012T-1R5M Alternate: FSD0415-H-1R5M	TD Alternate: Toko
1	1	1	1	Q1	CSD25401Q3	MOSFET, PChan, -20V, 60A, 8.7 m Ω	QFN3.3X3.3mm	CSD25401Q3	TI
1	1	1	1	R1	1870	Resistor, Chip, 1/16W, 1%	603	Std	Std
1	1	1	1	R2	50.0k	Potentiometer, 3/8 Cermet, 12-Turn	0.25x0.17 inch	3266W-1-503LF	Bourns
1	1	1	1	R3	4120	Resistor, Chip, 1/16W, 1%	603	Std	Std
1	0	0	1	R4	0	Resistor, Chip, 1/16W, 1%	603	Std	Std
2	2	2	2	R5, R6	1.50K	Resistor, Chip, 1/16W, 1%	603	Std	Std
2	2	2	2	R7, R8	200	Resistor, Chip, 1/16W, 1%	603	Std	Std
8	8	8	8	TP1, TP2, TP3, TP4, TP5, TP6, TP7, TP10	5000	Test Point, Red, Thru Hole Color Keyed	0.100 x 0.100 inch	5000	Keystone
2	2	2	2	TP8, TP9	5001	Test Point, Black, Thru Hole Color Keyed	0.100 x 0.100 inch	5001	Keystone
3	3	3	3	TP11, TP12, TP13	5002	Test Point, White, Thru Hole Color Keyed	0.100 x 0.100 inch	5002	Keystone
1	0	0	1	U1	BQ24160YFF	IC, 2.5A, Dual-Input, Single Cell Switch-mode Li-Ion BATTERY CHARGER with	QFN3.3X3.3mm	BQ24160YFF	TI

Table 1. Bill of Materials - HPA721 (continued)

Count				RefDes	Value	Description	Size	Part Number	MFR
-001	-002	-003	-004						
0	1	0	0	U1	BQ24161YFF	IC, 2.5A, Dual-Input, Single Cell Switch-mode Li-Ion BATTERY CHARGER with	QFN3.3X3.3mm	BQ24161YFF	TI
0	0	1	0	U1	BQ24168YFF	IC, 2.5A, Dual-Input, Single Cell Switch-mode Li-Ion BATTERY CHARGER with	QFN3.3X3.3mm	BQ24168YFF	TI
0	0	0	1	U1	BQ24163YFF	IC, 2.5A, Dual-Input, Single Cell Switch-mode Li-Ion BATTERY CHARGER with	QFN3.3X3.3mm	BQ24163YFF	TI
4	5	5	4	—		Shunt, 100-mil, Black	0.100	929950-00	3M

4.2 Board Layout

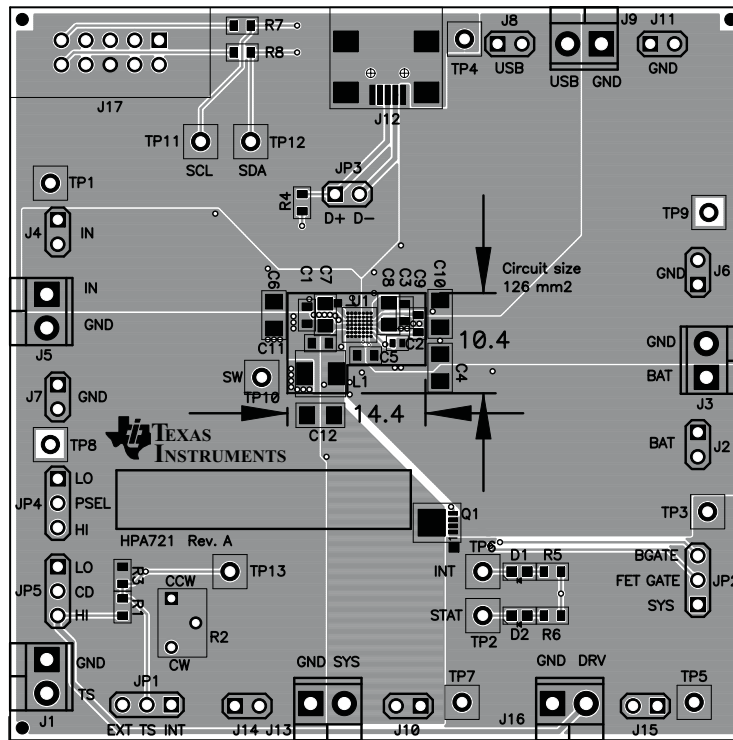

Figure 6. Top Assembly Layer

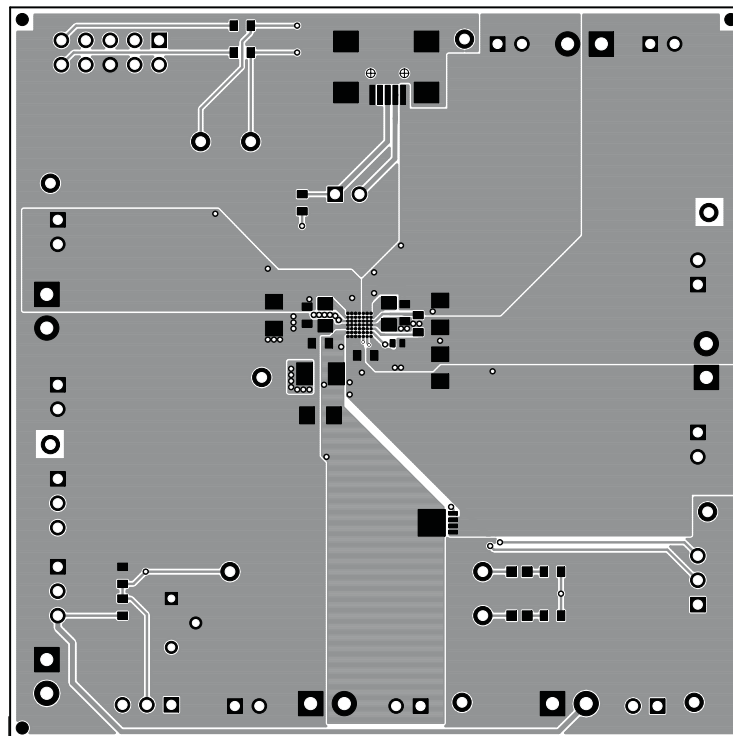

Figure 7. Top Layer

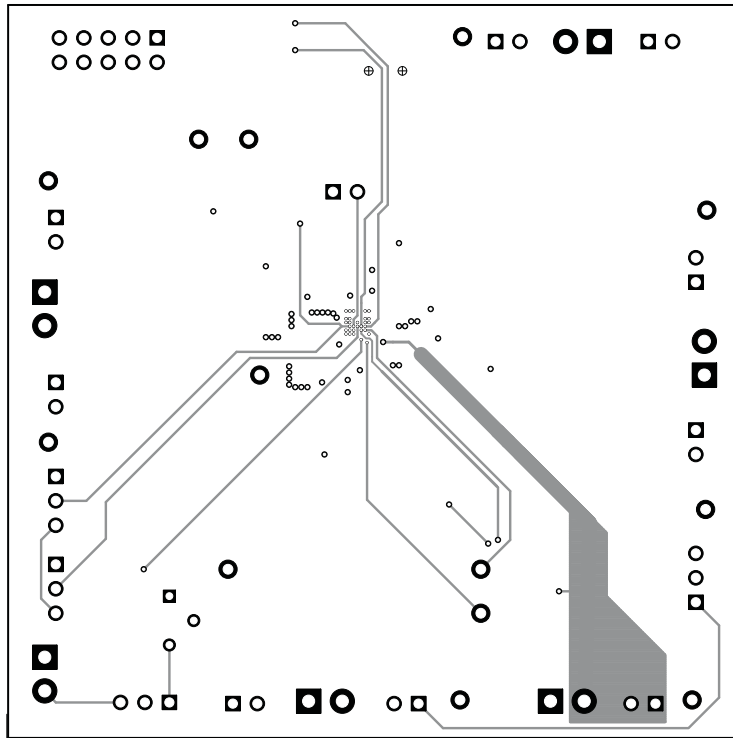

Figure 8. First Internal Layer

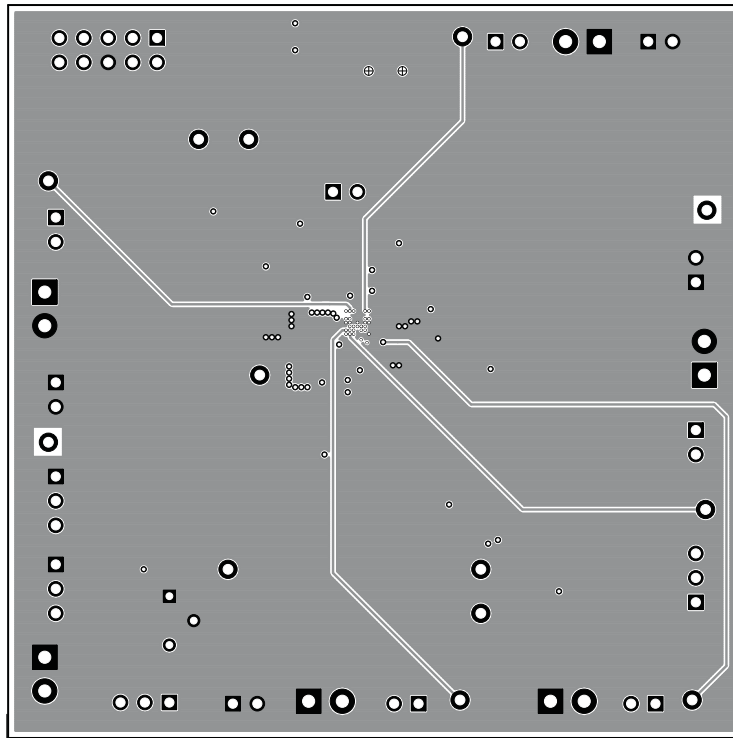

Figure 9. Second Internal Layer

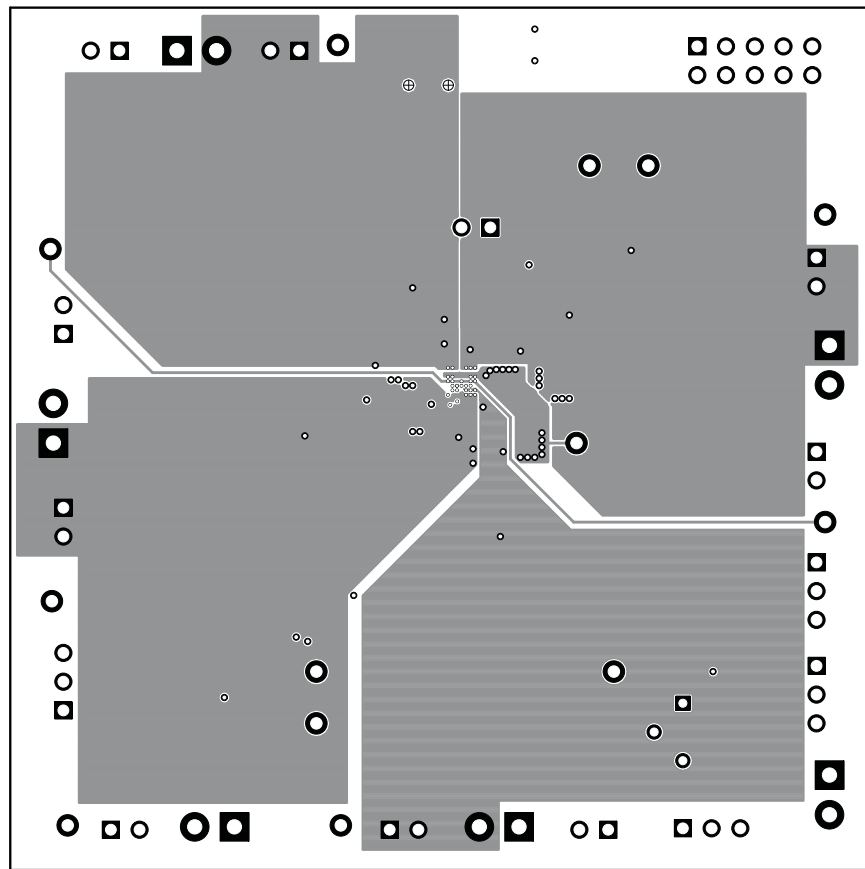

Figure 10. Bottom Layer

EVALUATION BOARD/KIT/MODULE (EVM) ADDITIONAL TERMS

Texas Instruments (TI) provides the enclosed Evaluation Board/Kit/Module (EVM) under the following conditions:

The user assumes all responsibility and liability for proper and safe handling of the goods. Further, the user indemnifies TI from all claims arising from the handling or use of the goods.

Should this evaluation board/kit not meet the specifications indicated in the User's Guide, the board/ kit may be returned within 30 days from the date of delivery for a full refund. THE FOREGOING LIMITED WARRANTY IS THE EXCLUSIVE WARRANTY MADE BY SELLER TO BUYER AND IS IN LIEU OF ALL OTHER WARRANTIES, EXPRESSED, IMPLIED, OR STATUTORY, INCLUDING ANY WARRANTY OF MERCHANTABILITY OR FITNESS FOR ANY PARTICULAR PURPOSE. EXCEPT TO THE EXTENT OF THE INDEMNITY SET FORTH ABOVE, NEITHER PARTY SHALL BE LIABLE TO THE OTHER FOR ANY INDIRECT, SPECIAL, INCIDENTAL, OR CONSEQUENTIAL DAMAGES.

Please read the User's Guide and, specifically, the Warnings and Restrictions notice in the User's Guide prior to handling the product. This notice contains important safety information about temperatures and voltages. For additional information on TI's environmental and/or safety programs, please visit www.ti.com/esh or contact TI.

No license is granted under any patent right or other intellectual property right of TI covering or relating to any machine, process, or combination in which such TI products or services might be or are used. TI currently deals with a variety of customers for products, and therefore our arrangement with the user is not exclusive. TI assumes no liability for applications assistance, customer product design, software performance, or infringement of patents or services described herein.

REGULATORY COMPLIANCE INFORMATION

As noted in the EVM User's Guide and/or EVM itself, this EVM and/or accompanying hardware may or may not be subject to the Federal Communications Commission (FCC) and Industry Canada (IC) rules.

For EVMs **not** subject to the above rules, this evaluation board/kit/module is intended for use for ENGINEERING DEVELOPMENT, DEMONSTRATION OR EVALUATION PURPOSES ONLY and is not considered by TI to be a finished end product fit for general consumer use. It generates, uses, and can radiate radio frequency energy and has not been tested for compliance with the limits of computing devices pursuant to part 15 of FCC or ICES-003 rules, which are designed to provide reasonable protection against radio frequency interference. Operation of the equipment may cause interference with radio communications, in which case the user at his own expense will be required to take whatever measures may be required to correct this interference.

General Statement for EVMs including a radio

User Power/Frequency Use Obligations: This radio is intended for development/professional use only in legally allocated frequency and power limits. Any use of radio frequencies and/or power availability of this EVM and its development application(s) must comply with local laws governing radio spectrum allocation and power limits for this evaluation module. It is the user's sole responsibility to only operate this radio in legally acceptable frequency space and within legally mandated power limitations. Any exceptions to this is strictly prohibited and unauthorized by Texas Instruments unless user has obtained appropriate experimental/development licenses from local regulatory authorities, which is responsibility of user including its acceptable authorization.

For EVMs annotated as FCC – FEDERAL COMMUNICATIONS COMMISSION Part 15 Compliant

Caution

This device complies with part 15 of the FCC Rules. Operation is subject to the following two conditions: (1) This device may not cause harmful interference, and (2) this device must accept any interference received, including interference that may cause undesired operation

Changes or modifications not expressly approved by the party responsible for compliance could void the user's authority to operate the equipment.

FCC Interference Statement for Class A EVM devices

This equipment has been tested and found to comply with the limits for a Class A digital device, pursuant to part 15 of the FCC Rules. These limits are designed to provide reasonable protection against harmful interference when the equipment is operated in a commercial environment. This equipment generates, uses, and can radiate radio frequency energy and, if not installed and used in accordance with the instruction manual, may cause harmful interference to radio communications. Operation of this equipment in a residential area is likely to cause harmful interference in which case the user will be required to correct the interference at his own expense.

REGULATORY COMPLIANCE INFORMATION (continued)

FCC Interference Statement for Class B EVM devices

This equipment has been tested and found to comply with the limits for a Class B digital device, pursuant to part 15 of the FCC Rules. These limits are designed to provide reasonable protection against harmful interference in a residential installation. This equipment generates, uses and can radiate radio frequency energy and, if not installed and used in accordance with the instructions, may cause harmful interference to radio communications. However, there is no guarantee that interference will not occur in a particular installation. If this equipment does cause harmful interference to radio or television reception, which can be determined by turning the equipment off and on, the user is encouraged to try to correct the interference by one or more of the following measures:

- Reorient or relocate the receiving antenna.
- Increase the separation between the equipment and receiver.
- Connect the equipment into an outlet on a circuit different from that to which the receiver is connected.
- Consult the dealer or an experienced radio/TV technician for help.

For EVMs annotated as IC – INDUSTRY CANADA Compliant

This Class A or B digital apparatus complies with Canadian ICES-003.

Changes or modifications not expressly approved by the party responsible for compliance could void the user's authority to operate the equipment.

Concerning EVMs including radio transmitters

This device complies with Industry Canada licence-exempt RSS standard(s). Operation is subject to the following two conditions: (1) this device may not cause interference, and (2) this device must accept any interference, including interference that may cause undesired operation of the device.

Concerning EVMs including detachable antennas

Under Industry Canada regulations, this radio transmitter may only operate using an antenna of a type and maximum (or lesser) gain approved for the transmitter by Industry Canada. To reduce potential radio interference to other users, the antenna type and its gain should be so chosen that the equivalent isotropically radiated power (e.i.r.p.) is not more than that necessary for successful communication.

This radio transmitter has been approved by Industry Canada to operate with the antenna types listed in the user guide with the maximum permissible gain and required antenna impedance for each antenna type indicated. Antenna types not included in this list, having a gain greater than the maximum gain indicated for that type, are strictly prohibited for use with this device.

Cet appareil numérique de la classe A ou B est conforme à la norme NMB-003 du Canada.

Les changements ou les modifications pas expressément approuvés par la partie responsable de la conformité ont pu vider l'autorité de l'utilisateur pour actionner l'équipement.

Concernant les EVMs avec appareils radio

Le présent appareil est conforme aux CNR d'Industrie Canada applicables aux appareils radio exempts de licence. L'exploitation est autorisée aux deux conditions suivantes : (1) l'appareil ne doit pas produire de brouillage, et (2) l'utilisateur de l'appareil doit accepter tout brouillage radioélectrique subi, même si le brouillage est susceptible d'en compromettre le fonctionnement.

Concernant les EVMs avec antennes détachables

Conformément à la réglementation d'Industrie Canada, le présent émetteur radio peut fonctionner avec une antenne d'un type et d'un gain maximal (ou inférieur) approuvé pour l'émetteur par Industrie Canada. Dans le but de réduire les risques de brouillage radioélectrique à l'intention des autres utilisateurs, il faut choisir le type d'antenne et son gain de sorte que la puissance isotrope rayonnée équivalente (p.i.r.e.) ne dépasse pas l'intensité nécessaire à l'établissement d'une communication satisfaisante.

Le présent émetteur radio a été approuvé par Industrie Canada pour fonctionner avec les types d'antenne énumérés dans le manuel d'usage et ayant un gain admissible maximal et l'impédance requise pour chaque type d'antenne. Les types d'antenne non inclus dans cette liste, ou dont le gain est supérieur au gain maximal indiqué, sont strictement interdits pour l'exploitation de l'émetteur.

【Important Notice for Users of this Product in Japan】

This development kit is NOT certified as Confirming to Technical Regulations of Radio Law of Japan

If you use this product in Japan, you are required by Radio Law of Japan to follow the instructions below with respect to this product:

1. Use this product in a shielded room or any other test facility as defined in the notification #173 issued by Ministry of Internal Affairs and Communications on March 28, 2006, based on Sub-section 1.1 of Article 6 of the Ministry's Rule for Enforcement of Radio Law of Japan,
2. Use this product only after you obtained the license of Test Radio Station as provided in Radio Law of Japan with respect to this product, or
3. Use of this product only after you obtained the Technical Regulations Conformity Certification as provided in Radio Law of Japan with respect to this product. Also, please do not transfer this product, unless you give the same notice above to the transferee. Please note that if you could not follow the instructions above, you will be subject to penalties of Radio Law of Japan.

Texas Instruments Japan Limited
(address) 24-1, Nishi-Shinjuku 6 chome, Shinjuku-ku, Tokyo, Japan

<http://www.tij.co.jp>

【ご使用にあたっての注】

本開発キットは技術基準適合証明を受けておりません。

本製品のご使用に際しては、電波法遵守のため、以下のいずれかの措置を取っていただく必要がありますのでご注意ください。

1. 電波法施行規則第6条第1項第1号に基づく平成18年3月28日総務省告示第173号で定められた電波暗室等の試験設備でご使用いただく。
2. 実験局の免許を取得後ご使用いただく。
3. 技術基準適合証明を取得後ご使用いただく。

なお、本製品は、上記の「ご使用にあたっての注意」を譲渡先、移転先に通知しない限り、譲渡、移転できないものとします。

上記を遵守頂けない場合は、電波法の罰則が適用される可能性があることをご留意ください。

日本テキサス・インスツルメンツ株式会社
東京都新宿区西新宿 6 丁目 2 4 番 1 号
西新宿三井ビル

<http://www.tij.co.jp>

EVALUATION BOARD/KIT/MODULE (EVM) WARNINGS, RESTRICTIONS AND DISCLAIMERS

For Feasibility Evaluation Only, in Laboratory/Development Environments. Unless otherwise indicated, this EVM is not a finished electrical equipment and not intended for consumer use. It is intended solely for use for preliminary feasibility evaluation in laboratory/development environments by technically qualified electronics experts who are familiar with the dangers and application risks associated with handling electrical mechanical components, systems and subsystems. It should not be used as all or part of a finished end product.

Your Sole Responsibility and Risk. You acknowledge, represent and agree that:

1. You have unique knowledge concerning Federal, State and local regulatory requirements (including but not limited to Food and Drug Administration regulations, if applicable) which relate to your products and which relate to your use (and/or that of your employees, affiliates, contractors or designees) of the EVM for evaluation, testing and other purposes.
2. You have full and exclusive responsibility to assure the safety and compliance of your products with all such laws and other applicable regulatory requirements, and also to assure the safety of any activities to be conducted by you and/or your employees, affiliates, contractors or designees, using the EVM. Further, you are responsible to assure that any interfaces (electronic and/or mechanical) between the EVM and any human body are designed with suitable isolation and means to safely limit accessible leakage currents to minimize the risk of electrical shock hazard.
3. You will employ reasonable safeguards to ensure that your use of the EVM will not result in any property damage, injury or death, even if the EVM should fail to perform as described or expected.
4. You will take care of proper disposal and recycling of the EVM's electronic components and packing materials.

Certain Instructions. It is important to operate this EVM within TI's recommended specifications and environmental considerations per the user guidelines. Exceeding the specified EVM ratings (including but not limited to input and output voltage, current, power, and environmental ranges) may cause property damage, personal injury or death. If there are questions concerning these ratings please contact a TI field representative prior to connecting interface electronics including input power and intended loads. Any loads applied outside of the specified output range may result in unintended and/or inaccurate operation and/or possible permanent damage to the EVM and/or interface electronics. Please consult the EVM User's Guide prior to connecting any load to the EVM output. If there is uncertainty as to the load specification, please contact a TI field representative. During normal operation, some circuit components may have case temperatures greater than 60°C as long as the input and output are maintained at a normal ambient operating temperature. These components include but are not limited to linear regulators, switching transistors, pass transistors, and current sense resistors which can be identified using the EVM schematic located in the EVM User's Guide. When placing measurement probes near these devices during normal operation, please be aware that these devices may be very warm to the touch. As with all electronic evaluation tools, only qualified personnel knowledgeable in electronic measurement and diagnostics normally found in development environments should use these EVMs.

Agreement to Defend, Indemnify and Hold Harmless. You agree to defend, indemnify and hold TI, its licensors and their representatives harmless from and against any and all claims, damages, losses, expenses, costs and liabilities (collectively, "Claims") arising out of or in connection with any use of the EVM that is not in accordance with the terms of the agreement. This obligation shall apply whether Claims arise under law of tort or contract or any other legal theory, and even if the EVM fails to perform as described or expected.

Safety-Critical or Life-Critical Applications. If you intend to evaluate the components for possible use in safety critical applications (such as life support) where a failure of the TI product would reasonably be expected to cause severe personal injury or death, such as devices which are classified as FDA Class III or similar classification, then you must specifically notify TI of such intent and enter into a separate Assurance and Indemnity Agreement.

Mailing Address: Texas Instruments, Post Office Box 655303, Dallas, Texas 75265
Copyright © 2012, Texas Instruments Incorporated

IMPORTANT NOTICE

Texas Instruments Incorporated and its subsidiaries (TI) reserve the right to make corrections, modifications, enhancements, improvements, and other changes to its products and services at any time and to discontinue any product or service without notice. Customers should obtain the latest relevant information before placing orders and should verify that such information is current and complete. All products are sold subject to TI's terms and conditions of sale supplied at the time of order acknowledgment.

TI warrants performance of its hardware products to the specifications applicable at the time of sale in accordance with TI's standard warranty. Testing and other quality control techniques are used to the extent TI deems necessary to support this warranty. Except where mandated by government requirements, testing of all parameters of each product is not necessarily performed.

TI assumes no liability for applications assistance or customer product design. Customers are responsible for their products and applications using TI components. To minimize the risks associated with customer products and applications, customers should provide adequate design and operating safeguards.

TI does not warrant or represent that any license, either express or implied, is granted under any TI patent right, copyright, mask work right, or other TI intellectual property right relating to any combination, machine, or process in which TI products or services are used. Information published by TI regarding third-party products or services does not constitute a license from TI to use such products or services or a warranty or endorsement thereof. Use of such information may require a license from a third party under the patents or other intellectual property of the third party, or a license from TI under the patents or other intellectual property of TI.

Reproduction of TI information in TI data books or data sheets is permissible only if reproduction is without alteration and is accompanied by all associated warranties, conditions, limitations, and notices. Reproduction of this information with alteration is an unfair and deceptive business practice. TI is not responsible or liable for such altered documentation. Information of third parties may be subject to additional restrictions.

Resale of TI products or services with statements different from or beyond the parameters stated by TI for that product or service voids all express and any implied warranties for the associated TI product or service and is an unfair and deceptive business practice. TI is not responsible or liable for any such statements.

TI products are not authorized for use in safety-critical applications (such as life support) where a failure of the TI product would reasonably be expected to cause severe personal injury or death, unless officers of the parties have executed an agreement specifically governing such use. Buyers represent that they have all necessary expertise in the safety and regulatory ramifications of their applications, and acknowledge and agree that they are solely responsible for all legal, regulatory and safety-related requirements concerning their products and any use of TI products in such safety-critical applications, notwithstanding any applications-related information or support that may be provided by TI. Further, Buyers must fully indemnify TI and its representatives against any damages arising out of the use of TI products in such safety-critical applications.

TI products are neither designed nor intended for use in military/aerospace applications or environments unless the TI products are specifically designated by TI as military-grade or "enhanced plastic." Only products designated by TI as military-grade meet military specifications. Buyers acknowledge and agree that any such use of TI products which TI has not designated as military-grade is solely at the Buyer's risk, and that they are solely responsible for compliance with all legal and regulatory requirements in connection with such use.

TI products are neither designed nor intended for use in automotive applications or environments unless the specific TI products are designated by TI as compliant with ISO/TS 16949 requirements. Buyers acknowledge and agree that, if they use any non-designated products in automotive applications, TI will not be responsible for any failure to meet such requirements.

Following are URLs where you can obtain information on other Texas Instruments products and application solutions:

Products

Audio	www.ti.com/audio
Amplifiers	amplifier.ti.com
Data Converters	dataconverter.ti.com
DLP® Products	www.dlp.com
DSP	dsp.ti.com
Clocks and Timers	www.ti.com/clocks
Interface	interface.ti.com
Logic	logic.ti.com
Power Mgmt	power.ti.com
Microcontrollers	microcontroller.ti.com
RFID	www.ti-rfid.com
OMAP Mobile Processors	www.ti.com/omap
Wireless Connectivity	www.ti.com/wirelessconnectivity

Applications

Automotive and Transportation	www.ti.com/automotive
Communications and Telecom	www.ti.com/communications
Computers and Peripherals	www.ti.com/computers
Consumer Electronics	www.ti.com/consumer-apps
Energy and Lighting	www.ti.com/energy
Industrial	www.ti.com/industrial
Medical	www.ti.com/medical
Security	www.ti.com/security
Space, Avionics and Defense	www.ti.com/space-avionics-defense
Video and Imaging	www.ti.com/video

TI E2E Community Home Page

e2e.ti.com

Mailing Address: Texas Instruments, Post Office Box 655303, Dallas, Texas 75265
Copyright © 2012, Texas Instruments Incorporated