

## Double Metallized Polypropylene Film Capacitor Radial Snubber Type

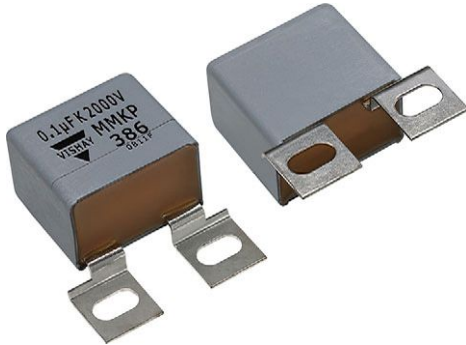

### FEATURES

- Low inductive construction
- Low loss dielectric
- Double sided metallized for high pulse ratings
- Material categorization:  
for definitions of compliance please see  
[www.vishay.com/doc?99912](http://www.vishay.com/doc?99912)

**RoHS**  
COMPLIANT

### APPLICATIONS

Industrial motor control circuits, mounted directly on the IGBT or GTO.

QUICK REFERENCE DATA	
Capacitance range (E12 series)	0.1 $\mu$ F to 4.7 $\mu$ F
Capacitance tolerance	$\pm 5\%$ ; $\pm 10\%$
Rated (DC) voltage	630 V, 850 V, 1000 V, 1250 V, 1400 V, 1600 V, 2000 V, 2500 V
Climatic testing class acc. to IEC 60068-1	55/085/56
Rated (DC) temperature	85 °C
Rated (AC) temperature	85 °C
Maximum application temperature	85 °C
Rated (AC) voltage	220 V, 300 V, 350 V, 425 V, 500 V, 550 V, 700 V, 900 V
Rated peak-to-peak voltage	630 V, 850 V, 1000 V, 1250 V, 1400 V, 1600 V, 2000 V, 2500 V
Reference standards	IEC 60384-17
Dielectric	Polypropylene film
Electrodes	Double metallized
Construction	Mono construction for 630 V version Internal serial construction from 850 V <sub>DC</sub> on
Encapsulation	Flame retardant plastic case (UL-class 94 V-0) and epoxy resin
Tabs	Tinned coated copper
Performance grade	Grade 1 (long life)
Stability grade	Grade 2
Marking	C-value, tolerance; rated voltage; code for dielectric material; code for factory of origin; manufacturer's type; manufacturer; year and week of manufacture

#### Note

- For more detailed data and test requirements contact [dc-film@vishay.com](mailto:dc-film@vishay.com)

**DIMENSIONS** in millimeters

**HORIZONTALLY MOUNTED**

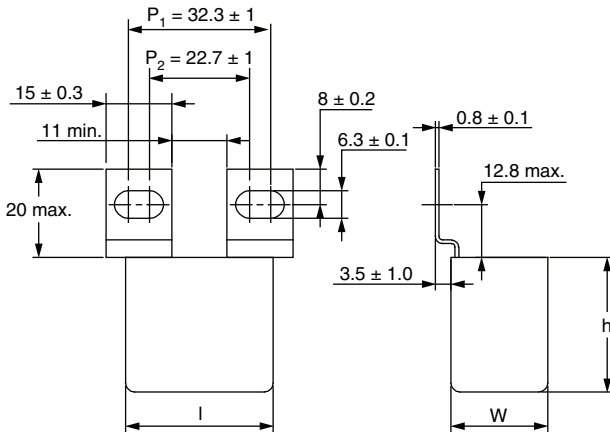

Drawing A

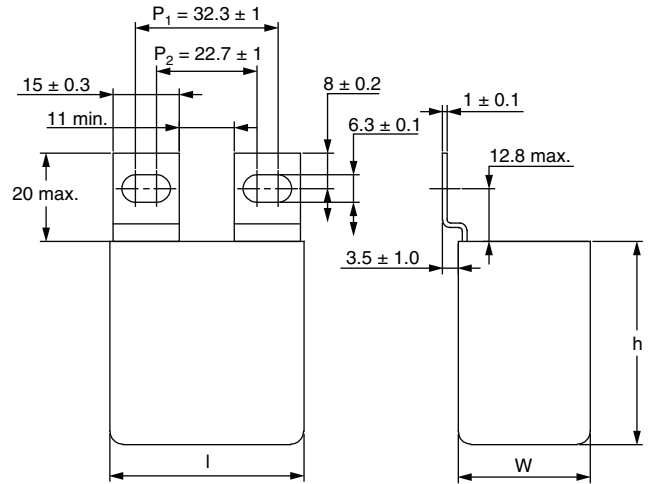

Drawing B

**VERTICALLY MOUNTED**

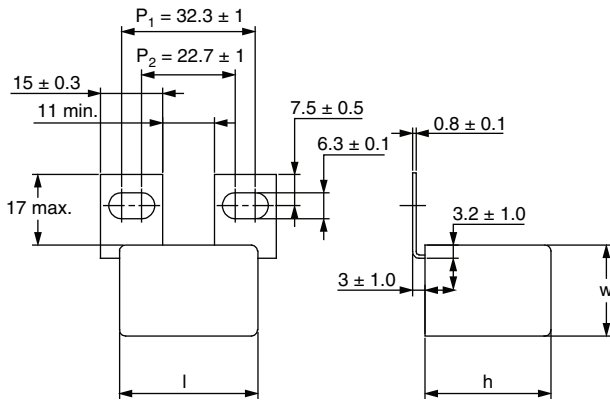

Drawing A

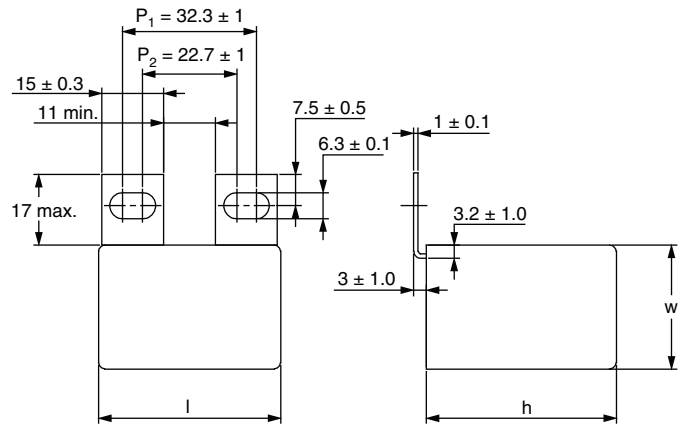

Drawing B

**Note**

P<sub>1</sub> = Pitch 1  
P<sub>2</sub> = Pitch 2



**COMPOSITION OF CATALOG NUMBER**

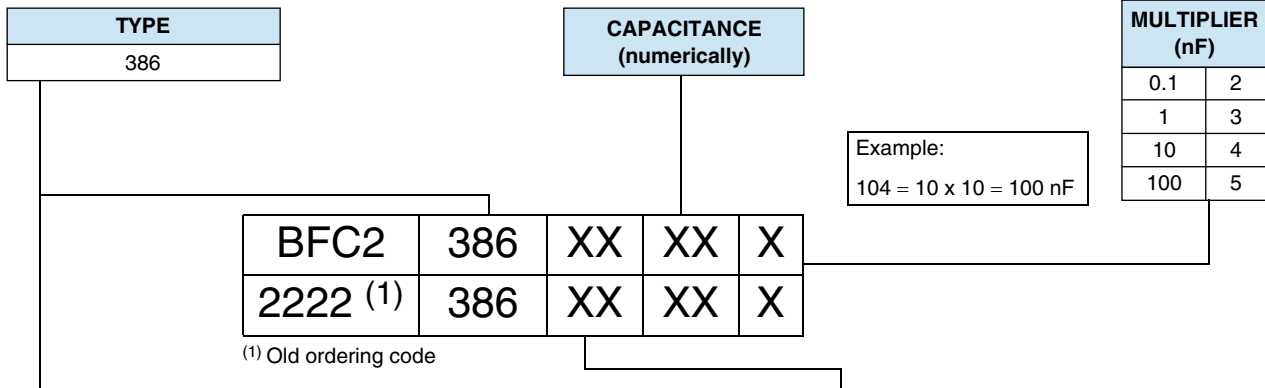

TYPE	PACKAGING	MOUNTING CONFIGURATION	PREFERRED TYPES								
			C-TOL.	630 V	850 V	1000 V	1250 V	1400 V	1600 V	2000 V	2500 V
386	Loose in box	Horizontally mounted	± 10 %	20	00	30	80	40	50	60	70
		Vertically mounted	± 10 %	22	02	32	82	42	52	62	72
			ON REQUEST								
386	Loose in box	Horizontally mounted	± 5 %	21	01	31	81	41	51	61	71
		Vertically mounted	± 5 %	23	03	33	83	43	53	63	73

SPECIFIC REFERENCE DATA								
DESCRIPTION	VALUE							
	630 V	850 V	1000 V	1250 V	1400 V	1600 V	2000 V	2500 V
Capacitance range	0.33 µF to 4.7 µF	0.22 µF to 2.7 µF	0.33 µF to 1.8 µF	0.15 µF to 0.82 µF	0.1 µF to 0.68 µF	0.1 µF to 0.56 µF	0.1 µF to 0.47 µF	0.1 µF to 0.27 µF
Maximum operating DC voltage	630 V	850 V	1000 V	1250 V	1400 V	1600 V	2000 V	2500 V
Maximum operating AC voltage	220 V	300 V	350 V	425 V	500 V	550 V	700 V	900 V
Tangent of loss angle	≤ 0.47 µF		0.56 µF ≤ C ≤ 1.0 µF			C > 1.0 F		
at 1 kHz	< 5 x 10 <sup>-4</sup>		< 5 x 10 <sup>-4</sup>			< 10 x 10 <sup>-4</sup>		
at 10 kHz	< 10 x 10 <sup>-4</sup>		< 10 x 10 <sup>-4</sup>			< 20 x 10 <sup>-4</sup>		
at 100 kHz	< 12 x 10 <sup>-4</sup>		< 25 x 10 <sup>-4</sup>					
R between terminals at 500 V; 1 min	> 5000 MΩ							
R between terminals and case; 500 V; 1 min	> 30 000 MΩ							
Withstanding (DC) voltage (cut off current 10 mA); rise time 100 V/s	1000 V; 1 min	1360 V; 1 min	1600 V; 1 min	2000 V; 1 min	2240 V; 1 min	2560 V; 1 min	3200 V; 1 min	4000 V; 1 min
Withstanding (DC) voltage between terminals and case	2840 V; 1 min							
Maximum dU/dt (V/µs)	630 V	850 V	1000 V	1250 V	1400 V	1600 V	2000 V	2500 V
w x h x l = 22.0 x 30.5 x 33.5	250	650	1000	1500	2000	2400	2500	5500
w x h x l = 22.0 x 38.0 x 44.0	100	350	500	750	900	1000	1000	2000
w x h x l = 30.0 x 46.0 x 44.0	75	260	350	550	650	750	750	1500
ESR at 100 kHz	6 mΩ							
ESL	Typical 15 nH							
Temperature range	- 55 °C to + 85 °C							



<b>ELECTRICAL DATA AND ORDERING INFORMATION</b>					
U <sub>RDC</sub> (V)	CAP. (μF)	DIMENSIONS w x h x l (mm)	MASS (g)	CATALOG NUMBER BFC2 386 XXXXX AND PACKAGING	
				TRAY PACKAGING	
				C-TOL. = ± 10 %	SPQ
630	<b>DRAWING A</b>				
	0.33	22.0 x 30.5 x 33.5	39	20334	56
	0.39		38	20394	
	0.47		38	20474	
	0.56		37	20564	
	0.68		37	20684	
	0.82		36	20824	
	1.0		35	20105	
	1.2		35	20125	
	<b>DRAWING B</b>				
	1.5	22.0 x 38.0 x 44.0	60	20155	42
	1.8		58	20185	
	2.2		56	20225	
	2.7		54	20275	
3.3	30.0 x 46.0 x 44.0	86	20335	36	
3.9		83	20395		
4.7		80	20475		
850	<b>DRAWING A</b>				
	0.22	22.0 x 30.5 x 33.5	39	00224	56
	0.27		39	00274	
	0.33		38	00334	
	0.39		38	00394	
	0.47		37	00474	
	0.56		37	00564	
	0.68		36	00684	
	0.82		35	00824	
	<b>DRAWING B</b>				
	1.0	22.0 x 38.0 x 44.0	61	00105	42
	1.2		59	00125	
	1.5		58	00155	
	1.8	30.0 x 46.0 x 44.0	91	00185	36
2.2	88		00225		
2.7	85		00275		
<b>DRAWING A</b>					
0.33	22.0 x 30.5 x 33.5	36	30334	56	
0.39		35	30394		
0.47		34	30474		
<b>DRAWING B</b>					
0.56	22.0 x 38.0 x 44.0	60	30564	42	
0.68		59	30684		
0.82		57	30824		
1.0		55	30105		
1.2	30.0 x 46.0 x 44.0	88	30125	36	
1.5		84	30155		
1.8		80	30185		
1250	<b>DRAWING A</b>				
	0.15	22.0 x 30.5 x 33.5	37	80154	56
	0.18		35	80184	
	0.22		34	80224	
	0.27		33	80274	
	<b>DRAWING B</b>				
	0.33	22.0 x 38.0 x 44.0	59	80334	42
	0.39		58	80394	
	0.47		57	80474	
	0.56	30.0 x 46.0 x 44.0	89	80564	36
	0.68		85	80684	
	0.82		82	80824	
	<b>DRAWING A</b>				



<b>ELECTRICAL DATA AND ORDERING INFORMATION</b>						
U <sub>RDC</sub> (V)	CAP. (μF)	DIMENSIONS w x h x l (mm)	MASS (g)	CATALOG NUMBER BFC2 386 XXXXX AND PACKAGING		
				TRAY PACKAGING		
				C-TOL. = ± 10 %	SPQ	
1400	<b>DRAWING A</b>					
	0.10	22.0 x 30.5 x 33.5	37	40104	56	
	0.12		36	40124		
	0.15		35	40154		
	<b>DRAWING B</b>					
	0.18	22.0 x 38.0 x 44.0	61	40184	42	
	0.22		59	40224		
	0.27		57	40274		
	0.33		56	40334		
	0.39	30.0 x 46.0 x 44.0	89	40394	36	
	0.47		85	40474		
	0.56		82	40564		
	0.68		79	40684		
	1600	<b>DRAWING A</b>				
0.10		22.0 x 30.5 x 33.5	37	50104	56	
0.12			36	50124		
0.15			35	50154		
<b>DRAWING B</b>						
0.18		22.0 x 38.0 x 44.0	61	50184	42	
0.22			59	50224		
0.27			58	50274		
0.33			57	50334		
0.39		30.0 x 46.0 x 44.0	90	50394	36	
0.47			87	50474		
0.56			84	50564		
2000		<b>DRAWING A</b>				
	0.10	22.0 x 30.5 x 33.5	36	60104	56	
	0.12		35	60124		
	<b>DRAWING B</b>					
	0.15	22.0 x 38.0 x 44.0	61	60154	42	
	0.18		59	60184		
	0.22		58	60224		
	0.27		57	60274		
	0.33	30.0 x 46.0 x 44.0	89	60334	36	
	0.39		86	60394		
	0.47		84	60474		
	2500	<b>DRAWING B</b>				
		0.10	22.0 x 38.0 x 44.0	60	70104	42
		0.12		59	70124	
0.15		57		70154		
0.18		55		70184		
0.22		30.0 x 46.0 x 44.0	87	70224	36	
0.27			83	70274		

**Note**

- SPQ = Standard Packaging Quantity

**MOUNTING**

**Normal Use**

The capacitors are designed for direct mounting on IGBT or GTO.

**Specific Method of Mounting to Withstand Vibration and Shock**

In order to withstand vibration and shock tests, it must be ensured that the tabs are screwed tightly on the test board.

**Storage Temperature**

T<sub>stg</sub> = - 25 °C to + 35 °C with RH maximum 75 % without condensation.

**Ratings and Characteristics Reference Conditions**

Unless otherwise specified, all electrical values apply to an ambient temperature of 23 °C ± 1 °C, an atmospheric pressure of 86 kPa to 106 kPa and a relative humidity of 50 % ± 2 %.

For reference testing, a conditioning period shall be applied over 96 h ± 4 h by heating the products in a circulating air oven at the rated temperature and a relative humidity not exceeding 20 %.

**CHARACTERISTICS**

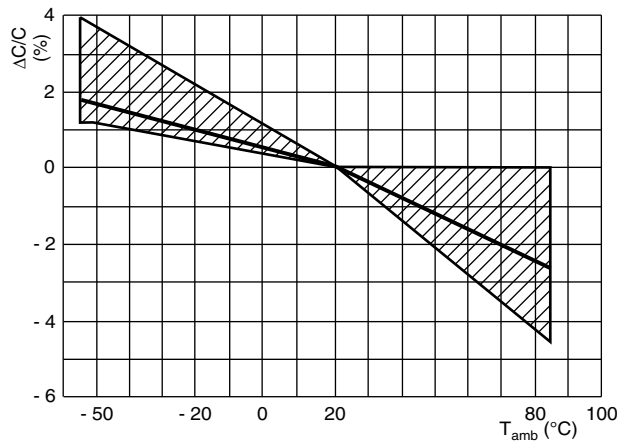

Capacitance as a function of ambient temperature (typical curve)

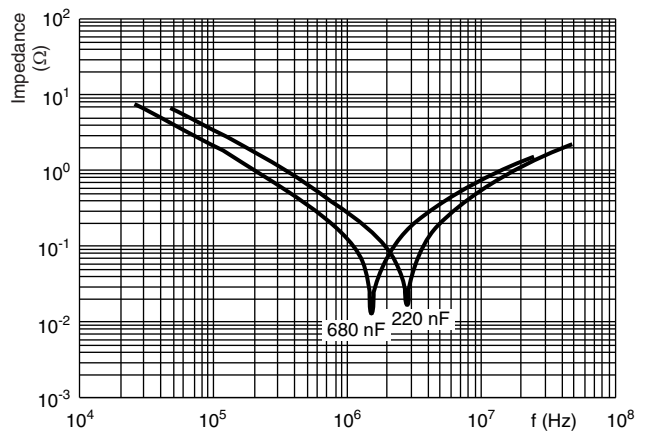

Impedance as a function of frequency (typical curve)

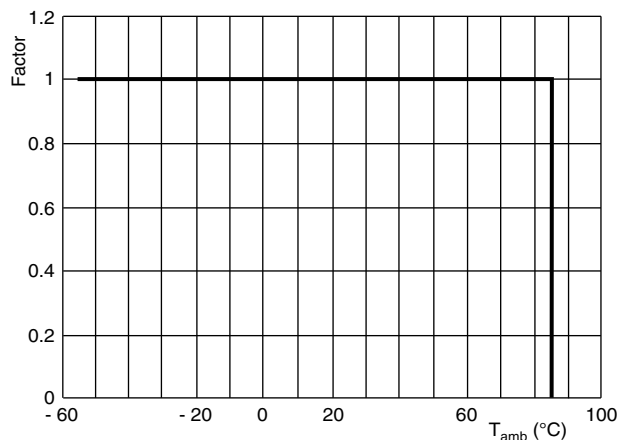

Max. DC and AC voltage as function of temperature

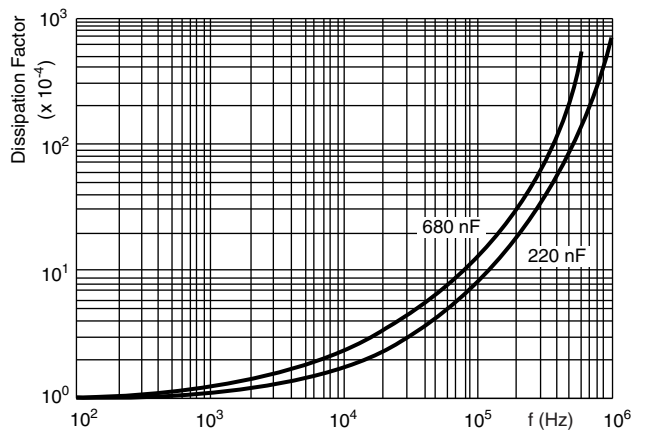

Tangent of loss angle as a function of frequency (typical curve)



CHARACTERISTICS

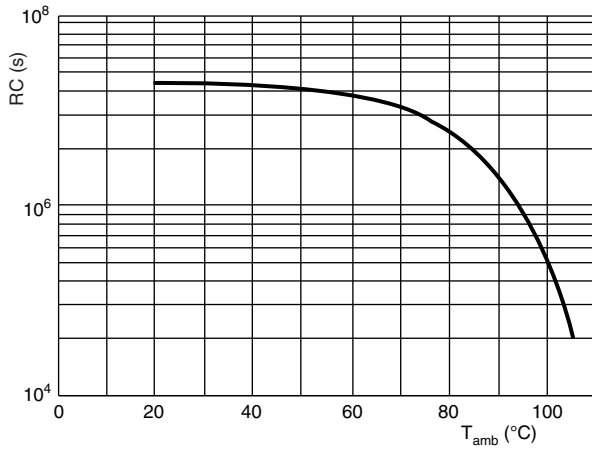

Insulation resistance as a function of ambient temperature (typical curve)

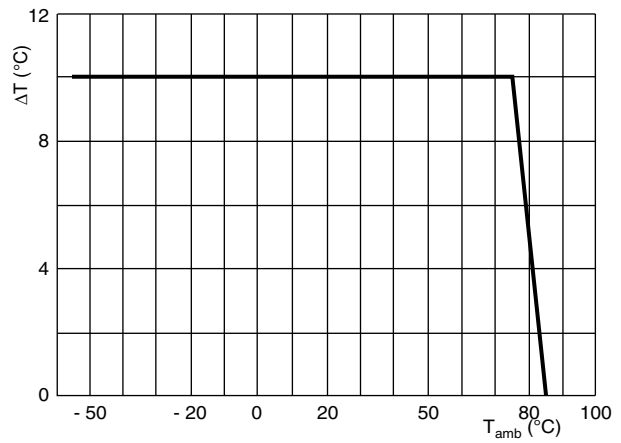

Max. allowed component temperature as a function of ambient temperature

MAXIMUM AC VOLTAGE AS A FUNCTION OF FREQUENCY

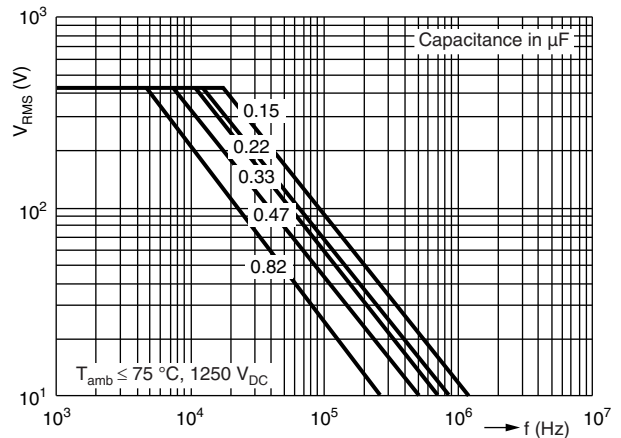
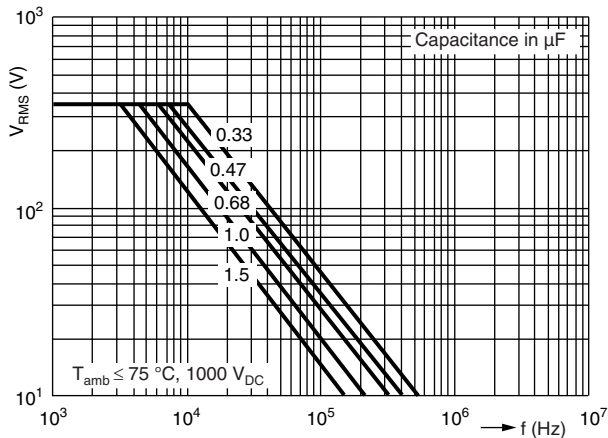
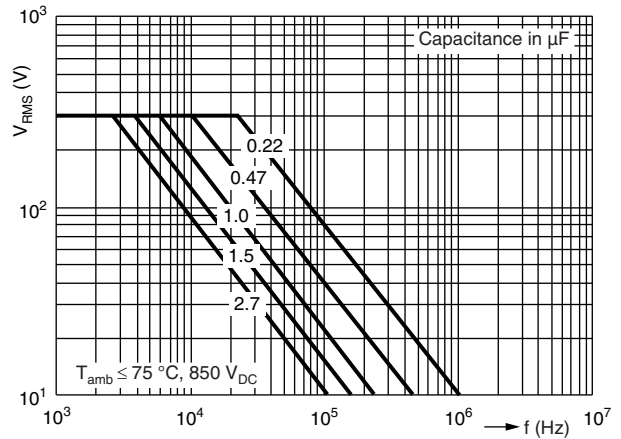
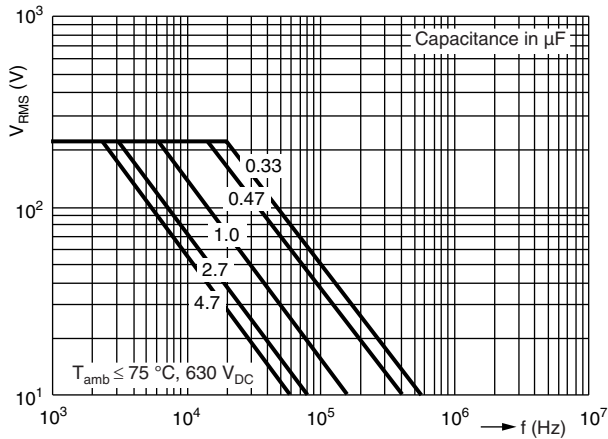

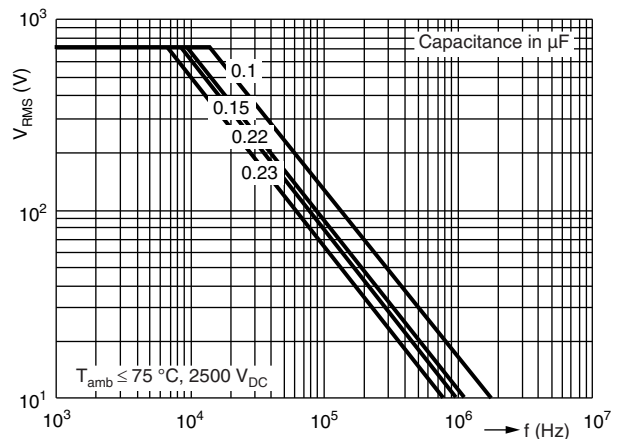
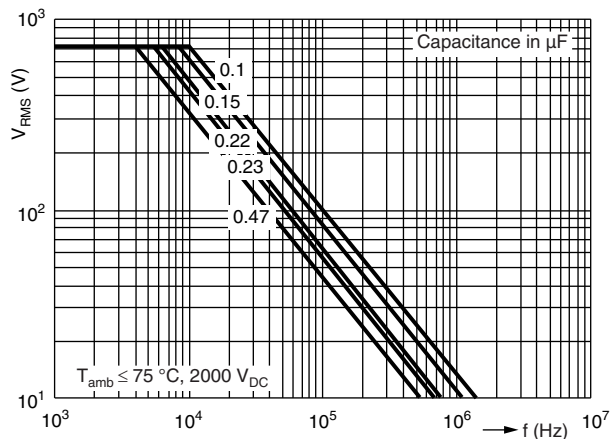
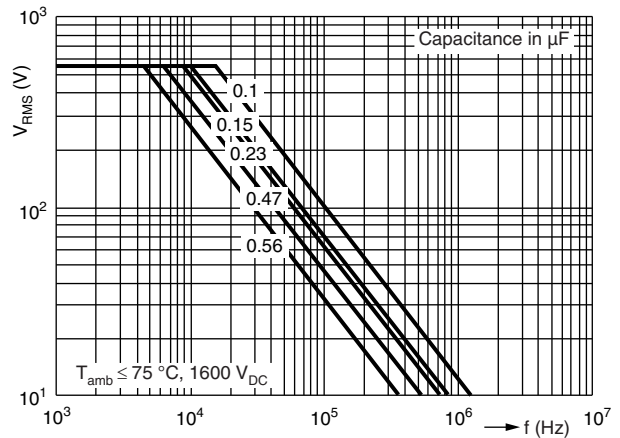
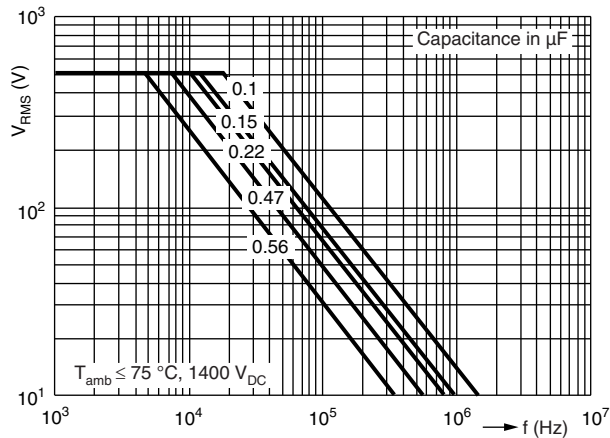
**MAXIMUM AC VOLTAGE AS A FUNCTION OF FREQUENCY**

**HEAT CONDUCTIVITY (G) AS A FUNCTION OF BOX LENGTH AND CAPACITOR BODY THICKNESS IN mW/°C**

W <sub>max.</sub> (mm)	HEAT CONDUCTIVITY (mW/°C)	
	BOX LENGTH 33.5 mm	BOX LENGTH 44.0 mm
22.0	75	100
30.0	-	140

**POWER DISSIPATION AND MAXIMUM COMPONENT TEMPERATURE RISE**

The power dissipation must be limited in order not to exceed the maximum allowed component temperature rise as a function of the free air ambient temperature.

The power dissipation can be calculated according type detail specification “HQN-384-0/101: Technical Information Film Capacitors”.

The component temperature rise ( $\Delta T$ ) can be measured (see section “Measuring the component temperature” for more details) or calculated by  $\Delta T = P/G$ :

- $\Delta T$  = Component temperature rise (°C)
- P = Power dissipation of the component (mW)
- G = Heat conductivity of the component (mW/°C)



### MEASURING THE COMPONENT TEMPERATURE

A thermocouple must be attached to the capacitor body as in:

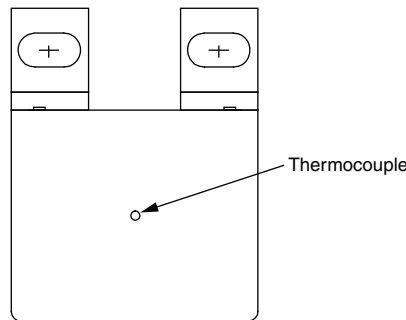

The temperature is measured in unloaded ( $T_{amb}$ ) and maximum loaded condition ( $T_C$ ).

The temperature rise is given by  $\Delta T = T_C - T_{amb}$ .

To avoid radiation or convection, the capacitor should be tested in a wind-free box.

### APPLICATION NOTE AND LIMITING CONDITIONS

These capacitors are not suitable for mains applications as across-the-line capacitors without additional protection, as described hereunder. These mains applications are strictly regulated in safety standards and therefore electromagnetic interference suppression capacitors conforming the standards must be used.

To select the capacitor for a certain application, the following conditions must be checked:

1. The peak voltage ( $U_P$ ) shall not be greater than the rated DC voltage ( $U_{RDC}$ )
2. The peak-to-peak voltage ( $U_{P,p}$ ) shall not be greater than the maximum  $U_{P,p}$  to avoid the ionization inception level
3. The voltage pulse slope ( $dU/dt$ ) shall not exceed the rated voltage pulse slope in an RC-circuit at rated voltage and without ringing. If the pulse voltage is lower than the rated DC voltage, the rated voltage pulse slope may be multiplied by  $U_{RDC}$  and divided by the applied voltage.

For all other pulses following equation must be fulfilled:

$$2 \times \int_0^T \left( \frac{dU}{dt} \right)^2 \times dt < U_{RDC} \times \left( \frac{dU}{dt} \right)_{rated}$$

T is the pulse duration.

The rated voltage pulse slope is valid for ambient temperatures up to 85 °C.

4. The maximum component surface temperature rise must be lower than the limits (see figure).
5. Since in circuits used at voltages over 280 V peak-to-peak the risk for an intrinsically active flammability after a capacitor breakdown (short circuit) increases, it is recommended that the power to the component is limited to 100 times the values mentioned in the table: "Heat Conductivity"

VOLTAGE CONDITIONS	
<b>ALLOWED VOLTAGES</b>	<b><math>T_{amb} \leq 85 \text{ °C}</math></b>
Maximum continuous RMS voltage	$U_{RAC}$
Maximum temperature RMS-overvoltage (< 24 h)	$1.25 \times U_{RAC}$
Maximum peak voltage ( $V_{O,p}$ ) (< 2 s)	$1.6 \times U_{RDC}$



INSPECTION REQUIREMENTS

General Notes

Sub-clause numbers of tests and performance requirements refer to the "Sectional Specification, Publication IEC 60384-17 and Specific Reference Data".

GROUP C INSPECTION REQUIREMENTS		
SUB-CLAUSE NUMBER AND TEST	CONDITIONS	PERFORMANCE REQUIREMENTS
<b>SUB-GROUP C1A PART OF SAMPLE OF SUB-GROUP C1</b>		
4.1 Dimensions (detail)		As specified in chapters "General Data" of this specification
4.3.1 Initial measurements	Capacitance Tangent of loss angle at 100 kHz	
4.14 Component solvent resistance	Isopropylalcohol at room temperature Method: 2 Immersion time: 5 min. ± 0.5 min Recovery time: Min. 1 h, max. 2 h	
4.4.2 Final measurements	Visual examination  Capacitance  Tangent of loss angle	No visible damage Legible marking  $ \Delta C/C  \leq 1\%$ of the value measured initially  Increase of $\tan \delta$ $\leq 0.001$ for: $100\text{ nF} < C \leq 470\text{ nF}$ or $\leq 0.0015$ for: $C > 470\text{ nF}$ Compared to values measured in 4.3.1
<b>SUB-GROUP C1B OTHER PART OF SAMPLE OF SUB-GROUP C1</b>		
4.6.1 Initial measurements	Capacitance Tangent of loss angle at 100 kHz	
4.15 Solvent resistance of the marking	Isopropylalcohol at room temperature Method: 1 Rubbing material: Cotton wool Immersion time: 5.0 min. ± 0.5 min	No visible damage Legible marking
4.6 Rapid change of temperature	$\theta A = -55\text{ }^\circ\text{C}$ $\theta B = +85\text{ }^\circ\text{C}$ 5 cycles Duration $t = 30\text{ min}$	
4.7 Vibration	Visual examination Mounting: See section "Mounting" for more information Procedure B4 Frequency range: 10 Hz to 55 Hz Amplitude: 0.75 mm or Acceleration $98\text{ m/s}^2$ (whichever is less severe) Total duration 6 h	No visible damage
4.7.2 Final inspection	Visual examination	No visible damage
4.9 Shock	Mounting: See section "Mounting" for more information Pulse shape: Half sine Acceleration: $490\text{ m/s}^2$ Duration of pulse: 11 ms	



<b>GROUP C INSPECTION REQUIREMENTS</b>		
<b>SUB-CLAUSE NUMBER AND TEST</b>	<b>CONDITIONS</b>	<b>PERFORMANCE REQUIREMENTS</b>
<b>SUB-GROUP C1B OTHER PART OF SAMPLE OF SUB-GROUP C1</b>		
4.9.3 Final measurements	Visual examination  Capacitance  Tangent of loss angle  Insulation resistance	No visible damage  $ \Delta C/C  \leq 1\%$ of the value measured in 4.6.1  Increase of $\tan \delta$ $\leq 0.001$ for: $100 \text{ nF} < C \leq 470 \text{ nF}$ or $\leq 0.0015$ for: $C > 470 \text{ nF}$ Compared to values measured in 4.6.1  As specified in section "Insulation Resistance" of this specification
<b>SUB-GROUP C1 COMBINED SAMPLE OF SPECIMENS OF SUB-GROUPS C1A AND C1B</b>		
4.10 Climatic sequence		
4.10.2 Dry heat	Temperature: + 85 °C Duration: 16 h	
4.10.3 Damp heat cyclic Test Db, first cycle		
4.10.4 Cold	Temperature: - 55 °C Duration: 2 h	
4.10.6 Damp heat cyclic Test Db, remaining cycles		
4.10.6.2 Final measurements	Voltage proof = $U_{RDC}$ for 1 min within 15 min after removal from testchamber  Visual examination  Capacitance  Tangent of loss angle  Insulation resistance	No breakdown of flashover  No visible damage Legible marking  $ \Delta C/C  \leq 2\%$ of the value measured in 4.4.2 or 4.9.3  Increase of $\tan \delta$ $\leq 0.001$ for: $100 \text{ nF} < C \leq 470 \text{ nF}$ or $\leq 0.0015$ for: $C > 470 \text{ nF}$ Compared to values measured in 4.3.1. or 4.6.1  $\geq 50\%$ of values specified in section "Insulation Resistance" of this specification
<b>SUB-GROUP C2</b>		
4.11 Damp heat steady state	56 days, 40 °C, 90 % to 95 % RH no load	
4.11.1 Initial measurements	Capacitance Tangent of loss angle at 1 kHz	



GROUP C INSPECTION REQUIREMENTS		
SUB-CLAUSE NUMBER AND TEST	CONDITIONS	PERFORMANCE REQUIREMENTS
<b>SUB-GROUP C2</b>		
4.11.3 Final measurements	Voltage proof = $U_{RDC}$ for 1 min within 15 min after removal from testchamber  Visual examination  Capacitance  Tangent of loss angle  Insulation resistance	No breakdown of flashover  No visible damage Legible marking  $ \Delta C/C  \leq 1\%$ of the value measured in 4.11.1.  Increase of $\tan \delta$ $\leq 0.001$ for: $100\text{ nF} < C \leq 470\text{ nF}$ or $\leq 0.0015$ for: $C \leq 470\text{ nF}$ Compared to values measured in 4.11.1  $\geq 50\%$ of values specified in section "Insulation Resistance" of this specification
<b>SUB-GROUP C3A</b>		
4.12.1 Endurance test at 50 Hz alternating voltage	Duration: 2000 h Voltage: $1.25 \times U_{RAC}$ at $85\text{ }^\circ\text{C}$	
4.12.1.1 Initial measurements	Capacitance Tangent of loss angle at 100 kHz	
4.12.1.3 Final measurements	Visual examination  Capacitance  Tangent of loss angle  Insulation resistance	No visible damage Legible marking  $ \Delta C/C  \leq 5\%$ compared to values measured in 4.12.1.1  Increase of $\tan \delta$ $\leq 0.001$ for: $100\text{ nF} < C \leq 470\text{ nF}$ or $\leq 0.0015$ for: $C > 470\text{ nF}$ Compared to values measured in 4.12.1.1  $\geq 50\%$ of values specified in section "Insulation Resistance" of this specification
<b>SUB-GROUP C4</b>		
4.2.6 Temperature characteristics Initial measurements Intermediate measurements Final measurements	Capacitance Capacitance at $-55\text{ }^\circ\text{C}$ Capacitance at $20\text{ }^\circ\text{C}$ Capacitance at $+85\text{ }^\circ\text{C}$ Capacitance  Insulation resistance	For $-55\text{ }^\circ\text{C}$ to $+20\text{ }^\circ\text{C}$ : $+1\% \leq  \Delta C/C  \leq 3.75\%$ or for $20\text{ }^\circ\text{C}$ to $105\text{ }^\circ\text{C}$ : $-6\% \leq  \Delta C/C  \leq 0\%$ As specified in section "Capacitance" of this specification.  As specified in section "Insulation Resistance" of this specification
4.13 Charge and discharge	10 000 cycles Charged to $U_{RDC}$ Discharge resistance:  $R = \frac{U_{RDC}}{5 \times C \times (dU/dt)}$	
4.13.1 Initial measurements	Capacitance Tangent of loss angle at 100 kHz	
4.13.3 Final measurements	Capacitance  Tangent of loss angle  Insulation resistance	$ \Delta C/C  \leq 1\%$ compared to values measured in 4.13.1  Increase of $\tan \delta$ $\leq 0.001$ for: $100\text{ nF} < C \leq 470\text{ nF}$ or $\leq 0.0015$ for: $C > 470\text{ nF}$ Compared to values measured in 4.13.1  $\geq 50\%$ of values specified in section "Insulation Resistance" of this specification



## **Disclaimer**

ALL PRODUCT, PRODUCT SPECIFICATIONS AND DATA ARE SUBJECT TO CHANGE WITHOUT NOTICE TO IMPROVE RELIABILITY, FUNCTION OR DESIGN OR OTHERWISE.

Vishay Intertechnology, Inc., its affiliates, agents, and employees, and all persons acting on its or their behalf (collectively, "Vishay"), disclaim any and all liability for any errors, inaccuracies or incompleteness contained in any datasheet or in any other disclosure relating to any product.

Vishay makes no warranty, representation or guarantee regarding the suitability of the products for any particular purpose or the continuing production of any product. To the maximum extent permitted by applicable law, Vishay disclaims (i) any and all liability arising out of the application or use of any product, (ii) any and all liability, including without limitation special, consequential or incidental damages, and (iii) any and all implied warranties, including warranties of fitness for particular purpose, non-infringement and merchantability.

Statements regarding the suitability of products for certain types of applications are based on Vishay's knowledge of typical requirements that are often placed on Vishay products in generic applications. Such statements are not binding statements about the suitability of products for a particular application. It is the customer's responsibility to validate that a particular product with the properties described in the product specification is suitable for use in a particular application. Parameters provided in datasheets and / or specifications may vary in different applications and performance may vary over time. All operating parameters, including typical parameters, must be validated for each customer application by the customer's technical experts. Product specifications do not expand or otherwise modify Vishay's terms and conditions of purchase, including but not limited to the warranty expressed therein.

Hyperlinks included in this datasheet may direct users to third-party websites. These links are provided as a convenience and for informational purposes only. Inclusion of these hyperlinks does not constitute an endorsement or an approval by Vishay of any of the products, services or opinions of the corporation, organization or individual associated with the third-party website. Vishay disclaims any and all liability and bears no responsibility for the accuracy, legality or content of the third-party website or for that of subsequent links.

Vishay products are not designed for use in life-saving or life-sustaining applications or any application in which the failure of the Vishay product could result in personal injury or death unless specifically qualified in writing by Vishay. Customers using or selling Vishay products not expressly indicated for use in such applications do so at their own risk. Please contact authorized Vishay personnel to obtain written terms and conditions regarding products designed for such applications.

No license, express or implied, by estoppel or otherwise, to any intellectual property rights is granted by this document or by any conduct of Vishay. Product names and markings noted herein may be trademarks of their respective owners.