

AC and Pulse Metallized Polypropylene Film Capacitors MKP Axial Type

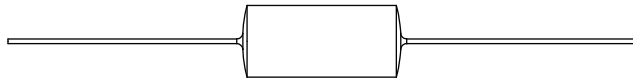

FEATURES

- Supplied loose in box, taped on ammpack or reel available on request
- Material categorization: for definitions of compliance please see www.vishay.com/doc?99912



RoHS
COMPLIANT
HALOGEN
FREE
GREEN
(5-2008)

APPLICATIONS

High current and high pulse operations

QUICK REFERENCE DATA	
Capacitance range (E12 series)	0.1 μ F to 3.3 μ F
Capacitance tolerance	$\pm 5\%$
Rated DC voltage	630 V _{DC} , 850 V _{DC} , 1250 V _{DC} , 1600 V _{DC}
Rated AC voltage	300 V _{AC} , 400 V _{AC} , 425 V _{AC} , 450 V _{AC}
Climatic testing class according to IEC 60068-1	55/110/56
Rated temperature	85 °C
Maximum application temperature	At 85 °C: U _C = 1.0 U _R At 110 °C: U _C = 0.7 U _R
Reference standards	IEC 60384-17
Dielectric	Polypropylene film
Electrodes	Metallized
Construction	Series construction
Encapsulation	Plastic-wrapped, epoxy resin sealed. Flame retardant
Leads	Tinned wire
Pull test on leads	≥ 20 N in direction of leads according to IEC 60068-2-21
Bent test on leads	2 bends through 90° with half of the force used in pull test
Reliability	Operation life > 300 000 h Failure rate < 5 FIT (40 °C and 0.5 x U _R)
Marking	Manufacturer's logo; code for dielectric material; manufacturer's type designation; C-code; rated voltage-code; tolerance-code; special n °C-value; tolerance; rated voltage; year and week; manufacturer's location

Note

- For more detailed data and test requirements, contact dc-film@vishay.com

DIMENSIONS in millimeters



COMPOSITION OF CATALOG NUMBER



Note

(1) For detailed tape specifications refer to packaging information: www.vishay.com/doc?28139 or end of catalog

SPECIFIC REFERENCE DATA				
DESCRIPTION	VALUE			
Tangent of loss angle: 0.1 μF < C ≤ 0.47 μF 0.47 μF < C ≤ 1 μF 1 μF < C ≤ 3.3 μF	1 kHz	10 kHz	100 kHz	
	≤ 3 x 10 ⁻⁴	≤ 5 x 10 ⁻⁴	≤ 40 x 10 ⁻⁴	
	≤ 3 x 10 ⁻⁴	≤ 8 x 10 ⁻⁴	≤ 60 x 10 ⁻⁴	
	≤ 3 x 10 ⁻⁴	≤ 15 x 10 ⁻⁴	-	
Rated voltage pulse slope (dU/dt) _R at U _{RDC}	630 V _{DC}	850 V _{DC}	1250 V _{DC}	1600 V _{DC}
	500 V/μs	1000 V/μs	1000 V/μs	1000 V/μs
U _{p-p} peak-to-peak voltage	700 V	1130 V	1400 V	1600 V
R between leads, for C ≤ 0.33 μF at 500 V, 1 min	> 100 GΩ			
RC between leads, for C > 0.33 μF at 500 V, 1 min	> 30 000 s			
R between interconnecting and wrapped film at 500 V, 1 min	> 100 GΩ			
Withstanding (DC) voltage (cut off current 10 mA), rise time 100 V/s	1008 V	1360 V	2000 V	2560 V
	1 min			
Withstanding (DC) voltage between leads and wrapped film (1.4 x U _{RAC} + 2000)	2840 V, 1 min			
Maximum application temperature	110 °C			



ELECTRICAL DATA AND ORDERING INFORMATION											
U _{RDC} (V)	CAP. (µF)	VOLTAGE CODE	V _{AC}	DIMENSIONS (mm)		d _t ± 0.08 mm (mm)	MASS (g)	SPQ ⁽¹⁾ (pieces)			
				D _{max.}	L _{max.}						
630	0.10	63	300	7	26.5	0.8	0.9	2000			
	0.15			8	26.5		1.2	1750			
	0.18			8.5	26.5		1.4	1500			
	0.22			9.5	26.5		1.6	1250			
	0.27			10	26.5		1.9	1000			
	0.33			11	26.5		2.3	900			
	0.39			10.5	31.5		2.6	900			
	0.47			11	31.5		3.0	750			
	0.56			12	31.5		3.5	650			
	0.68			13	31.5		4.2	500			
	0.82			14	31.5	5.1	1000				
	1.00			16	31.5	6.1	900				
	1.50			19	31.5	9.0	600				
	2.20			23	31.5	13.1	450				
	3.30			28	31.5	19.5	300				
850	0.10	08	400	8.5	31.5	0.8	1.6	1500			
	0.15			10	31.5		2.3	1000			
	0.18			11	31.5		2.7	850			
	0.22			11.5	31.5		3.2	750			
	0.27			13	31.5		3.9	1000			
	0.33			14	31.5		4.6	1000			
	0.39			15	31.5		5.4	1000			
	0.47			16.5	31.5		6.5	1000			
	0.56			15	31.5		5.4	1000			
	0.68			16.5	31.5		6.5	1000			
	0.82			18	31.5	7.8	750				
	1.00			19.5	31.5	9.4	600				
	1.50			24	31.5	13.9	400				
	1250			0.10	12	425	8.5	31.5	0.8	1.6	1500
				0.15			10	31.5		2.3	1000
0.18		11	31.5	2.7			750				
0.22		11.5	31.5	3.2			800				
0.27		13	31.5	3.9			650				
0.33		14	31.5	4.6			500				
0.39		15	31.5	5.4			1000				
0.47		16.5	31.5	6.5			900				
0.56		18	31.5	7.7			750				
0.68		20	31.5	9.2			600				
0.82		21.5	31.5	11.1			500				
1.00		23.5	31.5	13.4			400				
1600		0.10	13	450			12	31.5	0.8	2.7	750
		0.15					14	31.5		3.9	600
		0.18					15	31.5		4.6	500
	0.22	16.5			31.5	5.5	500				
	0.27	17.5			31.5	6.7	650				
	0.33	20			31.5	8.1	600				
	0.39	21.5			31.5	9.5	600				
	0.47	23.5			31.5	11.3	500				
	0.56	25.5			31.5	13.4	400				
	0.68	28			31.5	16.2	350				

Note

⁽¹⁾ SPQ = Standard Packing Quantity

MOUNTING

Normal Use

The capacitors are designed for mounting on printed-circuit boards. The capacitors packed in bandoliers are designed for mounting in printed-circuit boards by means of automatic insertion machines.

Specific Method of Mounting to Withstand Vibration and Shock

In order to withstand vibration and shock tests, it must be ensured that the capacitor body is in good contact with the printed-circuit board.

- For $L \leq 19$ mm capacitors shall be mechanically fixed by the leads
- For larger pitches the capacitors shall be mounted in the same way and the body clamped
- The maximum diameter and length of the capacitors are specified in the dimensions table
- Eccentricity as shown in the drawing below:

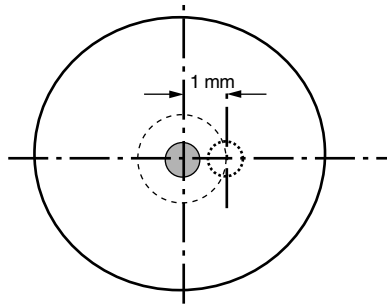

Soldering Conditions

For general soldering conditions and wave soldering profile, we refer to application note: "Soldering Guidelines for Film Capacitors": www.vishay.com/doc?28171

Storage Temperature

$T_{stg} = -25$ °C to $+35$ °C with RH maximum 75 % without condensation

Ratings and Characteristics Reference Conditions

Unless otherwise specified, all electrical values apply to an ambient free air temperature of 23 °C ± 1 °C, an atmospheric pressure of 86 kPa to 106 kPa and a relative humidity of 50 % ± 2 %.

For reference testing, a conditioning period shall be applied over 96 h ± 4 h by heating the products in a circulating air oven at the rated temperature and a relative humidity not exceeding 20 %.

CHARACTERISTICS

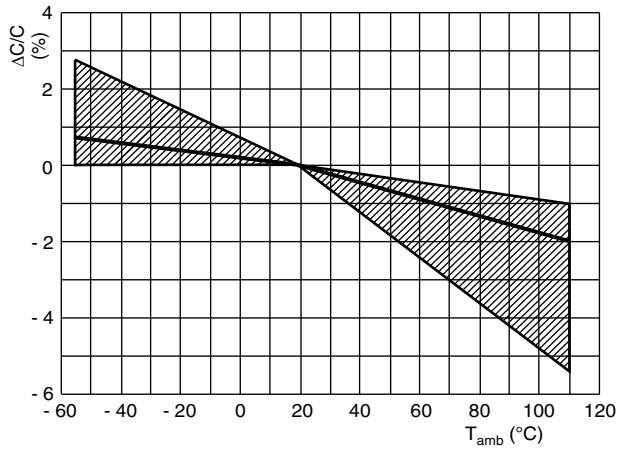

Capacitance as a function of ambient temperature (typical curve)

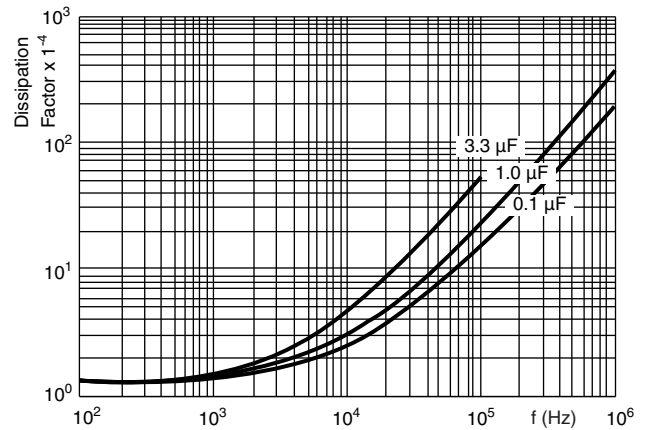

Tangent of loss angle as a function of frequency (typical curve)

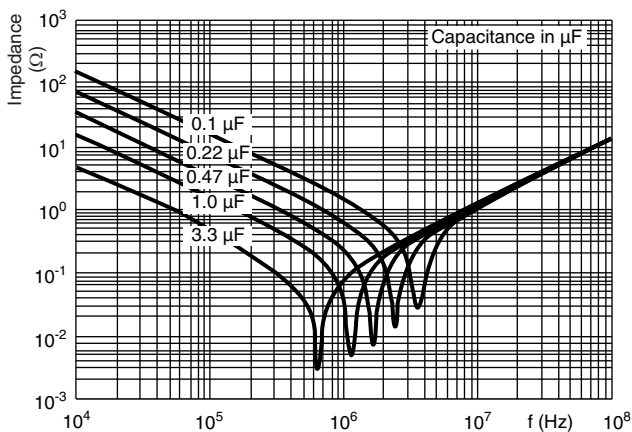

Impedance as a function of frequency (typical curve)

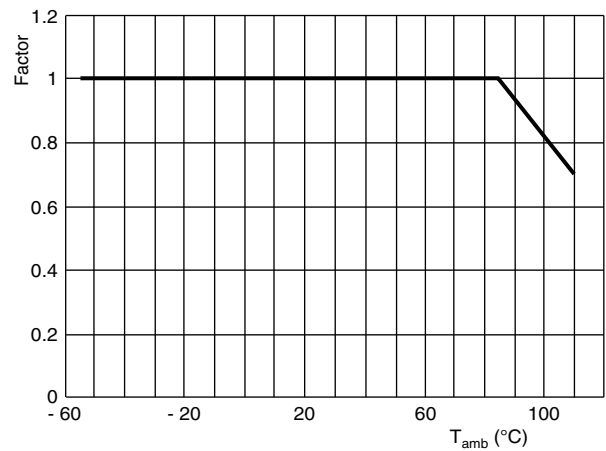

Max. DC and AC voltage as a function of temperature

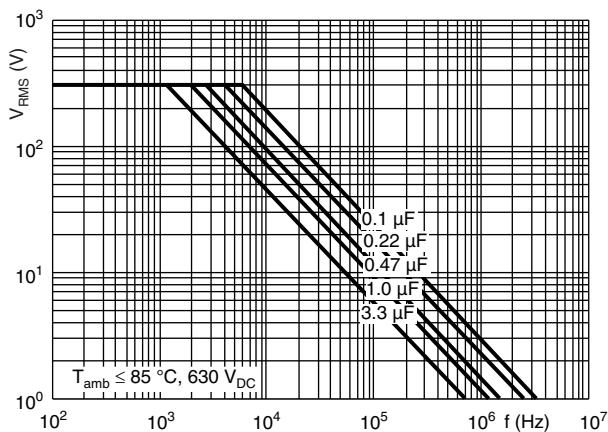

Max. RMS voltage (sinewave) as a function of frequency

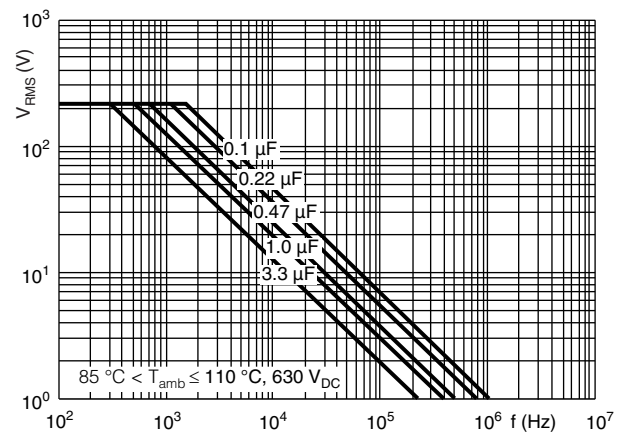

Max. RMS voltage (sinewave) as a function of frequency

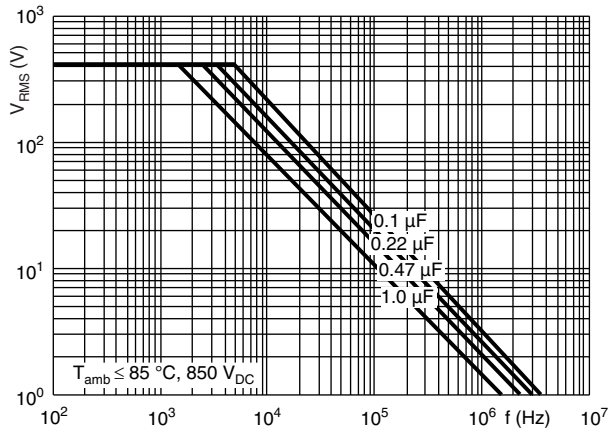

Max. RMS voltage (sinewave) as a function of frequency

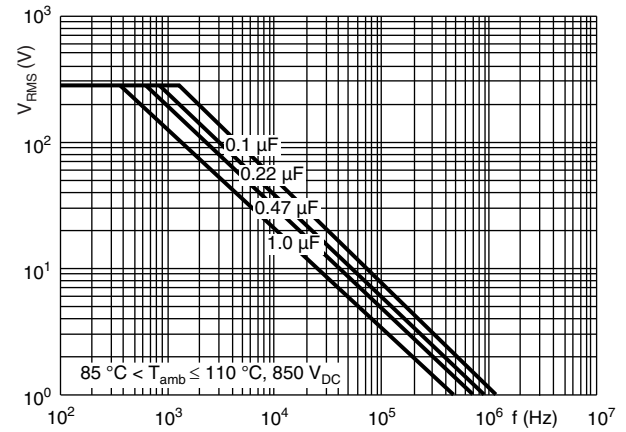

Max. RMS voltage (sinewave) as a function of frequency

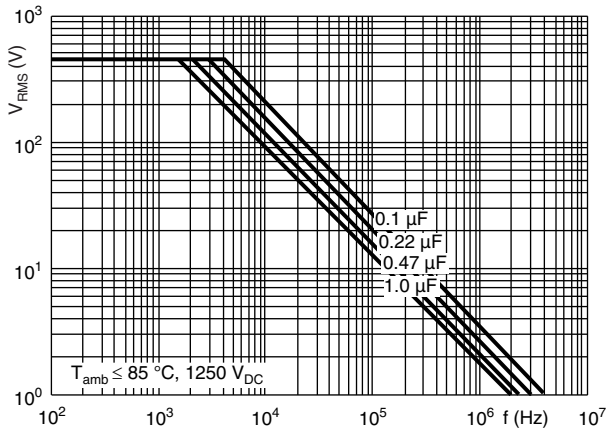

Max. RMS voltage (sinewave) as a function of frequency

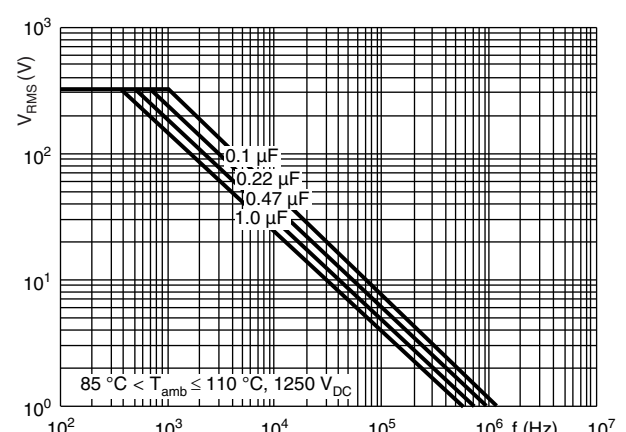

Max. RMS voltage (sinewave) as a function of frequency

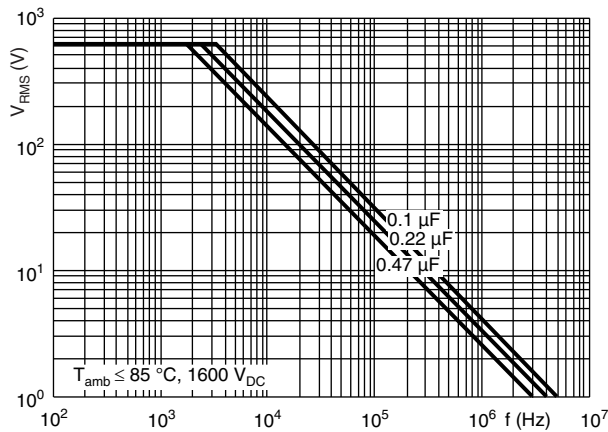

Max. RMS voltage (sinewave) as a function of frequency

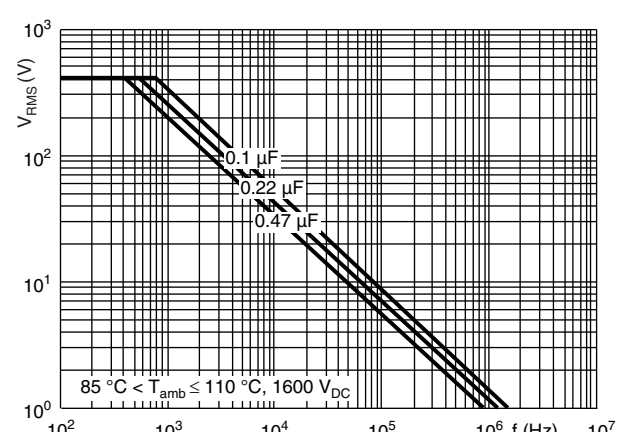

Max. RMS voltage (sinewave) as a function of frequency

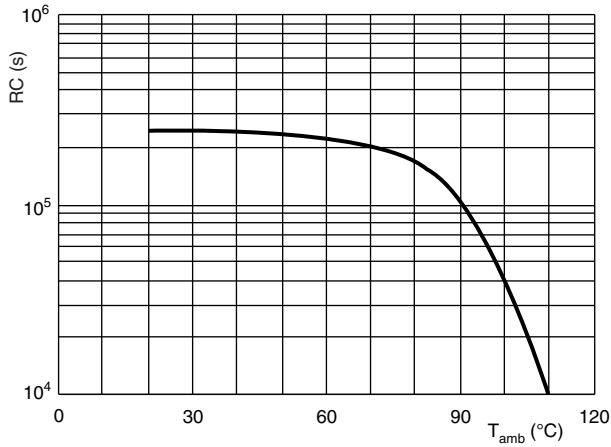

Insulation resistance as a function of ambient temperature (typical curve)

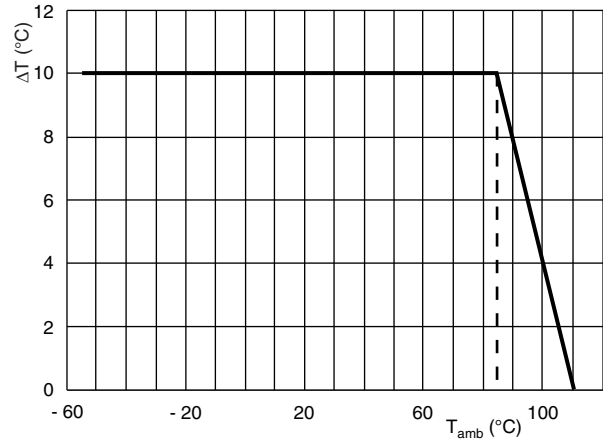

Max. allowed component rise (ΔT) as a function of the ambient temperature (T_{amb})

HEAT CONDUCTIVITY (G) AS A FUNCTION OF CAPACITOR BODY THICKNESS IN mW/°C		
DIAMETER (mm)	HEAT CONDUCTIVITY (mW/°C)	
	PITCH 26.5 mm	PITCH 31.5 mm
7.0	8	-
8.0	10	-
8.5	11	12
9.5	12	-
10.0	13	15
10.5	-	16
11.0	15	17
11.5	-	18
12.0	-	19
12.5	-	20
13.0	-	21
13.5	-	22
14.0	-	23
15.0	-	25
16.0	-	28
16.5	-	29
18.0	-	32
19.0	-	34
19.5	-	36
20.0	-	37
21.5	-	40
23.0	-	44
23.5	-	45
24.0	-	47
25.5	-	51
28.0	-	57

POWER DISSIPATION AND MAXIMUM COMPONENT TEMPERATURE RISE

The power dissipation must be limited in order not to exceed the maximum allowed component temperature rise as a function of the free air ambient temperature.

The power dissipation can be calculated according type detail specification “HQN-384-01/101: Technical Information Film Capacitors with the typical t_{gd} of the curves”.

The component temperature rise (ΔT) can be measured (see section “Measuring the component temperature” for more details) or calculated by $\Delta T = P/G$:

- ΔT = Component temperature rise ($^{\circ}\text{C}$)
- P = Power dissipation of the component (mW)
- G = Heat conductivity of the component ($\text{mW}/^{\circ}\text{C}$)

MEASURING THE COMPONENT TEMPERATURE

A thermocouple must be attached to the capacitor body as in:

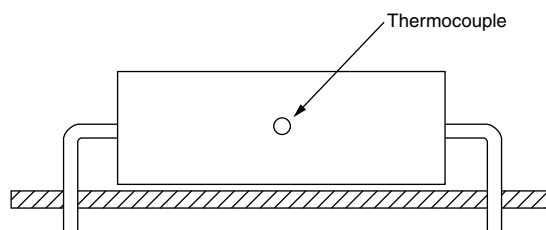

The temperature is measured in unloaded (T_{amb}) and maximum loaded condition (T_{C}).

The temperature rise is given by $\Delta T = T_{\text{C}} - T_{\text{amb}}$.

To avoid radiation or convection, the capacitor should be tested in a wind-free.

APPLICATION NOTE AND LIMITING CONDITIONS

These capacitors are not suitable for mains applications as across-the-line capacitors without additional protection, as described hereunder. These mains applications are strictly regulated in safety standards and therefore electromagnetic interference suppression capacitors conforming the standards must be used.

To select the capacitor for a certain application, the following conditions must be checked:

1. The peak voltage (U_{P}) shall not be greater than the rated DC voltage (U_{RDC}).
2. The peak-to-peak voltage ($U_{\text{P-P}}$) shall not be greater than the maximum ($U_{\text{P-P}}$) to avoid the ionization inception level.
3. The voltage pulse slope (dU/dt) shall not exceed the rated voltage pulse slope in an RC-circuit at rated voltage and without ringing. If the pulse voltage is lower than the rated DC voltage, the rated voltage pulse slope may be multiplied by U_{RDC} and divided by the applied voltage.

For all other pulses following equation must be fulfilled:

$$2 \times \int_0^T \left(\frac{dU}{dt} \right)^2 \times dt < U_{\text{RDC}} \times \left(\frac{dU}{dt} \right)_{\text{rated}}$$

T is the pulse duration.

4. The maximum component surface temperature rise must be lower than the limits (see figure Max. Allowed Component Temperature Rise).
5. Since in circuits used at voltages over 280 V peak-to-peak the risk for an intrinsically active flammability after a capacitor breakdown (short circuit) increases, it is recommended that the power to the component is limited to 100 times the values mentioned in the table “Heat conductivity”.
6. When using these capacitors as across-the-line capacitor in the input filter for mains applications or as series connected with an impedance to the mains the applicant must guarantee that the following conditions are fulfilled in any case (spikes and surge voltages from the mains included).



VOLTAGE CONDITIONS FOR 6 ABOVE		
ALLOWED VOLTAGES	$T_{amb} \leq 85\text{ °C}$	$85\text{ °C} < T_{amb} \leq 110\text{ °C}$
Maximum continuous RMS voltage	U_{RAC}	See “Maximum AC voltage as a function of temperature par. characteristics”
Maximum temporary RMS-overvoltage (< 24 h)	$1.25 \times U_{RAC}$	$0.875 \times U_{RAC}$
Maximum peak voltage (V_{O-P}) (< 2 s)	$1.6 \times U_{RDC}$	$1.1 \times U_{RDC}$

INSPECTION REQUIREMENTS

General Notes

Sub-clause numbers of tests and performance requirements refer to the “Sectional Specification, Publication IEC 60384-17 and Specific Reference Data”.

GROUP C INSPECTION REQUIREMENTS		
SUB-CLAUSE NUMBER AND TEST	CONDITIONS	PERFORMANCE REQUIREMENTS
SUB-GROUP C1A PART OF SAMPLE OF SUB-GROUP C1		
4.1 Dimensions (detail)		As specified in chapter “General Data” of this specification
4.3.1 Initial measurements	Capacitance Tangent of loss angle at 100 kHz	
4.3 Robustness of terminations	Tensile: load 30 N; 10 s Bending: load 15 N; 90°	No visible damage
4.4 Resistance to soldering heat	No pre-drying Method: 1A Solder bath: 280 °C ± 5 °C Duration: 10 s	
4.4.2 Final measurements	Visual examination	No visible damage Legible marking
	Capacitance	$ \Delta C/C \leq 2\%$ of the value measured initially
	Tangent of loss angle	Increase of $\tan \delta$: for $C \leq 470\text{ nF} \leq 0.001 (10 \times 10^{-4})$ for $C > 470\text{ nF} \leq 0.0015 (15 \times 10^{-4})$ Compared to values measured initially
	Insulation resistance	$\geq 50\%$ of values specified in section “Insulation Resistance” of this specification
4.14 Solvent resistance of the marking	Isopropylalcohol at room temperature Method: 1 Rubbing material: cotton wool Immersion time: 5 min ± 0.5 min	No visible damage Legible marking
SUB-GROUP C1B PART OF SAMPLE OF SUB-GROUP C1		
4.6.1 Initial measurements	Capacitance Tangent of loss angle at 100 kHz	
4.6 Rapid change of temperature	qA = -55 °C qB = +110 °C 5 cycles Duration t = 30 min	
	Visual examination	No visible damage



GROUP C INSPECTION REQUIREMENTS		
SUB-CLAUSE NUMBER AND TEST	CONDITIONS	PERFORMANCE REQUIREMENTS
SUB-GROUP C1B PART OF SAMPLE OF SUB-GROUP C1		
4.7 Vibration	Mounting: see section "Mounting" of this specification Procedure B4 Frequency range: 10 Hz to 55 Hz Amplitude: 0.75 mm or Acceleration 98 m/s ² (whichever is less severe) Total duration 6 h	
4.7.2 Final inspection	Visual examination	No visible damage
4.9 Shock	Mounting: see section "Mounting" for more information Pulse shape: half sine Acceleration: 490 m/s ² Duration of pulse: 11 ms	
4.9.3 Final measurements	Visual examination	No visible damage
	Capacitance	$ \Delta C/C \leq 2\%$ of the value measured initially
	Tangent of loss angle	Increase of tan δ : for $C \leq 470 \text{ nF} \leq 0.001 (10 \times 10^{-4})$ for $C > 470 \text{ nF} \leq 0.0015 (15 \times 10^{-4})$ Compared to values measured initially
	Insulation resistance	$\geq 50\%$ of values specified in section "Insulation Resistance" of this specification
SUB-GROUP C1 COMBINED SAMPLE OF SPECIMENS OF SUB-GROUPS C1A AND C1B		
4.10 Climatic sequence		
4.10.2 Dry heat	Temperature: 110 °C Duration: 16 h	
4.10.3 Damp heat cyclic Test Db, first cycle		
4.10.4 Cold	Temperature: -55 °C Duration: 2 h	
4.10.6 Damp heat cyclic Test Db, remaining cycles		
4.10.6.2 Final measurements	Voltage proof = U_{RDC} for 1 min within 15 min after removal from testchambers	No breakdown or flashover
	Visual examination	No visible damage Legible marking
	Capacitance	$ \Delta C/C \leq 3\%$ of the value measured initially
	Tangent of loss angle	Increase of tan δ : for $C \leq 470 \text{ nF} \leq 0.001 (10 \times 10^{-4})$ for $C > 470 \text{ nF} \leq 0.0015 (15 \times 10^{-4})$ Compared to values measured in 4.3.1 or 4.6.1 as applicable
	Insulation resistance	$\geq 50\%$ of values specified in section "Insulation Resistance" of this specification



GROUP C INSPECTION REQUIREMENTS		
SUB-CLAUSE NUMBER AND TEST	CONDITIONS	PERFORMANCE REQUIREMENTS
SUB-GROUP C2		
4.11 Damp heat steady state	Capacitance	
4.11.1 Initial measurements	Tangent of loss angle at 1 kHz	
	Visual examination	No visible damage Legible marking
4.11.3 Final measurements	Voltage proof = U_{RDC} for 1 min within 15 min after removal from testchamber	No breakdown or flashover
	Capacitance	$ \Delta C/C \leq 3\%$ of the value measured in 4.11.1.
	Tangent of loss angle	Increase of $\tan \delta$: for $C \leq 470 \text{ nF} \leq 0.001 (10 \times 10^{-4})$ for $C > 470 \text{ nF} \leq 0.0015 (15 \times 10^{-4})$ Compared to values measured in 4.11.1
	Insulation resistance	$\geq 50\%$ of values specified in section "Insulation Resistance" of this specification
SUB-GROUP C3 A		
4.12.1 Endurance test at 50 Hz alternative voltage	Duration: 2000 h $1.0 \times U_{RAC}$ at 85°C $0.875 \times U_{RAC}$ at 110°C	
4.12.1.1 Initial measurements	Capacitance Tangent of loss angle at 100 kHz	
4.12.1.3 Final measurements	Visual examination	No visible damage Legible marking
	Capacitance	$ \Delta C/C \leq 5\%$ compared to values measured in 4.12.1.1
	Tangent of loss angle	Increase of $\tan \delta$: for $C \leq 470 \text{ nF} \leq 0.001 (10 \times 10^{-4})$ for $C > 470 \text{ nF} \leq 0.0015 (15 \times 10^{-4})$ Compared to values measured in 4.12.1.1
	Insulation resistance	$\geq 50\%$ of values specified in section "Insulation Resistance" of this specification
SUB-GROUP C4		
4.2.6 Temperature characteristics Initial measurement Intermediate measurements	Capacitance Capacitance at -55°C Capacitance at 20°C Capacitance at 110°C	For -55°C to 20°C $0\% \leq \Delta C/C \leq 2.75\%$ or for 20°C to 110°C : $-5.5\% \leq \Delta C/C \leq 0\%$ As specified in section "Capacitance" of this specification
4.13 Charge and discharge	10 000 cycles Charged to U_{RDC} Discharge resistance: $R = \frac{U_n(V_{DC})}{2.5 \times C(dU/dt)}$	
4.13.1 Initial measurements	Capacitance Tangent of loss angle at 100 kHz	
4.13.3 Final measurements	Capacitance	$ \Delta C/C \leq 3\%$ of the value measured in 4.13.1
	Tangent of loss angle	Increase of $\tan \delta$: for $C \leq 470 \text{ nF} \leq 0.001 (10 \times 10^{-4})$ for $C > 470 \text{ nF} \leq 0.0015 (15 \times 10^{-4})$ Compared to values measured in 4.13.1
	Insulation resistance	$\geq 50\%$ of values specified in section "Insulation Resistance" of this specification



Disclaimer

ALL PRODUCT, PRODUCT SPECIFICATIONS AND DATA ARE SUBJECT TO CHANGE WITHOUT NOTICE TO IMPROVE RELIABILITY, FUNCTION OR DESIGN OR OTHERWISE.

Vishay Intertechnology, Inc., its affiliates, agents, and employees, and all persons acting on its or their behalf (collectively, "Vishay"), disclaim any and all liability for any errors, inaccuracies or incompleteness contained in any datasheet or in any other disclosure relating to any product.

Vishay makes no warranty, representation or guarantee regarding the suitability of the products for any particular purpose or the continuing production of any product. To the maximum extent permitted by applicable law, Vishay disclaims (i) any and all liability arising out of the application or use of any product, (ii) any and all liability, including without limitation special, consequential or incidental damages, and (iii) any and all implied warranties, including warranties of fitness for particular purpose, non-infringement and merchantability.

Statements regarding the suitability of products for certain types of applications are based on Vishay's knowledge of typical requirements that are often placed on Vishay products in generic applications. Such statements are not binding statements about the suitability of products for a particular application. It is the customer's responsibility to validate that a particular product with the properties described in the product specification is suitable for use in a particular application. Parameters provided in datasheets and / or specifications may vary in different applications and performance may vary over time. All operating parameters, including typical parameters, must be validated for each customer application by the customer's technical experts. Product specifications do not expand or otherwise modify Vishay's terms and conditions of purchase, including but not limited to the warranty expressed therein.

Hyperlinks included in this datasheet may direct users to third-party websites. These links are provided as a convenience and for informational purposes only. Inclusion of these hyperlinks does not constitute an endorsement or an approval by Vishay of any of the products, services or opinions of the corporation, organization or individual associated with the third-party website. Vishay disclaims any and all liability and bears no responsibility for the accuracy, legality or content of the third-party website or for that of subsequent links.

Vishay products are not designed for use in life-saving or life-sustaining applications or any application in which the failure of the Vishay product could result in personal injury or death unless specifically qualified in writing by Vishay. Customers using or selling Vishay products not expressly indicated for use in such applications do so at their own risk. Please contact authorized Vishay personnel to obtain written terms and conditions regarding products designed for such applications.

No license, express or implied, by estoppel or otherwise, to any intellectual property rights is granted by this document or by any conduct of Vishay. Product names and markings noted herein may be trademarks of their respective owners.